

JP1 Version 13

**JP1/Automatic Job Management System 3
Command Reference**

3021-3-L49-10(E)

Notices

■ Relevant program products

For details about the applicable OS versions, and the service packs and patches required for JP1/Automatic Job Management System 3, see the *Release Notes*.

JP1/Automatic Job Management System 3 - Manager (For Windows):

P-2A12-3KDL JP1/Automatic Job Management System 3 - Manager version 13-10

The above product includes the following:

P-CC2A12-4KDL JP1/Automatic Job Management System 3 - Manager version 13-10 (For Windows Server 2022, Windows Server 2019, Windows Server 2016)

P-CC2912-39DL JP1/Automatic Job Management System 3 - Web Console version 13-10 (For Windows Server 2022, Windows Server 2019, Windows Server 2016)

P-CC8412-39DL JP1/Automatic Job Management System 3 - Web Console version 13-10 (For Linux 7, Linux 8, Linux 9, Oracle Linux 7, Oracle Linux 8, Oracle Linux 9, SUSE Linux 12, SUSE Linux 15)

P-CC2A12-3NDL JP1/Automatic Job Management System 3 - Print Option Manager version 13-10 (For Windows Server 2022, Windows Server 2019, Windows Server 2016)

P-CC2A2C-6LDL JP1/Base version 13-10 (For Windows Server 2022, Windows Server 2019, Windows Server 2016)

JP1/Automatic Job Management System 3 - Manager (For Linux):

P-8412-3KDL JP1/Automatic Job Management System 3 - Manager version 13-10

The above product includes the following:

P-CC8412-4KDL JP1/Automatic Job Management System 3 - Manager version 13-10 (For Linux 7, Linux 8, Linux 9, Oracle Linux 7, Oracle Linux 8, Oracle Linux 9, SUSE Linux 12, SUSE Linux 15)

P-CC2912-39DL JP1/Automatic Job Management System 3 - Web Console version 13-10 (For Windows Server 2022, Windows Server 2019, Windows Server 2016)

P-CC8412-39DL JP1/Automatic Job Management System 3 - Web Console version 13-10 (For Linux 7, Linux 8, Linux 9, Oracle Linux 7, Oracle Linux 8, Oracle Linux 9, SUSE Linux 12, SUSE Linux 15)

P-CC8412-3NDL JP1/Automatic Job Management System 3 - Print Option Manager version 13-10 (For Linux 7, Linux 8, Linux 9, Oracle Linux 7, Oracle Linux 8, Oracle Linux 9, SUSE Linux 12, SUSE Linux 15)

P-CC842C-6LDL JP1/Base version 13-10 (For Linux 7, Linux 8, Linux 9, Oracle Linux 7, Oracle Linux 8, Oracle Linux 9, SUSE Linux 12, SUSE Linux 15)

JP1/Automatic Job Management System 3 - Agent (For Windows):

P-2A12-33DL JP1/Automatic Job Management System 3 - Agent version 13-10

The above product includes the following:

P-CC2A12-43DL JP1/Automatic Job Management System 3 - Agent version 13-10 (For Windows Server 2022, Windows Server 2019, Windows Server 2016)

P-CC2A2C-6LDL JP1/Base version 13-10 (For Windows Server 2022, Windows Server 2019, Windows Server 2016)

JP1/Automatic Job Management System 3 - Agent (For AIX):

P-1M12-33DL JP1/Automatic Job Management System 3 - Agent version 13-10

The above product includes the following:

P-CC1M12-43DL JP1/Automatic Job Management System 3 - Agent version 13-10 (For AIX)

P-CC1M2C-6LDL JP1/Base version 13-10 (For AIX)

JP1/Automatic Job Management System 3 - Agent (For Linux):

P-8412-33DL JP1/Automatic Job Management System 3 - Agent version 13-10

The above product includes the following:

P-CC8412-43DL JP1/Automatic Job Management System 3 - Agent version 13-10 (For Linux 7, Linux 8, Linux 9, Oracle Linux 7, Oracle Linux 8, Oracle Linux 9, SUSE Linux 12, SUSE Linux 15)

P-CC842C-6LDL JP1/Base version 13-10 (For Linux 7, Linux 8, Linux 9, Oracle Linux 7, Oracle Linux 8, Oracle Linux 9, SUSE Linux 12, SUSE Linux 15)

JP1/Automatic Job Management System 3 - Agent Minimal Edition (For Windows):

P-2A12-38DL JP1/Automatic Job Management System 3 - Agent Minimal Edition version 13-10

The above product includes the following:

P-CC2A12-48DL JP1/Automatic Job Management System 3 - Agent Minimal Edition version 13-10 (For Windows Server 2022, Windows Server 2019, Windows Server 2016)

P-CC2A2C-6LDL JP1/Base version 13-10 (For Windows Server 2022, Windows Server 2019, Windows Server 2016)

JP1/Automatic Job Management System 3 - Agent Minimal Edition (For Linux):

P-8412-38DL JP1/Automatic Job Management System 3 - Agent Minimal Edition version 13-10

The above product includes the following:

P-CC8412-48DL JP1/Automatic Job Management System 3 - Agent Minimal Edition version 13-10 (For Linux 7, Linux 8, Linux 9, Oracle Linux 7, Oracle Linux 8, Oracle Linux 9, SUSE Linux 12, SUSE Linux 15)

P-CC842C-6LDL JP1/Base version 13-10 (For Linux 7, Linux 8, Linux 9, Oracle Linux 7, Oracle Linux 8, Oracle Linux 9, SUSE Linux 12, SUSE Linux 15)

JP1/Automatic Job Management System 3 - View (For Windows):

P-2A12-34DL JP1/Automatic Job Management System 3 - View version 13-10

The above product includes the following:

P-CC2A12-44DL JP1/Automatic Job Management System 3 - View version 13-10 (For Windows Server 2022, Windows Server 2019, Windows Server 2016, Windows 11, Windows 10)

P-CC2A12-3MDL JP1/Automatic Job Management System 3 - Print Option version 13-10 (For Windows Server 2022, Windows Server 2019, Windows Server 2016, Windows 11, Windows 10)

■ Trademarks

HITACHI, JP1, Job Management Partner 1, uCosminexus, HiRDB are either trademarks or registered trademarks of Hitachi, Ltd. in Japan and other countries.

Other company and product names mentioned in this document may be the trademarks of their respective owners.

This product includes software developed by the Apache Software Foundation (<http://www.apache.org/>).

Portions of this software were developed at the National Center for Supercomputing Applications (NCSA) at the University of Illinois at Urbana-Champaign.

This product includes software developed by the University of California, Berkeley and its contributors.

This software contains code derived from the RSA Data Security Inc. MD5 Message-Digest Algorithm, including various modifications by Spyglass Inc., Carnegie Mellon University, and Bell Communications Research, Inc (Bellcore).

Regular expression support is provided by the PCRE library package, which is open source software, written by Philip Hazel, and copyright by the University of Cambridge, England.

The original software is available from <ftp://ftp.csx.cam.ac.uk/pub/software/programming/pcre/>

1. This product includes software developed by the OpenSSL Project for use in the OpenSSL Toolkit. (<http://www.openssl.org/>)

2. This product includes cryptographic software written by Eric Young (ey@cryptsoft.com)

3. This product includes software written by Tim Hudson (tjh@cryptsoft.com)

4. This product includes the OpenSSL Toolkit software used under OpenSSL License and Original SSLeay License. OpenSSL License and Original SSLeay License are as follow:

LICENSE ISSUES

The OpenSSL toolkit stays under a double license, i.e. both the conditions of the OpenSSL License and the original SSLeay license apply to the toolkit.

See below for the actual license texts.

OpenSSL License

/* =====

* Copyright (c) 1998-2019 The OpenSSL Project. All rights reserved.

*

* Redistribution and use in source and binary forms, with or without
* modification, are permitted provided that the following conditions
* are met:

*

* 1. Redistributions of source code must retain the above copyright
* notice, this list of conditions and the following disclaimer.

*

* 2. Redistributions in binary form must reproduce the above copyright
* notice, this list of conditions and the following disclaimer in
* the documentation and/or other materials provided with the
* distribution.

*

* 3. All advertising materials mentioning features or use of this
* software must display the following acknowledgment:
* "This product includes software developed by the OpenSSL Project
* for use in the OpenSSL Toolkit. (<http://www.openssl.org/>)"

*

* 4. The names "OpenSSL Toolkit" and "OpenSSL Project" must not be used to
* endorse or promote products derived from this software without
* prior written permission. For written permission, please contact
* openssl-core@openssl.org.

```

*
* 5. Products derived from this software may not be called "OpenSSL"
* nor may "OpenSSL" appear in their names without prior written
* permission of the OpenSSL Project.
*
* 6. Redistributions of any form whatsoever must retain the following
* acknowledgment:
* "This product includes software developed by the OpenSSL Project
* for use in the OpenSSL Toolkit (http://www.openssl.org/)"
*
* THIS SOFTWARE IS PROVIDED BY THE OpenSSL PROJECT ``AS IS" AND ANY
* EXPRESSED OR IMPLIED WARRANTIES, INCLUDING, BUT NOT LIMITED TO, THE
* IMPLIED WARRANTIES OF MERCHANTABILITY AND FITNESS FOR A PARTICULAR
* PURPOSE ARE DISCLAIMED. IN NO EVENT SHALL THE OpenSSL PROJECT OR
* ITS CONTRIBUTORS BE LIABLE FOR ANY DIRECT, INDIRECT, INCIDENTAL,
* SPECIAL, EXEMPLARY, OR CONSEQUENTIAL DAMAGES (INCLUDING, BUT
* NOT LIMITED TO, PROCUREMENT OF SUBSTITUTE GOODS OR SERVICES;
* LOSS OF USE, DATA, OR PROFITS; OR BUSINESS INTERRUPTION)
* HOWEVER CAUSED AND ON ANY THEORY OF LIABILITY, WHETHER IN CONTRACT,
* STRICT LIABILITY, OR TORT (INCLUDING NEGLIGENCE OR OTHERWISE)
* ARISING IN ANY WAY OUT OF THE USE OF THIS SOFTWARE, EVEN IF ADVISED
* OF THE POSSIBILITY OF SUCH DAMAGE.
* =====
*
* This product includes cryptographic software written by Eric Young
* (eay@cryptsoft.com). This product includes software written by Tim
* Hudson (tjh@cryptsoft.com).
*
*/
Original SSLeay License
-----
/* Copyright (C) 1995-1998 Eric Young (eay@cryptsoft.com)
* All rights reserved.
*
* This package is an SSL implementation written
* by Eric Young (eay@cryptsoft.com).
* The implementation was written so as to conform with Netscapes SSL.
*
* This library is free for commercial and non-commercial use as long as
* the following conditions are aheared to. The following conditions
* apply to all code found in this distribution, be it the RC4, RSA,
* lhash, DES, etc., code; not just the SSL code. The SSL documentation

```

- * included with this distribution is covered by the same copyright terms
- * except that the holder is Tim Hudson (tjh@cryptsoft.com).
- *
- * Copyright remains Eric Young's, and as such any Copyright notices in
- * the code are not to be removed.
- * If this package is used in a product, Eric Young should be given attribution
- * as the author of the parts of the library used.
- * This can be in the form of a textual message at program startup or
- * in documentation (online or textual) provided with the package.
- *
- * Redistribution and use in source and binary forms, with or without
- * modification, are permitted provided that the following conditions
- * are met:
- * 1. Redistributions of source code must retain the copyright
- * notice, this list of conditions and the following disclaimer.
- * 2. Redistributions in binary form must reproduce the above copyright
- * notice, this list of conditions and the following disclaimer in the
- * documentation and/or other materials provided with the distribution.
- * 3. All advertising materials mentioning features or use of this software
- * must display the following acknowledgement:
- * "This product includes cryptographic software written by
- * Eric Young (eay@cryptsoft.com)"
- * The word 'cryptographic' can be left out if the routines from the library
- * being used are not cryptographic related :-).
- * 4. If you include any Windows specific code (or a derivative thereof) from
- * the apps directory (application code) you must include an acknowledgement:
- * "This product includes software written by Tim Hudson (tjh@cryptsoft.com)"
- *
- * THIS SOFTWARE IS PROVIDED BY ERIC YOUNG ``AS IS" AND
- * ANY EXPRESS OR IMPLIED WARRANTIES, INCLUDING, BUT NOT LIMITED TO, THE
- * IMPLIED WARRANTIES OF MERCHANTABILITY AND FITNESS FOR A PARTICULAR PURPOSE
- * ARE DISCLAIMED. IN NO EVENT SHALL THE AUTHOR OR CONTRIBUTORS BE LIABLE
- * FOR ANY DIRECT, INDIRECT, INCIDENTAL, SPECIAL, EXEMPLARY, OR CONSEQUENTIAL
- * DAMAGES (INCLUDING, BUT NOT LIMITED TO, PROCUREMENT OF SUBSTITUTE GOODS
- * OR SERVICES; LOSS OF USE, DATA, OR PROFITS; OR BUSINESS INTERRUPTION)
- * HOWEVER CAUSED AND ON ANY THEORY OF LIABILITY, WHETHER IN CONTRACT, STRICT
- * LIABILITY, OR TORT (INCLUDING NEGLIGENCE OR OTHERWISE) ARISING IN ANY WAY
- * OUT OF THE USE OF THIS SOFTWARE, EVEN IF ADVISED OF THE POSSIBILITY OF
- * SUCH DAMAGE.
- *
- * The licence and distribution terms for any publically available version or
- * derivative of this code cannot be changed. i.e. this code cannot simply be

* copied and put under another distribution licence

* [including the GNU Public Licence.]

*/

This product includes the OpenSSL library.

The OpenSSL library is licensed under Apache License, Version 2.0.

<https://www.apache.org/licenses/LICENSE-2.0>

This product includes software developed by the Java Apache Project for use in the Apache JServ servlet engine project (<http://java.apache.org/>).

This product includes software developed by IAIK of Graz University of Technology.

This product includes software developed by Daisuke Okajima and Kohsuke Kawaguchi (<http://relaxngcc.sf.net/>).

This product includes software developed by Andy Clark.

Java is a registered trademark of Oracle and/or its affiliates.



■ Microsoft product name abbreviations

This manual uses the following abbreviations for Microsoft product names.

| Abbreviation | Full name or meaning |
|----------------------|--|
| Excel | Microsoft(R) Excel |
| | Microsoft(R) Office Excel |
| Exchange Server | Microsoft(R) Exchange 2000 Enterprise Server |
| | Microsoft(R) Exchange 2000 Server |
| | Microsoft(R) Exchange Server |
| Internet Explorer | Windows(R) Internet Explorer(R) |
| Microsoft Edge | Microsoft(R) Edge |
| Microsoft SQL Server | Microsoft(R) SQL Server |
| | Microsoft(R) SQL Server Enterprise Edition |
| MSMQ | Microsoft(R) Message Queue Server |

| Abbreviation | | Full name or meaning |
|---------------------|--------------|--|
| Outlook | Outlook 2016 | Microsoft(R) Office Outlook(R) 2016 |
| | Outlook 2019 | Microsoft(R) Office Outlook(R) 2019 |
| | Outlook 2021 | Microsoft(R) Office Outlook(R) 2021 |
| Outlook Express | | Microsoft(R) Outlook(R) Express |
| Windows 10 | | Windows(R) 10 Enterprise |
| | | Windows(R) 10 Pro |
| | | Windows(R) 10 Home |
| Windows 11 | | Windows(R) 11 Enterprise |
| | | Windows(R) 11 Pro |
| | | Windows(R) 11 Home |
| Windows Server 2016 | | Microsoft(R) Windows Server(R) 2016 Datacenter |
| | | Microsoft(R) Windows Server(R) 2016 Standard |
| Windows Server 2019 | | Microsoft(R) Windows Server(R) 2019 Datacenter |
| | | Microsoft(R) Windows Server(R) 2019 Standard |
| Windows Server 2022 | | Microsoft(R) Windows Server(R) 2022 Datacenter |
| | | Microsoft(R) Windows Server(R) 2022 Standard |

Windows is sometimes used generically, referring to Windows Server 2022, Windows Server 2019, Windows Server 2016, Windows 11, and Windows 10.

■ Restrictions

Information in this document is subject to change without notice and does not represent a commitment on the part of Hitachi. The software described in this manual is furnished according to a license agreement with Hitachi. The license agreement contains all of the terms and conditions governing your use of the software and documentation, including all warranty rights, limitations of liability, and disclaimers of warranty.

Material contained in this document may describe Hitachi products not available or features not available in your country.

No part of this material may be reproduced in any form or by any means without permission in writing from the publisher.

■ Issued

Sep. 2024: 3021-3-L49-10(E)

■ Copyright

Copyright (C) 2023, 2024, Hitachi, Ltd.

Copyright (C) 2023, 2024, Hitachi Solutions, Ltd.

Summary of amendments

For details about the amendments, see the manual *JP1/Automatic Job Management System 3 Overview*.

Preface

This manual describes the syntax of the commands used in JP1/Automatic Job Management System 3 (abbreviated hereafter to *JP1/AJS3*), the details of the information definition files, and the syntax of and how to use the APIs.

For details on the prerequisites before reading this manual, see the manual *JP1/Automatic Job Management System 3 Overview*.

■ Organization of this manual

This manual organized into the following parts. The manual is a common reference for all supported operating systems. Any platform-dependent differences in functionality are noted in the manual.

PART1: Command

PART 1 describes the JP1/AJS3 commands.

PART2: Information Definition Files

PART 2 describes how to create various information definition files.

PART3: API

PART 3 describes the APIs used to operate JP1/AJS3.

Contents

| | |
|-----------------------|----|
| Notices | 2 |
| Summary of amendments | 9 |
| Preface | 10 |

Part 1: Command

| | | |
|----------|---|-----------|
| 1 | Overview of Commands | 20 |
| 1.1 | Command syntax | 21 |
| 1.1.1 | Specifying a command | 21 |
| 1.1.2 | Specifying a unit name | 22 |
| 1.1.3 | Specifying a unit name in a command when using a planning group | 23 |
| 1.1.4 | Specifying wildcard characters | 26 |
| 1.1.5 | Specifying an IPv6 address | 26 |
| 1.1.6 | Symbols used in command usage description | 26 |
| 1.1.7 | Remote execution of a command | 27 |
| 1.1.8 | Environment variables for command execution | 28 |
| 1.2 | Notes on using commands | 30 |
| 1.2.1 | Notes common to all commands | 30 |
| 1.2.2 | Notes on commands related to the scheduler service | 30 |
| 1.2.3 | Notes on commands that consume a large amount of system resources or commands that perform mutually conflicting processes | 30 |
| 1.2.4 | Notes on operation in the console for executing commands | 31 |
| 1.2.5 | Cautionary notes when UTF-8 is used as the character encoding | 31 |
| 1.2.6 | Note on using commands in Windows | 32 |
| 1.2.7 | Note on using commands in Solaris 11 | 32 |
| 1.2.8 | Note on using commands in HP-UX, AIX, or Linux | 33 |
| 1.3 | Linkage with other programs | 34 |
| 1.3.1 | Linkage with JP1/OJE for VOS3 | 34 |
| 1.3.2 | Linkage with AS/400 (JP1/OJE for Midrange Computer) | 35 |
| 1.4 | Environment variables | 36 |
| 1.4.1 | Environment variables used to execute JP1/AJS3 commands | 36 |
| 1.4.2 | Environment variables set when a job is executed from JP1/AJS3 | 38 |
| 1.5 | Commands | 43 |
| 1.5.1 | Commands used to set up JP1/AJS3 | 43 |
| 1.5.2 | Commands used to customize environments | 45 |
| 1.5.3 | Commands used to control JP1/AJS3 | 46 |
| 1.5.4 | Commands used to manipulate units | 49 |

- 1.5.5 Commands used to operate execution agents 53
- 1.5.6 Commands used to execute jobs 54
- 1.5.7 Commands used to manipulate the embedded database 55
- 1.5.8 Command used to manipulate the external database 56
- 1.5.9 Commands used when an error occurs 57
- 1.5.10 Commands used during special operation 57
- 1.6 Prerequisites to use commands 63

2 Commands Used during Setup 70

- ajs_adapter_setup 71
- ajsatsetup 72
- ajschksetup 75
- ajscnvdbexport 78
- ajscnvdbimport 80
- ajsembdbbuild 82
- ajsembdbidlist 94
- ajsembdbinstl 100
- ajsembdbsetup 103
- ajsembdbuninstl 110
- ajsembdbunset 112
- ajsssetup 115
- ajssysctlsetup 117
- ajswebsetup 120
- jajs_config 123
- jajs_migrate 126
- jajs_rpenvexport 133
- jajs_rpenvimport 136
- jajs_rpsite 140
- jajs_setup 145
- jajs_setup_cluster 162
- jpomailrecv (UNIX only) 174
- jpqregguestuser 176
- jpqreguser 178

3 Commands Used for Normal Operations 182

- ajs 183
- ajs2collectcore (UNIX only) 187
- ajsagtadd 193
- ajsagtalt 202
- ajsagtcheck 209
- ajsagtdel 212
- ajsagtprint 216
- ajsagtshow 220
- ajsalter 229
- ajsatmstart (Linux only) 232
- ajsatmstop (Linux only) 233

ajsatstart (Linux only) 234
ajsatstatus (Linux only) 235
ajsatstop (Linux only) 236
ajsbackup 237
ajsbkudel 241
ajscalendar 243
ajscalutil 250
ajschange 262
ajschgjob 279
ajschgnet 317
ajschgstat 332
ajschkdef 338
ajschkstart (UNIX only) 349
ajschkstop (UNIX only) 351
ajschktrsetsz 353
ajscopy 354
ajsdefine 359
ajsdelete 363
ajsembdbaddarea 366
ajsembdbaddlog 370
ajsembdbbackup 374
ajsembdbcancel 380
ajsembdboplog 383
ajsembdbreclaim 389
ajsembdbrorg 395
ajsembdbrstr 399
ajsembdbstart 406
ajsembdbstatus 409
ajsembdbstop 446
ajsentry 449
ajsexport 456
ajsfxbcstatus 458
ajsgtroot 460
ajsimport 462
ajsintrpt 464
ajskill 467
ajsleave 471
ajslogprint 477
ajsname 481
ajsplan 484
ajsplanout 497
ajsprint 501
ajsprofalter 540
ajsprofstatus 543
ajsrelease 546
ajsrerun 554
ajsreport 560

ajsrestore 575
ajsgexport 579
ajsgimport 582
ajsschedule 586
ajsshow 589
ajsstart 631
ajsstatus 635
ajsstop 649
ajssuspend 655
ajssysctlstart (UNIX only) 658
ajssysctlstatus 660
ajssysctlstop (UNIX only) 665
ajstrsetsz 667
ajswebtz (Linux only) 669
ajswebtz.bat (Windows only) 671
jajs_dbbackup 673
jajs_dbrestore 677
jajs_extdb 681
jajs_hstd 686
jajs_hstd_stop 688
jajs_killall.cluster (UNIX only) 690
jajs_log or _04 (UNIX only) 692
jajs_log.bat or _04.bat (Windows only) 705
jajs_pmtcon 718
jajsshowadminusr (UNIX only) 721
jajs_spmd 722
jajs_spmd_status 727
jajs_spmd_stop 733
jajs_start (UNIX only) 737
jajs_start.cluster (UNIX only) 739
jajs_status 742
jajs_stop (UNIX only) 754
jajs_stop.cluster (UNIX only) 756
jajs_web (Linux only) 758
jajs_web_stop (Linux only) 760
jp1exec (Windows only) 761
jp1exit (Windows only) 764
jpoagoec 766
jpoagtjobshow 769
jpomailprof (Windows only) 773
jpomanevreset 782
jpomanevshow 790
jpomanjobshow 794
jpqdbcond 798

4 Commands Used for Special Operation 806

ajslocaldate 807

ajsqlalter 810
ajsqlattach 813
ajsqldetach 815
ajsqlexecsetsz 817
ajsqlftpstart (UNIX only) 819
ajsqlftpstop 820
ajsqlsetup 822
ajsqlstart (UNIX only) 827
ajsqlstatus 828
ajsqlstop 831
ajsqltrsetsz 833
jajs_maintain 835
jajsacfg (Windows only) 840
jpqagttadd 841
jpqagtalt 844
jpqagtdel 847
jpqagtlink 850
jpqagtshow 853
jpqagtunlink 857
jpqendjobshow 859
jpqexport 864
jpqimport 866
jpqjobalt 874
jpqjobcan 877
jpqjobdel 880
jpqjobget 882
jpqjobmove 888
jpqjobshow 892
jpqjobsub 896
jpqqeadd 906
jpqqealt 909
jpqqeaclose 913
jpqqedel 916
jpqqeopen 918
jpqqeshow 921
jpqresadd 926
jpqresdel 928
jpqresshow 930

Part 2: Information Definition Files

5 **Creating Information Definition Files** **934**

- 5.1 Creating a unit definition file 935
- 5.1.1 Format of unit definition files 935
- 5.1.2 Notes on defining unit definition parameters 936
- 5.2 Definition format and parameters 939

- 5.2.1 Attribute definition 939
- 5.2.2 Unit configuration definition 941
- 5.2.3 Job group definition 942
- 5.2.4 Jobnet definition 945
- 5.2.5 Manager unit definition 954
- 5.2.6 UNIX/PC job definition 954
- 5.2.7 QUEUE job definition 962
- 5.2.8 Judgment job definition 967
- 5.2.9 Job definition for monitoring JP1 event reception 971
- 5.2.10 File monitoring job definition 975
- 5.2.11 Email reception monitoring job definition 978
- 5.2.12 Job definition for monitoring message-queue message reception 982
- 5.2.13 MSMQ message reception monitoring job definition 984
- 5.2.14 Log-file monitoring job definition 987
- 5.2.15 Windows event-log monitoring job definition 991
- 5.2.16 Execution-interval control job definition 995
- 5.2.17 JP1 event sending job definition 997
- 5.2.18 Email sending job definition 1001
- 5.2.19 Message-queue message sending job definition 1005
- 5.2.20 MSMQ message sending job definition 1008
- 5.2.21 OpenView Status Report job definition 1011
- 5.2.22 Local power control job definition 1013
- 5.2.23 Remote power control job definition 1016
- 5.2.24 UNIX/PC custom job definition 1019
- 5.2.25 Passing information setting job definition 1028
- 5.2.26 Flexible job definition 1029
- 5.2.27 HTTP Connection job definition 1034
- 5.2.28 Custom event job definition 1041
- 5.2.29 Start condition definition 1043
- 5.2.30 Specifying the definition of a jobnet connector 1044
- 5.3 Examples of specifying unit definition parameters 1047
 - 5.3.1 Example of defining a job group 1047
 - 5.3.2 Example of defining a jobnet 1048
 - 5.3.3 Example of defining a job 1048
 - 5.3.4 Example of defining a related nested jobnet 1049
 - 5.3.5 Example of defining start conditions for the root jobnet 1049
 - 5.3.6 Example of defining a jobnet connector 1050
- 5.4 Creating a schedule information file 1053
 - 5.4.1 Format of the schedule information file 1053
 - 5.4.2 Notes on defining a schedule information parameter 1056
- 5.5 Example of a schedule information parameter 1057

- 5.6 File of registered execution-schedule information for jobnets 1059
- 5.6.1 Format of a file of registered execution-schedule information for jobnets 1059

Part 3: API

6 Overview of APIs 1065

- 6.1 Workflow for using an API 1066
- 6.2 Authentication when using an API 1068
- 6.3 Data types usable for an API 1069
- 6.4 Request format 1071
 - 6.4.1 Details of the values to be specified 1071
 - 6.4.2 Example of specifying a request 1073
- 6.5 Response format 1074
 - 6.5.1 Format of a response when the response is successfully acquired 1074
 - 6.5.2 Response format when an error occurs in an API 1075
 - 6.5.3 Response format when an error occurs for a reason other than APIs 1077
- 6.6 API configuration components 1078
 - 6.6.1 List of API configuration components 1078
- 6.7 Notes on using APIs 1084
 - 6.7.1 Workload on JP1/AJS3 - Manager 1084
 - 6.7.2 Setting SSL communication 1085
 - 6.7.3 JP1 user permissions for the operation-target unit 1085
 - 6.7.4 Characters that can be used in API arguments 1085
 - 6.7.5 Number of bytes of API arguments 1085
 - 6.7.6 Managing the execution ID of the operation-target unit 1086
 - 6.7.7 Status code if the request format is invalid 1086
 - 6.7.8 Language type of maintenance information and stack trace information in the message body 1086
 - 6.7.9 Response message body 1086
 - 6.7.10 Connection permission for the JP1/AJS3 - Manager instances to which requests are to be issued 1087
 - 6.7.11 Notes on upgrading from a version earlier than 12-60 1087

7 Details of API Configuration Components 1088

- 7.1 Details of APIs 1089
 - 7.1.1 Unit list acquisition API 1089
 - 7.1.2 Unit information acquisition API 1096
 - 7.1.3 Execution result details acquisition API 1099
 - 7.1.4 Wait condition status list acquisition API 1101
 - 7.1.5 Planned execution registration API 1104
 - 7.1.6 Fixed execution registration API 1107
 - 7.1.7 Immediate execution registration API 1115
 - 7.1.8 Registration cancellation API 1118
 - 7.1.9 Change hold attribute API 1122

| | | |
|--------|--|------|
| 7.1.10 | Change delay monitor API | 1124 |
| 7.1.11 | Change job status API | 1130 |
| 7.1.12 | Change plan (change time) API | 1133 |
| 7.1.13 | Change plan (execute immediately) API | 1139 |
| 7.1.14 | Change plan (execution prohibited) API | 1141 |
| 7.1.15 | Change plan (release change) API | 1143 |
| 7.1.16 | Interrupt API | 1146 |
| 7.1.17 | Kill API | 1148 |
| 7.1.18 | Rerun API | 1150 |
| 7.1.19 | Wait status change API | 1153 |
| 7.1.20 | Execution order control method change API | 1155 |
| 7.1.21 | Execution agent status list acquisition API | 1157 |
| 7.1.22 | Execution agent status acquisition API | 1159 |
| 7.1.23 | Execution agent definition acquisition API | 1161 |
| 7.1.24 | Execution agent addition API | 1164 |
| 7.1.25 | Execution agent deletion API | 1167 |
| 7.1.26 | Execution agent reconfiguration API | 1169 |
| 7.1.27 | API to change the job transfer restriction status of an execution agent | 1172 |
| 7.1.28 | Execution agent status change API | 1175 |
| 7.1.29 | API to check the communication status of the job distribution delay reduction function | 1177 |
| 7.1.30 | Execution agent group status list acquisition API | 1180 |
| 7.1.31 | Execution agent group definition acquisition API | 1182 |
| 7.1.32 | Execution agent group addition API | 1184 |
| 7.1.33 | Execution agent group deletion API | 1187 |
| 7.1.34 | Execution agent group reconfiguration API | 1189 |
| 7.1.35 | API to change the job transfer restriction status of an execution agent group | 1191 |
| 7.1.36 | API to exclude or add execution agents, or to change their priority levels | 1194 |
| 7.1.37 | Version information acquisition API | 1197 |
| 7.1.38 | JP1/AJS3 - Manager protocol version acquisition API | 1200 |
| 7.2 | Details of resources | 1203 |
| 7.2.1 | Resource for status monitoring | 1203 |
| 7.2.2 | Wait resource | 1203 |
| 7.3 | Details of objects | 1208 |
| 7.3.1 | Unit definition information object | 1208 |
| 7.3.2 | Status information object | 1211 |
| 7.3.3 | Release information object | 1217 |
| 7.3.4 | Start condition parameter object | 1217 |
| 7.3.5 | Macro variable object | 1218 |
| 7.3.6 | Execution agent operation result object | 1219 |
| 7.3.7 | Execution agent definition information object | 1221 |
| 7.3.8 | Execution agent status object | 1222 |

| | | |
|--------|---|------|
| 7.4 | Details of constants | 1225 |
| 7.4.1 | Constants commonly used by APIs | 1225 |
| 7.4.2 | Constants used by the unit list acquisition API | 1227 |
| 7.4.3 | Constants used by the execution registration API | 1231 |
| 7.4.4 | Constants used by the unit definition information object | 1232 |
| 7.4.5 | Constants used by the status information object | 1233 |
| 7.4.6 | Constants used by the release information object | 1236 |
| 7.4.7 | Constants used by the start condition parameter object | 1236 |
| 7.4.8 | Constants used by the change hold attribute API | 1237 |
| 7.4.9 | Constants used by the change plan API | 1237 |
| 7.4.10 | Constants used by the rerun API | 1238 |
| 7.4.11 | Constants used by the change delay monitor API | 1239 |
| 7.4.12 | Constants used by the change job status API | 1240 |
| 7.4.13 | Constants used for waiting | 1240 |
| 7.4.14 | Constants used for execution agent objects | 1241 |
| 7.4.15 | Constants used by the execution order control method change API | 1242 |
| 7.4.16 | Constant used by the unit information acquisition API | 1242 |

Appendixes 1244

| | | |
|-----|--|------|
| A | Notes on Defining Environment Variables and an Environment Variable File | 1245 |
| A.1 | Notes on defining environment variables | 1245 |
| A.2 | Notes on defining an environment variable file | 1246 |
| B | Notes on Using the Embedded-Database Commands | 1249 |
| B.1 | Adding a new administrator for the embedded database or changing an existing administrator | 1250 |
| B.2 | Changing the options of the tables in the embedded database | 1251 |
| B.3 | ajsembdbadduser | 1254 |
| B.4 | ajsembdbreuse | 1257 |
| C | Privileges Required for Operation as the AJS Administrator | 1262 |
| C.1 | Command execution privileges for operation as the AJS administrator | 1262 |
| C.2 | Access permissions for directories or files required for command operations by the AJS administrator | 1262 |
| D | Unit Information that Can Be Acquired by the API | 1265 |
| D.1 | List of members of the status monitoring resource that can be acquired by the API | 1265 |
| D.2 | List of members of the unit definition information object that can be acquired by the API | 1265 |
| D.3 | List of members of the status information object that can be acquired by the API | 1266 |
| D.4 | List of members of the release information object that can be acquired by the API | 1268 |
| E | Version Revisions | 1270 |
| F | Reference Material for This Manual | 1271 |
| G | Glossary | 1272 |

Index 1273

1

Overview of Commands

This chapter describes how to operate JP1/AJS3 using commands.

The same syntax and rules for JP1/AJS3 commands apply to both Windows and UNIX. (Note, however, that some of the commands and options that you can use differ between Windows and UNIX.)

Under Windows, execute commands from the command prompt. You can also use JP1/Script to create a script file for JP1/AJS3 commands. Using a script file created with JP1/Script, you can specify the time to start script processing or to automatically execute the script upon the activation of the system. For details about JP1/Script, see the manual *Job Management Partner 1/Script Description and Reference* (for Windows Systems).

Under UNIX, execute the commands from the control terminal.

1.1 Command syntax

This section describes the command syntax, including how to specify a command and the symbols used in the description of the command usage.

1.1.1 Specifying a command

Specify a command as follows:

| | | |
|--|---|------------|
| ajsxxx | | |
| $[\Delta_1\text{-option-A}[\Delta_0\text{value-a}[, \text{value-b}[, \text{value-c}\dots]]]] \dots(1)$ | } | $\dots(2)$ |
| $[\Delta_1\text{-option-B}[\Delta_0\text{value-a}[, \text{value-b}[, \text{value-c}\dots]]]] \dots(1)$ | | |
| $[\Delta_1\text{arbitrary-name-X}[\Delta_1\text{arbitrary-name-Y}[\Delta_1\text{arbitrary-name-Z}\dots]]]$ | | |
| Δ_0 : Specifies a blank consisting of 0 or more bytes. The blank can be omitted. | | |
| Δ_1 : Specifies a blank consisting of 1 or more bytes. The blank cannot be omitted. | | |

The parameters marked (1) are called *options*. All the parameters marked (2) are called *arguments*.

You can specify arguments as follows:

- Specify an option or options first, and then specify an arbitrary name or names, such as a unit name. If you specify an arbitrary name before an option, the system handles all specified arguments as arbitrary names.
- You can specify multiple options in any sequence. The same option, however, cannot appear more than once.
- You can specify multiple values for a single option by using commas to delimit them.
- You can collectively specify several options having no values.

Example:

You can specify `-abc` instead of `-a-b-c`.

- You cannot collectively specify several two-byte options having no values.

Example:

You cannot specify `-a-ab` as `-aab` or `-cd -cf` as `-cdcf`.

- You can specify a value for the last option of those collectively specified.

Example:

In `-abc xyz`, `xyz` specifies the value of `c`.

- If you specify a value for an option having no value, the system handles that option and all subsequent arguments as arbitrary names.
- Specifying an unexpected option results in an error.
- See [1.1.2 Specifying a unit name](#) for notes on specifying a unit name for an arbitrary name.
- See [1.1.4 Specifying wildcard characters](#) for notes on specifying wildcard characters for an arbitrary name.

- To specify the first arbitrary name (*arbitrary-name-X* in the above example) with a string starting with "-", enter `-- Δ_1 arbitrary-name-X`. (The system handles the string following `-- Δ_1` as an arbitrary name.) The specification of the second and subsequent arbitrary names does not require `-- Δ_1` .

Example:

To specify two arbitrary names (`-jobA` and `-jobB`) in series, enter `-- -jobA -jobB`.

- You can use regular expressions for an arbitrary name.
- Specifying a number of arbitrary names exceeding the expected maximum results in an error.
- Characters specified as arguments are case sensitive. Be careful about the case.

1.1.2 Specifying a unit name

The following describes how to specify a unit name as an arbitrary name for a command argument.

Specify a unit name as follows:

Command in which you can specify a logical host name (when remotely accessing an object on another host)

```
[ [logical-host-name: ] [scheduler-service-name ] : ] unit-name [ :@execution-ID ]
```

Command in which you cannot specify a logical host name (when locally accessing a unit on the local host)

```
[ [scheduler-service-name ] : ] unit-name [ :@execution-ID ]
```

The following explains the arguments:

logical-host-name

Some commands accept the specification of a logical host name while others do not. See the description of each command for details.

When the local host has more than one logical host name, specifying a scheduler service name and environment variable `JP1_HOSTNAME` determines the logical host name. You do not need to specify a logical host name. If you specify a logical host name, the system will attempt to establish communication by TCP/IP even within the local host, requiring the settings for authentication.

If you omit a logical host name, the specified scheduler service name will be prefixed with the value of environment variable `AJSMANAGERHOST`.

If `AJSMANAGERHOST` is not set, the system assumes that the service resides within the local host and uses the logical host name specified in environment variable `JP1_HOSTNAME`.

If `JP1_HOSTNAME` is not set, the system assumes the logical host name of the local host, specified in the JP1/Base configuration. With *logical-host-name* set to `JP1_HOSTNAME_DEFAULT`, the system host name (`gethostname`) is assumed.

Without the `JP1_HOSTNAME` environment variable, however, the system assumes the JP1/AJS3 service for the physical host.

scheduler-service-name

If you specify a scheduler service name, the `-F` option and environment variable `AJSCONF` are ignored.

If you do not specify a scheduler service name, the value set in the `-F` option is assumed. If the `-F` option is omitted, the value of the environment variable `AJSCONF` is assumed. If `AJSCONF` is not set, the system assumes the default *scheduler* service name.

unit-name

For a unit name, you can specify a job group name, jobnet name, or job name. You can also use a full name to specify the unit name.

A full name starts with `/`, followed by the names of the root job group to the unit, each delimited with `/`. The full name of a unit is uniquely managed in JP1/AJS3.

If you do not use a full name to specify a unit, the name will be prefixed with the value of environment variable `AJSPATH`. If `AJSPATH` is not set, the name will be prefixed with `/`.

You can use the following symbols to enable migration from the previous products (JP1/AJS):

```
" & ' * < > ? [ \ ] ^ ` { | } ~
```

If you include any of the above symbols in a unit name, enclose the entire unit name between double quotation marks ("), and place the backslash (\) character before each included symbol to cast the symbol. For example, if you use the `ajsprint` command and specify the unit `/net[1]`, specify `ajsprint "/net\[1\]"`.

These symbols are provided only for enabling migration from the previous products (JP1/AJS3), so do not use them for other purposes.

execution-ID

Some commands accept the specification of an execution ID while others do not. See the description of each command for details.

An execution ID is a number assigned to a scheduled execution for the top-level jobnet when registering the jobnet. You can use JP1/AJS3 - View and `ajsshow` command to check the execution ID. If you do not specify any execution ID for a command that accepts the specification of an execution ID, the command automatically determines the target generation. For details about automatic determination of jobnet generations, see *4.2 Managing jobnet generations* in the manual *JP1/Automatic Job Management System 3 Overview*.

1.1.3 Specifying a unit name in a command when using a planning group

If operating a unit under a planning group with the following commands, units, which have a generation at the command executions, are automatically selected as operands without the root jobnet name specified. Therefore, when the commands are executed, you can operate the running root job or its subordinate jobs even if the root jobnet name is not specified.

- `ajschgstat`
- `ajsintrpt`
- `ajskill`
- `ajsplan`
- `ajsrerun`
- `ajsshow`

Whether a unit is automatically selected as an operand depends on the value specified in `-X` option in the above commands or on the value of the environment variable set in `AJSAUTOJUDGE`. Other than the above commands, irrespective of the setting of the environment variable `AJSAUTOJUDGE`, the root jobnet name under a planning group cannot be omitted. The unit name should be specified in a full path which you want to operate.

For details of the commands above, see *1.5 Commands*. For detail of the environment `AJSAUTOJUDGE` see *1.4 Environment variables*.

The following rules apply whether the automatic selection setting is valid:

1. The values specified in the `-X` option of the command has the priority. If the `-X` option is specified, the decision takes place according to the specified value.

When `-X yes` is specified:

Automatic selection is effective. You can specify a unit name without the root jobnet under the planning group. The running units are selected automatically and execution takes place on the corresponding units.

When `-X no` is specified:

Automatic selection is not effective. You cannot omit the root jobnet name under the planning group. Specify the unit name in a full path.

When `-X auto` is specified:

Specify the root jobnet name in a full path under the planning group. In this case, the specified unit is an operand. The path name without specifying the root jobnet name under the planning group is shared by another unit is considered as omitted, the running units are automatically selected and the corresponding units are operated.

2. If the `-X` option is not specified, the value of the environment variable `AJSAUTOJUDGE` decides actions.

When `AJSAUTOJUDGE` is YES:

Automatic selection is effective. You can specify a unit name without the root jobnet under the planning group. The running units are selected automatically and execution takes place on the corresponding units.

When `AJSAUTOJUDGE` is NO:

Automatic selection is not effective. You cannot omit the root jobnet name under the planning group. Specify the unit name in a full path.

When `AJSAUTOJUDGE` is AUTO:

Specify the root jobnet name in a full path under the planning group. In this case, the specified unit is an operand. The path name without specifying the root jobnet name under the planning group is shared by another units is considered as omitted, the running units are automatically selected and the corresponding units are operated.

When value is not set:

Automatic selection is effective. You can specify a unit name without the root jobnet under the planning group. The running units are selected automatically and execution takes place on the corresponding units. If the unit name specified without a jobnet name cannot be found, the unit is considered as a full path name, and the corresponding unit is executed. If there is not corresponding unit, it is an error.

For a unit under the job group, the root jobnet name should be specified even if the value of the `-X` is specified or that of the environment variable `AJSAUTOJUDGE` is set.

For the environment variable `AJSAUTOJUDGE` used for remote command execution, the value set when `JP1/AJS3` is started is applied.

The following figure shows the unit configuration of a planning group when a command operates a unit under the planning group.

Figure 1–1: Unit configuration of planning group when a command executes

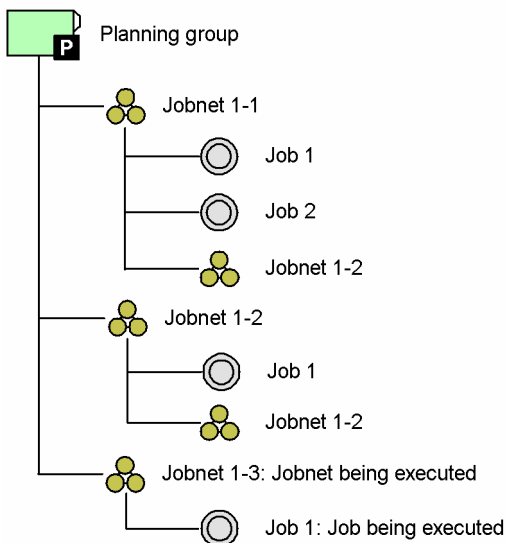

The following example of the `ajsplan` command shows, in the unit configuration shown in *Figure 1-1*, depending on the option specification and the setting of the environment variable, which unit is treated as an operand.

When `-X yes` is specified:

Command sequence: `ajsplan -h -X yes /Planning_group`

Operand unit: `planning_group/Jobnet1-3`

Command sequence: `ajsplan -h -X yes /Planning_group/Job1`

Operand unit: `planning_group/Jobnet1-3/Job1`

When `-X no` is specified:

Command sequence: `ajsplan -h -X no /Planning_group/Jobnet1-3/Job1`

Operand unit: `planning_group/jobnet1-3/Job1`

When `-X auto` is specified:

Command sequence: `ajsplan -h -X auto /Planning_group`

Operand unit: `Planning_group/Jobnet1-3`

Command sequence: `ajsplan -h -X auto /Planning_group/Jobnet1-1`

Operand unit: `Planning_group/Jobnet1-1`

Command sequence: `ajsplan -h -X auto /Planning_group/Job1`

Operand unit: `Planning_group/Jobnet1-3/Job1`

When `AJSAUTOJUDGE` is YES:

Command sequence: `ajsplan -h /Planning_group`

Operand unit: `Planning_group/Jobnet1-3`

Command sequence: `ajsplan -h /Planning_group/Job1`

Operand unit: `Planning_group/Jobnet1-3/Job1`

When `AJSAUTOJUDGE` is NO:

Command sequence: `ajsplan -h /Planning_group/jobnet1-3/Job1`

Operand unit: `Planning_group/jobnet1-3/Job1`

When `AJSAUTOJUDGE` is AUTO:

Command sequence: `ajsplan -h /Planning_group`

Operand unit: `Planning_group/jobnet1-3`

Command sequence: `ajsplan -h /Planning_group/Jobnet1-1`

Operand unit: `Planning_group/Jobnet1-1`

Command sequence: `ajsplan -h /Planning_group/Job1`

Operand unit: `Planning_group/jobnet1-3/Job1`

When no value is specified in `AJSAUTOJUDGE`:

Command sequence: `ajsplan -h /Planning_group`

Operand unit: `Planning_group/jobnet1-3`

Command sequence: `ajsplan -h /Planning_group/Jobnet1-1`

Operand unit: `Planning_group/Jobnet1-1`

Command sequence: `ajsplan -h /Planning_group/Job1`

Operand unit: `Planning_group/Jobnet1-3/Job1`

The root jobnet name under the planning group (`Planning_group/Jobnet1-2`) and the unit name under the root jobnet under the root jobnet (`Planning_group/Jobnet1-2/Jobnet1-2`) share the same unit name, the root jobnet name should be omitted when specifying the unit name. The running units are automatically selected and the corresponding units are operated.

If you want to operate the root jobnet under the planning group (`Planning_group/Jobnet1-2`), either specify `no` in the `-X` option or specify `NO` in the environment variable `AJSAUTOJUDGE`. with the unit name in a full path.

1.1.4 Specifying wildcard characters

Some arbitrary names can be specified with wildcard characters (such as `*`, `?`, `[` and `]`).

For example, when jobs (`job1`, `job2`, `job3`, `job4`) are defined in a jobnet (`/net1`), and you want to select all the jobs in the jobnet (`/net1`) as the operation target, you can specify `/net1/*`, `/net1/job?`, or `/net1/job[1234]`.

1.1.5 Specifying an IPv6 address

An IPv6 address can be specified as a command argument if it meets the following conditions:

- Only alphanumeric characters and colons (`:`) are used.
Note that alphabetic characters are case insensitive.
- The total size of the specified characters is within 3 to 39 bytes.

The following rules apply to the specification of IPv6 addresses:

- If a 16-bit character string (block) delimited by colons (`:`) begins with 0, the 0 can be omitted.
Example: The following IPv6 addresses are treated as the same address:
`2001:db80:1234:5678:9abc:def1:2345:0001`
`2001:db80:1234:5678:9abc:def1:2345:1`
- 16-bit character strings (blocks) whose bits are all 0 can be omitted. Consecutive blocks that contain only 0 can be omitted as a unit.
Example: The following IPv6 addresses are treated as the same address:
`2001:db80:0000:0000:0000:0000:0000:9abc`
`2001:db80::9abc`
- In JP1/AJS3, IPv6 addresses cannot be enclosed in square brackets (`[]`).
Example (allowed): `2001:db80::ffff:1`
Example (not allowed): `[2001:db80::ffff:1]`
- In JP1/AJS3, prefixes cannot be specified for IPv6 addresses.
Example (allowed): `2001:db80::ffff:1`
Example (not allowed): `2001:db80::ffff:1/32`

1.1.6 Symbols used in command usage description

The following table lists the symbols used in the description of command usage.

Table 1–1: Symbols used in command usage description

| Symbol | Meaning |
|------------------------------|--|
| | Only one of the options separated by a vertical bar can be used at one time. Example: A B C A, B, or C |
| { } | One of the items enclosed in braces and separated by a vertical bar must be specified. Example: {A B C} Specify A, B, or C. |
| [] | The item or items enclosed in brackets are optional. When multiple items are listed, choose one or omit all. Example: [A] Specify A or nothing. [B C] Specify B, C, or nothing. |
| . . . | The item or items preceding the ellipsis (. . .) can be repeated. Example: A, B, . . . After A, specify B as many times as necessary. |
| <u> </u> (underline) | The underlined characters are the system default when you omit all the items enclosed in brackets. If there is no default, only the specified item will take effect. Example: [<u>A</u> B] A is assumed if you do not specify either item. |

1.1.7 Remote execution of a command

You can execute a command remotely from a JP1/AJS3 - Manager host to another JP1/AJS3 - Manager host.

Using the remote command execution function, you can output information about the operation of units or the current operating environment for the scheduler service to the scheduler service on the target logical host.

The standard output, standard error output, and return values for the command executed remotely are reflected on the machine from which it is executed. Messages that may appear depend on the language type selected when the JP1/AJS3 is started on the target host.

The following table shows the commands you can execute remotely and how to execute them.

Table 1–2: Commands you can execute remotely and how to execute them

| Command name | Method of remote execution | | |
|--------------|--|---|--|
| | Add a logical host name to a job, jobnet or job group name | Specify a logical host name with the <code>AJSMANAGERHOST</code> environment variable#1 | Specify a logical host name with an option |
| ajschange | Yes | Yes | No |

| Command name | Method of remote execution | | |
|-------------------------|--|---|--|
| | Add a logical host name to a job, jobnet or job group name | Specify a logical host name with the <code>AJSMANAGERHOST</code> environment variable ^{#1} | Specify a logical host name with an option |
| <code>ajschgjob</code> | Yes | Yes | No |
| <code>ajschgnet</code> | Yes | Yes | No |
| <code>ajsentry</code> | Yes | Yes | No |
| <code>ajsintrpt</code> | Yes | Yes | No |
| <code>ajskill</code> | Yes | Yes | No |
| <code>ajsleave</code> | Yes | Yes | No |
| <code>ajspan</code> | Yes | Yes | No |
| <code>ajspanout</code> | Yes | Yes | No |
| <code>ajsprint</code> | Yes | Yes | No |
| <code>ajsrerun</code> | Yes | Yes | No |
| <code>ajsshow</code> | Yes | Yes | No |
| <code>ajsstatus</code> | No | Yes | Yes ^{#2} |
| <code>ajssuspend</code> | Yes | Yes | No |

Legend:

Yes: Can be used.

No: Cannot be used.

Note

See *Table 1-5 in 1.4.1 Environment variables used to execute JP1/AJS3 commands* for the list of environment variables used during command execution.

#1

Do not set the `AJSMANAGERHOST` environment variable when starting JP1/AJS3.

#2

Use the `-h` option.

To execute a command remotely, start the JP1/AJS3 on the command target host. You must also use the JP1/Base user management function to set user authentication, user mapping, and other necessary information.

For details on how to set the user management function of JP1/Base in a Windows host, see *3. Setup* in the *JP1/Automatic Job Management System 3 Configuration Guide*. For details on how to set the user management function of JP1/Base in a UNIX host, see *13. Setup* in the *JP1/Automatic Job Management System 3 Configuration Guide*.

1.1.8 Environment variables for command execution

When executing a command for the JP1/AJS3 service on the logical host, you must assign a logical host name to the `JP1_HOSTNAME` environment variable.

With commands for operating jobnets and jobs, the privilege to access units is identified according to the OS user name for command execution. If the OS user name is different from the JP1 user name, assign the JP1 user name to the JP1_USERNAME environment variable.

See *Table 1-5* in *1.4.1 Environment variables used to execute JP1/AJS3 commands* for the list of environment variables used during command execution.

1.2 Notes on using commands

The following are notes on executing commands.

1.2.1 Notes common to all commands

- If a command is executed with character encoding different from the character encoding used by the JP1/AJS3 service, a message is output to the integrated trace log with character encoding of the command. As a result, messages might be output in several types of character encoding characters, causing the message text to be garbled.
- If the character encoding used by the system is EUC and the character string displayed in the command execution result contains Japanese characters, the displayed execution result might be misaligned.
- In JP1/AJS3 - Manager on a UNIX host, the user must have reference privilege for the `/opt/jp1/hcclibcnf/regdir/HKEY_LOCAL_MACHINE.dat` file to execute a command. If you execute a command without reference permission for this file, the following error message is output: `KAVS1007-E Host name cannot be resolved (logical-host-name)`.
- When specifying a file name as a command argument, make sure that the content of the file conforms to the character encoding specified in the `AJSCHARCODE` environment setting parameter.

1.2.2 Notes on commands related to the scheduler service

When execution registration of a jobnet (including an operation from JP1/AJS3 - View) is canceled, processing to update the database is required. Because the amount of the update processing depends on the number of saved generations, the processing might take a long time. To prevent the update processing from affecting other processing, note the following:

- Do not execute multiple commands that cancel execution registration simultaneously.
- Execute commands that cancel execution registration in non-busy hours.
- Specify the environment variables that must be set during command execution.
For details about the environment variables that must be set, see [1.1.8 Environment variables for command execution](#).

1.2.3 Notes on commands that consume a large amount of system resources or commands that perform mutually conflicting processes

When using commands involving high cost (including operations from JP1/AJS3 - View and JP1/AJS3 - Web Console), such as those consuming a large amount of system resources or those conflicting with each other, you should execute them as follows:

Operation related to the execution of jobs or jobnets

Continuously executing commands related to the execution of jobs or jobnets may increase the workload for the service, badly affecting operation. You should execute commands related to the execution of jobs or jobnets at intervals of two or three seconds.

Examples of applicable commands: `ajsleave`, `ajsrerun`, `ajsplan`, and `ajsintrpt`

Operation affected by the number of subordinate units

For some commands, the amount of target information increases in proportion to the number of subordinate units, badly affecting operation. If the number of subordinate units exceeds 500, you should execute a command in non-busy hours.

Examples of applicable commands: `ajsleave`, `ajsrerun`, and `ajsplan`

Operation for a large number of units with wildcard characters or the `-R` option specified

If you execute a command with wildcard characters or the `-R` option specified, it may process a large amount of information, badly affecting operation. If you specify wildcard characters or the `-R` option, also use the `-E`, `-L`, or `-T` option to narrow the range of units to be processed. In JP1/AJS3 - View, you should select a few units at the same time.

This does not apply to JP1/AJS3 - Web Console because you cannot select and operate multiple units.

Examples of applicable commands: `ajsleave`, `ajsrerun`, `ajsplan`, and `ajsintrpt`

Operation for jobnets having a large number of generations

If you execute a command for a jobnet having a large number of generations, it may process a large amount of information, badly affecting operation. You should execute a command for a jobnet having a large number of generations in non-busy hours. You should also use options to narrow the target period and the range of generations to be processed.

Examples of applicable commands: `ajsleave`, `ajsrerun`, `ajsplan`, and `ajsintrpt`

For a list of applicable operations, see *1.3.2 Operations that might affect JP1/AJS3 system operation* in the *JP1/Automatic Job Management System 3 System Design (Configuration) Guide*.

1.2.4 Notes on operation in the console for executing commands

The operating system has a feature for temporarily stopping a process running in the console. Using this feature may prevent resources allocated by the stopped process from being released, depending on the timing. In that case, other processes may be kept waiting, the remote process may time out, or the command may sleep without finishing. While executing a command, avoid the following operation:

- In Windows:
 - If the simple edit mode is enabled for the command prompt, clicking the command prompt window causes the title bar to display **Select** and the window output to stop. In that case, the execution of the command stops until canceled. You should not, therefore, use the simple edit mode.
 - Do not press **Ctrl + S** to stop the output during the execution of a command. The execution of the command stops until canceled.
- In UNIX:

Do not use the SIGTSTP signal to temporarily stop the process during the execution of a command. This signal is assigned to **Ctrl + Z**, by default. If you use the signal to stop the command with resources not released, the JP1/AJS3 service or other commands may not be able to obtain necessary resources and be placed in the wait state.

1.2.5 Cautionary notes when UTF-8 is used as the character encoding

- When the character encoding is UTF-8, multi-byte characters such as Japanese require more bytes than when other character encodings are used. Therefore output columns will be misaligned if output information includes Japanese when the following commands are executed:

Applicable commands:

```
ajsshow, ajsrelease, jpqagtshow, jpqqueshow, jpqresshow, jpqendjobshow,  
jppqjobshow, jpqdbcond, jpqreguser, ajsagtshow, ajsplanout
```

- When the character encoding is UTF-8, and multi-byte characters such as Japanese are specified for command execution, the number of available character codes might be fewer than if another character encoding were used.
- When the following commands are remotely executed from a host that uses UTF-8 encoding, and the execution host DB type (AJSCHARCODE) is also UTF-8, the AJS_CONVERT_UTF8 environment variable must be set to no.

Applicable commands:

```
ajschange, ajschgjob, ajschgnet, ajsentry, ajsintrpt, ajskill, ajsleave, ajsplan,  
ajsprint, ajsrerun, ajsshow, ajsstatus, ajssuspend, ajsplanout
```

If you remotely execute these commands when the AJS_CONVERT_UTF8 environment variable is undefined or set to yes, the execution results might be unreadable or the processing executed for the units might not be correct.

For details about the AJS_CONVERT_UTF8 environment variable, see [Table 1-5](#) in [1.4.1 Environment variables used to execute JP1/AJS3 commands](#).

- When UTF-8 encoding is used, and the DEFLENTYPE environment setting parameter is set to sjis, the number of characters that can be specified for the following items is the same as in the Shift-JIS environment:
 - Unit name in the unit detailed information definition
 - Comment in the unit detailed information definition
 - Exclusive jobnet in the Schedule Settings

Note that the maximum number of nested units (maximum number of hierarchical levels) becomes 10 (the default is 30).

1.2.6 Note on using commands in Windows

Using commands in Windows, note the following:

- Do not use the 3rd level and 4th level Kanji characters added in JIS 2004 in command arguments. If these characters are used, operation might not be performed correctly.
- Before you execute a command that must be executed by a user with administrator privileges, make sure that you open the Command Prompt window as an administrator. Note, however, that if UAC is disabled, you do not have to start the Command Prompt window as an administrator.

1.2.7 Note on using commands in Solaris 11

When you execute a command whose name begins with jpq, jajjs_spmd, ajsagtadd, ajsagtalt, or ajsagt del in Solaris 11, you must set the JP1_HCCNETSOCK environment variable by using the example settings described below as a reference.

```
# JP1_HCCNETSOCK=JP1_AJS  
# export JP1_HCCNETSOCK
```

However, the following commands are excluded.

- jpqimport

- `jpgqexport`
- `jpgqregguestuser`
- `jpgqreguser`
- `jpgqdbcond`

1.2.8 Note on using commands in HP-UX, AIX, or Linux

If you use JP1/AJS3 on HP-UX, AIX, or Linux, you cannot use the following commands:

- `ajscnvdbexport`
- `ajscnvdbimport`
- `jplajs2_setup_cluster`

1.3 Linkage with other programs

You can use commands to submit jobs to the JP1/OJE for VOS3 host, or the AS/400 (JP1/OJE for Midrange Computer) host and monitor the job execution status.

You can link with other programs by specifying commands in the same way as normal operation without linkage; however, there are some limit values for specifying items such as job names and user names. This section provides details of the limit values and notes on each linkage program.

1.3.1 Linkage with JP1/OJE for VOS3

Limit values

For a JP1/OJE for VOS3 system, you can use the following commands:

`jpgendjobshow`, `jpgjobcan`, `jpgjobget`, `jpgjobshow`, `jpgjobsub`, `jpgqueshow` and `ajsdefine` (QUEUE job definition information in a unit definition file)

The following table shows the limit values for the above commands.

Table 1–3: Limit values when linking with JP1/OJE for VOS3

| Defined item | Limit values |
|--------------------------------|--|
| Manager host name | JP1/OJE for VOS3 host name: Character string of up to 255 bytes. |
| Queue name | Character string of up to 32 bytes. Japanese characters cannot be specified. Case-sensitive. |
| Job name | Character string of up to 63 bytes. Japanese characters cannot be specified. By default, the system assumes the job name specified in the JOB statement in JCL. |
| User name | Character string of up to 32 bytes. Japanese characters cannot be specified. |
| Execution priority | Cannot be specified. (If you specify an execution priority, JP1/OJE for VOS3 ignores it. In JP1/OJE for VOS3, jobs are executed according to the execution priority sequence specified with JCL.) |
| Execution file name | This is a mandatory item. Character string of up to 54 bytes. Specify the name of the dataset containing the job and the member name if a segmented or LIME dataset is used. Japanese characters cannot be specified. |
| Parameter | Character string of up to 1,023 bytes. If you specify an argument to be passed to the program being executed, it is ignored. However, it is possible to specify a character string intended to replace part of JCL (for how to specify it, see the manual <i>Job Management Partner 1/Open Job Entry Description, User's Guide and Reference</i> (for VOS3 systems)). If the character string excluding the part used for replacement exceeds 100 bytes, a parameter error occurs. |
| Transfer destination file name | Character string of up to 54 bytes. Specify the name of a dataset to which you will transfer a file. Japanese characters cannot be specified in the dataset name and in the file. |

Cautionary note

Before starting linkage with JP1/OJE for VOS3, you must use the `jpgreguser` command to register user information (for the VOS3 user corresponding to the login user for command execution) in the host from which you will submit the job.

For details on the `jpgreguser` command, see *jpgreguser* in 2. *Commands Used during Setup*.

1.3.2 Linkage with AS/400 (JP1/OJE for Midrange Computer)

Limit values

You can use the following commands for the AS/400 system:

`jpgendjobshow`, `jpgjobcan`, `jpgjobget`, `jpgjobshow`, `jpgjobsub`, `jpgqueshow` and `ajsdefine` (QUEUE job definition information in a unit definition file).

The following table lists the limit values for the commands.

Table 1–4: Limit values when linking with AS/400 (JP1/OJE for Midrange Computer)

| Defined Item | Limit values |
|--------------------------------|--|
| Manager host name | Host name for the AS/400 system: Character string of up to 15 bytes. |
| Queue name | Job queue name for the AS/400 system: Character string of up to 10 bytes. |
| Job name | Job name for the AS/400 system: Character string of up to 10 bytes. The default is NONAME. |
| User name | Character string of up to 32 bytes. Japanese characters cannot be specified. |
| Execution priority | Specify the execution priority for the job on the AS/400 system. You can set 1, 3, or 5. The highest priority is 5. By default, the system assumes 1. If you specify 2 or 4, the system assumes 1 or 5, respectively. |
| Execution file name | Specify the name of the executable file on the AS/400 system in <i>library-name/file-name</i> or <i>library-name/file-name.member-name</i> format. For each part of the name, you can specify a character string of up to 10 bytes. |
| Parameter | Specify a parameter string of up to 32 bytes that you want to pass to the executable file on the AS/400 system. You can specify more than one parameter by delimiting them with a comma. |
| Transfer source file name | Specify a file in JP1/AJS3 - Manager. Use a character string of up to 511 bytes. Specify a full-path file name. Only plain-text files can be transferred. Each line cannot exceed 80 characters. |
| Transfer destination file name | Specify the destination on the AS/400 system in <i>library-name/file-name.member-name</i> format. You must specify a file which already exists on the AS/400 system. If you specify the file in <i>file-name.member-name</i> format without a library name, the system assumes the library name specified with DFT_PTH in the configuration definition file for the AS/400 system. |

For further details, see the *Job Management Partner 1/Open Job Entry for Midrange Computer Description and User's Guide*.

1.4 Environment variables

This section shows the environment variables used to execute JP1/AJS3 commands as well as those set when a job is executed from JP1/AJS3.

1.4.1 Environment variables used to execute JP1/AJS3 commands

The following table lists the environment variables used for command execution.

Table 1–5: Environment variables used for command execution

| Environment variable | Description | Referenced |
|----------------------|---|--|
| AJSMANAGERHOST | Logical host name of target host | When a logical host name is omitted in the specification of a unit name for remote execution of a command that operates units or the <code>ajsstatus</code> command ^{#1} |
| JP1_HOSTNAME | Logical host name of local host | When JP1/AJS3 references the logical host name of the local host or when it references the logical host of the target of operation for command execution (assuming that no logical host name has been specified as a command option) ^{#2} |
| AJSCONF | Scheduler service name | When a scheduler service name is omitted in the object name specification and it is also omitted in the <code>-F</code> option |
| AJSPATH | AJS path name | When a unit name is not specified as a full name (used as a job group name) in any command ^{#1} used to manipulate units |
| JP1_USERNAME | JP1 user name | When a JP1 user name different from the OS user name is used to acquire user access permissions by using a command used to manipulate a unit ^{#1} or a command used to operate execution agents |
| LANG | Language type | When the language type of the text to be output is identified. In Windows, this environment variable is not available because the language type depends on the host settings. If commands used to manipulate a unit ^{#1} are executed, make sure that the value of this environment variable is the same as the value of the <code>AJSCHARCODE</code> environment variable of the scheduler service in which the unit to be manipulated by the commands is defined. If you use Chinese, however, specify the GB18030 code supported by JP1/AJS3 for <code>LANG</code> . |
| TZ | Time zone | When calculating a schedule or displaying a date and time ^{#3} |
| AJSAUTOJUDGE | Specifies the function for automatically selecting a target unit from the list of units in a planning group | When the <code>-X</code> option is omitted in any of the following commands: ^{#4} <ul style="list-style-type: none"> • <code>ajschgstat</code> command • <code>ajsintrpt</code> command • <code>ajskill</code> command • <code>ajsplan</code> command • <code>ajsrerun</code> command • <code>ajsshow</code> command |
| AJSDISPSUBUNITTYPE | Displays or hides the job group type | When the <code>ajsrestore</code> command is used to output a list of the units backed up in the backup box to the standard output file ^{#5} |

| Environment variable | Description | Referenced |
|----------------------|--------------------------|--|
| AJSCONVERTUTF8 | Converts character codes | When a command is remotely executed, because the value of environment variable LANG on the execution host is either ja_JP.UTF-8, ja_JP.utf8, JA_JP, or JA_JP.UTF-8, JP1/AJS3 - Manager communication processing does not perform character code conversion. ^{#6} |
| LC_ALL | Language type | When a multi-byte character is specified for an argument of a command or for the unit name to be processed. In Windows, this environment variable is not used because the language type depends on the host settings. You do not have to set this environment variable. If you need to set this variable, set the same value as the environment variable LANG. If you set a different value, JP1/AJS3 processing that uses a multi-byte character might malfunction. |

#1

See [Table 1-10](#) for the commands used to manipulate units. Also, do not set the AJSMANAGERHOST environment variable when starting JP1/AJS3.

#2

The user mapping to be used varies with whether or not the JP1_HOSTNAME environment variable is set.

If the JP1_HOSTNAME environment variable is set, the user mapping defined in the logical host specified with the JP1_HOSTNAME environment variable is used.

Otherwise, the user mapping defined in the physical host is used.

You must set the JP1_HOSTNAME environment variable if you reference a logical host.

Do not set JP1_HOSTNAME when referencing a physical host. Setting JP1_HOSTNAME may cause the command to fail.

#3

In Windows, make sure that the time zone used for command execution is the same as the system time zone.

#4

According to the value specified in the AJSAUTOJUDGE environment variable, select a target unit from the units listed in a planning group.

You can specify the following values for the AJSAUTOJUDGE environment variable:

YES

Specify this to automatically select a target unit.

When specifying a unit name in the command, omit a root jobnet name in a planning group.

NO

Specify this if you do not want to automatically select a target unit.

You must specify a unit for which the command will operate. You cannot omit a root jobnet name in a planning group.

AUTO or no specification

Whether a target unit will automatically be selected depends on how the unit name is specified.

- If you want to automatically select a target unit:
Specify a unit name without a root jobnet name in a planning group.
- If you do not want to automatically select a target unit:
Specify a unit name with a root jobnet name in a planning group. The command will operate for the specified unit only. However, if there is a unit having the same name as the path name specified without a root

jobnet name in a planning group, a root jobnet name is assumed to be omitted so that a target unit will be selected automatically.

#5

According to the `AJSDISPSUBUNITTYPE` environment variable, determine the format of output to the standard output file.

You can specify the following values for the `AJSDISPSUBUNITTYPE` environment variable:

YES

Output the job group type.

Output format:

save-file-name : save-source-unit-name : saved-unit-name : saved-unit-type (job-group-type)

Example:

0001:/group1:group2:g(p)

NO or no specification

Do not output the job group type.

Output format:

save-file-name : save-source-unit-name : saved-unit-name : saved-unit-type

Example:

0001:/group1:p_group1:g

For an explanation of the unit type and job group type, see [Table 3-13](#) in the description of *ajsprint* in [3. Commands Used for Normal Operations](#).

#6

When the `LANG` environment variable on the remote execution host is set to either `ja_JP.UTF-8`, `ja_JP.utf8`, `JA_JP`, or `JA_JP.UTF-8`, the value specified for the `AJS_CONVERT_UTF8` environment variable defines whether the communication processing by JP1/AJS3 - Manager converts character codes.

The following lists the values that can be specified for the `AJS_CONVERT_UTF8` environment variable.

yes or undefined

JP1/AJS3 - Manager converts character codes during communication processing.

no

JP1/AJS3 - Manager does not convert character codes during communication processing.

If both the source and destination hosts for remote command execution use UTF-8, set this parameter to `no`.

1.4.2 Environment variables set when a job is executed from JP1/AJS3

The following table shows the environment variables that are set when a job is executed.

Table 1–6: Environment variables set for job execution

| Environment variable | Description |
|------------------------|--|
| <code>AJSENV</code> | Allows you to identify that the job has been started as scheduled. Usually, this variable is set to <code>YES</code> . |
| <code>AJSPRE_ST</code> | Sets the character indicating the end status of the preceding job or jobnet. One of the following characters is specified: n: Normal end |

| Environment variable | Description |
|------------------------------------|--|
| AJSPRE_ST | w: Ended with warning a: Abnormal end If there are two or more preceding jobs or jobnets, the highest level of seriousness is set. If there is no preceding job or jobnet, n (normal end) is set. For a starting job for re-execution, the status of the preceding job or jobnet of the starting job is set. If the re-execution changes the status of the preceding job or jobnet to normal end or end with warning, the changed value is set. |
| AJSPRE_RC | Sets the return value for the preceding job (-2,147,483,648 to 2,147,483,647). If there are two or more preceding jobs, the logical OR of all return values is set. If there is no preceding job, 0 is set. For a starting job for re-execution, the return value for the previous execution is set. |
| AJSNETNAME#1 | Sets the root jobnet name (character string of up to 899 bytes). |
| AJSJOBNAME#1 | Sets the job name (character string of up to 930 bytes). |
| AJSHOST#1 | Sets the name of the manager host (character string of up to 255 bytes) which has requested the execution of the job. |
| AJS_AJSCONF#1 | Sets the scheduler service name of the manager host (character string of up to 30 bytes) which has requested the execution of the job. |
| AJSEXDATE#1 | Sets the scheduled date of starting root jobnet execution (in the <i>yyyy/mm/dd</i> format). If the execution of the jobnet is delayed or the job is re-executed on the next day, the original scheduled date is set. |
| AJSEXECID#1 | Sets the job execution ID (character string of up to 10 bytes). |
| AJSEXECPID#1 | Sets the execution ID of the generation for which a start condition is monitored (character string of up to 10 bytes). No value is set if a start condition is not monitored. |
| JP1_HOSTNAME#1 | Sets a logical host name for only a logical host.#2 |
| JP1JobName#1 | Sets the execution file name or job name (character string of up to 63 bytes). If a job name has been specified in a QUEUE job or <code>jpqjobs sub</code> command, that job name is set. If a job name has not been specified for a PC job, Unix job, QUEUE job, or action job, the execution file name is set. For the execution file name, the system assumes the first 63 bytes of the file name (excluding the path). |
| JP1JobID#1 | Sets the job number (1 to 999,999). For a queueless job, this variable sets the ID (character string of up to 10 bytes) that is used internally. |
| JP1UserName#1 | Sets the name of the user who has submitted the job (character string of up to 63 bytes). |
| JP1_USERNAME#1 | Sets the name of the user who has submitted the job (character string of up to 63 bytes). |
| JP1UNCName#1 | Sets the name of the agent host that is running the job (character string of up to 255 bytes). |
| JP1NBQSQueueName#1 | Sets the name of the manager host with which the job is registered (character string of up to 255 bytes) and the queue name (character string of up to 63 bytes) in <code>\\manager-host-name\queue-name</code> format. If an execution agent name (character string of up to 255 bytes) is specified for the execution agent in the detailed definition of the job, the execution agent name is set in place of the queue name in <code>\\manager-host-name\execution-agent-name</code> format. If an execution agent group name (character string of up to 255 bytes) is specified for the execution agent in the detailed definition of the job, the execution agent group name is set in place of the queue name in <code>\\manager-host-name\execution-agent-group-name</code> format. For a queueless job, this variable does not set anything. |
| JP1NBQSCliantName (Windows only)#1 | Sets the name of the client computer which has entered the job (character string of up to 15 bytes). For a queueless job, this variable does not set anything. |

| Environment variable | Description |
|---|--|
| JP1Priority ^{#1} | Sets the execution priority for the job (1 to 5 for the UNIX version and 32, 64, or 128 for the Windows version; 64 = low, 32 = middle, 128 = high). |
| HOME (UNIX only) | Sets the login directory defined in the password file of the job-specified execution user. If no execution user is specified, the OS user corresponding to the JP1 user having registered the jobnet is set as the execution user. |
| SHELL (UNIX only) | <p>Sets the execution shell required to execute jobs. Execution shells are determined according to the following levels of priority. Note that the shell to set changes depending on how the job is registered.</p> <p>In the following cases, the first listed shell has the highest priority level:</p> <p>When Command statement is not specified for a job that will be executed in a jobnet</p> <ol style="list-style-type: none"> 1. The shell specified on the first line of the script file specified for the job 2. The login shell defined in the password file of the user who executes the job 3. /bin/sh <p>When Command statement is specified for a job that will be executed in a jobnet^{#3}</p> <ol style="list-style-type: none"> 1. The shell specified on the first line of Command statement specified for the job 2. The login shell defined in the password file of the user who executes the job 3. /bin/sh <p>When the <code>jpqjbsub</code> command is used to execute the job</p> <ol style="list-style-type: none"> 1. The shell specified on the first line of the script file specified for the job 2. The shell path name specified in the <code>jpqjbsub</code> command's <code>-shl</code> option 3. The login shell defined in the execution user's password file 4. /bin/sh |
| LANG (UNIX only) | Sets the LANG environment variable for use at the JP1/AJS3 startup. ^{#5, #6} JP1/AJS3 for Windows usually does not read user environment variables. When a cluster system is set up, however, user environment variables are read according to the Failover Clustering specifications. |
| LONGNAME (UNIX only) | Sets the name of the execution user specified in the job. If no execution user is specified, the OS user corresponding to the JP1 user having registered the jobnet is set as the execution user. |
| MAIL (UNIX only) ^{#1} | Sets <code>/usr/mail/execution-user-name</code> , where <i>execution-user-name</i> refers to the job-specified execution user or the OS user corresponding to the JP1 user having registered the jobnet. |
| PATH (UNIX only) ^{#1} | Sets <code>/bin:/usr/bin</code> . ^{#4, #5} |
| AJSQlManagerName (Windows only) ^{#1} | For queueless jobs only, sets the name of the manager host (character string of up to 255 bytes) which has requested the execution of the job. |

Notes

- The environment variables listed in [Table 1-6](#) cannot be used as environment variables for job definition. They cannot be used within any file specified as an environment file either.
- For AIX, the information for `/etc/environment` is not inherited.
- Do not use any environment variable starting with JP1, AJS, or AJS2 (case-insensitive). For a flexible job, do not use any environment variables that begin with JP1, AJS, AJS2, or AS_ (case-insensitive).
- The TZ environment variable is not set during job execution.
- Environment variables beginning with AJS are set only when a job is registered from a jobnet. They are not set in a submit job.

#1

This environment variable is not set for a flexible job.

#2

In UNIX:

- When you specify JP1/AJS3 as the execution target service in the detailed definition of a job
The logical host name specified in the `-h` option of the `jajs_spmd` command is set.
If you omit the `-h` option, and the value of the `JP1_HOSTNAME` environment variable has been set, that value is passed as the logical host. Nothing is set for a physical host.
- When you specify JP1/AJS3 Queueless Agent as the execution target service in the detailed definition of a job
If the host that executes the job is a logical host, the value specified as the execution agent in the detailed definition of the job is set. Nothing is set when the host that executes the job is a physical host.

In Windows:

- When you specify JP1/AJS3 as the execution target service in the detailed definition of a job
For a logical host, the logical host name is set in the `JP1_HOSTNAME` environment variable at the startup of the JP1/AJS3 service. Nothing is set for a physical host.
- When you specify JP1/AJS3 Queueless Agent as the execution target service in the detailed definition of a job
If the host that executes the job is a logical host, the value specified as the execution agent in the detailed definition of the job is set. Nothing is set when the host that executes the job is a physical host.

#3

If a shell is specified on the first line of the script file specified in **Script file name** when a command statement is also specified in **Command statement**, the specification of the shell has no effect.

#4

When a job is started from JP1/AJS3, JP1/AJS3 will explicitly set the `/bin:/usr/bin` value in the `PATH` environment variable. If you want to set any other value, you must set the value in a definition of the command or script file specified when the job was defined, or a definition in the local login script.

#5

If the service to be executed is for **Queueless Agent** jobs, the environment variable value set when the queueless agent service starts will be set.

#6

For a flexible job, the environment variable value set when the JP1/AJS3 Autonomous Agent service was started will be set.

Usually, environment variables are set in JP1/AJS3. Those variables include those listed in *Table 1-6*, as well as those specified for job definition, and those contained in files specified as environment files for job definition. In addition, environment variables may also be set in the command statements, script files, local login scripts, and system login scripts specified for job definition.

For environment variables like `TZ` that are not set during job execution, set them as one of the options below. If the same environment variables are found in these, they will be valid according to the following levels of priority (with the value of 1 as the highest level).

- In Windows:
 1. Environment variables specified for **Environment variables**^{#1}
 2. Environment variables specified for **Environment file**^{#2}
 3. System environment variables
- In UNIX:
 1. Definitions in the commands or script files specified for job definition

2. Definitions contained in local login scripts
3. Definitions contained in system login scripts
4. Environment variables specified for **Environment variables**^{#1}
5. Environment variables specified for **Environment file**^{#2}
6. Environment variables set when the queueless agent service starts^{#3}

#1

Variables specified for **Environment variables** in the JP1/AJS3 - View window or those specified with the `-env` option for the `jpqjobsub` command.

#2

Variable files specified for **Environment file** in the JP1/AJS3 - View window or those specified with the `-ev` option for the `jpqjobsub` command.

#3

Applicable only when the service to be executed is for **Queueless Agent** jobs.

Cautionary note

In Windows, when a job is executed, system environment variables are enabled, but user environment variables are not. However, if the JP1/AJS3 service start account is changed from a system account to a user account, when a job is executed, the user environment variables for the JP1/AJS3 service start account are enabled.

In addition, when the system is configured as a cluster system with logical hosts, the Failover Clustering[#] reads the user environment variables at system startup. The user environment variables take effect in the JP1/AJS3 services started by the Failover Clustering on the logical hosts, and are also used at job execution.

In addition to the system environment variables, the environment variables set at OS startup are also read when JP1/AJS3 services are activated.

#

For clustering software other than Failover Clustering, see the software specifications.

1.5 Commands

This section classifies all commands into the following groups according to the purpose of the command:

- Commands used to set up JP1/AJS3
- Commands used to customize environments
- Commands used to control JP1/AJS3
- Commands used to manipulate units
- Commands used to operate execution agents
- Commands used to execute jobs
- Commands used to manipulate embedded databases
- Commands used when an error occurs
- Commands used during special operation

The subsequent sections detail the commands in the alphabetical order of their names. Note that some of the commands are applicable to UNIX only and that others are applicable to Windows.

1.5.1 Commands used to set up JP1/AJS3

The following table lists the commands used to set up JP1/AJS3:

For details about the setup commands, see [2. Commands Used during Setup](#).

Table 1–7: Commands used to set up JP1/AJS3

| Function | Command name | Windows | UNIX | Required privileges | Supported products |
|--|--------------------------------|---------|------|---|--------------------|
| Sets up a database to be used by scheduler services. Sets up suspend functions. | <code>ajssetup</code> | Y | Y | Windows: Administrators UNIX: Superuser | M |
| Sets the mail distribution functions. | <code>jpomailrecv</code> | -- | Y | None | M and A |
| Registers the VOS3 user information. | <code>jpqreguser#1</code> | Y | Y | None (In Window, Administrators except when the <code>-a</code> option is specified) | M and A |
| Registers information about a user assumed to be a JP1 user. | <code>jpqregguestuser#1</code> | Y | Y | Windows: Administrators UNIX: Superuser | M |
| Creates or deletes an adapter command setting file used to link JP1/IM. | <code>ajs_adapter_setup</code> | Y | Y | Windows: Administrators UNIX: Superuser | M |
| Sets up an embedded database environment. | <code>ajsembdbsetup</code> | Y | Y | Windows: Administrators UNIX: Superuser | M |
| Builds an embedded database environment. | <code>ajsembdbbuild</code> | Y | Y | Windows: Administrators UNIX: Superuser | M |

| Function | Command name | Windows | UNIX | Required privileges | Supported products |
|---|---------------------------------|---------|------|--|-----------------------|
| Removes setup of an embedded database. | <code>ajsembdbunset</code> | Y | Y | Windows: Administrators UNIX: Superuser | M |
| Displays the information necessary for a command that is used to manipulate the embedded database and that is registered in the configuration definition. | <code>ajsembdbidlist</code> | Y | Y | Windows: Administrators UNIX: Superuser | M |
| Sets up the execution environment for the definition pre-check function. | <code>ajschksetup</code> | Y | Y | Windows: Administrators UNIX: Superuser | M and A |
| Defines JP1/AJS3 environment setting parameters. | <code>jajs_config</code> | Y | Y | Windows: Administrators UNIX: Superuser | M and A |
| Sets up JP1/AJS3. | <code>jajs_setup</code> | Y | Y | Windows: Administrators UNIX: Superuser | M |
| Sets up the operating environment corresponding to the JP1/AJS3 logical host. | <code>jajs_setup_cluster</code> | Y | Y | Windows: Administrators UNIX: Superuser | M and A |
| After JP1/AJS2 is upgraded to JP1/AJS3, sets up JP1/AJS3 so that it is in the standard configuration. | <code>jajs_migrate</code> | Y | Y | Windows: Administrators UNIX: Superuser | M |
| Exports the scheduler service data to a binary file from the database in an environment of JP1/AJS2 Version 8 or earlier. | <code>ajscnvdbexport</code> | Y | S | Windows: Administrators UNIX: Superuser | M |
| Imports database backup data to a scheduler database. | <code>ajscnvdbimport</code> | Y | S | Windows: Administrators UNIX: Superuser | M |
| Installs the JP1/AJS3 standard database (embedded database). | <code>ajsembdbinstl</code> | Y | Y | Windows: Administrators UNIX: Superuser | M |
| Uninstalls the JP1/AJS3 standard database (embedded database). | <code>ajsembdbuninstl</code> | Y | Y | Windows: Administrators UNIX: Superuser | M |
| Exports the disaster recovery operation setup information. | <code>jajs_rpenvexport</code> | Y | Y | Windows: Administrators UNIX: Superuser | M |
| Imports the disaster recovery operation setup information. | <code>jajs_rpenvimport</code> | Y | Y | Windows: Administrators UNIX: Superuser | M |
| Sets up the disaster recovery environment. | <code>jajs_rpsite</code> | Y | Y | Windows: Administrators UNIX: Superuser | M |
| Sets up the JP1/AJS3 Autonomous Agent service and the JP1/AJS3 Autonomous Agent Messenger service. | <code>ajsatsetup</code> | Y | Y | Windows: Administrators UNIX: Superuser | M and A ^{#2} |
| Sets up the Web Console server. | <code>ajswbsetup</code> | Y | L | Windows: Administrators UNIX: Superuser | W |

| Function | Command name | Windows | UNIX | Required privileges | Supported products |
|---|-----------------------------|---------|------|--|--------------------|
| Sets up the JP1/AJS3 System Control Manager service and the JP1/AJS3 System Control Agent service | <code>ajssysctlsetup</code> | Y | Y | Windows: Administrators UNIX: Superuser | M and A |

Legend:

Y: Supported

S: Provided for the Solaris version only.

L: Provided for the Linux version only.

--: Not supported

M: JP1/AJS3 - Manager

A: JP1/AJS3 - Agent

W: JP1/AJS3 - Web Console

Note

On a Windows host, before you execute a command that must be executed by a user with administrator privileges, make sure that you open the Command Prompt window as an administrator. If the UAC function is disabled, you do not need to open the Command Prompt window as an administrator.

#1

Do not execute this command if a JP1 series product that requires JP1/Base is running.

#2

This command cannot be used for JP1/AJS3 - Agent Minimal Edition.

1.5.2 Commands used to customize environments

The following table lists the commands used to customize JP1/AJS3 environments based on operations:

Table 1–8: Commands used to customize environments

| Function | Command name | Windows | UNIX | Required privileges | Supported products |
|--|----------------------------|---------|------|--|--------------------|
| Changes and references the size of the trace log file. | <code>ajstrsetsz</code> | Y | Y | Windows: Administrators UNIX: Superuser | M |
| Changes the request source manager host name stored in the event action agent process when an event job or a custom event job is executed. | <code>jpoagoec</code> | Y | Y | Windows: Administrators UNIX: Superuser | M and A |
| Compresses the database in the job execution environment. | <code>jqqdbcond</code> | Y | Y | Windows: Administrators UNIX: Superuser | M |
| Changes the size of the trace log file for the JP1/AJS3 Check Manager service or the JP1/AJS3 Check Agent service. | <code>ajschktrsetsz</code> | Y | Y | Windows: Administrators UNIX: Superuser | M and A |

| Function | Command name | Windows | UNIX | Required privileges | Supported products |
|--|----------------------------|---------|------|--|--------------------|
| Deletes the information held by the event action control manager. | <code>jpomanevreset</code> | Y | Y | Windows: Administrators UNIX: Superuser | M |
| Analyzes the internal log of the event action control manager and displays agents that often send data to the manager, and information about start conditions. | <code>jpomanevshow</code> | Y | Y | Windows: Administrators UNIX: Superuser | M |

Legend:

Y: Supported

M: JP1/AJS3 - Manager

A: JP1/AJS3 - Agent

Note

On a Windows host, before you execute a command that must be executed by a user with administrator privileges, make sure that you open the Command Prompt window as an administrator. If the UAC function is disabled, you do not need to open the Command Prompt window as an administrator.

1.5.3 Commands used to control JP1/AJS3

The following table lists the commands used to control JP1/AJS3:

Table 1–9: Commands used to control JP1/AJS3

| Function | Command name | Windows | UNIX | Required privileges | Supported products |
|--|---------------------------------|---------|------|--|--------------------|
| Automatically starts JP1/AJS3 at a system start. | <code>jajs_start</code> | -- | Y | UNIX: Superuser | M and A |
| Automatically stops JP1/AJS3 at a system stop. | <code>jajs_stop</code> | -- | Y | UNIX: Superuser | M and A |
| Starts JP1/AJS3 in the logical host environment. | <code>jajs_start.cluster</code> | -- | Y | UNIX: Superuser | M and A |
| Stops JP1/AJS3 operating in the logical host environment. | <code>jajs_stop.cluster</code> | -- | Y | UNIX: Superuser | M and A |
| Starts the JP1/AJS3 process. | <code>jajs_spmd</code> | Y | Y | Windows: Administrators UNIX: Superuser | M and A |
| Terminates the JP1/AJS3 process. | <code>jajs_spmd_stop</code> | Y | Y | Windows: Administrators UNIX: Superuser | M and A |
| Starts a specific detailed process of the host service management function (<code>jajs_hstd</code>). | <code>jajs_hstd</code> | Y | Y | Windows: Administrators UNIX: Superuser | M |
| Terminates a specific detailed process of the host service management function (<code>jajs_hstd</code>). | <code>jajs_hstd_stop</code> | Y | Y | Windows: Administrators UNIX: Superuser | M |

| Function | Command name | Windows | UNIX | Required privileges | Supported products |
|--|-----------------------------------|---------|------|--|--------------------|
| Starts the scheduler service. | <code>ajsstart</code> | Y | Y | Windows: Administrators UNIX: Superuser | M |
| Terminates the scheduler service. | <code>ajsstop</code> | Y | Y | Windows: Administrators UNIX: Superuser | M |
| Changes the operating environment of the scheduler service temporarily. | <code>ajsalter</code> | Y | Y | Windows: Administrators UNIX: Superuser | M |
| Outputs the operating environment of the scheduler service to the standard output file. | <code>ajsstatus</code> | Y | Y | None | M |
| Extracts log records that match the specified conditions from the scheduler log, and outputs the extracted log records. | <code>ajslogprint</code> | Y | Y | None | M |
| Forcibly terminates the JP1/AJS3 process during operation in a cluster system. | <code>jajs_killall.cluster</code> | -- | Y | UNIX: Superuser | M and A |
| Confirms the JP1/AJS3 status (whether or not each component is started or terminated). | <code>jajs_spmd_status</code> | Y | Y | Windows: Administrators UNIX: Superuser | M and A |
| Outputs JP1/AJS3 operating information and information about environment setting parameters that take effect during operation. | <code>jajs_status</code> | Y | Y | None | M |
| Outputs JP1/AJS3 performance reports. | <code>ajsreport</code> | Y | Y | Windows: Administrators UNIX: Superuser | M |
| Starts JP1/AJS3 - View. | <code>ajs</code> | Y | -- | None | V |
| Starts the JP1/AJS3 Check Manager service or the JP1/AJS3 Check Agent service. | <code>ajschkstart</code> | -- | Y | UNIX: Superuser | M and A |
| Stops the JP1/AJS3 Check Manager service or the JP1/AJS3 Check Agent service. | <code>ajschkstop</code> | -- | Y | UNIX: Superuser | M and A |
| Changes the settings in an operation profile. | <code>ajsprofalter</code> | Y | Y | Windows: Administrators UNIX: Superuser | M |
| Checks the settings in an operation profile. | <code>ajsprofstatus</code> | Y | Y | None | M |
| Creates, changes, or deletes an email sending profile necessary for sending emails without using Outlook. | <code>jpomailprof</code> | Y | -- | Windows: Administrators | M and A |
| Enables the contents of the connection permission configuration file, and outputs | <code>jajs_pmtcon</code> | Y | Y | Windows: Administrators UNIX: Superuser | M and A |

| Function | Command name | Windows | UNIX | Required privileges | Supported products |
|---|------------------------------|---------|------|--|--------------------|
| a list of hosts that are permitted to connect. | <code>jajs_pmtcon</code> | Y | Y | Windows: Administrators UNIX: Superuser | M and A |
| Outputs the AJS administrator information that is set. | <code>jajsshoadminusr</code> | -- | Y | UNIX: Superuser | M and A |
| Starts the JP1/AJS3 Autonomous Agent Messenger service. | <code>ajsatmstart</code> | -- | Y | UNIX: Superuser | M and A |
| Stops the JP1/AJS3 Autonomous Agent Messenger service. | <code>ajsatmstop</code> | -- | Y | UNIX: Superuser | M and A |
| Starts the JP1/AJS3 Autonomous Agent service. | <code>ajsatstart</code> | -- | Y | UNIX: Superuser | M and A |
| Outputs the statuses of the JP1/AJS3 Autonomous Agent service and the JP1/AJS3 Autonomous Agent Messenger service. | <code>ajsatstatus</code> | -- | Y | None | M and A |
| Stops the JP1/AJS3 Autonomous Agent service. | <code>ajsatstop</code> | -- | Y | UNIX: Superuser | M and A |
| Lists the time zone IDs that can be specified in the environment settings file. | <code>ajswebtz</code> | -- | L | None | W |
| Lists the time zone IDs that can be specified in the environment settings file. | <code>ajswebtz.bat</code> | Y | -- | None | W |
| Starts the JP1/AJS3 HTTP Server service and the JP1/AJS3 Web Application Server service. | <code>jajs_web</code> | -- | L | UNIX: Superuser | W |
| Stops the JP1/AJS3 HTTP Server service and the JP1/AJS3 Web Application Server service. | <code>jajs_web_stop</code> | -- | L | UNIX: Superuser | W |
| Starts the JP1/AJS3 System Control Manager service and the JP1/AJS3 System Control Agent service. | <code>ajssysctlstart</code> | -- | Y | UNIX: Superuser | M and A |
| Obtains the information of the JP1/AJS3 System Control Manager service and the JP1/AJS3 System Control Agent service. | <code>ajssysctlstatus</code> | Y | Y | None | M and A |
| Stops the JP1/AJS3 System Control Manager service and the JP1/AJS3 System Control Agent service. | <code>ajssysctlstop</code> | -- | Y | UNIX: Superuser | M and A |

Legend:

Y: Supported

L: Provided for the Linux version only.

- : Not supported
- M: JP1/AJS3 - Manager
- A: JP1/AJS3 - Agent
- V: JP1/AJS3 - View
- W: JP1/AJS3 - Web Console

Note

On a Windows host, before you execute a command that must be executed by a user with administrator privileges, make sure that you open the Command Prompt window as an administrator. If the UAC function is disabled, you do not need to open the Command Prompt window as an administrator.

1.5.4 Commands used to manipulate units

The following table lists the commands used to manipulate units.

The privilege required to execute these commands depends on the JP1 privilege level for the user executing the command for the JP1 resource group name specified as the attribute of the target's unit. However, the execution privilege shown is not necessarily essential if the target's unit contains no JP1 resource group name or if the command-executing user has the superuser privileges (for UNIX systems) or is logged on as a member of the Administrators privileges (in Windows systems). For details about the execution privilege, see *6.4 Setting access permissions* in the *JP1/Automatic Job Management System 3 System Design (Work Tasks) Guide*.

Cautionary note

If the "Required privileges" column lists more than one privilege, you need only have one of the listed privileges to execute the command.

Table 1–10: Commands used to manipulate units

| Function | Command name | Windows | UNIX | Required privileges | Supported products |
|--|------------------------|---------|------|---|--------------------|
| Defines a unit. | <code>ajsdefine</code> | Y | Y | Destination of definition JP1_AJS_Admin JP1_AJS_Manager JP1_AJS_Editor Target and subsequent units (Forced change of a defined unit) JP1_AJS_Admin JP1_AJS_Manager JP1_AJS_Editor | M |
| Modifies the definition of a unit defined in a jobnet. | <code>ajschange</code> | Y | Y | Destination of change JP1_AJS_Admin JP1_AJS_Manager JP1_AJS_Editor At attribute change JP1_AJS_Admin Ownership privilege for units | M |
| Modifies the definition of a jobnet. | <code>ajschgnet</code> | Y | Y | Destination of change JP1_AJS_Admin JP1_AJS_Manager JP1_AJS_Editor | M |

| Function | Command name | Windows | UNIX | Required privileges | Supported products |
|---|------------------------|---------|------|---|--------------------|
| Modifies the definition of a job. | <code>ajschgjob</code> | Y | Y | Destination of change JP1_AJS_Admin JP1_AJS_Manager JP1_AJS_Editor | M |
| Copies, moves or renames a unit. | <code>ajscopy</code> | Y | Y | Destination of copy/move JP1_AJS_Admin JP1_AJS_Manager JP1_AJS_Editor Copy-target and subsequent units JP1_AJS_Admin JP1_AJS_Manager JP1_AJS_Editor JP1_AJS_Operator JP1_AJS_Guest Move-target and subsequent units JP1_AJS_Admin JP1_AJS_Manager JP1_AJS_Editor | M |
| Deletes a unit. | <code>ajsdelete</code> | Y | Y | Delete-target and subsequent units JP1_AJS_Admin JP1_AJS_Manager JP1_AJS_Editor | M |
| Outputs the name of a unit to the standard output file. | <code>ajsname</code> | Y | Y | Output target unit JP1_AJS_Admin JP1_AJS_Manager JP1_AJS_Editor JP1_AJS_Operator JP1_AJS_Guest | M |
| Outputs operating environment information of the scheduler service to the standard output file. | <code>ajsgtroot</code> | Y | Y | None | M |
| Outputs the definition of a unit to the standard output file. | <code>ajsprint</code> | Y | Y | Output-target and subsequent units JP1_AJS_Admin JP1_AJS_Manager JP1_AJS_Editor JP1_AJS_Operator JP1_AJS_Guest | M |
| Backs up a unit. | <code>ajsbackup</code> | Y | Y | Save-target and subsequent units JP1_AJS_Admin JP1_AJS_Manager JP1_AJS_Editor JP1_AJS_Operator JP1_AJS_Guest | M |

| Function | Command name | Windows | UNIX | Required privileges | Supported products |
|---|--------------------------|---------|------|---|--------------------|
| Deletes a backup box or backup file. | <code>ajsbkudel</code> | Y | Y | None | M |
| Restores a unit. | <code>ajsrestore</code> | Y | Y | Destination of recovery JP1_AJS_Admin JP1_AJS_Manager JP1_AJS_Editor Target and subsequent units (Forced change of a defined unit) JP1_AJS_Admin JP1_AJS_Manager JP1_AJS_Editor | M |
| Exports the registered execution-schedule information of a root jobnet. | <code>ajsrlexport</code> | Y | Y | JP1_AJS_Admin JP1_AJS_Manager JP1_AJS_Editor JP1_AJS_Operator JP1_AJS_Guest | M |
| Imports the registered execution-schedule information of a root jobnet. | <code>ajsrimport</code> | Y | Y | JP1_AJS_Admin JP1_AJS_Manager JP1_AJS_Operator | M |
| Defines calendar information for a job group. | <code>ajscalendar</code> | Y | Y | Destination of change JP1_AJS_Admin JP1_AJS_Manager JP1_AJS_Editor | M |
| Calculates multiple sets of calendar information, and then outputs the results to the standard output file using the format of the calendar information file. | <code>ajscalutil</code> | Y | Y | If a job group name is specified: JP1_AJS_Admin JP1_AJS_Manager JP1_AJS_Editor JP1_AJS_Operator JP1_AJS_Guest If a job group name is not specified: None | M |
| Defines a jobnet execution schedule for a period and then outputs it to the standard output file using the format of the schedule information parameter. | <code>ajsschedule</code> | Y | Y | Output-target and subsequent units JP1_AJS_Admin JP1_AJS_Manager JP1_AJS_Editor JP1_AJS_Operator JP1_AJS_Guest | M |
| Registers a defined jobnet for execution. | <code>ajsentry</code> | Y | Y | Manipulation-target and subsequent units JP1_AJS_Admin JP1_AJS_Manager JP1_AJS_Operator | M |
| Cancels the registration of a jobnet. | <code>ajsleave</code> | Y | Y | Manipulation-target and subsequent units | M |

| Function | Command name | Windows | UNIX | Required privileges | Supported products |
|--|----------------------------|---------|------|---|--------------------|
| Cancels the registration of a jobnet. | <code>ajsleave</code> | Y | Y | JP1_AJS_Admin JP1_AJS_Manager JP1_AJS_Operator | M |
| Suspends the root jobnet. Cancels the suspended state of the root jobnet. | <code>ajssuspend</code> | Y | Y | Manipulation-target and subsequent units JP1_AJS_Admin JP1_AJS_Manager JP1_AJS_Operator | M |
| Outputs information about a jobnet or job, including the execution history, current status, and next scheduled execution, to the standard output file. | <code>ajsshow</code> | Y | Y | Output-target and subsequent units JP1_AJS_Admin JP1_AJS_Manager JP1_AJS_Editor JP1_AJS_Operator JP1_AJS_Guest | M |
| Outputs the list of event jobs and custom event jobs being currently executed in the manager to the standard output file. | <code>jpomanjobshow</code> | Y | Y | UNIX: Superuser Windows: Administrators | M |
| Temporarily modifies a schedule defined for a jobnet, or the status of a job. | <code>ajsplan</code> | Y | Y | Manipulation-target and subsequent units JP1_AJS_Admin JP1_AJS_Manager JP1_AJS_Operator | M |
| Modifies the status of a job. | <code>ajschgstat</code> | Y | Y | Manipulation-target unit JP1_AJS_Admin JP1_AJS_Manager JP1_AJS_Operator | M |
| Stops the execution of a jobnet. | <code>ajsintrpt</code> | Y | Y | Manipulation-target and subsequent units JP1_AJS_Admin JP1_AJS_Manager JP1_AJS_Operator | M |
| Kills the execution of a job or jobnet. | <code>ajskill</code> | Y | Y | Manipulation-target and subsequent units JP1_AJS_Admin JP1_AJS_Manager JP1_AJS_Operator | M |
| Re-executes a job or a jobnet. | <code>ajsrerun</code> | Y | Y | Manipulation-target and subsequent units JP1_AJS_Admin JP1_AJS_Manager JP1_AJS_Operator | M |
| Exports a unit. | <code>ajsexport#</code> | Y | Y | Export-target and subsequent units JP1_AJS_Admin JP1_AJS_Manager JP1_AJS_Editor | M |

| Function | Command name | Windows | UNIX | Required privileges | Supported products |
|---|-------------------------|---------|------|---|--------------------|
| Exports a unit. | <code>ajsexport#</code> | Y | Y | JP1_AJS_Operator JP1_AJS_Guest | M |
| Imports a unit. | <code>ajsimport#</code> | Y | Y | Destination of import JP1_AJS_Admin JP1_AJS_Manager JP1_AJS_Editor | M |
| Starts execution of the definition pre-check and displays the state of execution. | <code>ajschkdef</code> | Y | Y | Windows: Administrators UNIX: Superuser | M |
| Performs release entry or cancellation, or outputs release information. | <code>ajsrelease</code> | Y | Y | For release entry and cancellation: JP1_AJS_Admin JP1_AJS_Manager JP1_AJS_Editor JP1_AJS_Operator For outputting release information: JP1_AJS_Admin JP1_AJS_Manager JP1_AJS_Editor JP1_AJS_Operator JP1_AJS_Guest | M |
| Outputs a list of temporary change information made to a root jobnet and its lower units to the standard output file. | <code>ajsplanout</code> | Y | Y | For root jobnets: JP1_AJS_Admin JP1_AJS_Manager JP1_AJS_Editor JP1_AJS_Operator JP1_AJS_Guest | M |

Legend:

Y: Supported

M: JP1/AJS3 - Manager

Note

On a Windows host, before you execute a command that must be executed by a user with administrator privileges, make sure that you open the Command Prompt window as an administrator. If the UAC function is disabled, you do not need to open the Command Prompt window as an administrator.

#

These commands are provided by JP1/AJS3 for the packaging function. Use them for distributing a unit in combination with JP1/Software Distribution. You can only use these commands in a batch file or shell script for the packaging function.

1.5.5 Commands used to operate execution agents

The following table lists the commands used to operate execution agents.

Table 1–11: Commands used to operate execution agents

| Function | Command name | Windows | UNIX | Required privileges | Supported products |
|--|----------------------------|---------|------|---|--------------------|
| Adds an execution agent. | <code>ajsagtadd</code> | Y | Y | JP1_JPQ_Admin | M |
| Deletes an execution agent. | <code>ajsagtdel</code> | Y | Y | JP1_JPQ_Admin | M |
| Outputs information such as the job execution status on an execution agent to the standard output. | <code>ajsagtshow</code> | Y | Y | JP1_JPQ_Admin JP1_JPQ_Operator JP1_JPQ_User or Windows: Administrators UNIX: Superuser | M |
| Changes the execution agent settings or the job transfer restriction status. | <code>ajsagtalt</code> | Y | Y | JP1_JPQ_Admin JP1_JPQ_Operator | M |
| Starts and stops a communication status check for an execution agent, and outputs the status of the execution agent to the standard output. | <code>ajsagtcheck</code> | Y | Y | Windows: Administrators UNIX: Superuser | M |
| Outputs execution agent definition information in CSV format to the standard output file. | <code>ajsagtprint</code> | Y | Y | JP1_JPQ_Admin JP1_JPQ_Operator JP1_JPQ_User or Windows: Administrators UNIX: Superuser | M |
| Outputs a list of event jobs and custom event jobs being executed by an execution agent to the standard output. | <code>jpoagtjobshow</code> | Y | Y | Windows: Administrators UNIX: Superuser | M and A |
| Outputs, to the standard output, information indicating whether the agent is set up as a destination agent at the broadcast destination or as a broadcast agent. | <code>ajsfxbcstatus</code> | Y | Y | None | M and A |

Legend:

Y: Supported

M: JP1/AJS3 - Manager

A: JP1/AJS3 - Agent

Note

On a Windows host, before you execute a command that must be executed by a user with administrator privileges, make sure that you open the Command Prompt window as an administrator. If the UAC function is disabled, you do not need to open the Command Prompt window as an administrator.

1.5.6 Commands used to execute jobs

The following table lists the commands used to execute a single job, not a jobnet.

Command execution requires you to register the OS user executing commands with the authentication server as a JP1 user. The privilege required to execute commands is shown on a command basis. As required, you should give the privilege to the JP1 user. For details about the execution privilege, see *6.4 Setting access permissions* in the *JP1/Automatic Job Management System 3 System Design (Work Tasks) Guide*.

Cautionary note

If the "Required privileges" column lists more than one privilege, you need only have one of the listed privileges to execute the command.

Table 1–12: Commands used to execute jobs

| Function | Command name | Windows | UNIX | Required privileges | Supported products |
|--|----------------------|---------|------|---------------------|--------------------|
| Executes the program specified as an argument, and saves the return code of the program in a temporary file. | <code>jplexec</code> | Y | -- | None | M and A |
| Returns the return code that was saved by the <code>jplexec</code> command. | <code>jplexit</code> | Y | -- | None | M and A |

Legend:

Y: Supported

--: Not supported

M: JP1/AJS3 - Manager

A: JP1/AJS3 - Agent

Note

On a Windows host, before you execute a command that must be executed by a user with administrator privileges, make sure that you open the Command Prompt window as an administrator. If the UAC function is disabled, you do not need to open the Command Prompt window as an administrator.

1.5.7 Commands used to manipulate the embedded database

The following table lists the commands used to manipulate the embedded database:

Table 1–13: Commands used to manipulate the embedded database

| Function | Command name | Windows | UNIX | Required privileges | Supported products |
|---|-----------------------------|---------|------|--|--------------------|
| Obtains the backup of the embedded database. | <code>ajsembdbbackup</code> | Y | Y | Windows: Administrators UNIX: Superuser | M |
| Monitors the embedded database. | <code>ajsembdbstatus</code> | Y | Y | Windows: Administrators UNIX: Superuser | M |
| Manipulates the system log of the embedded database. | <code>ajsembdboplog</code> | Y | Y | Windows: Administrators UNIX: Superuser | M |
| Creates a backup of the embedded database while JP1/AJS3 is running, if the backup enhancement function is enabled. | <code>jajs_dbbackup</code> | Y | Y | Windows: Administrators UNIX: Superuser, AJS Administrator | M |

| Function | Command name | Windows | UNIX | Required privileges | Supported products |
|---|------------------------------|---------|------|---|--------------------|
| Restores the embedded database by using backup data that was created while JP1/AJS3 was running, if the backup enhancement function is enabled. | <code>jajs_dbrestore</code> | Y | Y | Windows: Administrators UNIX: Superuser, AJS Administrator | M |
| Backs up the embedded database or restores the embedded database using the backup and the unload log file. | <code>ajsembdbrstr</code> | Y | Y | Windows: Administrators UNIX: Superuser | M |
| Unloads and reloads the data in the embedded database. | <code>ajsembdbrorg</code> | Y | Y | Windows: Administrators UNIX: Superuser | M |
| Maintains the embedded database. | <code>ajsembdbreclaim</code> | Y | Y | Windows: Administrators UNIX: Superuser | M |
| Expands the database areas in the embedded database. | <code>ajsembdbaddarea</code> | Y | Y | Windows: Administrators UNIX: Superuser | M |
| Expands the system files for the embedded database. | <code>ajsembdbaddlog</code> | Y | Y | Windows: Administrators UNIX: Superuser | M |
| Stops the embedded database. | <code>ajsembdbstop</code> | Y | Y | Windows: Administrators UNIX: Superuser | M |
| Starts the embedded database. | <code>ajsembdbstart</code> | Y | Y | Windows: Administrators UNIX: Superuser | M |
| Cancels the execution of an embedded-database command. | <code>ajsembdbcancel</code> | Y | Y | Windows: Administrators UNIX: Superuser | M |

Legend:

Y: Supported

M: JP1/AJS3 - Manager

Note

On a Windows host, before you execute a command that must be executed by a user with administrator privileges, make sure that you open the Command Prompt window as an administrator. If the UAC function is disabled, you do not need to open the Command Prompt window as an administrator.

1.5.8 Command used to manipulate the external database

The following table lists the command used to manipulate the external database.

Table 1–14: Command used to manipulate the external database

| Function | Command name | Windows | UNIX | Required privileges | Supported products |
|--|-------------------------|---------|------|--|--------------------|
| Displays connection information of the external database connected to JP1/AJS3 - Manager, sets a connection relation | <code>jajs_extdb</code> | Y | L | Windows: Administrators UNIX: Superuser | M |

| Function | Command name | Windows | UNIX | Required privileges | Supported products |
|---|-------------------------|---------|------|--|--------------------|
| between JP1/AJS3 - Manager and the database on an external database, and cancels the execution-suppression start status of jobs (this command is used only when external database is used). | <code>jajs_extdb</code> | Y | L | Windows: Administrators UNIX: Superuser | M |

Legend:

Y: Supported

L: Provided for the Linux version only.

M: JP1/AJS3 - Manager

1.5.9 Commands used when an error occurs

The following table lists the commands used when an error occurs.

Table 1–15: Commands used when an error occurs

| Function | Command name | Windows | UNIX | Required privileges | Supported products |
|---|---|---------|------|-------------------------|--------------------|
| Collects information necessary for analyzing the core dump. | <code>ajs2collectcore</code> | -- | Y | UNIX: Superuser | M and A |
| Collects the necessary data when a failure occurs. | <code>jajs_log</code> or <code>_04</code> | -- | Y | UNIX: Superuser | M, A, and W |
| | <code>jajs_log.bat</code> or <code>_04.bat</code> | Y | -- | Windows: Administrators | M, A, V, and W |

Legend:

Y: Supported

--: Not supported

M: JP1/AJS3 - Manager

A: JP1/AJS3 - Agent

V: JP1/AJS3 - View

W: JP1/AJS3 - Web Console

1.5.10 Commands used during special operation

This subsection shows the commands used during special operation such as when an old-version compatibility function or an optional function is being used.

(1) Commands available in an execution environment for queue or submit jobs

The following table lists the commands available in an execution environment for queue or submit jobs.

Note that to execute a command other than the `jqexport`, `jqimport`, and `jajs_maintain` commands, the OS user who executes the command must be registered as a JP1 user on the authentication server. Also make sure that the JP1 user is granted the proper permissions to execute the command. For details about command execution permissions, see 6.4 *Setting access permissions* in the *JP1/Automatic Job Management System 3 System Design (Work Tasks) Guide*.

Table 1–16: Commands used during special operation (commands available in an execution environment for queue or submit jobs)

| Function | Command name | Windows | UNIX | Required privileges | Supported products |
|---|----------------------------|---------|------|---|--------------------|
| Outputs the current job execution environment to a file. | <code>jqexport</code> | Y | Y | Windows: Administrators UNIX: Superuser | M |
| Defines the job execution environment (job execution agents, queues, and exclusive execution resources) collectively using the job execution environment configuration definition file (<code>jqsetup.conf</code>). | <code>jqimport</code> | Y | Y | Windows: Administrators UNIX: Superuser | M |
| Performs maintenance on JP1/AJS3. | <code>jajs_maintain</code> | Y | Y | Windows: Administrators UNIX: Superuser | M |
| Registers a submit job. | <code>jqjobsub</code> | Y | Y | Destination of a request to register a submit job JP1_JPQ_Admin JP1_JPQ_Operator JP1_JPQ_User | M and A |
| Cancels or kills the execution of a job. | <code>jqjobcan</code> | Y | Y | Destination of a request to cancel a job JP1_JPQ_Admin JP1_JPQ_Operator JP1_JPQ_User ^{#1} However, if the <code>-em</code> option is specified, the following privileges are required (and the above privileges are not required). Windows: Administrators ^{#2} UNIX: Superuser | M and A |
| Holds, or unholds the execution of a job. | <code>jqjobalt</code> | Y | Y | Destination of a request to hold/unhold a job JP1_JPQ_Admin JP1_JPQ_Operator JP1_JPQ_User ^{#1} | M and A |
| Moves a job. | <code>jqjobmove</code> | Y | Y | Destination of a request to move a job JP1_JPQ_Admin JP1_JPQ_Operator JP1_JPQ_User ^{#1} | M and A |
| Outputs information about a particular job to the standard output file. | <code>jqjobget</code> | Y | Y | Destination of a request to acquire job information JP1_JPQ_Admin | M and A |

| Function | Command name | Windows | UNIX | Required privileges | Supported products |
|---|-----------------------------|---------|------|--|--------------------|
| Outputs information about a particular job to the standard output file. | <code>jpgqjobget</code> | Y | Y | JP1_JPQ_Operator JP1_JPQ_User ^{#1} | M and A |
| Outputs a list of uncompleted jobs to the standard output file. | <code>jpgqjobshow</code> | Y | Y | Destination of a request to acquire job information JP1_JPQ_Admin JP1_JPQ_Operator JP1_JPQ_User ^{#1} | M and A |
| Outputs a list of completed jobs to the standard output file. | <code>jpgqendjobshow</code> | Y | Y | Destination of a request to acquire job information JP1_JPQ_Admin JP1_JPQ_Operator JP1_JPQ_User ^{#1} | M and A |
| Deletes information about completed jobs from the database. | <code>jpgqjobdel</code> | Y | Y | Destination of a request to delete a job JP1_JPQ_Admin JP1_JPQ_Operator | M and A |
| Opens a queue. | <code>jpgqqueueopen</code> | Y | Y | Destination of a request to open a queue JP1_JPQ_Admin JP1_JPQ_Operator However, if the <code>-em</code> option is specified, the following privileges are required (and the above privileges are not required). Windows: Administrators ^{#2} UNIX: Superuser | M and A |
| Closes a queue. | <code>jpgqqueueclose</code> | Y | Y | Destination of a request to close a queue JP1_JPQ_Admin JP1_JPQ_Operator However, if the <code>-em</code> option is specified, the following privileges are required (and the above privileges are not required). Windows: Administrators ^{#2} UNIX: Superuser | M and A |
| Outputs queue information to the standard output file. | <code>jpgqqueshow</code> | Y | Y | Destination of a request to acquire queue information JP1_JPQ_Admin JP1_JPQ_Operator JP1_JPQ_User However, if the <code>-em</code> option is specified, the following privileges are required (and the above privileges are not required). Windows: Administrators ^{#2} UNIX: Superuser | M and A |

| Function | Command name | Windows | UNIX | Required privileges | Supported products |
|--|---------------------------|---------|------|--|--------------------|
| Adds a queue. | <code>jpqqueadd</code> | Y | Y | Destination of a request to add a queue JP1_JPQ_Admin | M |
| Deletes a queue. | <code>jpqquedel</code> | Y | Y | Destination of a request to delete a queue JP1_JPQ_Admin | M |
| Changes a queue definition. | <code>jpqquealt</code> | Y | Y | Destination of a request to change a queue definition JP1_JPQ_Admin However, if the <code>-em</code> option is specified, the following privileges are required (and the above privilege is not required). Windows: Administrators ^{#2} UNIX: Superuser | M |
| Connects a queue to an agent; otherwise, changes the level of priority to a connected agent. | <code>jpqagtlink</code> | Y | Y | Destination of a request to connect an agent JP1_JPQ_Admin However, if the <code>-em</code> option is specified, the following privileges are required (and the above privilege is not required). Windows: Administrators ^{#2} UNIX: Superuser | M |
| Releases the connection between a queue and an agent. | <code>jpqagtunlink</code> | Y | Y | Destination of a request to cancel an agent connection JP1_JPQ_Admin | M |
| Outputs information about the agent host to the standard output file. | <code>jpqagtshow</code> | Y | Y | Destination of a request to acquire agent information JP1_JPQ_Admin However, if the <code>-em</code> option is specified, the following privileges are required (and the above privilege is not required). Windows: Administrators ^{#2} UNIX: Superuser | M and A |
| Adds an agent and creates a default queue at the same time. | <code>jpqagtadd</code> | Y | Y | Destination of a request to add an agent JP1_JPQ_Admin | M |
| Deletes an agent and deletes the default queue at the same time. | <code>jpqagtdel</code> | Y | Y | Destination of a request to delete an agent JP1_JPQ_Admin | M |
| Modifies the number of concurrently-executable jobs. | <code>jpqagtalt</code> | Y | Y | Destination of a request to change the number of concurrently-executable jobs JP1_JPQ_Admin However, if the <code>-em</code> option is specified, the following | M and A |

| Function | Command name | Windows | UNIX | Required privileges | Supported products |
|--|-------------------------|---------|------|--|--------------------|
| Modifies the number of concurrently-executable jobs. | <code>jpgagtalt</code> | Y | Y | privileges are required (and the above privilege is not required). Windows: Administrators ^{#2} UNIX: Superuser | M and A |
| Outputs information about exclusive execution resources to the standard output file. | <code>jpgresshow</code> | Y | Y | Destination of a request to acquire exclusive execution resources JP1_JPQ_Admin JP1_JPQ_Operator JP1_JPQ_User | M |
| Adds exclusive execution resources. | <code>jpgresadd</code> | Y | Y | Destination of a request to add exclusive execution resources JP1_JPQ_Admin | M |
| Deletes exclusive execution resources. | <code>jpgresdel</code> | Y | Y | Destination of a request to delete exclusive execution resources JP1_JPQ_Admin | M |

Legend:

Y: Supported

M: JP1/AJS3 - Manager

A: JP1/AJS3 - Agent

#1

With JP1_JPQ_User permission, the user can operate or view only jobs submitted by the user himself or herself.

#2

On a Windows host, before you execute a command that must be executed by a user with administrator privileges, make sure that you open the Command Prompt window as an administrator. If the UAC function is disabled, you do not need to open the Command Prompt window as an administrator.

(2) Commands available when queueless jobs are used

The following table lists the commands available when queueless jobs are used.

Table 1–17: Commands used during special operation (commands available when queueless jobs are used)

| Function | Command name | Windows | UNIX | Required privileges | Supported products |
|---|--------------------------|---------|------|--|--------------------|
| Sets up the execution environment for queueless jobs. | <code>ajsqlsetup</code> | Y | Y | Windows: Administrators UNIX: Superuser | M and A |
| Temporarily modifies the operating environment for the queueless agent service. | <code>ajsqlalter</code> | Y | Y | Windows: Administrators UNIX: Superuser | M and A |
| Adds hosts to be processed by the queueless agent service. | <code>ajsqlattach</code> | Y | Y | Windows: Administrators UNIX: Superuser | M and A |

| Function | Command name | Windows | UNIX | Required privileges | Supported products |
|--|----------------------------|---------|------|--|--------------------|
| Disconnects hosts processed by the queueless agent service. | <code>ajsqldetach</code> | Y | Y | Windows: Administrators UNIX: Superuser | M and A |
| Starts the queueless file transfer service. | <code>ajsqlftpstart</code> | -- | Y | UNIX: Superuser | M |
| Stops the queueless file transfer service. | <code>ajsqlftpstop</code> | Y | Y | Windows: Administrators UNIX: Superuser | M |
| Starts the JP1/AJS3 Queueless Agent service. | <code>ajsqlstart</code> | -- | Y | UNIX: Superuser | M and A |
| Stops the queueless agent service. | <code>ajsqlstop</code> | Y | Y | Windows: Administrators UNIX: Superuser | M and A |
| Outputs detailed information about the queueless agent service. | <code>ajsqlstatus</code> | Y | Y | None | M and A |
| Modifies the size of the trace log file for the queueless agent service. | <code>ajsqltrsetsz</code> | Y | Y | Windows: Administrators UNIX: Superuser | M and A |
| Changes the size of the internal log file for execution of queueless jobs. | <code>ajsqlxecsetsz</code> | Y | Y | Windows: Administrators UNIX: Superuser | M and A |

Legend:

Y: Supported

--: Not supported

M: JP1/AJS3 - Manager

A: JP1/AJS3 - Agent

#

These commands cannot be used for JP1/AJS3 - Agent Minimal Edition.

(3) Commands available during an operation test

The following table lists the commands available during an operation test.

Table 1–18: Commands used during special operation (commands available during an operation test)

| Function | Command name | Windows | UNIX | Required privileges | Supported products |
|--|-----------------------------|---------|------|--|--------------------|
| Changes and references the local time and date of the scheduler service. | <code>ajsqllocaldate</code> | Y | Y | Windows: Administrators UNIX: Superuser | M |

Legend:

Y: Supported

M: JP1/AJS3 - Manager

1.6 Prerequisites to use commands

The following tables list the services you must have started before executing commands:

Table 1–19: Services you must have started before executing commands

| Command name | JP1/AJS3 ^{#1} | Scheduler service | HP NNM ^{#2} | Qa | Qf | CHm | CHa | At | Atm | Scm | Sca |
|---------------------------------|------------------------|-------------------|----------------------|----|----|-----|-----|----|-----|-----|-----|
| ajs | -- | -- | -- | -- | -- | -- | -- | -- | -- | -- | -- |
| ajs2collectcore (UNIX only) | -- | -- | -- | -- | -- | -- | -- | -- | -- | -- | -- |
| ajsagtadd | Y | -- | -- | -- | -- | -- | -- | -- | -- | -- | -- |
| ajsagtalt | Y | -- | -- | -- | -- | -- | -- | -- | -- | -- | -- |
| ajsagtcheck | Y | -- | -- | -- | -- | -- | -- | -- | -- | -- | -- |
| ajsagtdel | Y | -- | -- | -- | -- | -- | -- | -- | -- | -- | -- |
| ajsagtprint | Y | -- | -- | -- | -- | -- | -- | -- | -- | -- | -- |
| ajsagtshow | Y | -- | -- | -- | -- | -- | -- | -- | -- | -- | -- |
| ajs_adapter_setup ^{#3} | -- | -- | -- | -- | -- | -- | -- | -- | -- | -- | -- |
| ajsalter | Y | Y ^{#6} | -- | -- | -- | -- | -- | -- | -- | -- | -- |
| ajsatmstart (Linux only) | -- | -- | -- | -- | -- | -- | -- | -- | -- | -- | -- |
| ajsatmstop (Linux only) | -- | -- | -- | -- | -- | -- | -- | -- | Y | -- | -- |
| ajsatsetup | -- | -- | -- | -- | -- | -- | -- | -- | -- | -- | -- |
| ajsatstart (Linux only) | -- | -- | -- | -- | -- | -- | -- | -- | -- | -- | -- |
| ajsatstatus (Linux only) | -- | -- | -- | -- | -- | -- | -- | -- | -- | -- | -- |
| ajsatstop (Linux only) | -- | -- | -- | -- | -- | -- | -- | Y | -- | -- | -- |
| ajsbackup | -- | -- | -- | -- | -- | -- | -- | -- | -- | -- | -- |
| ajsbkudel | -- | -- | -- | -- | -- | -- | -- | -- | -- | -- | -- |
| ajscalendar | Y | -- | -- | -- | -- | -- | -- | -- | -- | -- | -- |
| ajscalutil | Y ^{#7} | -- | -- | -- | -- | -- | -- | -- | -- | -- | -- |
| ajschange | Y | -- | -- | -- | -- | -- | -- | -- | -- | -- | -- |
| ajschgjob | Y | -- | -- | -- | -- | -- | -- | -- | -- | -- | -- |
| ajschgnet | Y | -- | -- | -- | -- | -- | -- | -- | -- | -- | -- |
| ajschgstat | Y | Y | -- | -- | -- | -- | -- | -- | -- | -- | -- |
| ajschkdef | Y | -- | -- | -- | -- | Y | Y | -- | -- | -- | -- |
| ajschksetup ^{#3} | -- | -- | -- | -- | -- | -- | -- | -- | -- | -- | -- |

| Command name | JP1/AJS3#1 | Scheduler service | HP NNM#2 | Qa | Q f | C H m | C H a | At | Atm | Sc m | Sca |
|----------------------------|------------|-------------------|----------|----|-----|-------|-------|----|-----|------|-----|
| ajschkstart (UNIX only) | -- | -- | -- | -- | -- | -- | -- | -- | -- | -- | -- |
| ajschkstop (UNIX only) | -- | -- | -- | -- | -- | Y | Y | -- | -- | -- | -- |
| ajschktrsetsz | -- | -- | -- | -- | -- | -- | -- | -- | -- | -- | -- |
| ajscnvdbexport#3 | -- | -- | -- | -- | -- | -- | -- | -- | -- | -- | -- |
| ajscnvdbimport#3 | -- | -- | -- | -- | -- | -- | -- | -- | -- | -- | -- |
| ajscopy | Y | -- | -- | -- | -- | -- | -- | -- | -- | -- | -- |
| ajsdefine | Y | -- | -- | -- | -- | -- | -- | -- | -- | -- | -- |
| ajsdelete | Y | -- | -- | -- | -- | -- | -- | -- | -- | -- | -- |
| ajsembdbaddarea | -- | -- | -- | -- | -- | -- | -- | -- | -- | -- | -- |
| ajsembdbaddlog | -- | -- | -- | -- | -- | -- | -- | -- | -- | -- | -- |
| ajsembdbbackup#5 | -- | -- | -- | -- | -- | -- | -- | -- | -- | -- | -- |
| ajsembdbbuild#3 | -- | -- | -- | -- | -- | -- | -- | -- | -- | -- | -- |
| ajsembdbcancel | -- | -- | -- | -- | -- | -- | -- | -- | -- | -- | -- |
| ajsembdbidlist#3 | -- | -- | -- | -- | -- | -- | -- | -- | -- | -- | -- |
| ajsembdbinstl#3 | -- | -- | -- | -- | -- | -- | -- | -- | -- | -- | -- |
| ajsembdboplog | -- | -- | -- | -- | -- | -- | -- | -- | -- | -- | -- |
| ajsembdbreclaim | -- | -- | -- | -- | -- | -- | -- | -- | -- | -- | -- |
| ajsembdbrorg | -- | -- | -- | -- | -- | -- | -- | -- | -- | -- | -- |
| ajsembdbrstr#5 | -- | -- | -- | -- | -- | -- | -- | -- | -- | -- | -- |
| ajsembdbsetup#3 | -- | -- | -- | -- | -- | -- | -- | -- | -- | -- | -- |
| ajsembdbstart | -- | -- | -- | -- | -- | -- | -- | -- | -- | -- | -- |
| ajsembdbstatus | -- | -- | -- | -- | -- | -- | -- | -- | -- | -- | -- |
| ajsembdbstop | -- | -- | -- | -- | -- | -- | -- | -- | -- | -- | -- |
| ajsembdbuninstl#3 | -- | -- | -- | -- | -- | -- | -- | -- | -- | -- | -- |
| ajsembdbunset#3 | -- | -- | -- | -- | -- | -- | -- | -- | -- | -- | -- |
| ajsentry | Y | Y | -- | -- | -- | -- | -- | -- | -- | -- | -- |
| ajsexport | Y | -- | -- | -- | -- | -- | -- | -- | -- | -- | -- |
| ajsfxbcstatus | -- | -- | -- | -- | -- | -- | -- | -- | -- | -- | -- |
| ajsgtroot | -- | -- | -- | -- | -- | -- | -- | -- | -- | -- | -- |
| ajsimport | Y | -- | -- | -- | -- | -- | -- | -- | -- | -- | -- |
| ajsintrpt | Y | Y | -- | -- | -- | -- | -- | -- | -- | -- | -- |
| ajskill | Y | Y | -- | -- | -- | -- | -- | -- | -- | -- | -- |

| Command name | JP1/AJS3#1 | Scheduler service | HP NNM#2 | Qa | Q f | C H m | C H a | At | Atm | Sc m | Sca |
|-------------------------------|------------|-------------------|----------|----|-----|-------|-------|----|-----|------|-----|
| ajsleave | Y | Y | -- | -- | -- | -- | -- | -- | -- | -- | -- |
| ajslocaldate#4 | -- | -- | -- | -- | -- | -- | -- | -- | -- | -- | -- |
| ajslogprint | -- | -- | -- | -- | -- | -- | -- | -- | -- | -- | -- |
| ajsname | Y | -- | -- | -- | -- | -- | -- | -- | -- | -- | -- |
| ajsplan | Y | Y | -- | -- | -- | -- | -- | -- | -- | -- | -- |
| ajsplanout | Y | -- | -- | -- | -- | -- | -- | -- | -- | -- | -- |
| ajsprint | Y | -- | -- | -- | -- | -- | -- | -- | -- | -- | -- |
| ajsprofalter | Y | -- | -- | -- | -- | -- | -- | -- | -- | -- | -- |
| ajsprofstatus | Y | -- | -- | -- | -- | -- | -- | -- | -- | -- | -- |
| ajsqalalter#4 | -- | -- | -- | Y | -- | -- | -- | -- | -- | -- | -- |
| ajsqattach#4 | -- | -- | -- | Y | -- | -- | -- | -- | -- | -- | -- |
| ajsqldetach#4 | -- | -- | -- | Y | -- | -- | -- | -- | -- | -- | -- |
| ajsqlexecsetsz#4 | -- | -- | -- | -- | -- | -- | -- | -- | -- | -- | -- |
| ajsqftpstart#4 (UNIX only) | -- | -- | -- | -- | -- | -- | -- | -- | -- | -- | -- |
| ajsqftpstop#4 | -- | -- | -- | -- | Y | -- | -- | -- | -- | -- | -- |
| ajsqsetup#4 | -- | -- | -- | -- | -- | -- | -- | -- | -- | -- | -- |
| ajsqstart#4 (UNIX only) | -- | -- | -- | -- | -- | -- | -- | -- | -- | -- | -- |
| ajsqstatus#4 | -- | -- | -- | -- | -- | -- | -- | -- | -- | -- | -- |
| ajsqstop#4 | -- | -- | -- | Y | -- | -- | -- | -- | -- | -- | -- |
| ajsqtrsetsz#4 | -- | -- | -- | -- | -- | -- | -- | -- | -- | -- | -- |
| ajsrelease | Y | Y#8 | -- | -- | -- | -- | -- | -- | -- | -- | -- |
| ajsreport | -- | -- | -- | -- | -- | -- | -- | -- | -- | -- | -- |
| ajsrerun | Y | Y | -- | -- | -- | -- | -- | -- | -- | -- | -- |
| ajsrestore | Y | -- | -- | -- | -- | -- | -- | -- | -- | -- | -- |
| ajsrgexport | Y | -- | -- | -- | -- | -- | -- | -- | -- | -- | -- |
| ajsrgimport | Y | Y | -- | -- | -- | -- | -- | -- | -- | -- | -- |
| ajsschedule | Y | -- | -- | -- | -- | -- | -- | -- | -- | -- | -- |
| ajssetup#3 | -- | -- | -- | -- | -- | -- | -- | -- | -- | -- | -- |
| ajsshow | Y | -- | -- | -- | -- | -- | -- | -- | -- | -- | -- |
| ajsstart | Y | -- | -- | -- | -- | -- | -- | -- | -- | -- | -- |
| ajsstatus | Y | -- | -- | -- | -- | -- | -- | -- | -- | -- | -- |

| Command name | JP1/AJS3#1 | Scheduler service | HP NNM#2 | Qa | Q f | C H m | C H a | At | Atm | Sc m | Sca |
|---|------------|-------------------|----------|----|-----|-------|-------|----|-----|------|-----|
| ajsstop | Y | Y | -- | -- | -- | -- | -- | -- | -- | -- | -- |
| ajssuspend | Y | Y | -- | -- | -- | -- | -- | -- | -- | -- | -- |
| ajssysctlsetup#3 | -- | -- | -- | -- | -- | -- | -- | -- | -- | -- | -- |
| Ajssysctlstart (UNIX only) | -- | -- | -- | -- | -- | -- | -- | -- | -- | -- | -- |
| ajssysctlstatus | -- | -- | -- | -- | -- | -- | -- | -- | -- | -- | -- |
| Ajssysctlstop (UNIX only) | -- | -- | -- | -- | -- | -- | -- | -- | -- | Y | Y |
| ajstrsetsz | -- | -- | -- | -- | -- | -- | -- | -- | -- | -- | -- |
| ajswebsetup | -- | -- | -- | -- | -- | -- | -- | -- | -- | -- | -- |
| ajswebtz (Linux only) | -- | -- | -- | -- | -- | -- | -- | -- | -- | -- | -- |
| ajswebtz.bat (Windows only) | -- | -- | -- | -- | -- | -- | -- | -- | -- | -- | -- |
| jajs_config#3 | -- | -- | -- | -- | -- | -- | -- | -- | -- | -- | -- |
| jajs_dbbackup | Y | -- | -- | -- | -- | -- | -- | -- | -- | -- | -- |
| jajs_dbrestore | -- | -- | -- | -- | -- | -- | -- | -- | -- | -- | -- |
| jajs_hstd | Y | -- | -- | -- | -- | -- | -- | -- | -- | -- | -- |
| jajs_hstd_stop | Y | -- | -- | -- | -- | -- | -- | -- | -- | -- | -- |
| jajs_killall.cluster (UNIX only) | -- | -- | -- | -- | -- | -- | -- | -- | -- | -- | -- |
| jajs_log or _04 (UNIX only) | -- | -- | -- | -- | -- | -- | -- | -- | -- | -- | -- |
| jajs_log.bat or _04.bat (Windows only) | -- | -- | -- | -- | -- | -- | -- | -- | -- | -- | -- |
| jajs_maintain#4 | -- | -- | -- | -- | -- | -- | -- | -- | -- | -- | -- |
| jajs_migrate#3 | -- | -- | -- | -- | -- | -- | -- | -- | -- | -- | -- |
| jajs_pmtcon#9 | Y | -- | -- | Y | -- | -- | -- | -- | -- | -- | -- |
| jajs_rpenvexport#3 | -- | -- | -- | -- | -- | -- | -- | -- | -- | -- | -- |
| jajs_rpenvimport#3 | -- | -- | -- | -- | -- | -- | -- | -- | -- | -- | -- |
| jajs_rpsite#3 | -- | -- | -- | -- | -- | -- | -- | -- | -- | -- | -- |
| jajs_setup#3 | -- | -- | -- | -- | -- | -- | -- | -- | -- | -- | -- |
| jajs_setup_cluster#3 | -- | -- | -- | -- | -- | -- | -- | -- | -- | -- | -- |
| jajs_spmd | Y#10 | -- | -- | -- | -- | -- | -- | -- | -- | -- | -- |
| jajs_spmd_status | -- | -- | -- | -- | -- | -- | -- | -- | -- | -- | -- |

| Command name | JP1/AJS3#1 | Scheduler service | HP NNM#2 | Qa | Qf | CHm | CHa | At | Atm | Scm | Sca |
|--|------------|-------------------|----------|----|----|-----|-----|----|-----|-----|-----|
| jajs_spmd_stop | Y | -- | -- | -- | -- | -- | -- | -- | -- | -- | -- |
| jajs_start (UNIX only) | -- | -- | -- | -- | -- | -- | -- | -- | -- | -- | -- |
| jajs_start.cluster (UNIX only) | -- | -- | -- | -- | -- | -- | -- | -- | -- | -- | -- |
| jajs_status | Y | -- | -- | -- | -- | -- | -- | -- | -- | -- | -- |
| jajs_stop (UNIX only) | Y | -- | -- | -- | -- | -- | -- | -- | -- | -- | -- |
| jajs_stop.cluster (UNIX only) | Y | -- | -- | -- | -- | -- | -- | -- | -- | -- | -- |
| jajs_web (Linux only) | -- | -- | -- | -- | -- | -- | -- | -- | -- | -- | -- |
| jajs_web_stop (Linux only) | -- | -- | -- | -- | -- | -- | -- | -- | -- | -- | -- |
| jajsacfg#4 | -- | -- | -- | -- | -- | -- | -- | -- | -- | -- | -- |
| jajsmcfg#4 | -- | -- | -- | -- | -- | -- | -- | -- | -- | -- | -- |
| jplajs2_setup_cluster# 3 (UNIX only) | -- | -- | -- | -- | -- | -- | -- | -- | -- | -- | -- |
| jplexec (Windows only) | -- | -- | -- | -- | -- | -- | -- | -- | -- | -- | -- |
| jplexit (Windows only) | -- | -- | -- | -- | -- | -- | -- | -- | -- | -- | -- |
| jpoagoec | -- | -- | -- | -- | -- | -- | -- | -- | -- | -- | -- |
| jpoagtjobshow | Y | -- | -- | -- | -- | -- | -- | -- | -- | -- | -- |
| jpomailprof (Windows only) | -- | -- | -- | -- | -- | -- | -- | -- | -- | -- | -- |
| jpomailrecv#3 (UNIX only) | Y | -- | -- | -- | -- | -- | -- | -- | -- | -- | -- |
| jpomanevreset#11 | Y | -- | -- | -- | -- | -- | -- | -- | -- | -- | -- |
| jpomanevshow | Y | -- | -- | -- | -- | -- | -- | -- | -- | -- | -- |
| jpomanjobshow | Y | -- | -- | -- | -- | -- | -- | -- | -- | -- | -- |
| jpgagtadd#4 | Y | -- | -- | -- | -- | -- | -- | -- | -- | -- | -- |
| jpgagtalt#4 | Y | -- | -- | -- | -- | -- | -- | -- | -- | -- | -- |
| jpgagtdel#4 | Y | -- | -- | -- | -- | -- | -- | -- | -- | -- | -- |
| jpgagtlink#4 | Y | -- | -- | -- | -- | -- | -- | -- | -- | -- | -- |
| jpgagtshow#4 | Y | -- | -- | -- | -- | -- | -- | -- | -- | -- | -- |

| Command name | JP1/AJS3#1 | Scheduler service | HP NNM#2 | Qa | Qf | CHm | CHa | At | Atm | Scm | Sca |
|-------------------|------------|-------------------|----------|----|----|-----|-----|----|-----|-----|-----|
| jpgagtunlink#4 | Y | -- | -- | -- | -- | -- | -- | -- | -- | -- | -- |
| jpgdbcond | -- | -- | -- | -- | -- | -- | -- | -- | -- | -- | -- |
| jpgendjobshow#4 | Y | -- | -- | -- | -- | -- | -- | -- | -- | -- | -- |
| jpgexport#4 | -- | -- | -- | -- | -- | -- | -- | -- | -- | -- | -- |
| jpgimport#4 | -- | -- | -- | -- | -- | -- | -- | -- | -- | -- | -- |
| jpgjobalt#4 | Y | -- | -- | -- | -- | -- | -- | -- | -- | -- | -- |
| jpgjobcan#4 | Y | -- | -- | -- | -- | -- | -- | -- | -- | -- | -- |
| jpgjobdel#4 | Y | -- | -- | -- | -- | -- | -- | -- | -- | -- | -- |
| jpgjobget#4 | Y | -- | -- | -- | -- | -- | -- | -- | -- | -- | -- |
| jpgjobmove#4 | Y | -- | -- | -- | -- | -- | -- | -- | -- | -- | -- |
| jpgjobshow#4 | Y | -- | -- | -- | -- | -- | -- | -- | -- | -- | -- |
| jpgjobsub#4 | Y | -- | -- | -- | -- | -- | -- | -- | -- | -- | -- |
| jpgqueadd#4 | Y | -- | -- | -- | -- | -- | -- | -- | -- | -- | -- |
| jpgquealt#4 | Y | -- | -- | -- | -- | -- | -- | -- | -- | -- | -- |
| jpgqueclose#4 | Y | -- | -- | -- | -- | -- | -- | -- | -- | -- | -- |
| jpgquedel#4 | Y | -- | -- | -- | -- | -- | -- | -- | -- | -- | -- |
| jpgqueopen#4 | Y | -- | -- | -- | -- | -- | -- | -- | -- | -- | -- |
| jpgregguestuser#3 | Y | -- | -- | -- | -- | -- | -- | -- | -- | -- | -- |
| jpgquestow#4 | Y | -- | -- | -- | -- | -- | -- | -- | -- | -- | -- |
| jpgreguser#3 | -- | -- | -- | -- | -- | -- | -- | -- | -- | -- | -- |
| jpgresadd#4 | Y | -- | -- | -- | -- | -- | -- | -- | -- | -- | -- |
| jpgresdel#4 | Y | -- | -- | -- | -- | -- | -- | -- | -- | -- | -- |
| jpgresshow#4 | Y | -- | -- | -- | -- | -- | -- | -- | -- | -- | -- |

Legend:

- Qa: Queueless agent service
- Qf: Queueless file transfer service
- CHm: JP1/AJS3 Check Manager
- CHa: JP1/AJS3 Check Agent
- At: JP1/AJS3 Autonomous Agent service
- Atm: JP1/AJS3 Autonomous Agent Messenger service
- Scm: JP1/AJS3 System Control Manager service
- Sca: JP1/AJS3 System Control Agent service
- Y: Must be started

--: May not be started

#1

In a cluster configuration, you must have the JP1/AJS3 logical host started instead of starting JP1/AJS3.

#2

For further details about the service name for HP NNM, see the documentation for HP NNM.

#3

For details about the commands, see *2. Commands Used during Setup*.

#4

For details about the commands, see *4. Commands Used for Special Operation*.

#5

You must have the embedded database service started.

#6

You must have the scheduler service started in the following cases:

- When you switch scheduler log files on a scheduler service basis
- When you suppress jobnet or job execution or cancel the suppression

You do not need to have the scheduler service started when you switch scheduler log files on a host basis.

#7

You must have the JP1/AJS3 service started if you specify a job group.

#8

You must have the scheduler service started if you perform release entry or cancellation.

#9

Either the JP1/AJS3 service or queueless agent service must be running.

#10

You must have the JP1/AJS3 service started if you separately start any of the processes that make up the JP1/AJS3 functionality.

#11

You can execute the `jpomanevreset` command only when the JP1/AJS3 host service is active and the target scheduler service has stopped. An error occurs if all JP1/AJS3 services are stopped or if the scheduler service is active when you execute this command.

2

Commands Used during Setup

This chapter describes the commands that are used to set up JP1/AJS3.

ajs_adapter_setup

Format

```
ajs_adapter_setup  
  {-i|-u}
```

Description

Creates an adapter command configuration file (Adapter_HITACHI_JP1_AJS2.conf) or deletes the existing adapter command configuration file that is used for linkage with JP1/IM.

Execution privileges

In Windows: Administrators privileges

In UNIX: Superuser privileges

Arguments

-i

Creates an adapter command configuration file at the destination where the adapter command configuration file will be stored. Setting this option enables JP1/IM to collect JP1/AJS3 definition information.

-u

Deletes the adapter command configuration file from the destination where the adapter command configuration file is stored.

Destination where the adapter command configuration file is stored

In Windows:

JP1/Base-installation-folder\plugin\conf\

In UNIX:

/opt/jplbase/plugin/conf/

Notes

- If JP1/Base is not installed (if the path to the destination for creating an adapter command configuration file does not exist), the system does not create an adapter command configuration file even if you specify the **-i** option.
- If you omit all the options for this command, the system assumes **-i**.
- To link with JP1/IM in a cluster system to collect JP1/AJS3 definition information, execute the `ajs_adapter_setup` command on both the primary node and the secondary node.

Return values

| | |
|---------------------|--------------|
| 0 | Normal end |
| Values other than 0 | Abnormal end |

ajsatsetup

Format

```
ajsatsetup  
{-a [-p broadcast-agent-IP-address-or-host-name] | -m | -g | -u}
```

Format 1 (setup on a relay agent)

```
ajsatsetup -m
```

Format 2 (setup on a destination agent)

```
ajsatsetup -a
```

Format 3 (setup on a broadcast agent)

```
ajsatsetup -g
```

Format 4 (setup on a broadcast destination agent)

```
ajsatsetup -a -p broadcast-agent-IP-address-or-host-name
```

Format 5 (cancellation of all functions that are set up)

```
ajsatsetup -u
```

Description

Performs setup or unsetup of the execution environment for flexible jobs. In addition, sets up the broadcast execution function. Note that this command cannot be used for JP1/AJS3 - Agent Minimal Edition. The following shows the information set by this command.

Registering services

Registers the following services:

| Service name to be registered | -m option | -a option (including the -p option) | -g option |
|---|-----------|--|-----------|
| JP1/AJS3 Autonomous Agent service | -- | Y | Y |
| JP1/AJS3 Autonomous Agent Messenger service | Y | Y | Y |

Setting the communication port

Registers the following communication ports in the `services` file:

| Communication port (service name: port number/protocol) | -m option | -a option | | -g option |
|---|-----------|----------------------------|-----------|-----------|
| | | No other options specified | -p option | |
| jp1ajs2atmsg: 22251/tcp | Y | Y | Y | Y |

| Communication port (service name: port number/protocol) | -m option | -a option | | -g option |
|---|-----------|----------------------------|-----------|-----------|
| | | No other options specified | -p option | |
| jp1ajs2atmsg: 22251/udp | -- | -- | Y | Y |

Legend:

Y: This option is set.

--: This option is not set.

Execution privileges

In Windows: Administrators privileges

In UNIX: Superuser privileges

Storage directory

In Windows:

JP1/AJS3 - Manager -installation-folder\bin

JP1/AJS3 - Agent -installation-folder\bin

In UNIX:

/opt/jp1ajs2/bin/

Arguments

-m

Sets up the function of the requester of the flexible job.

If you do not use a relay agent, specify this option on JP1/AJS3 - Manager. If you use a relay agent, specify this option on the relay agent.

This option cannot be specified together with the **-a**, **-u**, or **-g** option.

-a

Sets up the function of the request target of the flexible job.

Specify this option on the destination agent.

This option cannot be specified together with the **-m**, **-u**, or **-g** option.

-p *broadcast-agent-IP-address-or-host-name*

Sets up the host as a broadcast-execution destination agent.

Specify the IP address or host name of the broadcast agent to which you want to send a heartbeat. You can specify a character string of 1 to 128 bytes.

You can specify this option only if the **-a** option is specified.

If you specify an unresolvable host name or incorrectly formatted IP address, this command terminates abnormally with the KAVS8143-E or KAVS8114-E message.

-u

Cancels setup of the execution environment for flexible jobs, including the functions of broadcast execution. Also, deletes the JP1/AJS3 Autonomous Agent service and the JP1/AJS3 Autonomous Agent Messenger service. However, registration of the communication port (jplajs2atmsg: 22251) in the `services` file is not deleted.

This option cannot be specified together with the `-m`, `-a`, or `-g` option.

-g

Sets up the agent as a broadcast agent.

This option cannot be specified together with the `-m`, `-a`, or `-u` option.

Notes

- Execute this command when neither the JP1/AJS3 Autonomous Agent service nor JP1/AJS3 Autonomous Agent Messenger service is running. If either of these services, or both, is running, the command might terminate abnormally.
- Do not execute this command from multiple different terminals at the same time.
- If this command is executed with the options below specified while internal processing of the broadcast execution function is executing in the background, command processing is suspended until the background internal processing is completed. Therefore, processing might require a long time.
 - `-a -p` option
 - `-g` option
 - `-u` option
- You cannot specify `localhost` when using the `-a -p` option. If the local host is the broadcast agent, specify the IP address or host name of the local host for the `-a -p` option.

Return values

| | |
|----------------------|--------------|
| 0 | Normal end |
| A value other than 0 | Abnormal end |

ajschksetup

Format

For JP1/AJS3 - Manager:

```
ajschksetup
  [{ [-m] [-a] | [-u] }]
```

For JP1/AJS3 - Agent:

```
ajschksetup
  [{ [-a] | [-u] }]
```

Description

Sets the environment for running the definition pre-check function. The following is the information to be set by this command.

Registering services

The following services are registered for running the definition pre-check function:

| Service name to be registered | JP1/AJS3 - Manager | JP1/AJS3 - Agent |
|--------------------------------|--------------------|------------------|
| JP1/AJS3 Check Manager service | Y | -- |
| JP1/AJS3 Check Agent service | Y | Y |

Setting the communication port

The following communication ports are registered in the services file for running the definition pre-check function:

| Communication port (service name: port number) | JP1/AJS3 - Manager | JP1/AJS3 - Agent |
|---|--------------------|------------------|
| Executing the definition pre-check function (JP1/AJS3 Check Manager: 23138) | Y | -- |
| Executing the definition pre-check function (JP1/AJS3 Check Agent: 23139) | Y | Y |

Setting the common definition information

The common definition information are set for running the definition pre-check function:

| Setting information | | JP1/AJS3 - Manager | JP1/AJS3 - Agent |
|-----------------------------|---------------------------------|--------------------|------------------|
| Definition key | Environment setting parameter | | |
| [JP1_DEFAULT\JP1AJS2\CHECK] | "AJSCHK_CHECKFILE"=# | Y | -- |
| | "AJSCHK_LOGDIR"=# | Y | Y |
| | "AJSCHK_LOGSIZE"=dword:00001000 | Y | Y |
| | "AJSCHK_TRACELOGFILE"=# | Y | Y |
| | "AJSCHK_CHARCODE"="none" | Y | Y |

Legend:

Y: Can be set.

--: Cannot be set.

#

The value varies depending on the environment. For details about environment setting parameter, see *20.7 Setting for the JP1/AJS3 definition pre-check function* in the *JP1/Automatic Job Management System 3 Configuration Guide*.

Execution privileges

In Windows: Administrators privileges

In UNIX: Superuser privileges

Storage directory

In Windows:

JP1/AJS3 - Manager-installation-folder\bin\
JP1/AJS3 - Manager-installation-folder\bin\

JP1/AJS3 - Agent-installation-folder\bin\
JP1/AJS3 - Agent-installation-folder\bin\

In UNIX:

/opt/jp1ajs2/bin/

Arguments

-m

Sets up the definition pre-check function (JP1/AJS3 Check Manager service).

This argument can be set only with JP1/AJS3 - Manager. It cannot be specified with JP1/AJS3 - Agent.

This option cannot be specified together with the -u option.

-a

Sets up the definition pre-check function (JP1/AJS3 Check Agent service).

This option cannot be specified with the -u option simultaneously.

-u

Deletes the settings for the definition pre-check function.

In Windows, this argument deletes the JP1/AJS3 Check Manager service and the JP1/AJS3 Check Agent service from the service list in the Administrative Tools.

This option cannot be specified together with the -m or -a option.

Notes

- Before you delete a service after specifying the -u option in the Windows environment, make sure that the JP1/AJS3 Check Manager service and the JP1/AJS3 Check Agent service have been stopped.
- When you omit the -m, -a, or -u option for setting types, the following option is assumed:
 - For JP1/AJS3 - Manager: -m, -a
 - For JP1/AJS3 - Agent: -a

- On a Windows host, before you execute a command that must be executed by a user with administrator privileges, make sure that you open the Command Prompt window as an administrator. If the UAC function is disabled, you do not need to open the Command Prompt window as an administrator.

Return values

| | |
|----------------------|--------------|
| 0 | Normal end |
| A value other than 0 | Abnormal end |

Example

With JP1/AJS3 - Manager, set up the JP1/AJS3 Check Manager service and the JP1/AJS3 Check Agent service.

```
ajschksetup -m -a
```

ajscnvdlexport

Format

```
ajscnvdlexport
  [-mh logical-host-name]
  -F scheduler-service-name
  -b database-backup-file-storage-directory
```

Description

The `ajscnvdlexport` command exports the data of the specified scheduler service from the scheduler database of JP1/AJS2 whose version is 8 or earlier to a file in binary format.

You can execute this command only when you can access the database for the scheduler service in JP1/AJS2 whose version is 8 or earlier.

Execution privileges

In Windows: Administrators privileges

In UNIX: Superuser privileges

Storage directory

In Windows:

`JP1/AJS3 - Manager-installation-folder\tools\`

In UNIX:

`/opt/jp1ajs2/tools/`

Arguments

-mh *logical-host-name*

Specify the name of a logical host. You can specify a character string of 1 to 255 bytes.

If environment variable `JP1_HOSTNAME` is set when this option is omitted, the system assumes the logical host name specified in the environment variable. If the `JP1_HOSTNAME` environment variable is not specified, `JP1_DEFAULT` is assumed.

-F *scheduler-service-name*

Specify the name of the target scheduler service. You can specify a character string of 1 to 30 bytes.

-b *database-backup-file-storage-directory*

Specify the absolute path name of the directory that will store database backup files. You can specify a character string of 1 to 244 bytes.

Do not specify a non-existent directory.

When this command is executed, a backup file named *table-ID*.bk is created for each table in the following directory:

`database-backup-file-storage-directory\logical-host-name\scheduler-service-name`

Notes

- This command is used for migration from JP1/AJS2 V8 or earlier. An attempt to import the backup data to the scheduler service set up in JP1/AJS3 V9 results in an error.
- This command performs operations on the embedded database existing before migration. Therefore, if the embedded database is used as the scheduler database before migration, add the following path to the appropriate environment variable, and then execute the command.

In HP-UX:

```
SHLIB_PATH=installation-directory-for-the-embedded-database-before-migration/client/lib
```

In Solaris or Linux:

```
LD_LIBRARY_PATH=installation-directory-for-the-embedded-database-before-migration/client/lib
```

In AIX:

```
LIBPATH=installation-directory-for-the-embedded-database-before-migration/client/lib
```

If you execute the command without adding the above path, the command outputs the KAVS0990-E message, and terminates abnormally.

- If the embedded database or HiRDB is used as the scheduler service database in JP1/AJS2 whose version is 8 or earlier, make sure that the embedded database or HiRDB is started before executing the command.
For details about how to start the embedded database or HiRDB, see the applicable JP1/AJS2 or HiRDB manual.
- If you are using an embedded DB or HiRDB as the database for the scheduler service in a JP1/AJS2 V8 environment or earlier, disable the client environment definitions of the embedded DB and/or HiRDB specified in the environment where the command is executed.

Return values

| | |
|-----------------------------|--------------|
| 0 | Normal end |
| Multiple of 4 from 4 to 124 | Abnormal end |

ajscnvdbimport

Format

```
ajscnvdbimport
  [-mh logical-host-name]
  -F scheduler-service-name
  -b database-backup-file-storage-directory
```

Description

The `ajscnvdbimport` command imports the database backup data created by the `ajscnvdbexport` command to the specified scheduler database.

If the specified scheduler service already has data, the command deletes the existing data, and then imports the backup data.

You can execute this command only when you can access the scheduler service database.

Execution privileges

In Windows: Administrators privileges

In UNIX: Superuser privileges

Storage directory

In Windows:

`JP1/AJS3 - Manager-installation-folder\tools\`

In UNIX:

`/opt/jp1ajs2/tools/`

Arguments

-mh *logical-host-name*

Specify a logical host name. You can specify a character string of 1 to 255 bytes.

If this option is omitted, the value of the `JP1_HOSTNAME` environment variable is assumed. If the environment variable is not set, `JP1_DEFAULT` is assumed.

-F *scheduler-service-name*

Specify the name of the scheduler service for which you want to import the backup data to the database. You can specify a character string of 1 to 30 bytes.

-b *database-backup-file-storage-directory*

Specify the absolute path name of the directory that contains the database backup file. You can specify a character string of 1 to 234 bytes.

The value you specify in this option is the value that was specified in the `-b` option when the `ajscnvdbexport` command was executed.

Note

This command is used for migration from JP1/AJS2 V8 or earlier. An attempt to import the backup data to the scheduler service set up in JP1/AJS3 V9 results in an error.

Return values

| | |
|-----------------------------|--------------|
| 0 | Normal end |
| Multiple of 4 from 4 to 124 | Abnormal end |

ajsembdbbuild

Format

```
ajsembdbbuild
  [-_l|-m|-s]
  {
    {-d data-area-directory
      [,system-area-directory-1
        [,system-area-directory-2]]
    } [-lh logical-host-name] |
    {{-r|-f}
      {-d data-area-directory
        [,system-area-directory-1
          [,system-area-directory-2]] |
      }
    -ld work-area-directory
    -mh logical-host-name
    -eh primary-node-physical-host-name
  }
  [-p port-number]
  [-i embedded-database-practical-directory]
  [-bs -bl unload-log-file-creation-directory |
  -br -bl unload-log-file-creation-directory ]
  [-rs]
  [-c]
  [-lc character-code-set-type]
  [-id setup-identifier]
  [-ext_db]
  [-ext_log]
  [-conf embedded-database-settings-file-name]
  [-b]
```

Format 1 (standard setup on a physical host)

```
ajsembdbbuild
  [-_l|-m|-s]
  -d data-area-directory
    [,system-area-directory-1]
  [-lh logical-host-name] |
  [-p port-number]
  [-i embedded-database-practical-directory]
  [-rs]
  [-c]
  [-lc character-code-set-type]
  [-id setup-identifier]
  [-ext_db]
  [-ext_log]
  [-conf embedded-database-settings-file-name]
```

Format 2 (setup for creating a backup and obtaining an unload log file periodically on a physical host)

```
ajsembdbbuild
  [-_l|-m|-s]
  -d data-area-directory
```

```

    ,system-area-directory-1
      [,system-area-directory-2]
[-lh logical-host-name] |
[-p port-number]
[-i embedded-database-practical-directory]
{-bs -bl unload-log-file-creation-directory|
-br -bl unload-log-file-creation-directory}
[-rs]
[-c]
[-lc character-code-set-type]
[-id setup-identifier]
[-ext_db]
[-ext_log]
[-conf embedded-database-settings-file-name]

```

Format 3 (standard setup on a logical host)

```

ajsembdbbbuild
  [-_l|-m|-s]
  {-r|-f}
-d data-area-directory
  [,system-area-directory-1]
-ld work-area-directory
-mh logical-host-name
-eh primary-node-physical-host-name
[-p port-number]
-i embedded-database-practical-directory
[-rs]
[-c]
[-lc character-code-set-type]
[-id setup-identifier]
[-ext_db]
[-ext_log]
[-conf embedded-database-settings-file-name]

```

Format 4 (setup for creating a backup and obtaining an unload log file periodically on a logical host)

```

ajsembdbbbuild
  [-_l|-m|-s]
  {-r|-f}
-d data-area-directory
  ,system-area-directory-1
  [,system-area-directory-2]
-ld work-area-directory
-mh logical-host-name
-eh primary-node-physical-host-name
[-p port-number]
-i embedded-database-practical-directory
{-bs -bl unload-log-file-creation-directory |
-br -bl unload-log-file-creation-directory}
[-rs]
[-c]
[-lc character-code-set-type]
[-id setup-identifier]
[-ext_db]

```

```
[-ext_log]
[-conf embedded-database-settings-file-name]
```

Format 5 (setup for configuring an embedded database on a secondary node by using the embedded database settings file created on the primary node)

```
ajsembddbbuild
  -conf embedded-database-settings-file-name
```

Format 6 (setup for enabling the backup enhancement function on the physical host)

```
ajsembddbbuild
  [-l|-m|-s]
  -d data-area-directory
    [,system-area-directory-1]
  [-p port-number]
  [-i embedded-database-practical-directory]
  [-id setup-identifier]
  [-ext_db]
  [-ext_log]
  [-conf embedded-database-settings-file-name]
  -b
```

Format 7 (setup for enabling the backup enhancement function on the logical host)

```
ajsembddbbuild
  [-l|-m|-s]
  -d data-area-directory
    [,system-area-directory-1]
  -ld work-area-directory
  -mh logical-host-name
  -eh primary-node-physical-host-name
  [-p port-number]
  [-i embedded-database-practical-directory]
  [-id setup-identifier]
  [-ext_db]
  [-ext_log]
  [-conf embedded-database-settings-file-name]
  -b
```

Description

The `ajsembddbbuild` command creates the embedded database environment for JP1/AJS3, and starts the embedded database in the environment.

When you create the environment for cluster operation, execute this command on both the executing host and the standby host.

You must enable the IP address to which the name of the disk to be used and the applicable host name resolve. Note that when you execute the command on the standby host, you do not need to enable this IP address.

In Windows, the JP1/AJS3 Database `_JFn` (*n* indicates a character from 0 to 9 or from A to Z) service of the embedded database to be configured must be in running status.

Execution privileges

In Windows: Administrators privileges

In UNIX: Superuser privileges

Storage directory

In Windows:

```
JP1/AJS3 - Manager-installation-folder\tools\
```

In UNIX:

```
/opt/jp1ajs2/tools/
```

Arguments

-l | -m | -s

Selects one of the following three database models.

- **-l**

Selects the large-scale system model, as shown below.

When the value of the `DEFLENTYPE` environment settings parameter is `byte`:

- Total number of units: About 48,000 to 240,000
- Number of jobs executed per day and total number of jobnets: 30,000 to 120,000
- Approximate disk capacity: 20,700 MB[#]

When the value of the `DEFLENTYPE` environment settings parameter is `sjis`:

- Total number of units: About 38,400 to 192,000
- Number of jobs executed per day and total number of jobnets: 24,000 to 96,000
- Approximate disk capacity: 20,700 MB[#]

- **-m**

Selects the medium-scale system model, as shown below.

When the value of the `DEFLENTYPE` environment settings parameter is `byte`:

- Total number of units: About 5,000 to 48,000
- Number of jobs executed per day and total number of jobnets: 5,000 to 30,000
- Approximate disk capacity: 4,200 MB[#]

When the value of the `DEFLENTYPE` environment settings parameter is `sjis`:

- Total number of units: About 4,000 to 38,400
- Number of jobs executed per day and total number of jobnets: 4,000 to 24,000
- Approximate disk capacity: 4,200 MB[#]

- **-s**

Selects the small-scale system model, as shown below.

When the value of the `DEFLENTYPE` environment settings parameter is `byte`:

- Total number of units: Up to about 5,000
- Number of jobs executed per day and total number of jobnets: Up to 5,000

- Approximate disk capacity: 520 MB[#]

When the value of the `DEFLENTYPE` environment settings parameter is `sjis`:

- Total number of units: Up to about 4,000
- Number of jobs executed per day and total number of jobnets: Up to 4,000
- Approximate disk capacity: 520 MB[#]

The default is `-l` (large-scale system).

#:

To enable the backup enhancement function, add approximately 500 megabytes of disk space.

-d *data-area-directory* [, *system-area-directory-1* [, *system-area-directory-2*]]

Specify the names of the directories to be used as the data area and system area of the embedded database.

- *data-area-directory*

Specifies the directory containing the data area of the embedded database. The data area of the embedded database is allocated in this directory and holds the body of the JP1/AJS3 scheduler database.

If you do not specify *system-area-directory-1* described later, the directory specified here also contains the system area of the embedded database for storing system files.

- *system-area-directory-1*

If you want to use the system log (specify the `-bs` option), you must also specify *system-area-directory-1*. The system area of the embedded database is allocated in this directory for the storage of system files.

- *system-area-directory-2*

If you want to use the system log and duplex the system files (specify the `-br` option), you must also specify *system-area-directory-2*. Specifying the `-br` option creates duplicate system files.

Hitachi recommends that you place each of the above directories on a different volume to improve reliability.

When you create an environment for cluster operation (`-r` or `-f` option), specify the directories on the shared disk.

The name of each directory must be an absolute path of 50 bytes or less. If a name contains space characters, enclose the entire path in double quotation marks (" ").

When you specify multiple directories, enclose the entire value of the `-d` option in double quotation marks (" "). Do not enclose each separate directory name in double quotation marks (" ").

Do not specify any directory used by another embedded database.

-lh *logical-host-name*

You do not need to specify this option.

When you operate a logical host in a non-cluster environment, specify the `-mh`, `-eh`, `-ld`, and `-r` options.

-r

Specify this option when you configure the environment of the executing host in a cluster configuration or of the logical host in a non-cluster configuration. At the same time, you also need to specify a logical host name (`-mh` option) and the work area directory (`-ld` option).

The shared disk for storing the data area and the system area of the embedded database must be mounted on the executing host. In addition, the target logical host must be available for access.

-f

Specify this option to create the environment for the standby host in a cluster configuration. You also need to specify a logical host name (`-mh` option) and the embedded database work area directory (`-ld` option) at the same time.

When you specify this option, only the embedded database is set. The data area is not created and the embedded database is not started. However, make sure that the specification of the data area and the system area of the embedded database (`-d` option) is the same as the environment for the executing host.

-ld *work-area-directory*

Specify this option when you create an environment for logical host (`-r` or `-f` option). As the work area to be used by the embedded database, specify the name of a directory on the physical host. Do not specify a directory on the shared disk.

The name of the directory must be an absolute path of 50 bytes or less. If the name contains space characters, enclose the entire path in double quotation marks (" ").

Secure 40 MB of free space in the file system of the directory to be specified.

Do not specify any directory used by another embedded database.

-mh *logical-host-name*

Specify this option when you create an environment for logical host (`-r` or `-f` option). Specify a logical host name. You can specify a character string of 1 to 32 bytes.

-eh *primary-node-physical-host-name*

Specify this option when you create an environment for logical host (`-r` or `-f` option). Specify the host name (host name output by using the `hostname` command) that is recognized as the TCP/IP host name by the operating system on the executing host.

Note that you must specify the physical host name of the primary node for this option even when you are creating the environment for the standby host (`-f` option). You can specify a character string of 1 to 63 bytes.

-p *port-number*

Specify the port number to be used for the embedded database. You can specify a number from 5001 to 65535.

You must specify a port number that is not being used in the system. If other JP1 products are using the embedded database, make sure that you do not specify a port number that these products use.

Note that in Windows, if you specify a port number that has already been used, the following problems might occur:

- JP1/AJS3 terminates abnormally or cannot operate normally.
- The program that uses the duplicate port number terminates abnormally or cannot operate normally.

If you omit this option, the system assumes 22220.

-i *embedded-database-practical-directory*

Specify the name of the directory to be used as the embedded database practical directory.

If you are not sure about the name of the embedded database installation directory, execute the following command to check the name:

```
ajsembdbidlist -v
```

For details on the `ajsembdbidlist` command, see *ajsembdbidlist* in *2. Commands Used during Setup*.

Use absolute paths to specify the names of directories. If the name of a directory contains space characters, enclose the entire path in double quotation marks (" ").

When you create an environment for cluster operation (`-r` or `-f` option), do not specify a directory on the shared disk.

You can omit this option for UNIX. If you omit the option, the system assumes `/opt/jplajs2/embdb/_JF0`.

Do not specify any directory used by another embedded database.

-bs

Specify this option if you use the system log and do not duplex the system files.

If you specify this option without specifying the `-bl` option, an error occurs.

-br

Specify this option if you use the system log and duplex the system files.

If you specify this option without specifying the `-bl` option, an error occurs.

-bl *unload-log-file-creation-directory*

Specify a directory in which the unload log file will be created. If you do not specify the `-bs` or `-br` option together with the `-bl` option, an error occurs.

The command results in an error if you specify the `-bl` option with the `-b` option.

The directory name you can specify in this option must be an absolute path name that is no more than 50 bytes. If the name contains space characters, enclose the entire path in double quotation marks (" ").

Do not specify any directory used by another embedded database.

For details on how to acquire the unload log file of the embedded database, see *F.1(1) Restoring the scheduler database from unload log files* in the *JP1/Automatic Job Management System 3 System Design (Configuration) Guide*.

-rs

You do not need to specify this option. If you specify it, processing ends without configuring the embedded database.

-c

Specify this option when you have upgraded JP1/AJS3. This option updates the configuration files used by the embedded database to the latest ones. Do not specify this option for a new installation, or if you do not want to update the configuration files.

Note that if you update configuration files, they are overwritten.

If JP1/AJS3 is upgraded from JP1/AJS2 Version 8 or earlier, you must specify this option when you execute the command for the first time after the upgrading.

-lc *character-code-set-type* (UNIX only)

This option no longer needs to be specified.

The character code set specified for this option is ignored, and JP1/AJS3 - Manager automatically sets the character code set.

-id *setup-identifier*

Use four characters, `_JFn` (*n* is 0 to 9 or A to Z), to specify the setup identifier for identifying the embedded database.

Make sure that you specify the setup identifier specified for the `-id` option of the `ajsembdbidlist` command.

If you omit this option, the system assumes `_JF0`. This option is ignored when you specify the `-rs` options.

To check the registered setup identifiers and embedded database practical directories, execute the `ajsembdbidlist` command.

For details on the `ajsembdbidlist` command, see [ajsembdbidlist](#) in *2. Commands Used during Setup*.

-ext_db

Specify this option if you want to use the database area auto-increment function.

To check whether the auto-increment function is used, execute the following commands:

Data area:

```
pddbst -k phys -f -r AJS2DATA
pddbst -k phys -f -r AJS2DATA2#
```

Index area:

```
pddbst -k phys -f -r AJS2INDX
pddbst -k phys -f -r AJS2INDX2#
```

#:

This check is unnecessary if the backup enhancement function is not used.

The `Auto Extend Use` value indicates whether the function is used:

USE: The auto-increment function is used.

NOUSE: The auto-increment function is not used.

Note that before you execute the `pddbst` command from a command prompt, you need to set environment variables from the same command prompt. For details about the environment variables you must set, see the table that describes them in *9.2.3(2) Using a script to reorganize the database* in the *JP1/Automatic Job Management System 3 Administration Guide*.

-ext_log

Specify this option if you want to use the system log auto-increment function.

To check whether the auto-increment function is enabled, use the following command:

```
ajsembdbstatus -l -id embedded-database-setup-ID
```

For details on the `ajsembdbstatus` command, see [ajsembdbstatus](#) in *3. Commands Used for Normal Operations*.

-conf *embedded-database-settings-file-name*

Specify the embedded database settings file. An embedded database is configured with the same settings as the embedded database that was configured when the specified embedded database settings file was output.

If this option is specified together with other options, the options specified in the embedded database settings file take precedence.

When this option is specified, the `-d`, `-ld`, `-mh`, `-eh`, `-r`, `-f` and `-b` options can be omitted.

If the embedded database settings file that was output when the logical host was built is specified, but the `-r` or `-f` option is omitted, the `-f` option is assumed.

If the contents of the embedded database settings file are invalid, the KAVS2130-E message is output, and the command ends abnormally.

To use an embedded database settings file that was output in an environment using a different character encoding, convert the character codes.

If you specify this option, the directory structure must match the environment of the embedded database that was configured when the embedded database settings file specified as the argument was output. Accordingly, create beforehand the directories specified for the `-d`, `-ld`, and `-bl` options of the `ajsembdbbuild` command by which the environment of the embedded database was configured when the embedded database settings file was output.

The embedded database settings file is output to the following location.

In Windows:

```
embedded-database-practical-directory\conf\ajsdbst\ajsembdb-setup-identifier.conf
```

In UNIX:

```
embedded-database-practical-director/conf/ajsdbst/ajsembdb-setup-identifier.conf
```

-b

Specify if you build an embedded DB where the backup enhancement function is enabled. If this specification is omitted, an embedded DB is built where the backup enhancement function is disabled.

The command results in an error if you specify the `-b` option with the `-bl` option.

If you specified this option, also specify the `-b` option in the `ajsembdbsetup` command. For details about the `ajsembdbsetup` command, see [ajsembdbsetup in 2. Commands Used during Setup](#).

Notes

- When you re-create the embedded database environment, execute the `ajsembdbunset` command to initialize the information about the embedded database environment and then execute the `ajsembdbbuild` command. To delete the embedded database environment, execute the `ajsembdbunset` command as well.

Note that when you execute the `ajsembdbunset` command, the information about the embedded database environment is forcibly initialized even if the scheduler service is accessing the embedded database. Use caution when you execute the `ajsembdbunset` command.

For details on the `ajsembdbunset` command, see [ajsembdbunset in 2. Commands Used during Setup](#).

- The `ajsembdbbuild` command is incorporated into a script. For this reason, specifying an excessively long character string or an invalid character string or value may result in an unexpected error. In the options, therefore, specify the character strings and numeric values defined in DBMS and JP1/AJS3.

- When executing the `ajsembdbbuild` command, you must set the maximum file size available in the OS file system at a value greater than 2 gigabytes, or set it at infinity.
For AIX, in particular, note that the file size limit is set at a default of 1 gigabyte.
- Even if the directory name specified in the `-bl` option is incorrect, the embedded database system may complete the startup process. When you specify the `-bl` option, see the Windows event log or syslog to check if an error message for the embedded database KFPS01150-E has been output.
- Do not use multi-byte characters or special symbols for path names such as the path name of the embedded database practical directory.
- If the `ajsembdbbuild` command outputs either of the following messages and terminates, execute the `ajsembdbunset` command with the `-i` option specified to delete the environment, and then re-execute the `ajsembdbbuild` command:
 - KAVS2124-E Failed in construction of EmbedDB server.
 - KAVS2122-E A temporary file already exists.
- Do not execute `ajsembdbbuild` command repeatedly in quick succession. If you do so, the following problems might occur:
 - The message output is invalid. For example, an invalid message is output or a message that should be output is not output.
 - The `ajsembdbbuild` command results in an error.
 - The configuration definition information becomes invalid, disabling further operation of JP1/AJS3.
- Before you execute this command, register in the `hosts` file or DNS the name of the host on which you are creating the embedded database environment. In a cluster system, register both the physical and logical host names of the primary node.
- If you register the name of the host on which the embedded database environment has been set up in the `jp1hosts` or `jp1hosts2` definition file, that name does not become effective as the host name used for the embedded database.
- Do not use aliases as the name of the host on which the embedded database environment has been set up.
- For hosts on which the embedded database environment has been set up, specify a physical host name by using 1 to 63 bytes, and specify a logical host name by using 1 to 32 bytes.

Actions to be taken if an error occurs

If a problem occurs during execution of the `ajsembdbbuild` command, the return code, error message, and termination message are output in this order to the standard output and standard error output. Troubleshoot the problem according to the following table, and then re-execute the command.

| Code | Message ID | Cause | Action taken |
|------|------------|--|--|
| 1 | KFPX29601 | The <code>-d</code> option is specified incorrectly. | Revise the arguments specified in <code>-d</code> option. |
| 3 | KFPX29603 | The specified directory is not an embedded database practical directory. | Specify an embedded database practical directory in the <code>-i</code> option. |
| 4 | KFPX29604 | No embedded database practical directory is specified. | |
| 5 | KFPX29605 | A port number is duplicated. | Specify a port number in the <code>-p</code> option so that it does not duplicate another port number. |

| Code | Message ID | Cause | Action taken |
|------|------------------------|--|--|
| 6 | KFPX29606 | System common definition is incorrect. | This error occurs when you modify setup files such as the system common definition manually. Correct the cause of the error. If the length of the specified absolute path name exceeds 50 bytes, specify an absolute path name that is no more than 50 bytes. |
| 7 | KFPX29607 | The file does not exist. | Review the <code>ajsembddbbuild</code> command execution environment. Revise the arguments specified in <code>-ld</code> option. |
| 8 | KFPX29608 | The file could not be opened. | |
| 9 | KFPX29609 | The file could not be read. | |
| 10 | KFPX29610 | A file could not be created. | |
| 11 | KFPX29611 | A directory could not be created. | Review the arguments specified in <code>-d</code> , <code>-b1</code> , and <code>-ld</code> options. If the AJS administrator is executing the command, make sure the AJS administrator has execution privileges. |
| 12 | KFPX29612 | The table and system area is insufficient. | Review the <code>ajsembddbbuild</code> command execution environment. Revise the arguments specified in <code>-ld</code> option. |
| 13 | KFPX29613 | | |
| 14 | KFPX29614 | | |
| 15 | KFPX29615 | | |
| 16 | KFPX29616 | An error occurred during the creation of a table and system area. | Review the <code>ajsembddbbuild</code> command execution environment. Revise the arguments specified in <code>-b1</code> option. If the maximum file size available for the OS file system has a setting equal to or less than 2 gigabytes, you must change the setting to a value greater than 2 gigabytes, or set it at infinity. |
| 17 | KFPX29617 | An error occurred during system area initialization. | Review the <code>ajsembddbbuild</code> command execution environment. Revise the arguments specified in <code>-ld</code> option. |
| 18 | KFPX29618 | An error occurred during embedded database start or table area initialization. | Review the command execution environment. Confirm that communication can be established with the IP address that was resolved from the specified host name. Revise the argument specified in <code>-b1</code> option. Required resources for the embedded database are insufficient. For details, see <i>3.2.5 Estimating the values for kernel parameters</i> in the <i>JP1/Automatic Job Management System 3 System Design (Configuration) Guide</i> . |
| 19 | KFPX29619 | An internal error occurred in the embedded database. | Back up the embedded database practical directory and contact the system administrator. |
| 20 | KFPX29620 | An error occurred during temporary file creation. | Review the <code>ajsembddbbuild</code> command execution environment. Revise the arguments specified in <code>-b1</code> option. |
| 21 | KFPX29621 | The file format is incorrect. | This error occurs if you modify setup files such as the system common definition manually. Correct the cause of the error. |
| 22 | KFPX29622 | System area specification is incorrect. | |
| 23 | KFPX29623 | An internal error in the embedded database. | Save the directory specified as the embedded database practical directory, and contact the system administrator. |
| 24 | KFPX29624 KFPS00031 | The embedded database environment has been created. | Execute the <code>ajsembdbunset</code> command to delete the embedded database environment, and then perform setup. |
| 25 | KFPX29625 | Insufficient memory. | Allocate sufficient memory and then again set up the environment. |
| 26 | KFPX29626 | An internal error occurred in the embedded database. | Back up the embedded database practical directory, and then contact the system administrator. |
| 27 | KFPX29627 | | |

| Code | Message ID | Cause | Action taken |
|------|---|--|---|
| -- | KFPS00031 | The embedded database environment has been created. | Execute the <code>ajsembdbunset</code> command to delete the previous embedded database environment. |
| -- | KFPS05089 | The directory specified in the <code>-i</code> option does not exist. | Specify the embedded database practical directory. |
| -- | Bad directory specified in <code>-i</code> option | The embedded database practical directory specified in <code>-i</code> option is invalid. | Specify the correct embedded database practical directory in <code>-i</code> option. |
| -- | There is an error in the specification of the setup identifier. | The specified setup identifier is incorrect. Alternatively, the specified setup identifier is already registered. | Check the specification of the setup identifier and re-execute the script. Use four characters, <code>_JFn</code> (<i>n</i> is from 0 to 9 or from A to Z), to specify the setup identifier. Use the <code>ajsembdbidlist</code> command to check the registered setup identifiers. |
| -- | Failed to register the configuration definition. | Registering the configuration definition failed. | Execute the <code>ajsembdbunset</code> command to delete the embedded database environment. After deleting the environment, check the execution permission for the <code>ajsembdbbuild</code> command and re-execute the <code>ajsembdbbuild</code> command. |
| -- | KAVS2130-E | The embedded database settings file is incorrect. Alternatively, there is no permission to access the file specified in the <code>-conf</code> option. | Specify the file correctly and re-execute the command. If the AJS administrator is executing the command, make sure the AJS administrator has execution privileges. |

Legend:

--: No code number.

Return values

| | |
|---------------------|--------------|
| 0 | Normal end |
| Values other than 0 | Abnormal end |

ajsembdbidlist

Format

```
ajsembdbidlist  
    [-v | -a | -e]
```

Description

Displays information that is required by commands for operating on the embedded database. The information is registered in the configuration definition.

The information to be displayed is as follows:

- Association between setup identifiers and embedded database practical directories
- Association between scheduler services and embedded database practical directories
- Association between setup identifiers of the embedded database where the agent management database is stored
- The version of the embedded database
- Installation mode of the embedded database

Note that this command can be executed regardless of the operating status of JP1/AJS3 and the embedded database.

Execution privileges

In Windows: Administrators privileges

In UNIX: Superuser privileges

Storage directory

In Windows:

JP1/AJS3 - Manager-installation-folder\tools

In UNIX:

/opt/jp1ajs2/tools/

Arguments

-v

Specify this option to display the version of the embedded database.

-a

Specify this option to display the location of the embedded database where the agent management database is stored.

-e

Specify this option to check the behavior of the installed embedded database.

Example 1

The command in this example displays the following types of information registered in the configuration definition:

- Association between setup identifiers and embedded database practical directories
- Association between scheduler services and embedded database practical directories

```
ajsembdbidlist
```

Example 2

The command in this example displays the following types of information registered in the configuration definition:

- Association between setup identifiers and embedded database installation directories
- Association between setup identifiers and embedded database versions

```
ajsembdbidlist -v
```

Example 3

The command in this example displays the following types of information registered in the configuration definition:

- Association between setup identifiers and embedded database practical directories
- Association between scheduler services and embedded database practical directories
- Association between setup identifiers of the embedded database where the agent management database is stored

```
ajsembdbidlist -a
```

Example 4

The command in this example displays the following types of information registered in the configuration definition:

- Installation mode of the embedded database

```
ajsembdbidlist -e
```

Output example 1

The following output example shows that the `ajsembdbsetup` command (embedded database setup) has been completed for `_JF0` to `_JF2` on hosts `AJSROOT1`, `AJSROOT2`, and `ROOT3`, respectively. For `_JF3`, the `ajsembdbbuild` command (embedded database environment creation) has been completed.

```
(1) *** Embeddb setup-id list 20XX/04/18 08:15:00
(2)          (3)
_JF0 C:\Program Files\HITACHI\JP1AJS2\embdb\_JF0
_JF1 C:\Program Files\HITACHI\JP1AJS2\embdb\_JF1
_JF2 C:\Program Files\HITACHI\JP1AJS2\embdb\_JF2
_JF3 C:\Program Files\HITACHI\JP1AJS2\embdb\_JF3

(4) Host-Name:JP1_DEFAULT
(5)          (6)          (7)
AJSROOT1 _JF0 C:\Program Files\HITACHI\JP1AJS2\embdb\_JF0

Host-Name:LHOST1
AJSROOT2 _JF1 C:\Program Files\HITACHI\JP1AJS2\embdb\_JF1
```

```
ROOT3 _JF2 C:\Program Files\HITACHI\JP1AJS2\embdb\_JF2
(8) --
```

Explanation of output items

- (1) The title and the time that the command was executed (in *YYYY/MM/DD hh:mm:ss* format)
- (2) Setup identifiers
- (3) Embedded database practical directories
- (4) Logical host name. For a physical host, JP1_DEFAULT is output.
- (5) Scheduler service name
- (6) Setup identifiers
- (7) Embedded database practical directories
- (8) End of output

Output example 2

The following output example shows the `ajsembdbidlist` command executed with the `-v` option specified when `_JF0` and `_JF1` have been installed on a physical host and `_JF2` has been installed on the `LHOST1` logical host.

```
(1) *** Embeddb setup-id list 20XX/04/18 08:15:00

(2) Host-Name:JP1_DEFAULT
    (3)      (4)                (5)
    _JF0 08-05-/N C:\Program Files\HITACHI\JP1AJS2\embdb\_JF0
    _JF1 08-05-/N C:\Program Files\HITACHI\JP1AJS2\embdb\_JF1

    Host-Name:LHOST1
    _JF2 08-05-/N C:\Program Files\HITACHI\JP1AJS2\embdb\_JF2
(6) --
```

Explanation of output items

- (1) The title and the time that the command was executed (in *YYYY/MM/DD hh:mm:ss* format)
- (2) Logical host name. For a physical host, JP1_DEFAULT is output.
- (3) Setup identifiers
- (4) Versions of embedded databases
- (5) Installation directories for embedded databases
- (6) End of output

Output example 3

The following output example shows the `ajsembdbidlist` command executed with the `-a` option specified when the agent management database of the physical host is stored in `_JF0`, and the agent management database of the `LHOST1` logical host is stored in `_JF2`.

```

(1) *** Embeddb setup-id list 20XX/04/18 08:15:00
(2)      (3)
_JF0 C:\Program Files\HITACHI\JP1AJS2\embdb\_JF0
_JF1 C:\Program Files\HITACHI\JP1AJS2\embdb\_JF1
_JF2 C:\Program Files\HITACHI\JP1AJS2\embdb\_JF2
_JF3 C:\Program Files\HITACHI\JP1AJS2\embdb\_JF3
(4) Host-Name:JP1_DEFAULT
(5)      (6)      (7)
AJSROOT1 _JF0 C:\Program Files\HITACHI\JP1AJS2\embdb\_JF0
Host-Name:LHOST1
AJSROOT2 _JF1 C:\Program Files\HITACHI\JP1AJS2\embdb\_JF1
ROOT3 _JF2 C:\Program Files\HITACHI\JP1AJS2\embdb\_JF2
(8) Agent DB
(9) Host-Name:JP1_DEFAULT
(10)      (11)
_JF0 C:\Program Files\HITACHI\JP1AJS2\embdb\_JF0
Host-Name:LHOST1
_JF2 C:\Program Files\HITACHI\JP1AJS2\embdb\_JF2
(12) --

```

Explanation of output items

- (1) The title and the time that the command was executed (in *YYYY/MM/DD hh:mm:ss* format)
- (2) Setup identifiers
- (3) Embedded database practical directories
- (4) Logical host name. For a physical host, JP1_DEFAULT is output.
- (5) Scheduler service name
- (6) Setup identifiers
- (7) Embedded database practical directories
- (8) Start of output for the association between agent management databases
- (9) Logical host name. For a physical host, JP1_DEFAULT is output.
- (10) Setup identifier of the embedded database where the agent management database for each logical host is stored
- (11) Installation directories for embedded databases
- (12) End of output

Output example 4

The following output example shows the `ajsembdbidlist` command executed with the `-e` option specified when `_JF0` and `_JF1` have been installed on a physical host and `_JF2` and `_JF3` have been installed on the `LHOST1` logical host. Note that `_JF0` and `_JF1` were installed by using `JP1/AJS3 - Manager version 09-50`, and `_JF2` and `_JF3` were installed by using `JP1/AJS3 - Manager version 10-00` or later.

```

(1) *** Embeddb setup-id list 20XX/04/01 08:15:00
(2) Host-Name:JP1_DEFAULT

```

```

(3)      (4)      (5)      (6)
_JF0 08-05-DA OS_CONTROL C:\Program Files\HITACHI\JP1AJS2\embdb\_JF0
_JF1 08-05-DA OS_CONTROL C:\Program Files\HITACHI\JP1AJS2\embdb\_JF1

Host-Name:LHOST1
_JF2 08-05-DA AJS_CONTROL C:\Program Files\HITACHI\JP1AJS2\embdb\_JF2
_JF3 08-05-DA AJS_CONTROL C:\Program Files\HITACHI\JP1AJS2\embdb\_JF3
(7) --

```

Explanation of output items

- (1) The title and the time that the command was executed (in *YYYY/MM/DD hh:mm:ss* format)
- (2) Logical host name. For a physical host, JP1_DEFAULT is output.
- (3) Setup identifiers
- (4) Versions of embedded databases
- (5) Behavior of the embedded database

OS_CONTROL

Indicates that the embedded database has been installed under either of the following circumstances:

- JP1/AJS3 - Manager is upgraded from a version earlier than 10-00 to version 10-00 or later, and the setting to strengthen the embedded database management functionality is not specified for the embedded database.
- When the `ajsembdbinstl` command is executed with the `-v9standard` option specified.

For UNIX, the `pdprcd` process starts from `inittab`.

For Windows, the JP1/AJS3 Database ClusterService service is created. The startup type of the JP1/AJS3 Database service is *automatic*.

For details about the settings for enhancing the embedded DB management function, see *3.6.1 Settings for enhancing the embedded database management function* in the *JP1/Automatic Job Management System 3 Configuration Guide*.

AJS_CONTROL

Indicates that the embedded database was installed by using JP1/AJS3 - Manager version 10-00 or later.

For UNIX, the `pdprcd` process starts from `pdmgrd`.

For Windows, the JP1/AJS3 Database ClusterService service is not created. The startup type of the JP1/AJS3 Database service is *manual*.

- (6) Installation directories for embedded databases

- (7) End of output

Actions to be taken if an error occurs

If a command error occurs, take the action indicated in the following table.

| Message ID and message | Cause | Action taken |
|--|--|---|
| KAVS2116-E There is an error in the specified option. Illegal option (<i>option</i>) exists. | The specified option is incorrect. An invalid option has been specified. | Check the option and re-execute the command. |
| KAVS0903-E System error occurred. : Get Conf NG | An attempt to read the configuration definition failed. | Check the execution permission for the command, and re-execute the command. |

| Message ID and message | Cause | Action taken |
|---|---|---|
| KAVS0903-E System error occurred. : Get Conf NG | An attempt to read the configuration definition failed. | If this error occurs again, contact the system administrator. |

Return values

| | | |
|---|--------------|---|
| 0 | Normal end | Registered information is displayed (this value is also returned when there is no information to be displayed). |
| 4 | Abnormal end | An option is invalid. |
| 8 | Abnormal end | An attempt to read the configuration definition failed. |

ajsembdbinstl

Format

```
ajsembdbinstl
  -s embedded-database-installation-media-storage-directory
  [-mh logical-host-name]
  [-i embedded-database-installation-previous-directory]
  [-id setup-identifier]
  [-v9standard]
```

Description

The `ajsembdbinstl` command installs the JP1/AJS3 standard database (embedded database).

Execution privileges

In Windows: Administrators privileges

In UNIX: Superuser privileges

Storage directory

In Windows:

JP1/AJS3-installation-folder\tools\

In UNIX:

/opt/jp1ajs2/tools/

Arguments

-s *embedded-database-installation-media-storage-directory*

Specify the absolute path name of the directory that will store the embedded database installation media.

You must specify the following directory:

In Windows:

JP1/AJS3-installation-folder\tools\AJS3DB

In UNIX:

/opt/jp1ajs2/tools/AJS3DB

If the absolute path name you specify contains a space or parenthesis, enclose the entire path name in double quotation marks ("").

-mh *logical-host-name*

Specify the name of the logical host on which you want to install the embedded database. You can specify a character string of 1 to 32 bytes.

If you are using the physical host, you do not need to specify this option.

-i *embedded-database-installation-previous-directory*

Specify the absolute path name of the directory in which you want to install the embedded database. You can specify a character string of 1 to 118 bytes.

Make sure that you specify a path name that begins with a drive name.

The following shows the characters that can be used to specify the absolute path name.

For Windows

Alphanumeric characters, space characters, path separators (\), periods (.), underscores (_), left parentheses ((), and right parentheses ())

For UNIX

Alphanumeric characters, underscores (_), and slants (/)

If the absolute path name you specify contains a space or parenthesis, enclose the entire path name in double quotation marks (").

If this option is omitted, the following directory is assumed.

In Windows:

```
JP1/AJS3-installation-folder\embdb\_JFn
```

In UNIX:

```
/opt/jp1ajs2/embdb/_JFn
```

For *n* above, the *n* value in the setup identifier specified for the `-id` option is used.

For the `-id` option, make sure that you specify a directory that exists on a local disk.

When executing this command, you need to secure sufficient free space in the disk for the directory in which the embedded database is to be installed. For details about the required free space, see the *Release Notes*.

-id *setup-identifier*

Specify a four-character setup identifier, `_JFn` (*n*: 0 to 9 or A to Z), which identifies the embedded database.

If you omit this option, the system assumes `_JF0`.

-v9standard

This option is provided for compatibility and is specified to configure an embedded database with the method used in a version earlier than 10-00. Normally, it is not necessary to specify this option.

The following are differences between when this option is specified and when it is omitted:

In Windows:

When the `-v9standard` option is specified

- The JP1/AJS3 Database ClusterService service is created.
- The startup type of the JP1/AJS3 Database service is *automatic*.

When the `-v9standard` option is omitted

- The JP1/AJS3 Database ClusterService service is not created.
- The startup type of the JP1/AJS3 Database service is *manual*.

In UNIX:

When the `-v9standard` option is specified

The `pdprcd` process starts from `inittab`.

When the `-v9standard` option is omitted

The `pdprcd` process starts from the `pdmgrd` process.

If an overwrite installation is performed with the `-v9standard` option specified for an embedded database whose startup type for the JP1/AJS3 Database service is set to *manual*, the startup type does not change to *automatic*.

If an overwrite installation is performed with the `-v9standard` option omitted for an embedded database whose startup type for the JP1/AJS3 Database service is set to *automatic*, the startup type changes to *manual*.

Notes

- If the return value of this command is not 0, the following message is output: Database install failed (error code=yy) . In yy, the return value is indicated. If this message is output, take action appropriate for the indicated return value. For details, see 2.7.8(2) *Action to be taken if an error occurs during installation of the embedded database* in the manual *JP1/Automatic Job Management System 3 Troubleshooting*.
- In UNIX, when you install the embedded database by specifying the `-v9standard` option, the entry of the embedded database is registered in the `/etc/inittab` directory (in Linux, the `/etc/init` directory). When an overwrite installation is performed for the embedded database, the entry of the embedded database in the `/etc/inittab` directory is deleted and then re-registered. Therefore, the order of the entries in the `/etc/inittab` directory might change.
When you install the embedded database by omitting the `-v9standard` option, if the entry of the embedded database to be installed already exists, it is deleted and not re-registered.
- If `pd_mode_conf=AUTO` is specified in the system common definition file of the embedded database, the embedded database might automatically start after the overwrite installation. When the embedded database starts, stop it before the JP1/AJS3 service starts.
- Do not execute this command repeatedly in quick succession.

Return values

| | |
|---------------------|--------------|
| 0 | Normal end |
| Values other than 0 | Abnormal end |

ajsembdbsetup

Format

```
ajsembdbsetup
  [-mh logical-host-name]
  [-F service-name]
  [-p port-number]
  [-m [-s send-buffer-size] [-r receive-buffer-size]]
  [-ct maximum-wait-time]
  [-tp table-name-prefix]
  [-c]
  [-ru { l | m | s }]
  [-id setup-identifier]
  [-convert]
  [-del]
  [-e {byte | sjis}]
  [-b]
```

Description

The `ajsembdbsetup` command sets up an embedded database environment in which the database for the scheduler service and agent management can operate.

You can execute this command only when the embedded database is operating.

Execution privileges

In Windows: Administrators privileges

In UNIX: Superuser privileges

Storage directory

In Windows:

`JP1/AJS3 - Manager-installation-folder\tools\`

In UNIX:

`/opt/jplajs2/tools/`

Arguments

-mh *logical-host-name*

Specify the name of the JP1 logical host to be processed. You can specify a character string of 1 to 32 bytes.

If environment variable `JP1_HOSTNAME` is set when this option is omitted, the system assumes the logical host name specified in the environment variable. If `JP1_HOSTNAME` is not specified, the system assumes the physical host.

-F *service-name*

Specify the name of the scheduler service to be processed.

If environment variable `AJSCONF` is set when this option is omitted, the system assumes the service name specified in the environment variable. If `AJSCONF` is not specified, the system assumes the default scheduler service.

-p *port-number*

Specify a decimal number as the port number used for connection to the embedded database. Make sure that the port number you specify in this option is the port number specified in the `-p` option when the `ajsembdbbuild` command was executed.

If you omit this option, the system assumes 22220.

This communication port is set in the `RDBPORT` parameter for the configuration definition.

You can specify a value from 5001 to 65535.

-m [-s *send-buffer-size*] [-r *receive-buffer-size*]

Specify the sizes of send and receive buffers that are used for the inter-process memory communication function of the embedded database.

The function specified here is set in the `RDBIPC`, `RDBSENDMEMSIZE`, and `RDBRECVMEMSIZE` parameters of the configuration definition.

- `-s`
Specifies the send buffer size with a decimal number (unit: kilobytes).
- `-r`
Specifies the receive buffer size with a decimal number (unit: kilobytes).

For the `-s` and `-r` options, you can specify a value from 4 to 2,097,152.

If you omit the `-s` or `-r` option, the system assumes the standard embedded database values for operations.

The optimal values for JP1/AJS3 are: send buffers size = 100 and receive buffer size = 1600.

If you omit the `-m` option, the system uses the inter-process memory communication function, and assumes send buffer size = 100 and receive buffer size = 1600 regardless of the `-s` and `-r` options that you specify.

-ct *maximum-wait-time*

This option takes effect if the RDB connection wait function is used. Specify a value from 0 to 60 (in minutes) as the maximum wait time for connection to the RDB.

If you omit this option, the system assumes 1.

Specifying a value of 0 disables the RDB connection wait function.

If you specify a value outside the 0-60 range in this option, the invalid value is set in the configuration definition. As a result, the following error message might be output when JP1/AJS3 starts: KAVS1003-E Invalid specification in configuration definition. (*item-name*). In addition, the KAVA0334-E error message might be output while the `ajsembdbsetup` command is being executed.

-tp *table-name-prefix*

Specify the table name prefix of the JP1/AJS3 scheduler database by using no more than 4 bytes of half-width alphanumeric characters. Use uppercase characters to specify alphabetic characters.

If you omit this option, the system assumes `AJS1`.

In the configuration definition, the `TABLENAMEPREFIX` parameter settings are modified.

-c

Specify this option if you want to reset the scheduler services after a table creation error occurs, despite schema creation ending successfully.

-ru { l | m | s }

Specify this option to use the free area re-use function. When you specify -ru together with l, m, or s, you can specify the re-use start point.

When you omit this option, the system assumes -ru l.

Specify the re-use start point of the free area re-use function after -ru option. Free area is re-used when the usage rate of the database (table) area reaches the re-use start point specified in this option.

l, m, and s correspond to the large database model, medium database model, and small database model of ajsembdbbuild command, respectively. Specify the option that matches the size of the database model specified in ajsembdbbuild command.

The re-use start point of the free area re-use function for the database area is set as follows, for each table.

Table 2–1: Re-use start point of the free area re-use function for the database area set for each table

| Table name | Re-use start point of the free area re-use function for each table |
|---------------|---|
| AJS1UNIT | 6% of the segments of the entire AJS2DATA database area (Specify 18 when specifying s, 183 when specifying m, and 957 when specifying l.) |
| AJS1ARROW | |
| AJS1BODY | |
| AJSS1CH | |
| AJS1CAL | |
| AJS1PERF | |
| AJS1ENTRY | |
| AJS1GEN | |
| AJS1STAT | 16% of the segments of the entire AJS2DATA database area (Specify 48 when specifying s, 489 when specifying m, and 2553 when specifying l.) |
| AJS1RELS | 6% of the segments of the entire AJS2DATA database area (Specify 18 when specifying s, 183 when specifying m, and 957 when specifying l.) |
| AJS1ID | |
| AJSAGTEXECNT | 1% of the segments of the entire AJS2DATA database area (Specify 3 when specifying s, 30 when specifying m, and 159 when specifying l.) |
| AJSEXECAGT | |
| AJSEXECAGTGRP | |
| AJSLINKAGT | |
| AJS1JINF# | 70% of the segments of the entire AJS2DATA2 database area (Specify 70 when s, m, or l is specified.) |

#:

This table is created only if the backup enhancement function is enabled.

Note

The above table names are used when the standard table prefix (AJS) is used.

The total number of area segments in the large, medium, and small database models of `ajsembdbbuild` command are as follows.

Table 2–2: Total number of area segments created in the large, medium, and small database models of `ajsembdbbuild`

| Database area name | Small | Medium | Large |
|----------------------------------|-------|--------|--------|
| Data area AJS2DATA | 300 | 3,060 | 15,960 |
| Data area AJS2DATA2 [#] | 100 | 100 | 100 |

#:

This area is only created if the backup enhancement function is enabled.

-id *setup-identifier*

Use four characters, `_JFn` (n is from 0 to 9 or from A to Z), to specify the setup identifier for identifying the embedded database. Specify the value specified in the `-id` option of the `ajsembdbbuild` command.

If you omit this option, the system assumes `_JF0`.

-convert

Specify this option if you want to perform advanced setup after JP1/AJS2 - Manager has been upgraded to JP1/AJS3 - Manager.

-del

This option is specified to restore processing if an error occurs during advance setup performed by specifying the `-convert` option.

Before you execute the command with the `-del` option, make sure that the option settings that were specified when the error occurred are also specified. If you specify different option settings, restoration processing might not be performed normally.

This option is also specified when the database is set up to allow the same number of characters to be specified for items such as a unit name in both Shift-JIS and UTF-8 environments. In this case, this option deletes the database that has already been set up.

If you execute the `ajsembdbsetup` command with the `-convert`, `-p`, and `-tp` options omitted but the `-del` option specified, the value set when the scheduler service was built is assumed for the `-p` and `-tp` options.

-e {*byte|sjis*}

Specifies for the database of the specified scheduler service whether the same number of characters can be specified for items such as a unit name in both Shift-JIS and UTF-8 environments. If you omit this option, the system assumes `byte`.

If you omit this option in Linux, `byte` is specified for the `DEFLENTYPE` environment setting parameter. If you omit this option in AIX, HP-UX, or Solaris, the value of the `DEFLENTYPE` environment setting parameter does not change.

You cannot specify this option with the `-convert` or `-del` option. If you do so, an error occurs.

In addition, if a value other than UTF-8 is specified for the `AJSCHARCODE` environment setting parameter for the scheduler service specified in the `-F` option, an error occurs and the KAVS1516-E message is output.

Note that this option can be specified in UNIX, and cannot be specified in Windows.

- `byte`

The database is set up so that the number of characters specifiable in a UTF-8 environment becomes the number of characters specified after conversion in UTF-8. If this option is specified, the number of characters specifiable for items such as a unit name in a Shift-JIS environment and a UTF-8 environment will not be the same.

If you execute the command with this option specified, `byte` is specified for the `DEFLENTYPE` environment setting parameter.

- `sjis`

The database is set up so that the number of characters specifiable in a UTF-8 environment is converted to the number of characters specifiable in a Shift-JIS environment. If this option is specified, the number of characters that can be used in the following definition items for a unit in a UTF-8 environment is the same as that in a Shift-JIS environment:

- **Unit name** in the detailed unit definition
- **Comment** in the detailed unit definition
- **Exclusive jobnet** in the schedule settings

Before setting up the database with this option specified, make sure that the database of the specified scheduler service has not been set up yet. If the database has already been set up, executing the command will result in an error.

If you execute the command with this option specified, `sjis` is specified for the `DEFLENTYPE` environment setting parameter.

-b

This option is specified to set up the database for the backup enhancement function.

Specify this option if the backup enhancement function is enabled. If you do not specify this option, an error occurs. Do not specify this option if the backup enhancement function is disabled. If you do so, an error occurs.

You can check the setting of the backup enhancement function by using the `ajsembdbstatus` command. For details about the `ajsembdbstatus` command, see [ajsembdbstatus](#) in *3. Commands Used for Normal Operations*.

You cannot specify this option with the `-convert` or `-del` option. If you do so, an error occurs.

Notes

- Before executing `ajsembdbsetup` command, stop all the JP1/AJS3 services, including the logical host in the JP1/AJS3 - Manager host. Note that `ajsembdbsetup` command may terminate normally even if these services are not stopped. Also, the JP1/AJS3 logical host must be reachable using the IP address resolved from the logical host name specified in the `-mh` option.
- The `ajsembdbsetup` command is incorporated in a script. For this reason, specifying a long character string or an invalid character string or value may result in an unexpected error. In the options, specify the character strings and numeric values defined in the DBMS and JP1/AJS3.
- Even if an error that occurred is in a configuration definition not necessary for scheduler database setup, the following error message is output: KAVS1003-E Invalid specification in configuration definition. (*item-name*). Setup is complete upon the normal termination of `ajsembdbsetup` command. You do not have to perform setup again even if this message is output repeatedly. After terminating `ajsembdbsetup` command, correct any configuration definition errors as prompted by the error message KAVS1003-E.
- To create an environment by changing the character encoding in UNIX, set the `LANG` environment variable correctly.
- If an error occurs in embedded database access when the `ajsembdbsetup` command is executed, embedded database connection error information is output to `pderr1.trc` and `pderr2.trc` files in the work directory for the `ajsembdbsetup` command. If you re-execute the command and the command terminates normally, delete these files.

- Do not execute `ajsembddbsetup` command repeatedly in quick succession. If you do so, the following problems might occur:
 - The scheduler database becomes invalid and can no longer be used.
 - The `ajsembddbsetup` command results in an error.
 - The configuration definition information becomes invalid, disabling further operation of JP1/AJS3.
- If an error occurs when the `ajsembddbsetup` command with the `-e sjis` option specified is executed, re-execute the command with the `-c` option specified. If you re-execute the command with the `-c` option specified but without also specifying the `-e sjis` option, an error occurs and the KAVS0980-E message is output.
- If an error occurs when the `ajsembddbsetup` command without the `-e sjis` option specified is executed, re-execute the command with the `-c` option specified. If you re-execute the command by specifying both the `-c` and `-e sjis` options, an error occurs and the KAVS0980-E message is output.

Actions to be taken if an error occurs

An error may occur during `ajsembddbsetup` command execution. If an error occurs, correct the cause of the error according to the table below, and then re-execute this script.

| Message ID | Cause | Action taken |
|---|--|--|
| Invalid value specified in <code>-ct</code> option. | An invalid argument is specified in the argument of the <code>-ct</code> option. | Specify an integer, ranging from 0 to 60, in the argument of the <code>-ct</code> option. |
| KAVS0178-E | The table is already created. | Make sure that the value of the <code>-tp</code> option is different from a table name prefix that has already been registered. Alternatively, delete the existing tables by executing the command with the same option settings, in addition to the <code>-del</code> option, specified, and then re-execute the command. |
| KAVS0190-E | The specified scheduler service is not defined in the host. | Specify an existing scheduler service name in the <code>-F</code> option. |
| KAVS0980-E | The database table configuration is not compatible. | In an environment in which the command was executed with the <code>-e sjis</code> option specified, the command was re-executed by specifying the <code>-c</code> option but not specifying the <code>-e sjis</code> option. In an environment in which the command was executed without the <code>-e sjis</code> option specified, the command was re-executed by specifying both the <code>-c</code> and <code>-e sjis</code> options. When re-executing the command, specify the <code>-e</code> option the same way it was specified in the original command. |
| KAVS0985-E | The embedded database server cannot be connected to the database. | Possible causes for this error are as follows: The embedded database is not started. The port number specified in the <code>-p</code> option does not match the port number of the embedded database. Correct these causes and then re-execute this command. |
| KAVS0996-E | The specified option and value are invalid. | Correct the specified option and value. |
| KAVS1003-E | The configuration definition includes an invalid specification. | Correct the value specified in the option and then re-execute this command. |
| KAVS2116-E | The value specified in the option is invalid, or options that cannot be specified together were specified. | Correct the options and the value specified for the options, and then re-execute this command. |
| KAVS8404-E | The backup enhancement function is disabled. | Re-execute the command without the <code>-b</code> option specified. |

| Message ID | Cause | Action taken |
|--|---|--|
| KAVS8404-E | The backup enhancement function is disabled. | You can check the setting of the backup enhancement function by using the <code>ajsembdbstatus</code> command. For details about the <code>ajsembdbstatus</code> command, see <i>ajsembdbstatus</i> in 3. <i>Commands Used for Normal Operations</i> . |
| KAVS8409-E | The backup enhancement function is enabled. | Re-execute the command with the <code>-b</code> option specified. You can check the setting of the backup enhancement function by using the <code>ajsembdbstatus</code> command. For details about the <code>ajsembdbstatus</code> command, see <i>ajsembdbstatus</i> in 3. <i>Commands Used for Normal Operations</i> . |
| KFPA11723-E | The embedded database is stopped. | Start the embedded database. |
| KFPA11204-E | There is no table. | Review the value of the <code>-tp</code> option, and specify a correct table prefix. Then, re-execute the command. |
| KFPA11563-E KFPA11732-E | Because another user is accessing the embedded database, a lock wait timeout occurred. | Stop all accesses to the embedded database, and then re-execute the command. |
| The embedded DB work directory associated with the setup identifier specified by the <code>-id</code> option is invalid. | The embedded database practical directory associated with the setup identifier specified in the <code>-id</code> option is invalid. | Specify a correct value for the embedded database practical directory set in the configuration definition and re-execute the script. To check the registered setup identifiers and embedded database practical directories, execute the <code>ajsembdbidlist</code> command. For details on the <code>ajsembdbidlist</code> command, see <i>ajsembdbidlist</i> in 2. <i>Commands Used during Setup</i> . |
| The setup identifier specified with the <code>-id</code> option is not registered. | The setup identifier specified in the <code>-id</code> option is not registered. | Specify a setup identifier that is already registered and re-execute the script. To check the registered setup identifiers and embedded database practical directories, execute the <code>ajsembdbidlist</code> command. For details on the <code>ajsembdbidlist</code> command, see <i>ajsembdbidlist</i> in 2. <i>Commands Used during Setup</i> . |
| Failed to register the configuration definition. | Registering the configuration definition failed. | If advanced setup has been performed, specify also the <code>-del</code> option to delete the existing tables, and then re-execute the command. |

For details on the messages beginning with KAVS, see 3. *Messages beginning with KAVS (Messages about the scheduler and the common processing)* in the manual *JPI/Automatic Job Management System 3 Messages*.

Return values

| | |
|---------------------|--------------|
| 0 | Normal end |
| Values other than 0 | Abnormal end |

ajsembdbuninstl

Format

```
ajsembdbuninstl
  {-mh logical-host-name |
   -id setup-identifier}
```

Description

The `ajsembdbuninstl` command uninstalls the JP1/AJS3 standard database (embedded database).

You can execute this command regardless of the operating status of the embedded database. Note, however, that all scheduler services for which the scheduler database is set up in the embedded database environment to be uninstalled must be stopped when the command is executed.

Execution privileges

In Windows: Administrators privileges

In UNIX: Superuser privileges

Storage directory

In Windows:

`JP1/AJS3 - Manager-installation-folder\tools\`

In UNIX:

`/opt/jp1ajs2/tools/`

Arguments

-mh *logical-host-name*

Specify the name of the logical host on which you want to perform uninstallation. All embedded databases installed on the specified logical host will be uninstalled.

You can specify a character string of 1 to 32 bytes.

You cannot specify `JP1_DEFAULT` in this option.

To uninstall the embedded databases from the physical host, specify the `-id` option.

-id *setup-identifier*

Specify a four-character setup identifier, `_JFn` (*n*: 0 to 9 or A to Z), which identifies the embedded database to be uninstalled.

You can specify this option for uninstallation on either the physical or logical host.

Do not uninstall the following embedded databases because they contain information required by the system:

- The embedded database whose setup identifier is `_JF0`

- The first embedded database set up on a host where an embedded database setup identifier is changed to other than `_JF0` by performing data migration during embedded database advance setup, embedded database advance setup, or embedded database re-setup
- The embedded database set up with the setup identifier specified in the `-I` option of the `jajs_setup_cluster` command in an environment in which a logical host is set up

For details on the `jajs_setup_cluster` command, see *jajs_setup_cluster* in [2. Commands Used during Setup](#).

Notes

- If the return value of this command is not 0, the following message is output: Database uninstall failed (error code=yy) . In yy, the return value is indicated. If this message is output, take action appropriate for the indicated return value. For details, see [2.7.8\(3\) Action to be taken if an error occurs during uninstallation of the embedded database](#) in the manual *JP1/Automatic Job Management System 3 Troubleshooting*.

If information about an uninstalled embedded database remains in the JP1/AJS3 common definition information, the `ajsembdbuninstl` command might fail. If such information remains, delete the common definition information by executing the command shown below. For details on the `jbsunsetcnf` command, see the *JP1/Base User's Guide*.

```
jbsunsetcnf -i -h JP1_DEFAULT-or-logical-host-name -c JP1AJS2 -n EMBDBINST
ALL
```

If no information has been set when the command is executed, the following message might be output: KAVA0405-I The specified sub-key does not exist (*JP1_DEFAULT or logical-host-name\JP1AJS2\EMBDBINSTALL*) . Processing stops.. However, you can ignore this message.

- This command does not delete the embedded database installation directory or the embedded database data area directory. If these directories are no longer necessary, delete them manually.
- In UNIX, when you uninstall the embedded database, if the entry of the embedded database exists in the `/etc/inittab` directory (in Linux, the `/etc/init` directory), it is deleted.
- Do not execute this command repeatedly in quick succession.

Return values

| | |
|---------------------|--------------|
| 0 | Normal end |
| Values other than 0 | Abnormal end |

ajsembdbunset

Format

```
ajsembdbunset
  {-r[-e] | -e[-r]}
  [-id embedded-database-setup-identifier]
  [-i embedded-database-practical-directory-name]
```

Format 1 (for canceling the setup of the embedded database (UNIX only))

```
ajsembdbunset
  -r
  [-id embedded-database-setup-identifier]
  [-i embedded-database-practical-directory-name]
```

Format 2 (for deleting the embedded database environment)

```
ajsembdbunset
  -e
  [-id embedded-database-setup-identifier]
  [-i embedded-database-practical-directory-name]
```

Description

Cancel the setup of the embedded database.

You can execute this command regardless of the operating status of the embedded database. You can execute the command only when all the scheduler services for which the target embedded database has been created as the scheduler database are inactive.

Execution privileges

In Windows: Administrators privileges

In UNIX: Superuser privileges

Storage directory

In Windows:

JP1/AJS3 - Manager-installation-folder\tools\

In UNIX:

/opt/jp1ajs2/tools/

Arguments

-r

You do not need to specify this option. If you specify it, processing ends without removing the embedded database setup.

-e

Specify this option to delete the embedded database environment.

The data in the embedded database will be deleted. If you want to keep the data, save it somewhere else beforehand.

In UNIX, if the `-e` option is specified, the `-r` option is also implicitly specified. That is, the registration of the embedded database running in the specified directory is canceled in the operating system.

-id *embedded-database-setup-identifier*

Use four characters, `_JNn` (*N*: the character specified during setup of the embedded database environment, *n*: 0 to 9 or A to Z), to specify the setup identifier of the embedded database.

If you omit this option, the system assumes `_JF0`.

To check the registered setup identifiers and embedded database practical directories, execute the `ajsembdbidlist` command.

For details on the `ajsembdbidlist` command, see *ajsembdbidlist* in 2. *Commands Used during Setup*.

-i *embedded-database-practical-directory-name*

Specify the name of the embedded database practical directory.

You must specify this option only when cancellation of the setup specified by using the `-id` option fails for example, when the `ajsembdbbuild` command does not end normally.

Notes

- When you execute `ajsembdbunset` command, the following message appears:
message: `ssss Embeddb DELETE? (y/n) :`
`ssss: setup-identifier`
This is a confirmation message for asking you whether you want to delete the environment. If the deletion will cause no problems, enter `y`.
- When you execute `ajsembdbunset` command, check whether the specified operation directory is correct.
- Before you execute `ajsembdbunset` command, stop all the JP1/AJS3 services on the JP1/AJS3 - Manager host (including logical hosts). The command may end normally even if you execute the command without stopping the services.
- The `ajsembdbunset` command forcibly shuts down the embedded database even if the scheduler service is operating. You need to check whether the scheduler service is operating.
- The `ajsembdbunset` command is implemented by a script. If you specify an illegally long character string or a invalid character string or value for the options, an unexpected error may occur. You must specify a character string or a number within the range specified by the DBMS and JP1/AJS3.
- Do not execute `ajsembdbunset` command repeatedly in quick succession. If you do so, the following problems might occur:
 - The message output is invalid. For example, an invalid message is output or a message that should be output is not output.
 - The `ajsembdbunset` command results in an error.
- In a cluster system, execute the `ajsembdbunset` command on both the primary and secondary hosts. On the primary host (the host specified in the `-eh` option of the `ajsembdbbuild` command), make sure that the shared disk is mounted before executing the `ajsembdbunset` command. You must execute the `ajsembdbunset` command on the primary host first. If you attempt to execute the `ajsembdbunset` command on the secondary host with the shared disk mounted before executing the command on the primary host, the following message

is output and an error occurs: KFPS04619-E Unable to execute aa....aa command due to HiRDB unit not offline or not terminate normally(S+R). If this message is output, execute the ajsembdbunset command on the primary host with the shared disk mounted, and then re-execute the ajsembdbunset command with the -i option specified on the secondary host.

- If the embedded database has been stopped forcibly or has terminated abnormally, restart it, normally terminate it, and then execute the command.

Return values

| | |
|---------------------|-----------------|
| 0 | Ends normally |
| Values other than 0 | Ends abnormally |

Actions to be taken if an error occurs

If an error occurs, take the action indicated in the following table.

| Message ID | Phenomenon | Action taken |
|------------|--|---|
| KAVS0996-E | The specified option is incorrect. | Check the specification of the option. |
| KAVS2104-E | The embedded database is not set up. | The environment of the embedded database has already been deleted. |
| KAVS2115-E | The embedded database is not installed. Alternatively, access permission for the path specified in the -i option does not exist. | The embedded database to be deleted is not installed. Review the specified path, and then re-execute the command. If the AJS administrator is executing the command, make sure that the AJS administrator has execution privileges. |
| KAVS2116-E | The specified option is incorrect. | Check the option output in the message and re-execute the command. |
| KAVS2117-E | An error occurred when you executed the command. | Check the message output in the maintenance information. |

ajssetup

Format

```
ajssetup
  [-F service-name]
  [-t | [-m]]
  [-mh logical-host-name]
```

Description

The `ajssetup` command sets up the suspend function.

Execution privileges

In Windows: Administrators privileges

In UNIX: Superuser privileges

Arguments

-F *service-name*

Specify the service name of the scheduler service to be processed.

You can specify a name of 1 to 30 characters (bytes).

If you omit this option, the system assumes the default scheduler service name.

-t

Specify this option to set up the ISAM database to be used by the scheduler service in a compatible ISAM configuration.

-m

Enables the suspend function.

Specify this option when you change the definition during the registration of a jobnet for execution. Immediately after installation, the suspend function is disabled.

-mh *logical-host-name*

You can specify a logical host name instead of environment variable `JP1_HOSTNAME`. Specifying this option causes the host name specified in this option to precede that specified in environment variable `JP1_HOSTNAME`.

Specifying `JP1_DEFAULT` in this option also enables you to specify a physical host explicitly. Specifying the machine name of a physical host does not make it possible to set up a the physical host.

Notes

- If you specify the `-m` option to enable the suspend function, you do not have to stop the JP1/AJS3 service and the scheduler service. The setting is immediately enabled. However, you can operate from JP1/AJS3 - View only after you log in after the suspend function is enabled.
- You cannot execute more than one `ajssetup` command at any one time. To specify several `ajssetup` commands, set up the specification such that they are executed one by one.

Return values

| | |
|-----------------------------|--------------|
| 0 | Normal end |
| Multiple of 4 from 4 to 124 | Abnormal end |

Example

The following `ajssetup` command creates the table that is used by the scheduler service (`service1`).

```
ajssetup -F service1
```

ajssysctlsetup

Format

For JP1/AJS3 - Manager:

```
ajssysctlsetup
  [[-m] [-a] | [-u]]
```

For JP1/AJS3 - Agent:

```
ajssysctlsetup
  [[-a] | [-u]]
```

Description

The `ajssysctlsetup` command sets up the management portal execution environment. The command is also used to undo the setup.

The following shows the information set by this command.

Registering services

This command registers the following services in a Windows environment only:

| Service to be registered | Service name | Display name | Startup Type | Account | JP1/AJS3 - Manager | JP1/AJS3 - Agent |
|---|---------------------------------|---------------------------------|--------------|---------|--------------------|------------------|
| JP1/AJS3 System Control Manager Service | JP1_AJS3_System_Control_Manager | JP1/AJS3 System Control Manager | Automatic | System | Y | -- |
| JP1/AJS3 System Control Agent Service | JP1_AJS3_System_Control_Agent | JP1/AJS3 System Control Agent | Automatic | System | Y | Y |

Setting the communication port

Registers the following communication ports in the `services` file:

| Service to be registered | Service name in the services file: port number | JP1/AJS3 - Manager | JP1/AJS3 - Agent |
|---|--|--------------------|------------------|
| JP1/AJS3 System Control Manager Service | jp1ajs3sysctlm: 22256 | Y | -- |
| JP1/AJS3 System Control Agent Service | jp1ajs3sysctla: 22257 | Y | Y |

Setting environment setting parameters

This command sets the environment setting parameters that are used in the management portal execution environment.

| Service to be registered | Setting information | | JP1/AJS3 - Manager | JP1/AJS3 - Agent |
|---|---------------------------------------|--------------------------------|--------------------|------------------|
| | Definition key | Environment setting parameters | | |
| JP1/AJS3 System Control Manager Service | [JP1_DEFAULT\JP1AJS2\CONTROL] | "SYSLOGCODE"="C" | Y | -- |
| | [JP1_DEFAULT\JP1AJS2\CONTROL\MANAGER] | "LOGSIZE"=dword:00002800 | Y | -- |

| Service to be registered | Setting information | | JP1/AJS3 - Manager | JP1/AJS3 - Agent |
|---|---------------------------------------|--------------------------------|--------------------|------------------|
| | Definition key | Environment setting parameters | | |
| JP1/AJS3 System Control Manager Service | [JP1_DEFAULT\JP1AJS2\CONTROL\MANAGER] | "MAXOPEEXEC"=dword:00000005 | Y | -- |
| JP1/AJS3 System Control Agent Service | [JP1_DEFAULT\JP1AJS2\CONTROL] | "SYSLOGCODE"="C" | Y | Y |
| | [JP1_DEFAULT\JP1AJS2\CONTROL\AGENT] | "LOGSIZE"=dword:00002800 | Y | Y |
| | | "MAXOPEEXEC"=dword:00000005 | Y | Y |

Legend:

Y: This option is set.

--: This option is not set.

For details about environment setting parameter, see *20.15 Management Portal execution environment in the JP1/Automatic Job Management System 3 Configuration Guide*.

Execution privileges

In Windows: Administrators privileges

In UNIX: Superuser privileges

Storage directory

In Windows:

JP1/AJS3 - Manager-installation-folder\bin

JP1/AJS3 - Agent-installation-folder\bin

In UNIX:

/opt/jplajs2/bin/

Arguments

-m

Sets up the JP1/AJS3 System Control Manager service.

You can specify this option only when you perform setup for JP1/AJS3 - Manager. It cannot be specified with JP1/AJS3 - Agent.

This option cannot be specified together with the `-u` option.

-a

Sets up the JP1/AJS3 System Control Agent service.

This option cannot be specified together with the `-u` option.

-u

Undoes setup of the management portal execution environment.

This option cannot be specified together with the `-m` or `-a` option.

In Windows, this argument stops the JP1/AJS3 System Control Manager service and the JP1/AJS3 System Control Agent service. And this argument deletes the JP1/AJS3 System Control Manager service (JP1/AJS3 System Control Manager) and the JP1/AJS3 System Control Agent service (JP1/AJS3 System Control Agent) from the service list in the Administrative Tools.

In UNIX, before undoing setup, stop the JP1/AJS3 System Control Manager service and the JP1/AJS3 System Control Agent service.

Notes

- If you omit all options, the following options are assumed:
 - JP1/AJS3 - Manager: `-m`, `-a`
 - JP1/AJS3 - Agent: `-a`
- On a Windows host, before you execute a command that must be executed by a user with administrator privileges, make sure that you open the Command Prompt window as an administrator. If the UAC function is disabled, you do not need to open the Command Prompt window as an administrator.

Return values

| | |
|----------------------|--------------|
| 0 | Normal end |
| A value other than 0 | Abnormal end |

ajswebsetup

Format

```
ajswebsetup
  -c|-p|-d shared-directory [-m|-s]
```

Description

- The `ajswebsetup` command sets up an environment in which the Web Console server can operate in a cluster configuration. The setup must be performed on both the primary and secondary nodes. If the `-m` option is specified to set up the primary node, the environment definition file on the local disk with JP1/AJS3 - Web Console installed is copied to the shared disk. Then, an environment in which the Web Console server can operate in a cluster configuration is set up.
- The `ajswebsetup` command resets the Web Console server settings so that the environment definition file on the local disk with JP1/AJS3 - Web Console installed is used for operation.
- The `ajswebsetup` command displays the settings set up for the Web Console server.

Execution privileges

- In Windows: Administrators privileges
- In UNIX: Superuser privileges

Storage directory

In Windows:

JP1/AJS3 - Web Console-installation-folder\bin\

In Linux:

/opt/jp1ajs3web/bin/

Arguments

-c

Displays the settings. The following table lists and describes the displayed items:

| No. | Displayed item | Description |
|-----|------------------|---|
| 1 | shared directory | When a shared directory is used, the path to the shared directory is displayed. |

-p

Resets the Web Console server settings so that the environment definition file on the local disk with JP1/AJS3 - Web Console installed is used for operation.

-d *shared-directory-name*

Specifies the path to the shared directory when a cluster configuration is used. You must specify an existing directory.

You can specify a character string of 2 to 100 bytes in Linux, 4 to 100 bytes in Windows.

In Windows, if you specify a character string other than a drive (for example `-C :`) for the first two bytes, the command terminates abnormally.

Specify an absolute path. If an absolute path is not used, the command terminates abnormally.

You cannot specify the root directory (for example, / in Linux, C:\ in Windows).

You cannot specify a disk on a network drive.

You cannot specify a path that contains a multi-byte character.

A shared directory is created in *specified-shared-directory-name*\jps1ajs3web (in Windows) or *specified-shared-directory-name*/jps1ajs3web (in Linux). Then, under that shared directory, an environment definition file necessary for operating the Web Console server in a cluster configuration is created. Note, however, that if these directories already exist when the `-m` option is specified, the command terminates abnormally. If you specify the `-m` option, make sure that these directories do not exist before executing the command.

-m

Sets up a cluster configuration (executing system).

You must specify this option with the `-d` options. If the directory you specify in `-d` option does not exist, the command terminates abnormally.

Before you execute the command on the primary node, make sure that the shared disk is mounted.

-s

Sets up a cluster configuration (standby system).

You must specify this option with the `-d` options.

For the `-d` option, be sure to specify the shared directory that was specified on the primary node.

Notes

- If the UAC function is enabled, you need to open the Command Prompt window as an administrator when executing this command. To open the Command Prompt window, in the Windows Start menu, right-click **Command Prompt**, and then click **Run as administrator** in the shortcut menu. If the UAC function is disabled, you do not need to open the Command Prompt window as an administrator.
- Logs output by this command are always output to a physical host in a cluster configuration environment. Similarly, this command always references environment settings files on a physical host.
- Executing the `ajswbsetup` command might return the settings in the user properties file for J2EE servers (`usrconf.properties`)[#] to the initial state and cause the JP1/AJS3 Web Application Server service to fail to start. If this occurs, respecify the settings after executing the command.

This problem occurs when the following conditions are met:

1. The settings in the user properties file for J2EE servers (`usrconf.properties`) are changed before the `ajswbsetup` command is executed.
2. The `ajswbsetup` command is executed with the `-d` or `-p` option specified.

#

For the settings in the user properties file for J2EE servers (`usrconf.properties`) that are used during setup of JP1/AJS3 - Web Console, see the following:

In Windows: *3.4.6 Details on the settings in the user properties file for J2EE server (usrconf.properties) in the JP1/Automatic Job Management System 3 Configuration Guide*

In Linux: *13.3.6 Details on the settings in the user properties file for J2EE server (usrconf.properties) in the JP1/Automatic Job Management System 3 Configuration Guide*

Return values

| | |
|----------------------|--------------|
| 0 | Normal end |
| A value other than 0 | Abnormal end |

Example

In this example, the command sets up a cluster configuration (executing system).

```
ajswebsetup -d shared-directory -m
```

Output example

The following is an example of file output when you specify the `-c` option.

```
KNAK2520-I Output of settings data will now start.  
shared directory    E:\share  
KNAK2521-I Output of settings data ended.
```

jajs_config

Format

```
jajs_config
  -k definition-key-name
  environment-setting-parameter-name=definition ...
```

Description

The `jajs_config` command changes the JP1/AJS3 environment settings.

Execution privileges

In Windows: Administrators privileges

In UNIX: Superuser privileges

Arguments

-k *definition-key-name*

Specify the name of the definition key under which you set an environment setting parameter.

Make sure that the definition key name is enclosed in square brackets ([]).

You cannot specify multiple definition key names. You can only specify the environment setting parameter or environment setting parameters that correspond to one definition key name at each command execution.

If the specified definition key name is incorrect, this command terminates abnormally. For details, see 20. *Environment Setting Parameters* in the *JP1/Automatic Job Management System 3 Configuration Guide*.

***environment-setting-parameter-name=definition* ...**

Specify one or more pairs of environment setting parameter name and value you want to set.

If the specification contains an error, this command terminates abnormally. For details, see 20. *Environment Setting Parameters* in the *JP1/Automatic Job Management System 3 Configuration Guide*.

If you specify a numeric value, use `dword:hexadecimal-number` format. If you specify multiple values for an environment setting parameter, separate the values by using a colon (:).

If you specify multiple pairs of environment setting parameter name and value, separate the pairs by using a space character.

Notes

- The time when the environment setting parameters set by this command take effect differs depending on the parameter. For details, see the description of the environment setting parameter in 20. *Environment Setting Parameters* in the *JP1/Automatic Job Management System 3 Configuration Guide*.
- If you specify environment setting parameters that are not applicable to the specified definition key, the command terminates abnormally. For definition keys and applicable environment setting parameters, see 20. *Environment Setting Parameters* in the *JP1/Automatic Job Management System 3 Configuration Guide*.

- You cannot specify multiple definition keys in this command. If you need to specify multiple definition keys, execute the command for each definition key or use the `jbssetcnf` command. For details on the `jbssetcnf` command, see the *JPI/Base User's Guide*.
- Do not execute this command more than once in quick succession.
- Do not terminate this command forcibly.
- This command checks the values specified in environment setting parameters that can take different values in Windows and UNIX. The command ends normally if each of the defined values falls within the allowed scope given in the following table.

| Category | Parameter | Condition |
|---|------------------|---|
| System-managed environment settings | "AJSSYSDIR" | A string of no more than 191 bytes |
| | "AJSLOGDIR" | A string of no more than 191 bytes |
| Scheduler service environment settings | "LOGSIZE" | A hexadecimal number from 0 to 1E8480 (units: KB) (equivalent decimal number: from 0 to 2,000,000) |
| | "AJSTMPDIR" | A string of no more than 191 bytes |
| | "JOBINFDIR" | A string of no more than 191 bytes |
| | "AJSBKUROOT" | A string of no more than 191 bytes |
| | "AJSDBDIRECTOR" | A string of no more than 191 bytes |
| | "AJSSYSDIR" | A string of no more than 191 bytes |
| | "AJSLOGDIR" | A string of no more than 191 bytes |
| | "AJSREPORTDIR" | A string of no more than 191 bytes |
| Agent management control environment settings | "AJSODBC_DSNAME" | A string of no more than 255 bytes |

For details about the values that can be specified for the above environment setting parameters in the relevant OS, see 20. *Environment Setting Parameters* in the *JPI/Automatic Job Management System 3 Configuration Guide*.

- This command cannot change the value of the environment setting parameter `DEFLENTYPE`, which is automatically set by the `ajsembdbsetup` command.

Return values

| | |
|---------------|--|
| 0 to 9 | Normal end |
| 10 to 49 | End with warning. The command terminated but requires manual operations. |
| 50 or greater | Abnormal end |

Example

In this example, the command changes the settings of scheduler service `AJSROOT1` on physical host `JP1_DEFAULT` as follows:

- Changing the size of the scheduler log file to 10,240 (2800 in hexadecimal) KB
- Enabling outputting of the scheduler service startup and termination messages to the scheduler log file

For Windows

```
jajs_config -k [JP1_DEFAULT\JP1AJSMANAGER\AJROOT1] "LOGSIZE"=dword:00002800 "AJSLOG"="all"
```

For UNIX

```
jajs_config -k "[JP1_DEFAULT\JP1AJSMANAGER\AJROOT1]" "LOGSIZE"=dword:00002800 "AJSLOG"="all"
```

Note

The value specified for the `-k` option or on the command line might contain a backslash (`\`) or space character. If a backslash (`\`) or space character is contained, you must, for example, enclose the option or parameter value in double quotation marks (`"`) or single quotation marks (`'`), or replace a backslash (`\`) with two backslashes (`\\`). For details, see the OS documentation or other applicable reference.

jajs_migrate

Format

```
jajs_migrate
  [-h logical-host-name]
  {-C|-convert
    [-T work-directory-name]
    [-r|-f]
    [-S | [[-s {l|m|s}]]
      [-u number-of-scheduler-services-to-be-stored-in-one-database]]
  ]}
```

Format 1 (standard setup on a physical host)

```
jajs_migrate
  -convert
  [-T work-directory-name]
  [-s {l|m|s}]
  [-u number-of-scheduler-services-to-be-stored-in-one-database]
```

Format 2 (for setting up a logical host)

```
jajs_migrate
  -convert
  [-h logical-host-name]
  [-T work-directory-name]
  {-r|-f}
  -S
```

Format 3 (for manually setting up the embedded database on the physical host)

```
jajs_migrate
  -convert
  [-T work-directory-name]
  -S
```

Format 4 (for outputting the current database configuration)

```
jajs_migrate
  [-h logical-host-name]
  -C
```

Description

The `jajs_migrate` command sets up JP1/AJS3 in the standard configuration.

Perform setup after an upgrade installation from JP1/AJS2 to JP1/AJS3. You can execute this command only when the database for a JP1/AJS2 scheduler service can be accessed.

You can also use this command to output the current database configuration to the standard output file.

Execution privileges

In Windows: Administrators privileges

In UNIX: Superuser privileges

Storage directory

In Windows:

```
JP1/AJS3 - Manager-installation-folder\tools\
```

In UNIX:

```
/opt/jplajs2/tools/
```

Arguments

-convert

Specify this option to set up JP1/AJS3 in the standard configuration.

-h *logical-host-name*

Specify this option if you want to specify a logical host name, instead of using the JP1_HOSTNAME environment variable. You can specify a character string of 1 to 32 bytes.

The value of this option overrides the value of the JP1_HOSTNAME environment variable. By specifying JP1_DEFAULT as the value of this option, you can explicitly specify the physical host. You can also specify the computer name of the physical host.

Note, if a logical host is set up with the same name as the physical host name, the logical host is still treated as a logical host rather than the physical host.

-T *work-directory-name*

Specify the name of the work directory use for migration.

You need to specify this option if free space required for the default work directory cannot be secured. The default work directory is as follows.

For Windows, if the installation folder is the default installation folder or is in a folder protected by the system:

```
%ALLUSERSPROFILE%\Hitachi\JP1\JP1_DEFAULT\JP1AJS2\backup
```

The default value of %ALLUSERSPROFILE% is *system-drive*\ProgramData.

A *folder protected by the system* is the path to a folder in any of the following:

```
system-drive\Windows
```

```
system-drive\Program Files
```

```
system-drive\Program Files (x86)
```

For Windows, if the installation folder is other than the above:

```
JP1/AJS3 - Manager-installation-folder\backup
```

For UNIX:

```
/var/opt/jplajs2/backup/
```

Note that the directory name cannot contain spaces.

If the specified directory does not exist, the command terminates abnormally.

If the command terminates abnormally, files might remain. If files remain, delete them and then re-execute the command.

-S

Specify this option if you want to skip setup of the embedded database during migration. If you execute the command when the embedded database has already been set up, specify this option.

However, if you execute the command with this option specified when the embedded database has not been set up, the KAVS0177-E message (`Database type is invalid`) is output.

-s {l|m|s}

Use this option to specify one of the following database models:

- **l**

Specifies a large-scale system model such as shown below:

- Total number of units: About 48,000 to 240,000
- Total number of jobs and jobnets executed per day: 30,000 to 120,000
- Required disk space: About 20,700 MB

- **m**

Specifies a medium-scale system model such as shown below:

- Total number of units: About 5,000 to 48,000
- Total number of jobs and jobnets executed per day: 5,000 to 30,000
- Required disk space: About 4,200 MB

- **s**

Specifies a small-scale system model such as shown below:

- Total number of units: A maximum of about 5,000
- Total number of jobs and jobnets executed per day: A maximum of about 5,000
- Required disk space: About 520 MB

The default value for this option is **s** (small-scale model).

-u *number-of-scheduler-services-to-be-stored-in-one-database*

If you do not want to inherit the configuration existing before migration, using a decimal number specify the number of scheduler services to be stored in one database.

You can specify a value from 1 to 20. If you omit this option, the system assumes 4.

Note that if the embedded database set up in version 8 was used as the scheduler database before migration, the configuration existing before migration is inherited regardless of the specification of this option.

-r

Specify this option to set up the primary host environment in a cluster configuration. If you specify this option, you must also specify the logical host name (**-h** option).

The shared disk must be mounted on the primary host. In addition, the logical host must be accessible.

-f

Specify this option to set up the secondary host environment in a cluster configuration. If you specify this option, you must also specify the logical host name (-h option).

If this option is specified, the command performs only setup of the embedded database, and does not create data areas or start the embedded database. Note, however, that the specification of the data and system areas for the embedded database (-d option) on the secondary host must be the same as the specification in the primary host environment.

-C

Specify this option to output the current database configuration to the standard output file.

Notes

- If you are using the embedded database or HiRDB as the database for a JP1/AJS2 scheduler service, you must start the embedded database or HiRDB in advance. For details about how to start the embedded database or HiRDB, see the applicable JP1/AJS2 manual or the HiRDB manual.

- Take the following action before you execute this command with the `-convert` option specified:

In Windows, stop the JP1/AJS3 service.

In UNIX, stop the JP1/AJS3 service, and execute the `ajsshmdel` command. The `ajsshmdel` command is located in `/opt/jplajs2/bin/ajsshmdel`.

The following shows an example of executing the `ajsshmdel` command.

sh:

```
/opt/jplajs2/bin/ajsshmdel >/dev/null 2>&1
```

csh:

```
/opt/jplajs2/bin/ajsshmdel >&/dev/null
```

In UNIX, if you attempt to execute the `jajs_migrate` command without executing the `ajsshmdel` command after the JP1/AJS3 service has stopped, the KAVS0549-E message is output, and the `jajs_migrate` command terminates abnormally.

- Do not execute this command with the `-convert` option more than once in quick succession.
- Do not forcibly terminate this command when specifying the `-convert` option.
- Before you execute this command with the `-convert` option, register in the `hosts` file or DNS both the physical host name and logical host name of the JP1/AJS3 host you are migrating to the standard configuration.

Even if you specify in the `jplhosts` or `jplhosts2` definition file the names of the hosts to be migrated in the standard configuration, they are not used as the host names used for the embedded database.

Do not use an alias as the name of a host you want to migrate in the standard configuration.

The maximum length of the name of a host on which JP1/AJS3 can operate in the standard configuration is 32 bytes. Make sure that the names of the physical and logical hosts you want to migrate in the standard configuration are 1 to 32 bytes each.

- When you specify the `-convert` option, the command execution results are output to a log file. The location of the log file is as follows.

For Windows, if the installation folder is the default installation folder or is in a folder protected by the system:

```
%ALLUSERSPROFILE%\Hitachi\JP1\JP1_DEFAULT\JP1AJS2\log
```

The default value of `%ALLUSERSPROFILE%` is `system-drive\ProgramData`.

A *folder protected by the system* is the path to a folder in any of the following:

```
system-drive\Windows
```

system-drive\Program Files
system-drive\Program Files (x86)

For Windows, if the installation folder is other than the above:

JP1/AJS3 - Manager-installation-folder\log

For UNIX:

/var/opt/jplajs2/log

The file name is *jaajs_migrate_logical-host-name_N.log*, where *N* is a sequential number starting with 1.

- After you execute the *jaajs_migrate* command with the *-convert* option, check the return value of the command and the log file to make sure that setup of the standard configuration has completed normally. If the command has terminated abnormally, correct the cause of the error, and then re-execute the command.
- To set up JP1/AJS3 in the standard configuration on a physical host, make sure that the *JP1_HOSTNAME* environment variable has not been set when you execute the *jaajs_migrate* command specifying the *-convert* option. If the command is executed in an environment in which the *JP1_HOSTNAME* environment variable is set, JP1/AJS3 on the logical host specified in the *JP1_HOSTNAME* environment variable is set up in the standard configuration. If the *JP1_HOSTNAME* environment variable is set, delete it, and then execute the command.
- When you specify the *-convert* option, the command is executed on the embedded database existing before JP1/AJS3 migration. Therefore, if the embedded database is being used as the scheduler database prior to migration, add the following path to the appropriate environment variable, and then execute the command with the *-convert* option:

In HP-UX:

SHLIB_PATH=installation-directory-for-the-embedded-database-before-migration/client/lib

In Solaris or Linux:

LD_LIBRARY_PATH=installation-directory-for-the-embedded-database-before-migration/client/lib

In AIX:

LIBPATH=installation-directory-for-the-embedded-database-before-migration/client/lib

If you execute the command without adding the above path, the command outputs the KAVS0990-E message, and terminates abnormally.

- Note the following if the *jaajs_migrate -convert* command terminates abnormally and you need to re-execute the command:
 - If the *DBBKUP* directory has been created in the database directory of each scheduler service, and files have been contained in the *DBBKUP* directory, move these files to the database directory.
 - Use the *ajsembdbstatus* command with the *-sust* option specified to check the status of the embedded database used in version 8. If the status is *STOP*, use the *ajsembdbstart* command to change the status to *ONLINE*.
- When you execute this command with the *-convert* option specified, a port number in the range 22220 to 22239 is allocated automatically when the system builds the embedded database. An error occurs if the selected port number is in use. Before you execute the command, make sure that ports 22220 to 22239 are available.
- If ISAM is being used as the scheduler service database in JP1/AJS3 version 8 or earlier, at successful execution of the *jaajs_migrate -convert* command the ISAM files will be backed up to a *DBBKUP* directory created in the database directory of the scheduler service. You can delete the directory if deleting the directory causes no problem with operation.
- If the embedded database (HiRDB) is being used as the scheduler service database in JP1/AJS3 version 8 or earlier, use of HiRDB will cease at successful execution of the *jaajs_migrate -convert* command. Delete the environment, if necessary.

- If you are using a Windows firewall, a pop-up message might appear during setup processing when you execute this command with the `-convert` option specified. If a pop-up message is displayed, registration in the Windows Firewall exceptions list is required. Take action by referring to the notes on the `ajsembdbinstl` command.
- When you execute this command with the `-convert` option specified, a default execution agent and an execution agent that has the same name as the local host are both defined as execution agents on the local host.#

#:

If the execution agent that has the same name as the local host name has not been defined in version 8 or earlier, only the default execution agent is defined. The execution agent that has the same name as the local host name is not defined.

Note that the execution agent that will be selected depends on how the execution agent is specified in the unit definition:

- When specification of the execution agent is omitted in the unit definition:
The default execution agent will execute jobs.
- When the local host name is explicitly specified as the execution agent in the unit definition:
The execution agent that has the same name as the local host name will execute jobs.

Also note that the maximum number of concurrently executable jobs set for an execution agent applies only to that execution agent. If both execution agents have been defined, the maximum number of jobs that will be executed concurrently on the local host is the total of the maximum values for the two agents.

For example, if the local host name `host1` has already been defined as an agent in version 8 or earlier, executing the command will define two execution agents, `@SYSTEM` and `host1`. If the setting of the maximum number of concurrently executable jobs for `host1` is `00:00-00:00=10` (maximum of 10 jobs at any time), a maximum of 15 jobs might be executed concurrently on the local host. This is because the setting of the maximum number of concurrently executable jobs for the default execution agent is `00:00-00:00=5` (maximum of five jobs at any time).

- You can execute this command specifying the `-C` option whether JP1/AJS3 services are active or not.
- When you execute this command with the `-C` option specified, `JP1_DEFAULT` is set as the logical host in the output items even if you specified the machine name of the physical host in the `-h` option.
- If you are using an embedded DB or HiRDB as the database for the scheduler service in a JP1/AJS2 V8 environment or earlier, disable the client environment definitions of the embedded DB and/or HiRDB specified in the environment where the command is executed.

Return values

| | |
|---------------------|--------------|
| 0 | Normal end |
| Values other than 0 | Abnormal end |

Example 1

In the following example, the command sets up JP1/AJS3 in the standard configuration to create five scheduler services to be stored in one database on the physical host on which JP1/AJS3 is installed as an upgrade installation from JP1/AJS2.

```
jajs_migrate -convert -u 5
```

Example 2

The command in this example outputs the current database configuration on the logical host (`lhost`) to the standard output file.

```
jajs_migrate -h lhost -C
```

Output example

The following gives an example of file output when you specify the `-C` option, and explains what each item means.

```
Logical host  lhost  
DB construction  standard
```

The output items are as follows:

Logical host

Indicates a logical host name.

If you specified the machine name of a physical host in the `-h` option, `JP1_DEFAULT` is set here.

DB construction

Indicates the current JP1/AJS3 database configuration as one of the following:

| DB construction | Meaning |
|---------------------------|---|
| standard | The database has been migrated to the standard configuration. |
| compatible ISAM | The database has not yet been migrated to the standard configuration. The database is operating in a compatible ISAM configuration. |
| invalid (not yet shifted) | JP1/AJS3 cannot be used at present because the required migration to the standard configuration has not yet completed. |

jajs_rpenvexport

Format

```
jajs_rpenvexport
  [-h logical-host-name]
  -d output-directory-name
```

Description

The `jajs_rpenvexport` command outputs (exports) disaster recovery operation setup information for JP1/AJS3 - Manager to the specified directory.

Execution privileges

In Windows: Administrators privileges

In UNIX: Superuser privileges

Storage directory

In Windows:

JP1/AJS3 - Manager-installation-folder\bin\

In UNIX:

/opt/jp1ajs2/bin/

Arguments

-h *logical-host-name*

Specify the name of the logical host at which to export disaster recovery operation setup information for JP1/AJS3 - Manager. You can specify a character string of 1 to 32 bytes.

The value of this option overrides the value of the `JP1_HOSTNAME` environment variable. If you omit this option, the value of `JP1_HOSTNAME` is assumed. If `JP1_HOSTNAME` has not been set, the command terminates abnormally.

The command terminates abnormally if you specify a physical host name (machine name or `JP1_DEFAULT`) in this option, or if the specified logical host has not been set up (undefined definition key *logical-host-name*\JP1AJSMANAGER).

-d *output-directory-name*

Specify the full path name of the directory to which the JP1/AJS3 - Manager disaster recovery operation setup information is to be exported. The information will be stored in a directory named `jp1ajs3_rp`, which the system creates in the directory you specify here. Specify an existing directory. The command terminates abnormally if no such directory exists. Do not specify a disk on the network drive.

You can specify a character string of 1 to 185 bytes.

This option is mandatory.

If disaster recovery operation setup information already resides in the specified directory (if a `jp1ajs3_rp` directory already exists), the existing information will be deleted. If you need to keep the old information, back it up first.

Notes

- The `jajs_rpenvexport` command is incorporated into a script. For this reason, specifying an excessively long character string or an invalid character string or value in this option sometimes results in an unexpected error. Specify character strings and numeric values that are defined in JP1/AJS3.
- Before you execute this command, execute the command `jajs_rpsite` with the `-v` or `-V` option specified, and make sure that output of the message KAVS3711-E is disabled.
- Do not execute this command repeatedly in quick succession. In addition, do not execute this command at the same time and on the same logical host as the command `jajs_rpenvimport` or `jajs_rpsite`. If you do so, the following problems might occur:
 - The message output is incorrect. For example, an invalid message might be output or a message that would normally be output does not appear.
 - The command results in an error.
 - The configuration definition information becomes invalid, disabling further operation of JP1/AJS3.
 - The output JP1/AJS3 - Manager disaster recovery operation setup information is incorrect.
- Do not forcibly terminate this command during execution.
- The command sometimes ends normally even if the environment is invalid. If this occurs, JP1/AJS3 - Manager will not operate correctly on the host that the acquired disaster recovery operation setup information is imported to. Before you export disaster recovery operation setup information, make sure that the environment is operating normally.
- You cannot specify the following characters in the command arguments:

In Windows:

```
^ & = ! @ ~ % " < > | , ; * ?
```

In UNIX:

```
^ & = ! @ ~ % " < > | , ; * ? \ ' $
```

Actions to be taken if an error occurs

Remove the cause of the error as indicated in the message, and then re-execute the command.

See also the cause and action information in the following table where applicable.

| Message | Cause | Action to be taken |
|--|--|---|
| KAVS1111-E This function cannot be used with the compatible ISAM configuration. | The JP1/AJS3 database is not the standard configuration. (For example, the database is being migrated, or the embedded database has not been created.) | Check the database configuration of the logical host specified in the <code>-h</code> option. |

Return values

| | |
|---------------------|--------------|
| 0 | Normal end |
| Values other than 0 | Abnormal end |

Example

The command in this example exports disaster recovery operation setup information to the following directory in logical host (LHOST1).

```
c:\temp\export\ajs3_rpenv_20100801
```

```
jajs_rpenvexport -h LHOST1 -d c:\temp\export\ajs3_rpenv_20100801
```

jajs_rpenvimport

Format

```
jajs_rpenvimport
  [-h logical-host-name]
  -e physical-host-name-of-primary-node
  -d input-directory-name
  [-s]
```

Description

The `jajs_rpenvimport` command reads (imports) the JP1/AJS3 - Manager disaster recovery operation setup information exported by the `jajs_rpenvexport` command and sets the JP1/AJS3 - Manager environment information.

Execution privileges

In Windows: Administrators privileges

In UNIX: Superuser privileges

Storage directory

In Windows:

JP1/AJS3 - Manager-installation-folder\bin\

In UNIX:

/opt/jp1ajs2/bin/

Arguments

-h *logical-host-name*

Specify the name of the logical host at which to import disaster recovery operation setup information exported by the `jajs_rpenvexport` command. You can specify a character string of 1 to 32 bytes.

The value of this option overrides the value of the `JP1_HOSTNAME` environment variable. If you omit this option, the value of `JP1_HOSTNAME` is assumed. If `JP1_HOSTNAME` has not been set, the command terminates abnormally.

The command terminates abnormally if you specify a physical host name (machine name or `JP1_DEFAULT`) in this option.

-e *physical-host-name-of-primary-node*

Specify the host name (output by the `hostname` command) recognized as the TCP/IP host name by the operating system on the primary node at the remote site. You can specify a character string of 1 to 63 bytes. This option is mandatory.

-d *input-directory-name*

Specify the full path name of the directory containing the disaster recovery operation setup information exported by the `jajs_rpenvexport` command. Specify the directory in which the `jp1ajs3_rp` directory containing the exported information resides. The command terminates abnormally if no such directory exists. Do not specify a disk on the network drive.

You can specify a character string of 1 to 185 bytes.

This option is mandatory.

The command terminates abnormally if no disaster recovery operation setup information exists in the specified directory.

-s

This option forcibly overwrites the existing JP1/AJS3 - Manager environment information even if the logical host specified in the `-h` option has been set up (that is, the definition key *logical-host-name*\JP1AJSMANAGER is defined).

If you omit this option and the logical host has been set up, a response-required message asks for confirmation that you want to overwrite the JP1/AJS3 - Manager environment information.

Notes

- To execute this command, the embedded database used by the logical host specified in the `-h` option must be installed. If the embedded database is not installed, the command terminates abnormally.
Use the `ajsembdbidlist` command to check whether the embedded database used by the logical host specified in the `-h` option is installed. For details on this command, see *ajsembdbidlist* in 2. *Commands Used during Setup*.
- To execute this command, all JP1/AJS3 - Manager services at the logical host specified in the `-h` option must be stopped; otherwise, the command terminates abnormally.
Use the `jajs_spmd_status` command to check whether all JP1/AJS3 - Manager services at the logical host specified in the `-h` option have stopped. For details on this command, see *jajs_spmd_status* in 3. *Commands Used for Normal Operations*.
To check whether the embedded database has stopped, use the `ajsembdbstatus` command. For the command syntax, see *ajsembdbstatus* in 3. *Commands Used for Normal Operations*.
- The command terminates abnormally if the system status of the embedded database is *restart suspended*. Make sure that the embedded database used by the logical host specified in the `-h` option has stopped. To release the *restart suspended* status of the embedded database, execute the `ajsembdbstart` command with the `-Rf` option specified. For details on this command, see *ajsembdbstatus* in 3. *Commands Used for Normal Operations* or *ajsembdbstart* in 3. *Commands Used for Normal Operations*.
- The `jajs_rpenvimport` command is incorporated into a script. For this reason, specifying an excessively long character string or an invalid character string or value in this option sometimes results in an unexpected error. Specify character strings and numeric values that are defined in JP1/AJS3.
- Before you execute this command, execute the command `jajs_rpsite` with the `-v` or `-V` option specified, and make sure that output of the message KAVS3711-E is disabled.
- Do not execute this command repeatedly in quick succession. In addition, do not execute this command at the same time and on the same logical host as the command `jajs_rpenvexport` or `jajs_rpsite`. If you do so, the following problems might occur:
 - The message output is incorrect. For example, an invalid message might be output or a message that would normally be output does not appear.
 - The command results in an error.
 - The configuration definition information becomes invalid, disabling further operation of JP1/AJS3.
- Do not forcibly terminate this command during execution.
- You cannot specify the following characters in the command arguments:

In Windows:

`^ & = ! @ ~ % " < > | , ; * ?`

In UNIX:

`^ & = ! @ ~ % " < > | , ; * ? \ ' $`

- An error might occur when you execute this command in conjunction with the `jajs_spm�_status` command. If so, re-execute the commands.
- This command converts the environment parameter set in the export source host to the logical host name specified in the `-h` option.

The definition keys and environment setting parameters in the table below must be unique in the physical host and among all logical hosts. Before you execute this command, make sure that the definition keys and parameters are not duplicated on the logical host of the import destination or on any other logical hosts or physical hosts.

| Definition key | Environment setting parameters | Definition |
|---|--------------------------------|---|
| AJSMANAGER\ <i>scheduler-service-name</i> | -- | The name of the scheduler service |
| | AJSSERVICEID | The scheduler service identification number |
| | JOBSTATUSPORT | The service name of the port used to acquire the job status |
| | RDBPORT | RDB port number |
| | AJSTMPDIR | The name of the directory for temporary files |
| | JOBINFDIR | The name of the directory for job error information |
| | AJSDBDIRECTORY | The name of the database directory |

- If you specified the `-bl` option in the `ajsembdbbuild` command when building the embedded database environment at the main site, the directory you specified in the `-bl` option will be created at the import destination host.
- If the shared disk is unreachable when you execute this command, the following message might be output to the integrated trace log: `KNAD3914-E An attempt to open the lock file under the conf directory has failed.` However, the import processing completes normally.
- In a cluster configuration, execute this command on both the primary and secondary nodes. On both nodes, specify the physical host name of the primary node for the `-e` option.

Actions to be taken if an error occurs

Remove the cause of the error as indicated in the message, and then re-execute the command.

See also the cause and action information in the following table where applicable.

| Message | Cause | Action to be taken |
|--|---|--|
| KAVS1111-E This function cannot be used with the compatible ISAM configuration. | The JP1/AJS3 database is not the standard configuration. (For example, the database is being migrated, or the embedded database has not been created.) | Check the database configuration of the logical host specified in the <code>-h</code> option. |
| KAVS1112-E The specified directory (<i>directory-name</i>) does not exist. | The directory specified in the <code>-d</code> option does not contain the <code>jplajs3_rp</code> directory exported by the <code>jajs_rpenvexport</code> command. | Re-execute the command, specifying the correct directory name (including the <code>jplajs3_rp</code> directory) exported by the <code>jajs_rpenvexport</code> command. |

Return values

| | |
|---------------------|--------------|
| 0 | Normal end |
| Values other than 0 | Abnormal end |

Example

The command in this example imports disaster recovery operation setup information stored in the following directory into the logical host LHOST1 (primary node physical host: PHOST).

```
c:\temp\export\ajs3_rpenv_20100801
jajs_rpenvimport -h LHOST1 -e PHOST -d c:\temp\export\ajs3_rpenv_20100801
```

jajs_rpsite

Format

```
jajs_rpsite
  [-h logical-host-name]
  [-m {SET|SETSAME|CHANGE|UNSET} | -v | -V]
```

Description

The `jajs_rpsite` command sets up JP1/AJS3 for operation in disaster recovery mode using the disk copy and mirroring functionality of the hardware.

The following processing can be performed according to the specified option:

- Set up a new logical host to operate as the main site
- Change the logical host that operates as the main site
- Exit disaster recovery mode
- Display the name of the logical host operating as the main site
- Display whether the site is the main site or remote site

You can execute this command only in the standard configuration.

Execution privileges

In Windows: Administrators privileges

In UNIX: Superuser privileges

Arguments

-h *logical-host-name*

Specify the target logical host name. You can specify a character string of 1 to 32 bytes.

The value of this option overrides the value of the `JP1_HOSTNAME` environment variable.

The command terminates abnormally if you specify a physical host name (machine name or `JP1_DEFAULT`) in this option.

If you omit this option and the `JP1_HOSTNAME` environment variable has not been set, the physical host name is assumed and the command terminates abnormally.

The command terminates abnormally if the specified logical host does not exist at the site where you executed the command.

-m { **SET** | **SETSAME** | **CHANGE** | **UNSET** }

- SET

Sets up a new logical host to be used as the main site when operation in disaster recovery mode is to be configured by using logical hosts with different names.

JP1/AJS3 services at the remote site are deactivated when you have set up a logical host as the main site, and have started operation at the main site and copying between the shared disks.

Specify this option to set up a new logical host to operate as the main site. If the logical host to be used as the main site is already set, the command terminates abnormally regardless of whether that logical host was set by using `-m SET` or `-m SETSAME`.

The command terminates abnormally if you specify the `-m SET` option with the `-v` or `-V` option.

If processing ends normally, message KAVS3707-I is output.

- SETSAME

Sets up a new logical host to be used as the main site when operation in disaster recovery mode is to be configured by using logical hosts with the same name.

JP1/AJS3 services at the remote site are deactivated when you have set up a logical host as the main site, and have started operation at the main site and copying between the shared disks.

Specify this option to set up a new logical host to operate as the main site. If the logical host to be used as the main site is already set, the command terminates abnormally regardless of whether that logical host was set by using `-m SET` or `-m SETSAME`.

The command terminates abnormally if you specify the `-m SETNAME` option with the `-v` or `-V` option.

If processing ends normally, message KAVS3710-I is output.

- CHANGE

Changes the logical host that operates as the main site in disaster recovery mode.

Specify this option to switch operation to the remote site and resume job processing when a disaster at the main site causes the system to go down.

When you change the logical host that operates as the main site, JP1/AJS3 services are reactivated at the logical host you have designated, and are suppressed at the logical host which now serves as the remote site.

The command terminates abnormally if:

- The logical host to operate as the main site has not been configured.
- The name of the logical host already operating as the main site is specified during the configuration of operation in disaster recovery mode by using logical hosts with different names.
- Commands are executed on the logical host already operating as the main site during the configuration of operation in disaster recovery mode by using logical hosts with the same name.
- You specify this option with the `-v` or `-V` option.
- Switching operation to the remote site fails.

If processing ends normally, message KAVS3708-I is output.

- UNSET

Exits disaster recovery mode.

Take JP1/AJS3 out of disaster recovery mode at both the main site and remote site. JP1/AJS3 services remain deactivated at the remote site until disaster recovery mode is released.

The command terminates abnormally if you specify the `-m UNSET` option with the `-v` or `-V` option.

If processing ends normally, message KAVS3709-I is output.

-v

Displays the name of the logical host currently operating as the main site in disaster recovery mode.

The command terminates abnormally if you have not configured a logical host to serve as the main site in disaster recovery mode.

The command terminates abnormally if you specify the `-v` option with the `-m` or `-V` option.

-v

Displays whether the specified logical host is currently serving as the main site (Main is displayed) or the remote site (Remote is displayed).

The command terminates abnormally if you have not configured a logical host to serve as the main site in disaster recovery mode.

The command terminates abnormally if you specify the -v option with the -m or -v option.

Notes

- Before you start copying between the shared disks by means of the hardware functions, make sure that you specify the -m SET or -m SETNAME option to configure the logical host that will operate as the main site. If you do not designate the logical host that is to operate as the main site, JP1/AJS3 services will not be deactivated at the remote site.
- Do not execute the `jajs_rpsite` command repeatedly in quick succession. In addition, do not execute this command at the same time and on the same logical host as the command `jajs_rpenvexport`, `jajs_rpenvimport`, or `jajs_spmd`. If you do so, the following problems might occur:
 - The message output is incorrect. For example, an invalid message might be output or a message that would normally be output does not appear.
 - The `jajs_rpsite` command results in an error.
 - The configuration definition information becomes invalid, disabling further operation of JP1/AJS3.
- Before you execute the -m SET, -m SETNAME, -m CHANGE, or -m UNSET option, stop disk copying by hardware functions between the shared disks.
- If you execute the -m SET, -m SETNAME, or -m CHANGE option at the main site while information is being copied from the main site to the remote site, the command will end abnormally because the logical host that is to operate as the main site has already been specified.
- Execute the -m SET, -m SETNAME, and -m CHANGE options at the site that is to operate as the main site.
- Execute the -m UNSET options at both the main site and remote site.
- After executing the command `jajs_rpsite` with the option -m SET, -m SETSAME, or -m UNSET, check whether the settings for operation in disaster recovery mode were correctly specified or removed. To check this, execute the command `jajs_rpsite` with the -v or -V option.
- If you execute this command at the remote site while information is being copied from the main site to the remote site, the shared disks cannot be accessed and the command will end abnormally.
- The command terminates abnormally if the shared disks of the logical hosts are not mounted.
- To reconfigure operation in disaster recovery mode, remove the settings for operation in disaster recovery mode by using the option -m UNSET, and then respecify the settings by using the option -m SET or -m SETSAME.

Return values

| | |
|---------------------|--------------|
| 0 | Normal end |
| Values other than 0 | Abnormal end |

Example

The following examples show operation in disaster recovery mode, using the disk copy and mirroring functionality of the hardware.

Example 1

In the following example, logical hosts are configured by using different names, and LHOST_M is specified for the main-site logical host.

```
jajs_rpsite -h LHOST_M -m SET
```

Example 2

In the following example, logical hosts are configured by using the same name, and LHOST_M is specified for the main-site logical host.

```
jajs_rpsite -h LHOST_M -m SETSAME
```

Example 3

In the following example, logical hosts are configured by using different names, and the main-site logical host switches to LHOST_R (which is currently operating as the remote site) during failover.

```
jajs_rpsite -h LHOST_R -m CHANGE
```

Example 4

In the following example, logical hosts are configured by using the same name, and the main-site logical host switches to LHOST_M (which is currently operating as the remote site) during failover.

```
jajs_rpsite -h LHOST_M -m CHANGE
```

Example 5

Display the name of the logical host currently operating as the main site in the following configuration:

- Main site: Logical host (LHOST_M)
- Remote site: Logical host (LHOST_R)

```
jajs_rpsite -h LHOST_M -v
```

or

```
jajs_rpsite -h LHOST_R -v
```

Example 6

In the examples below, the command displays whether each specified logical host is currently operating as the main site or as the remote site, where the main site and remote site are as follows:

- Main site: Logical host (LHOST_M)
- Remote site: Logical host (LHOST_R)

```
jajs_rpsite -h LHOST_M -V
```

or

```
jajs_rpsite -h LHOST_R -V
```

Example 7

Exit disaster recovery mode in the following configuration:

- Main site: Logical host (LHOST_M)
- Remote site: Logical host (LHOST_R)

```
jajs_rpsite -h LHOST_M -m UNSET
```

and

```
jajs_rpsite -h LHOST_R -m UNSET
```

Output example 1

The following shows an output example when you specify the `-v` option to display the name of the logical host currently operating as the main site:

```
> jajs_rpsite -h LHOST_M -v  
LHOST_R
```

Output example 2

The following examples show the output when the `-V` option is specified to display whether the specified logical host is currently operating as the main site or the remote site:

```
> jajs_rpsite -h LHOST_M -V  
Main  
  
> jajs_rpsite -h LHOST_R -V  
Remote
```

jajs_setup

Format

```
jajs_setup
  {[-F scheduler-service-name] | [-G]}
  {-a
  [-h logical-host-name]
  -n scheduler-service-ID-number
  -p service-for-the-port-reporting-the-job-status
  -d database-directory-name
  -t temporary-directory-name
  -j job-information-directory-name
  -b backup-information-directory-name
  [-D logical-host-shared-directory-name]
  [-k {EmbedDB | SQLSVR}]
  [-of ODBC-file-data-source-name -od database-name]
  [[-I setup-identifier
  -P embedded-database-port-number]
  [-M {s|m|l}]
  [-E {byte | sjis}]
  [-B]] |
  [-S] |
  -r -A new-scheduler-service-name |
  -e}
```

Format 1 (for adding a scheduler service whose database type is embedded database)

```
jajs_setup
  -a
  [-h logical-host-name]
  [-F scheduler-service-name]
  -n scheduler-service-ID-number
  -p service-for-the-port-reporting-the-job-status
  -d database-directory-name
  -t temporary-directory-name
  -j job-information-directory-name
  -b backup-information-directory-name
  [-D logical-host-shared-directory-name]
  [-k EmbedDB]
  [[I setup-identifier
  -P embedded-database-port-number]
  [-M {s|m|l}]
  [-E {byte | sjis}]
  [-B]] |
  -S]
```

Format 2 (for adding a scheduler service whose database type is external database)

```
jajs_setup
  -a
  -k SQLSVR
  [-h JP1_DEFAULT]
  [-F scheduler-service-name]
  -n scheduler-service-ID-number
  -p service-for-the-port-reporting-the-job-status
```

```
-d database-directory-name
-t temporary-directory-name
-j job-information-directory-name
-b backup-information-directory-name
-of ODBC-file-data-source-name
-od database-name
[-E {byte | sjis}]
```

Format 3 (for setting up information about an execution agent when the database type is external database)

```
jajs_setup
-a
-k SQLSVR
[-h JP1_DEFAULT]
-G
-of ODBC-file-data-source-name
-od database-name
```

Format 4 (for renaming a scheduler service)

```
jajs_setup
-r
[-F scheduler-service-name]
-A new-scheduler-service-name
```

Format 5 (for deleting a scheduler service)

```
jajs_setup
-e
[-F scheduler-service-name]
```

Description

The `jajs_setup` command performs setup of JP1/AJS3 scheduler services.

The following setup operations can be performed according to the specified option:

- Adding a scheduler service
- Renaming a scheduler service
- Deleting a scheduler service
- Setting up execution agent information when an external database is used to operate JP1/AJS3

Execution privileges

In Windows: Administrators privileges

In UNIX: Superuser privilege

Arguments

-a

Specify this option to add a new scheduler service or set up execution agent information.

When this command is used to add a new scheduler service whose database is embedded, the command also installs and sets up the database for the new scheduler service. You can use this command to create a new scheduler service easily.

After a scheduler service has been added normally, if you want to change an environment setting parameter for the scheduler service, execute the `jaajs_config` command by specifying the following value for the `-k` option (definition key):

```
[ {JP1_DEFAULT|logical-host}#1\JP1AJSMANAGER\scheduler-service#2]
```

#1

The specification of the `{JP1_DEFAULT|logical-host}` part depends on whether the host is a physical host or a logical host. For a physical host, specify `JP1_DEFAULT`. For a logical host, specify the logical host name.

#2

Specify the name of the new scheduler service you created.

You must specify this option with the `-h`, `-F`, `-G`, `-n`, `-p`, `-d`, `-t`, `-j`, `-b`, `-k`, `-of`, `-od`, `-I`, `-P`, `-M`, `-B`, and `-S` options. If you add a scheduler service to a logical host, you must also specify the `-D` option.

If you specify this option to add a scheduler service, you cannot omit the, `-n`, `-p`, `-d`, `-t`, `-j`, and `-b` options.

If you add a scheduler service to a logical host, you cannot omit the `-D`, `-I`, and `-P` options.

If a new embedded database needs to be created, the command execution requires several tens of minutes. For a physical host, if the `-I` and `-P` options are omitted, the maximum number of scheduler services that can be created in an embedded database is four. If you create more than four scheduler services, another embedded database will need to be created and the command might take a long time to execute. When the `-I` option is specified, a scheduler service is created for the specified embedded database. Unless the setup identifier for a pre-configured embedded database is specified in the `-I` option, a new embedded database will need to be created and the command might take a long time to execute.

Note that a maximum of four scheduler services are created for one embedded database even if the `-u` option was specified for the `jaajs_migrate` command. If you want to specify the number of scheduler services created for one embedded database, use advanced setup of an embedded database. For details about the `jaajs_migrate` command, see *jaajs_migrate* in [2. Commands Used during Setup](#) in this chapter. For details about advanced setup of an embedded database, see [23.4 Advanced setup of an embedded database](#) in the *JP1/Automatic Job Management System 3 Configuration Guide*.

-r

Specify this option to rename a scheduler service. The command renames a scheduler service on the host on which the command is executed regardless of whether the host is a physical host or a logical host.

You must specify this option with the `-F` and `-A` options. The `-A` option cannot be omitted.

Renaming of a scheduler service affects JP1/AJS3 functions. For example, a unit might terminate abnormally or might not operate correctly if a scheduler service is renamed after operation has started. Therefore, we recommend that you rename a scheduler service before operation starts.

You cannot use this option to change only the case (uppercase/lowercase) of characters in a scheduler service name. To change only the case of a scheduler service name, first change the scheduler service name provisionally and then change the case.

For the procedure for renaming a scheduler service, see the following sections:

In Windows:

- In a non-cluster environment
6.1.1(4) Renaming a scheduler service in the JP1/Automatic Job Management System 3 Configuration Guide
- In a cluster environment
8.2.10(4) Renaming a scheduler service in the JP1/Automatic Job Management System 3 Configuration Guide

In UNIX:

- In a non-cluster environment
15.1.1(4) Renaming a scheduler service in the JP1/Automatic Job Management System 3 Configuration Guide
- In a cluster environment
17.2.10(4) Renaming a scheduler service in the JP1/Automatic Job Management System 3 Configuration Guide

-e

Specify this option to delete a scheduler service. The command deletes a scheduler service on the host on which the command is executed regardless of whether the host is a physical host or a logical host.

When a scheduler service is deleted by this command, the scheduler database for the scheduler service is also deleted.

For details about the procedure for deleting a scheduler service in a logical host environment, see *8.2.10(2) Deleting an added scheduler service in the JP1/Automatic Job Management System 3 Configuration Guide* (for Windows) or see *17.2.10(2) Deleting an added scheduler service in the JP1/Automatic Job Management System 3 Configuration Guide* (for UNIX).

You must specify this option with the **-F** options.

-h *logical-host-name*

Specify the name of the logical host on which to set up the scheduler service.

You can specify a character string of 1 to 32 bytes.

The setup will be performed on the logical host specified in this option.

The value of this option overrides the value of the `JP1_HOSTNAME` environment variable. If you omit this option, the value of `JP1_HOSTNAME` is assumed as the logical host name.

When setting up a scheduler service for a physical host, you can specify the physical host name in either of the following ways:

- Omit the **-h** option and do not set the `JP1_HOSTNAME` environment variable.
- Specify `JP1_DEFAULT` as the value of the **-h** option or the value of the `JP1_HOSTNAME` environment variable.

You cannot set a physical host name by specifying a machine name in the **-h** option or in the `JP1_HOSTNAME` environment variable.

If you are setting up the scheduler service on a logical host, you must also specify the **-D**, **-I**, and **-P** options.

If you specify both the **-r** and **-e** options and omit the **-h** option, the physical host is assumed. You cannot specify this option with the **-r** and **-e** option.

-F scheduler-service-name

Specify the name of the scheduler service for which you want to perform the desired operation (addition, renaming, or deletion).

You can specify a character string of 1 to 30 bytes.

For the characters you can specify in a scheduler service name, see the note about scheduler services under *Table 20-2 Environment setting parameters (scheduler service environment setup)* in *20.4 Setting up the scheduler service environment* in the *JP1/Automatic Job Management System 3 Configuration Guide*.

If you omit this option, the system assumes the default scheduler service name.

This option cannot be specified together with the **-G** option.

-G

Specify this option to set up information about an execution agent if you are using an external database to operate JP1/AJS3.

This option can be specified in Windows or Linux, but it cannot be specified in AIX, HP-UX, or Solaris.

You must specify this option with the **-a** and **-k SQLSVR** options.

You cannot specify this option with the **-F**, **-n**, **-p**, **-d**, **-t**, **-j**, **-b**, **-D**, **-I**, **-P**, **-M**, **-E**, **-B**, and **-S** options.

You cannot specify this option to set up a logical host.

-A new-scheduler-service-name

Specify the new scheduler service name that will be used for the renamed scheduler service.

You can specify a character string of 1 to 30 bytes.

You must specify this option with the **-r** options.

-n scheduler-service-ID-number

Specify a decimal number as the scheduler service ID number.

You can specify a value from 1 to 20.

The command outputs a message and terminates abnormally in the following cases:

- When the specified value is outside the valid range
- When the specified ID number is already used by the physical host or any logical host of the local host

You must specify this option with the **-a** options.

Make sure that the ID number you specify is not used by the physical host or any logical host of the local host.

The ID number specified in the **-n** option is used to internally identify a scheduler service as the name of a temporary file or as an inter-process communication key. Therefore, we recommend that you do not change an ID number after you have specified it. If you change an ID number, always cold-start the scheduler service.

This option cannot be specified together with the **-G** option.

-p *service-for-the-port-reporting-the-job-status*

Specify the communication port number to be used for acquiring job status information by the service name. When the `jajs_setup` command has completed, define the service name specified in this option in the `services` file.

You can specify a character string of 1 to 31 bytes.

The command displays a message and terminates abnormally in the following cases:

- When the specified value is outside the valid range
- When startup of multiple scheduler services is enabled, the names of the scheduler services are different but port numbers defined in the `services` file are duplicate

You must specify this option with the `-a` options.

This option cannot be specified together with the `-G` option.

-d *database-directory-name*

Specify the full path name of the directory that will contain JP1/AJS3 unit information.

The directory name specified in this option, is specified for the `AJSDBDIRECTORY` environment setting parameter.

You can specify a character string of 1 to 191 bytes.

Make sure that you do not add a path separator (`\` in Windows, `/` in UNIX) at the end of the database directory name you specify.

The command displays a message and terminates abnormally in the following cases:

- When the specified value is outside the valid range
- When the specified directory does not exist
- When the specified directory name is already used as the name of a database directory on the physical host or any logical host of the local host
- When the specified database directory name ends with a path separator
- When the root directory (`/`) is specified in UNIX
- When characters other than the drive letter (for example, `C :`) are specified in the first two bytes of the character string in Windows

You must specify this option with the `-a` options.

This option cannot be specified together with the `-G` option.

-t *temporary-directory-name*

Specify the full path name of the directory in which JP1/AJS3 temporary files will be created.

You can specify a character string of 1 to 191 bytes.

If the specified directory does not exist, a warning message is displayed. Manually create the directory indicated in the warning message or use the `jajs_config` command to update the value of the `AJSTMPDIR` environment setting parameter. For the definition key to be specified in the `jajs_config` command, see the description of the `-a` option.

The command displays a message and terminates abnormally in the following cases:

- When the specified value is outside the valid range
- When the specified directory name is already used as the name of a temporary directory on the physical host or any logical host of the local host
- When the root directory (/) is specified in UNIX
- When characters other than the drive letter (for example, C :) are specified in the first two bytes of the character string in Windows

You must specify this option with the `-a` options.

This option cannot be specified together with the `-G` option.

`-j` *job-information-directory-name*

To use an embedded database, specify the full path name of the directory that will store the standard error output file during job execution if the standard error output file is not specified during job definition.

To use an external database, specify the full path name of the directory in which job information work files will be created.

You can specify a character string of 1 to 191 bytes.

If the specified directory does not exist, a warning message is displayed. Manually create the directory indicated in the warning message or use the `jajs_config` command to update the value of the `JOBINFDIR` environment setting parameter. For the definition key to be specified in the `jajs_config` command, see the description of the `-a` option.

The command displays a message and terminates abnormally in the following cases:

- When the specified value is outside the valid range
- When the specified directory name is already used as the name of a job information directory on the physical host or any logical host of the local host
- When the root directory (/) is specified in UNIX
- When characters other than the drive letter (for example, C :) are specified in the first two bytes of the character string in Windows

You must specify this option with the `-a` options.

This option cannot be specified together with the `-G` option.

`-b` *backup-information-directory-name*

Specify the full path name of the directory used for backing up units.

You can specify a character string of 1 to 191 bytes.

If the specified directory does not exist, a warning message is displayed. Manually create the directory indicated in the warning message or use the `jajs_config` command to update the value of the `AJSBKUROOT` environment setting parameter. For the definition key to be specified in the `jajs_config` command, see the description of the `-a` option.

The command displays a message and terminates abnormally in the following cases:

- When the specified value is outside the valid range
- When the root directory (/) is specified in UNIX

- When characters other than the drive letter (for example, C :) are specified in the first two bytes of the character string in Windows

You must specify this option with the `-a` options.

When the scheduler service reference restriction function is enabled (the `HIDEOTHERSERVICE` environment setting parameter is set to `yes`), specify a separate directory for each scheduler service as the backup information directory for that scheduler service. If the backup information directory is shared by multiple scheduler services, any user with access privileges to any of the scheduler services can access all of the backup information stored in the common backup information directory.

This option cannot be specified together with the `-G` option.

`-D` *logical-host-shared-directory-name*

Specify the full path name of the directory shared by logical hosts when you add a scheduler service to a logical host. For the name of the directory shared by logical hosts, specify the same shared directory name that was specified in the `-d` option of the `jajs_setup_cluster` command when the target logical hosts were created.

You can specify a character string of 1 to 165 bytes.

The command displays a message and terminates abnormally in the following cases:

- When the specified value is outside the valid range
- When the specified directory does not exist
- When the root directory (/) is specified in UNIX
- When characters other than the drive letter (for example, C :) are specified in the first two bytes of the character string in Windows

You must specify this option with the `-a` options.

You cannot specify this option with the `-G`, `-k` `SQLSVR`, `-of`, and `-od` options.

Always specify this option when you add a scheduler service to a logical host. If this option is omitted, the command terminates abnormally.

`-k` {EmbedDB | `SQLSVR`}

Specify the database type to be used. If you omit this option, the system assumes `EmbedDB`.

This option can be specified in Windows or Linux, but it cannot be specified in AIX, HP-UX, or Solaris.

You must specify this option with the `-a` options.

- `EmbedDB`
An embedded database is used.
You cannot specify this value at the same time as the `-G`, `-of` and `-od` options.
- `SQLSVR`
An external database is used.
You cannot specify this value at the same time as the `-D`, `-I`, `-P`, `-M`, `-B`, and `-S` options.
You cannot specify this value to set up a logical host.

The same database type must be used on the same host. The command terminates abnormally if any of the following database types differ from their specified value:

- Scheduler database
- Agent management database

-of *ODBC-file-data-source-name*

To use an external database, specify the full path name of the ODBC file data source (the file name of a File DSN).

You cannot specify a network drive.

The number of characters that can be specified is as follows:

- In Windows:
A character string of 1 to 255 bytes
- In Linux:
A character string of 1 to 128 bytes

You can specify the following characters:

- Alphanumeric characters
- Symbols
For Windows: (\), (:), (.)
For UNIX: (/), (.)

You cannot specify a value that contains a space.

This option can be specified in Windows or Linux, but it cannot be specified in AIX, HP-UX, or Solaris.

You must specify this option with the `-a` and `-k` `SQLSVR` options.

You cannot specify this option with the `-D`, `-I`, `-P`, `-M`, `-B`, and `-S` options.

You cannot specify this option to set up a logical host.

You must specify this option if you are using an external database.

The command terminates abnormally if the ODBC file data source specified in this option does not exist.

-od *database-name*

To use an external database, specify its name. You must specify this option if you are using an external database.

You can specify a character string of 1 to 127 bytes. However, you can specify single-byte alphanumeric characters only.

This option can be specified in Windows or Linux, but it cannot be specified in AIX, HP-UX, or Solaris.

You must specify this option with the `-a` and `-k` `SQLSVR` options.

You cannot specify this option with the `-D`, `-I`, `-P`, `-M`, `-B`, and `-S` options.

You cannot specify this option to set up a logical host.

You must specify this option when using an external database.

The command terminates abnormally if the external database specified in this option does not exist.

-I *setup-identifier*

Specify `_JFn` (n : 0 to 9 or A to Z) as the four-character setup identifier of the embedded database used on the logical host.

To set up a scheduler database in an embedded database that you have already configured, specify the setup identifier of the pre-configured database in this option. If you do not specify the setup identifier of the pre-configured embedded database, a new embedded database is configured with the setup identifier specified in the `-I` option.

If you did not specify the setup identifier of the pre-configured embedded database on a logical host, set up the embedded database on a secondary node.

If you did not specify the setup identifier of the pre-configured embedded database, the embedded database data area is created in the following applicable directory.

In Windows:

Physical host:

`JP1/AJS3-installation-folder\embdb\setup-identifier\dbarea`

Logical host:

`shared-folder\jplajs2\embdb\setup-identifier\dbarea`

In UNIX:

Physical host:

`/var/opt/jplajs2/embdb/setup-identifier/dbarea`

Logical host:

`shared-directory/jplajs2/embdb/setup-identifier/dbarea`

You must specify this option with the `-a` options.

You cannot specify this option with the `-G`, `-k SQLSVR`, `-of`, and `-od` options.

Always specify this option when you add a scheduler service to a logical host. If this option is omitted, the command terminates abnormally.

-P *embedded-database-port-number*

Specify the port number used for the embedded database.

To create a new scheduler database in an embedded database that you have already configured, specify the port number of the embedded database specified by the setup identifier in the `-I` option. If you are creating a new embedded database in which to set up the scheduler database, specify a port number that is not being used in the system.

You can specify a value from 5001 to 65535.

You must specify this option with the `-a` options.

You cannot specify this option with the `-G`, `-k SQLSVR`, `-of`, and `-od` options.

Always specify this option when you add a scheduler service to a logical host. If this option is omitted, the command terminates abnormally.

-M {s|m|l}

Specify the database model of the embedded database to be configured.

For details about the database model and disk requirements, see *23.2 Estimating the database area* in the *JPI/Automatic Job Management System 3 Configuration Guide*.

If you configure the embedded database with `l` specified in this option, the auto-increment function of the embedded database is disabled. If you want to use this function, perform an advanced setup.

When an embedded database configured with the setup identifier specified in the `-I` option exists, only the re-use start point of the free area in the embedded database is set. In this case, if the `-M` option is omitted, the database model of the embedded database in the installation directory is assumed. If the embedded database in the installation directory was configured in JPI/AJS3 version 09-50 or earlier, `s` is assumed.

If the embedded database configured with the setup identifier specified in the `-I` option does not exist, a new embedded database is set up with the specified model. If you omit this option, the system assumes `s`.

You must specify this option with the `-a` option.

You cannot specify this option with the `-S` option.

You cannot specify this option with the `-G`, `-k SQLSVR`, `-of`, `-od`, and `-S` options.

-E {byte|sjis}

Specifies for the database of the specified scheduler service whether the same number of characters can be specified for items such as a unit name in both Shift-JIS and UTF-8 environments. If you omit this option, the system assumes `byte`.

This option can be specified in UNIX, and cannot be specified in Windows.

You must specify this option with the `-a` option.

You cannot specify this option with the `-G` and `-S` option.

- `byte`

The database is set up so that the number of characters specifiable in a UTF-8 environment becomes the number of characters specified after conversion in UTF-8. If this option is specified, the number of characters specifiable for items such as a unit name in a Shift-JIS environment and a UTF-8 environment will not be the same.

If you execute the command with this option specified, `byte` is specified for the `DEFLENTYPE` environment setting parameter.

- `sjis`

The database is set up so that the number of characters specifiable in a UTF-8 environment is converted to the number of characters specifiable in a Shift-JIS environment. If this option is specified, the number of characters that can be used in the definition items for a unit in the UTF-8 environment is the same as that in the Shift-JIS environment.

This setting applies to the following items:

- **Unit name** in the detailed unit definition
- **Comment** in the detailed unit definition
- **Exclusive jobnet** in the schedule settings

If you execute the command with this option specified, `sjis` is specified for the `DEFLENTYPE` environment setting parameter and `UTF-8` is specified for the `AJSCHARCODE` environment setting parameter.

-B

Specify this option to enable the backup enhancement function when an embedded database is used. If you omit this option, the backup enhancement function is not enabled.

You must specify this option with the `-a` option.

You cannot specify this option with the `-G`, `-k SQLSVR`, `-of`, and `-od` options.

-S

Specify this option to set up an embedded database separately by performing an advanced setup instead of setting up the embedded database by using the regular method. When the command with this option specified ends normally, always perform advanced setup to complete setup of the embedded database.

For details about setting up the embedded database by performing an advanced setup, see *23.5 Advanced setup for the embedded database (in a cluster configuration)* in the *JP1/Automatic Job Management System 3 Configuration Guide*.

You must specify this option with the `-a` option.

You cannot specify this option with the `-G`, `-k SQLSVR`, `-of`, `-od`, `-E`, `-I`, `-P`, and `-M` options.

Notes

- Do not execute this command more than once in quick succession.
- Do not terminate the command forcibly.
- Before you use this command to add or delete a scheduler service whose database embedded, you must place all the embedded databases configured in the target host in running status. If you execute the command without checking the status, the command might terminate abnormally. To check the setup identifiers (`_JFn`) of the embedded databases configured in the target host, execute the `ajsembdbidlist` command.

The following describes how to check the status of an embedded database.

In Windows:

- Check whether the service of the JP1/AJS3 Database `_JFn` (n : 0 to 9 or A to Z) has started. Start the service if inactive.
- Execute the `ajsembdbstatus` command with the `-s ust -id _JFn` (n : 0-9 or A-Z) options specified to confirm that the embedded database is running (UNIT-STAT is ONLINE). If the embedded database is not running, execute the `ajsembdbstart` command with the `-id _JFn` option specified.

In UNIX:

Execute the `ajsembdbstatus` command with the `-s ust -id _JFn` (n : 0-9 or A-Z) options specified to confirm that the embedded database is running (UNIT-STAT is ONLINE). If the embedded database is not running, execute the `ajsembdbstart` command with the `-id _JFn` option specified.

- When you use this command to add, delete, or rename a scheduler service, see the following manual sections:

In Windows:

- In a non-cluster environment
 - 6.1.1 Settings for starting multiple scheduler services in the JP1/Automatic Job Management System 3 Configuration Guide*
- In a cluster environment
 - 8.2.10 Setting startup of multiple scheduler services on a logical host in the JP1/Automatic Job Management System 3 Configuration Guide*
- In an environment using an external database

24.4.1(1) On a Windows host in the JP1/Automatic Job Management System 3 Configuration Guide

In UNIX:

- In a non-cluster environment
15.1.1 Settings for starting multiple scheduler services in the JP1/Automatic Job Management System 3 Configuration Guide
- In a cluster environment
17.2.10 Setting startup of multiple scheduler services on a logical host in the JP1/Automatic Job Management System 3 Configuration Guide
- In an environment using an external database
24.4.1(2) On a Linux host in the JP1/Automatic Job Management System 3 Configuration Guide

The command might end normally even if the command was executed without performing the processing to stop the JP1/AJS3 services as described in the above procedure. In such a case, after the command finishes execution, perform any necessary processing (stop the JP1/AJS3 services, delete the information about the shared memory, etc.).

- If Windows Firewall is used, a pop-up message might be displayed during setup processing of the embedded database. If a pop-up message is displayed, registration in the Windows Firewall exceptions list is required. Take action by referring to the notes on the `ajsembdbinstl` command.
- To execute this command, the JP1/AJS3 logical host must be reachable using the IP address resolved from the logical host name.
- For the port numbers for the embedded database and the job status communication port, you must specify port numbers that are not used within the system. Therefore, make sure that different values are specified for the `-P` option (port number for the embedded database) and the port number used by the service specified for the `-p` option (service name of the job status communication port).
- The command might terminate abnormally, outputting the following message: Database maintenance failed (func code=xx, error code=yy). If this message is output, take appropriate action according to the following table.

| Value of xx | Action |
|-------------|---|
| 1 | Correct the error indicated in the message output before this message according to the action to be taken if an error occurs in the <code>ajsembdbbuild</code> command. Then re-execute the command. |
| 2 | Correct the error indicated in the message output before this message according to the action to be taken if an error occurs in the <code>ajsembdbsetup</code> command. Then re-execute the command. |
| 3 | Correct the error indicated in the message output before this message according to the action to be taken if an error occurs in the <code>ajsembdbunset</code> command. Then re-execute the command. |
| 4 | Correct the problem according to the error message output before this message, and then re-execute the command. |
| 5 | Check 2.7.8(1) Action to be taken if an error occurs during embedded database maintenance in the manual JP1/Automatic Job Management System 3 Troubleshooting for error code yy in the output message, and correct the problem. |
| 6 | Check 2.7.8(2) Action to be taken if an error occurs during installation of the embedded database in the manual JP1/Automatic Job Management System 3 Troubleshooting for error code yy in the output message, and correct the problem. |
| 7 | Check 2.7.8(3) Action to be taken if an error occurs during uninstallation of the embedded database in the manual JP1/Automatic Job Management System 3 Troubleshooting for error code yy in the output message, and correct the problem. |

- On the standby host in a cluster configuration, you cannot use the `jajs_setup` command to add or remove a scheduler service.

If you want to perform these operations on the standby host, use the applicable JP1/Base commands. The procedures are as follows.

To add a scheduler service:

1. On the executing host, execute the following command to export the configuration definition of the logical host to a file:

```
jbsgetcnf -h logical-host-name > output-file-name
```

2. On the standby host, execute the following command to import the file you created in step 1:

```
jbssetcnf output-file-name
```

To remove a scheduler service:

1. On the standby host, execute the following command:

```
jbsunsetcnf -h logical-host-name -c "JP1AJSMANAGER\scheduler-service-name"
```

- To rename a scheduler service that has an operation profile, change the file name of the operation profile. For example, suppose that the AJSROOT2 scheduler service has a unit-attribute profile and you want to change the service name to AJSROOT3. To do so, change the file name of the unit-attribute profile as follows:
Old name: `ajsprof_AJSROOT2_unit.conf`
New name: `ajsprof_AJSROOT3_unit.conf`
- When deleting a scheduler service, delete its operation profile as needed.
- After executing the `jaajs_setup` command with the `-S` option specified, always perform advanced setup to complete setup of the embedded database. An attempt to start the JP1/AJS3 service or execute a command without completing setup of the embedded database will fail with the KAVS1516-E message.
- In Windows, if you add a scheduler service to an embedded database whose installation directory is set to a path different from the default path, execute the `jaajs_setup` command with the `-S` option specified. Then, perform advanced setup of the embedded database.
- The initial value of the environment setting parameter for the scheduler service to be added differs depending on whether the JP1/AJS3 version is 10-50 or earlier, or 11-00 or later. For details about the difference of the initial value, see *C.2 Environment setting parameters whose defaults were changed to recommended values in version 11-00 in the JP1/Automatic Job Management System 3 Configuration Guide*.
- If the database to be used is an external database, an instance of the target database must be running. If no instances of the target database are running, any command that is executed will terminate abnormally.
- If an external database is used as the database of a scheduler service or execution agent information, you cannot add a scheduler service whose database is embedded.
- If an embedded database is used as the database of a scheduler service or execution agent information, you cannot add a scheduler service or set up execution agent information by using an external database.
- If a scheduler service or execution agent information exists, you cannot set up execution agent information by using an external database.
- To add a scheduler service whose database is external, execution agent information must have already been set up by using an external database.
- In Linux, if the database adds a scheduler service of an external database or sets up execution agent information, and a non-existent ODBC file data source name is specified for the `-of` option of the `jaajs_setup` command, the ODBC driver might create a 0-byte file. If this occurs, check to make sure that the file is unnecessary, and then manually delete the file.
- To add a scheduler service whose database is embedded, make sure that the setting of the backup enhancement function (enabled or disabled) matches between the scheduler service and the embedded database. If you execute

the command by specifying a value that differs from the setting of the configured embedded database, the scheduler service cannot be added.

- To add a scheduler service with the backup enhancement function enabled to a configured embedded database, that embedded database must be set up with the backup enhancement function enabled. To check whether this function is enabled for the embedded database, output the configuration information for the embedded database by using the `ajsembdbstatus` command, and then check the value of the output item `ENHANCEDBACKUP`.

For details about the `ajsembdbstatus` command, see [ajsembdbstatus in 3. Commands Used for Normal Operations](#).

Return values

| | |
|---------------|--|
| 0 to 9 | Normal end |
| 10 to 49 | End with warning. The command terminated but requires manual operations. |
| 50 or greater | Abnormal end |

Example 1

The command in this example adds a scheduler service to logical host `lhost` under the following conditions:

- scheduler service name: `AJSROOT2`
- scheduler service ID number: `2`
- name of the service for the port reporting the job status: `jp1ajs2report2`
- database directory name: `/var/opt/jp1ajs2/database/schedule/AJSROOT2`
- temporary directory name: `/var/opt/jp1ajs2/tmp/schedule2`
- job information directory name: `/var/opt/jp1ajs2/jobinf2`
- backup information directory name: `/var/opt/jp1ajs2/backup/schedule2`

```
jajs_setup -a -h JP1_DEFAULT -F AJSROOT2 -n 2 -p jp1ajs2report2
-d "/var/opt/jp1ajs2/database/schedule/AJSROOT2"
-t "/var/opt/jp1ajs2/tmp/schedule2"
-j "/var/opt/jp1ajs2/jobinf2"
-b "/var/opt/jp1ajs2/backup/schedule2"
```

Example 2

The command in this example adds a scheduler service to logical host `lhost` under the following conditions:

- scheduler service name: `AJSROOT3`
- scheduler service ID number: `3`
- name of the service for the port reporting the job status: `jp1ajs2report3`
- database directory name: `H:\JP1LHOST\jp1ajs2\database\schedule\AJSROOT3`
- temporary directory name: `H:\JP1LHOST\jp1ajs2\tmp\schedule3`
- job information directory name: `H:\JP1LHOST\jp1ajs2\jobinf3`
- backup information directory name: `H:\JP1LHOST\jp1ajs2\backup\schedule3`
- logical host shared directory name: `H:\JP1LHOST`

- setup identifier: `_JFA`
- embedded database port number: 22250

```
jajs_setup -a -h lhost -F AJSROOT3 -n 3 -p jplajs2report3
-d "H:\JP1LHOST\jplajs2\database\schedule\AJSROOT3"
-t "H:\JP1LHOST\jplajs2\tmp\schedule3"
-j "H:\JP1LHOST\jplajs2\jobinf3"
-b "H:\JP1LHOST\jplajs2\backup\schedule3"
-D "H:\JP1LHOST"
-I _JFA
-P 22250
```

Example 3

The command in this example changes the scheduler service name from AJSROOT2 to JP1AJS3001.

```
jajs_setup -r -F AJSROOT2 -A JP1AJS3001
```

Example 4

The command in this example deletes scheduler service AJSROOT2.

```
jajs_setup -e -F AJSROOT2
```

Example 5

The command in this example sets up execution agent information by using an external database.

```
jajs_setup -a -k SQLSVR -G -of C:\odbc\ajsdatasource.dsn -od AJSDB
```

Example 6

The command in this example adds a scheduler service with the following conditions by using an external database.

- scheduler service name: AJSROOT2
- scheduler service ID number: 2
- name of the service for the port reporting the job status: jplajs2report2
- database directory name: `/var/opt/jplajs2/database/schedule/AJSROOT2`
- temporary directory name: `/var/opt/jplajs2/tmp/schedule2`
- job information directory name: `/var/opt/jplajs2/jobinf2`
- backup information directory name: `/var/opt/jplajs2/backup/schedule2`
- ODBC file data source name: `/odbc/ajsdatasource.dsn`
- database name: AJSROOT2DB

```
jajs_setup -a -k SQLSVR -F AJSROOT2 -n 2 -p jplajs2report2
-d "/var/opt/jplajs2/database/schedule/AJSROOT2"
-t "/var/opt/jplajs2/tmp/schedule2"
-j "/var/opt/jplajs2/jobinf2"
```



```
-b "/var/opt/jplajs2/backup/schedule2"  
-of "/odbc/ajsdatasource.dsn" -od AJSROOT2DB
```

jajs_setup_cluster

Format

For JP1/AJS3 - Manager:

```
jajs_setup_cluster
  [-h logical-host-name]
  -F scheduler-service-name
  {-d shared-directory-name
  [-n scheduler-service-ID-number]
  [-m {cold|warm|hot}]
  {-P embedded-database-port-number
  -I embedded-database-setup-ID
  [-M {s|m|l}]
  [-E {byte | sjis}]
  [-B] |
  -S} |
  [-S | -C embedded-database-settings-file-name] }
  [-R]
```

For JP1/AJS3 - Agent:

```
jajs_setup_cluster
  [-h logical-host-name]
  [-d shared-directory-name]
```

Format 1 (for setting up JP1/AJS3 - Manager on the primary node)

```
jajs_setup_cluster
  [-h logical-host-name]
  -F scheduler-service-name
  -d shared-directory-name
  [-n scheduler-service-ID-number]
  [-m {cold|warm|hot}]
  {-P embedded-database-port-number
  -I embedded-database-setup-ID |
  [-M {s|m|l}]
  [-E {byte | sjis}]
  [-B] |
  [-S]}
```

Format 2 (for setting up JP1/AJS3 - Manager on the secondary node)

```
jajs_setup_cluster
  [-h logical-host-name]
  -F scheduler-service-name
  [-S | -C embedded-database-settings-file-name]
```

Format 3 (for setting up JP1/AJS3 - Agent on the primary node)

```
jajs_setup_cluster
  [-h logical-host-name]
  -d shared-directory-name
```

Format 4 (for setting up JP1/AJS3 - Agent on the secondary node)

```
jajs_setup_cluster  
  [-h logical-host-name]
```

Format 5 (for setting up JP1/AJS3 - Manager on the primary and secondary nodes at the remote site)

```
jajs_setup_cluster  
  [-h logical-host-name]  
  -F scheduler-service-name  
  -R
```

Description

The `jajs_setup_cluster` command sets up a JP1/AJS3 operating environment appropriate for the logical host. The command must be executed on both the primary and secondary nodes during setup of a cluster system environment.

Before you execute the `jajs_setup_cluster` command, make sure that the JP1/Base physical and logical environments have been set up.

This command creates a logical host environment by copying the environment of the physical hosts. Scheduler services are created by copying the settings of the default scheduler service on the physical hosts. If no scheduler service has been defined as the default, the command creates the scheduler service on the logical host by copying the setup of the scheduler service that has the smallest identifier number (set in the `AJSSERVICEID` environment setting parameter) among all the existing scheduler services on the physical host.

With the `-R` option specified, a scheduler service is added to the JP1/AJS3 logical host when setup of JP1/AJS3 - Manager on the primary and secondary nodes at the remote site has finished.

Execution privileges

In Windows: Administrators privileges

In UNIX: Superuser privileges

Arguments

-h *logical-host-name*

Specify the name of the logical host to be set up (a logical host name set in JP1/Base).

You can specify a character string of 1 to 32 bytes.

The environment will be created under the logical host name specified in this option.

The value of this option overrides the value of the `JP1_HOSTNAME` environment variable. If you omit this option, the value of `JP1_HOSTNAME` is assumed as the logical host name.

The command terminates abnormally in the following cases:

- When you omit this option and the `JP1_HOSTNAME` environment variable has not been set
- When a physical host name `JP1_DEFAULT` is specified as the logical host name of the logical host you are setting up
- When you are setting up the primary node and the JP1/AJS3 logical host is not reachable using the IP address resolved from the logical host name

-F scheduler-service-name

When setting up the primary node for JP1/AJS3 - Manager:

Specify the name of the scheduler service you want to create.

If you specify the name of an existing scheduler service, the command terminates abnormally.

When setting up the secondary node for JP1/AJS3 - Manager:

Specify the scheduler service name that you specified on the primary node.

If you specify the scheduler service name other than the above, the command terminates abnormally.

When setting up the remote site to enable disaster recovery operation up for JP1/AJS3 - Manager:

Specify the scheduler service name that you specified on the primary node of the main site.

If you specify the scheduler service name other than the above, the command terminates abnormally.

You can specify a character string of 1 to 30 bytes.

For the characters you can specify in a scheduler service name, see the note about scheduler services under *Table 20-2 Environment setting parameters (scheduler service environment setup)* in *20.4 Setting up the scheduler service environment* in the *JP1/Automatic Job Management System 3 Configuration Guide*.

You cannot omit this option when you perform setup for JP1/AJS3 - Manager.

-d shared-directory-name

Specify the full path name of the mount-point directory for the shared disk used to contain information that the secondary node can inherit from the primary node. You must specify an existing directory. If you specify a non-existent directory, the command terminates abnormally. Do not specify a disk on a network drive.

You can specify a character string of 1 to 122 bytes.

The command terminates abnormally if you specify the root directory (/) in UNIX or characters other than the drive letter (for example, C:) in the first two bytes of the character string in Windows.

You must specify this option when setting up the primary node. If you omit this option, the node is set up as the secondary node.

In the specified directory, the command creates the JP1AJS2 (in Windows) or jp1ajs2 (in UNIX) subdirectory, in which the environment definition files and execution environment for the logical host are created. However, if the subdirectory already exists, the command terminates abnormally. Before you use the `jajs_setup_cluster` command to set up the primary node, always mount the shared disk, and confirm that the subdirectory does not exist.

You cannot specify this option with the `-C` and `-R` options.

-n scheduler-service-ID-number

Use a decimal number to specify the number that identifies the scheduler service.

You can specify a value from 1 to 20.

You can specify this option only when setting up (with the `-d` option specified) the primary node in JP1/AJS3 - Manager.

Make sure that the ID number you specify is not used by the physical host or any logical host of the local host. If you specify an ID number that has already been used, the command terminates abnormally.

If you omit this option, the smallest available ID number is assumed. If the total number of scheduler services has already reached the maximum, assignment of the scheduler service ID number fails and the command terminates abnormally.

-m {cold|warm|hot}

Specify the scheduler service startup mode.

- `cold`
The scheduler service is started in cold-start mode.
- `warm`
The scheduler service is started in warm-start mode.
- `hot`
The scheduler service is started in hot-start mode.

You can specify this option only when setting up (with the `-d` option specified) the primary node in JP1/AJS3 - Manager.

If this option is omitted, the command assumes the value of the `STARTMODE` environment setting parameter for the scheduler service specified in the `DEFAULTSERVICENAME` environment setting parameter on the physical host.

-P *embedded-database-port-number*

Specify the port number of the embedded database used on the logical host if you also want to set up the embedded database during setup of the logical host.

You can specify a value from 5001 to 65535.

You cannot specify a port number that has already been used by another program. Make sure that the port number you specify is not used by another program. If the port number specified in this option is also used by another application, a problem with either the application or the embedded database occurs. If a problem occurs, change the port number of either the application or the embedded database.

You cannot omit this option if you want to set up the embedded database at the same time that setup (with the `-d` option specified) of the primary node in JP1/AJS3 - Manager is performed.

You cannot specify this option with the `-C`, `-R`, and `-S` options.

-I *embedded-database-setup-ID*

Specify `_JFn` (n : 1 to 9 or A to Z) as a four-character setup ID of the embedded database to be used on the logical host if you also set up the embedded database during setup of the logical host. Make sure that the setup ID you specify has not yet been registered in the system. If you specify a setup ID that has already been registered, the command terminates abnormally. You can use the `ajsembdbidlist` command to check the setup IDs that have already been registered. For details on the `ajsembdbidlist` command, see [ajsembdbidlist in 2. Commands Used during Setup](#).

You cannot omit this option if you also set up the embedded database during setup of the primary node for JP1/AJS3 - Manager.

You cannot specify this option with the `-C`, `-R`, and `-S` options.

-M {s|m|l}

Specify the database model of the embedded database to be configured.

For details about the database model and disk requirements, see [23.2 Estimating the database area](#) in the *JP1/Automatic Job Management System 3 Configuration Guide*.

If you configure the embedded database with `l` specified in this option, the auto-increment function of the embedded database is disabled. If you want to use this function, perform an advanced setup.

You cannot specify this option with the `-C`, `-R`, and `-S` options.

-E {byte|sjis}

Specifies for the database of the specified scheduler service whether the same number of characters can be specified for items such as a unit name in both Shift-JIS and UTF-8 environments. If you omit this option, the system assumes `byte`.

This option can be specified in UNIX, and cannot be specified in Windows.

You cannot specify this option with the `-C`, `-R`, or `-S` option.

- `byte`

The database is set up so that the number of characters specifiable in a UTF-8 environment becomes the number of characters specified after conversion in UTF-8. If this option is specified, the number of characters specifiable for items such as a unit name in a Shift-JIS environment and a UTF-8 environment will not be the same.

If you execute the command with this option specified, `byte` is specified for the `DEFLENTYPE` environment setting parameter.

- `sjis`

The database is set up so that the number of characters specifiable in a UTF-8 environment is converted to the number of characters specifiable in a Shift-JIS environment. If this option is specified, the number of characters that can be used in the definition items for a unit in the UTF-8 environment is the same as that in the Shift-JIS environment.

This setting applies to the following items:

- **Unit name** in the detailed unit definition
- **Comment** in the detailed unit definition
- **Exclusive jobnet** in the schedule settings

If you execute the command with this option specified, `sjis` is specified for the `DEFLENTYPE` environment setting parameter and `UTF-8` is specified for the `AJSCHARCODE` environment setting parameter.

-B

Specify this option to enable the backup enhancement function when an embedded database is used. If you omit this option, the backup enhancement function is not enabled.

You cannot specify this option with the `-C`, `-R`, and `-S` options.

-C *embedded-database-settings-file-name*

Specify the embedded database settings file.

The number of characters you can specify is from 1 to 255 (bytes).

When creating a cluster environment on a secondary node, copy the following embedded database settings file located on the primary node to the secondary node.

In Windows:

```
embedded-database-practical-directory\conf\ajsdbst\ajsembdb-setup-identifier.conf
```

In UNIX:

```
embedded-database-practical-director/conf/ajsdbst/ajsembdb-setup-identifier.conf
```

If you specify the `-M` option when creating the primary node you must specify this option. If you specify this option when creating an environment on the primary node, the KAVS0116-E message is output, and the command ends abnormally.

If the contents of the embedded database settings file are invalid, the KAVS2130-E message is output, and the command ends abnormally.

You cannot specify this option for embedded databases configured in JP1/AJS3 version 09-50 or earlier.

This option cannot be specified together with options other than the `-h` and `-F` options.

Before performing an advanced setup for the embedded database on the executing host, create the following directories on the standby host just as they are specified on the executing host:

- Unload log file creation directory
- Embedded database work area directory
- Embedded database installation directory

Note that during setup of the executing host, if you specify a directory on the local disk as the unload log file creation directory, you must also create an unload log file creation directory on the standby host.

-S

Specify this option to set up an embedded database separately by performing an advanced setup instead of setting up the embedded database by using the regular method. After you execute the `jajs_setup_cluster` command with this option specified, complete configuration of the embedded database.

If you execute the `jajs_config`, `jajs_setup`, or `jajs_setup_cluster` command before completing configuration, the command outputs the KAVS1516-E error message and terminates abnormally.

For details about setting up the embedded database by performing an advanced setup, see *23.5 Advanced setup for the embedded database (in a cluster configuration)* in the *JP1/Automatic Job Management System 3 Configuration Guide*.

You can specify this option only when you perform setup for JP1/AJS3 - Manager.

You cannot specify this option with the `-C`, `-M`, `-R`, `-P` and `-I` options.

-R

Specify this option to set up a logical host at the remote site in a disaster recovery environment.

You cannot specify this option with any other options except `-h` and `-F`.

Notes

- Before you execute this command, stop all JP1/AJS3 services.
- Do not execute this command more than once in quick succession.
- Do not terminate this command forcibly.
- This command copies the `jp1ajs_spmd.conf` file from the physical host to a logical host. For this reason, if you edit the `jp1ajs_spmd.conf` file on the physical host to set the startup of a process or to set the suppression of the startup process, the settings are passed to the logical host. In such cases, a process unnecessary for the logical host might start, or a process required for the logical host might not start. If the file was edited on the physical host, edit the file on the logical host so that only necessary processes are started.

For details about suppressing the startup process, see *13.1.6 Limiting JP1/AJS3 - Manager resources to those used for job operation* in the *JP1/Automatic Job Management System 3 Administration Guide*.

- If Windows Firewall is used, a pop-up message might be displayed during setup processing. If a pop-up message is displayed, registration in the Windows Firewall exceptions list is required. Take action by referring to the notes on the `ajsembdbinstl` command.
- The command might terminate abnormally, outputting the following message: Database maintenance failed (func code=xx, error code=yy) . If this message is output, take appropriate action according to the following table.

| Value of xx | Action |
|-------------|---|
| 1 | Correct the error indicated in the message output before this message according to the action to be taken if an error occurs in the <code>ajsembdbbuild</code> command. Then re-execute the command. |
| 2 | Correct the error indicated in the message output before this message according to the action to be taken if an error occurs in the <code>ajsembdbsetup</code> command. Then re-execute the command. |
| 3 | Correct the error indicated in the message output before this message according to the action to be taken if an error occurs in the <code>ajsembdbunset</code> command. Then re-execute the command. |
| 4 | Correct the problem according to the error message output before this message, and then re-execute the command. |
| 5 | Check 2.7.8(1) <i>Action to be taken if an error occurs during embedded database maintenance</i> in the manual <i>JP1/Automatic Job Management System 3 Troubleshooting</i> for error code yy in the output message, and correct the problem. |
| 6 | Check 2.7.8(2) <i>Action to be taken if an error occurs during installation of the embedded database</i> in the manual <i>JP1/Automatic Job Management System 3 Troubleshooting</i> for error code yy in the output message, and correct the problem. |
| 7 | Check 2.7.8(3) <i>Action to be taken if an error occurs during uninstallation of the embedded database</i> in the manual <i>JP1/Automatic Job Management System 3 Troubleshooting</i> for error code yy in the output message, and correct the problem. |

- If an error occurs during command execution on the primary node, correct the cause of the error, and then delete the logical host information as described in *Action to be taken if an error occurs on the primary node* below. Then re-execute the command.
- If an error occurs during command execution on the secondary node, correct the cause of the error, and then re-execute the command (without deleting logical host information).
- Do not delete the scheduler service specified in the `-F` option when you set up JP1/AJS3 - Manager on the primary node. If you delete that scheduler service, setup on the secondary node will fail. If you need to delete the scheduler service, delete the information on the primary node as described in *Action to be taken if an error occurs on the primary node* below. Then perform the setup again, starting from the primary node.
- If the scheduler service on the physical host has an operation profile, the operation profile will be copied to the logical host when you execute this command. Delete the copied operation profile as needed.
- This command copies the executable-command settings file from the physical host to the logical host. After the file is copied, the logical host inherits the settings for commands that can be executed from the physical host. If commands can be executed on the physical host from JP1/AJS3 - View, edit the executable-command settings file on the logical host to allow the execution of necessary commands only. For details about how to specify settings in the executable-command settings file, see 11.3.18 *Allowing execution of JP1/AJS3 commands* in the *JP1/Automatic Job Management System 3 Operator's Guide*.
- To change the directory used by the scheduler service, perform the following.
 - To change the database directory, change the value of the `AJSDBDIRECTORY` environment setting parameter.
 - To change the temporary directory, change the value of the `AJSTMPDIR` environment setting parameter.
 - To change the job information directory, change the value of the `JOBINFDIR` environment setting parameter.

- To change the backup information directory, change the value of the AJSBKUROOT environment setting parameter.

For details about these parameters, see *20.4.2 Details of the environment setting parameters for scheduler services* in the *JP1/Automatic Job Management System 3 Configuration Guide*.

Action to be taken if an error occurs on the primary node

If an error occurs during execution of the `jaajs_setup_cluster` command on the primary node, remove the cause of the error, and then delete logical host information. Then re-execute the command.

If setup of the logical host fails and the `jaajs_setup_cluster` command outputs error message KAVS1126-E, you must delete the embedded database on the logical host. You do not need to do so, however, if you specified the `-S` option to skip setup of the embedded database, and logical host setup fails without error message KAVS1126-E appearing.

If an error occurs or a command is terminated forcibly during setup of the embedded database, the embedded database must be deleted from the logical host. Use the `ajsembdbuninstl` command to delete the embedded database on the logical host. For details on the `ajsembdbuninstl` command, see *ajsembdbuninstl* in *2. Commands Used during Setup*. Note that you must delete the embedded database from the logical host before deleting the logical host.

The procedure for deleting logical host information is described below.

To delete logical host information:

1. Delete the shared files and directories on the shared disk.

Delete the JP1/AJS3 shared disk information.

In Windows: `shared-disk\JP1AJS2`

In UNIX: `shared-disk/jp1ajs2`

2. Delete the JP1/AJS3 common definition information on the logical host.

To do this, execute the commands shown below. For details on the `jbsunsetcnf` command, see the *JP1/Base User's Guide*.

```
jbsunsetcnf -i -h logical-host-name -c JP1AJS2
jbsunsetcnf -i -h logical-host-name -c JP1AJS2COMMON
jbsunsetcnf -i -h logical-host-name -c JP1NBQAGENT
jbsunsetcnf -i -h logical-host-name -c JP1NBQMANAGER#
jbsunsetcnf -i -h logical-host-name -c JP1NBQCLIENT
jbsunsetcnf -i -h logical-host-name -c JP1NBQNOTIFY
jbsunsetcnf -i -h logical-host-name -c JP1AOMMANAGER#
jbsunsetcnf -i -h logical-host-name -c JP1AOMAGENT
jbsunsetcnf -i -h logical-host-name -c JP1AJSMANAGER#
jbsunsetcnf -i -h logical-host-name -c JP1QLAGENT
#
```

Execute this command only when you delete logical host information from JP1/AJS3 - Manager.

If the data to be deleted does not exist during execution of the command, the following message might be output: `KAVA0405-I The specified character-string-specified-for-the-c-option does not exist (logical-host-name) . Processing stops..` If this message is output, ignore it.

Permissions for sub-directories in the shared directory created at setup of the primary node

For Windows

Full Control is set for the **Everyone** group for all folders created in the *shared-folder\jplajs2* path and listed in the table below. For all other folders, the permissions of the upper-level folder apply.

For folders above *shared-folder\jplajs2*, set **Full Control** for users who have SYSTEM and Administrators privileges, and set **Read & Execute** or a higher privilege for all other users who perform settings to pass these settings to the files and folders under the folder.

Important

Do not change the permission for folders for which **Everyone** has **Full Control**. If you do so, the logical host will not start.

Table 2–3: Folders for which Everyone has Full Control

| No. | Folder path | JP1/AJS3 - Manager | JP1/AJS3 - Agent |
|-----|---------------------------------------|--------------------|------------------|
| 1 | <i>shared-folder\jplajs2\backup</i> | Y | -- |
| 2 | <i>shared-folder\jplajs2\database</i> | Y | -- |
| 3 | <i>shared-folder\jplajs2\jobinf</i> | Y | -- |
| 4 | <i>shared-folder\jplajs2\log</i> | Y | Y |
| 5 | <i>shared-folder\jplajs2\sys</i> | Y | Y |
| 6 | <i>shared-folder\jplajs2\tmp</i> | Y | Y |

Legend:

Y: Supported

--: Not supported

For UNIX

Directories are created in the *shared-directory/jplajs2* path and 777 permission is set for all directories listed in the table below. For all sub-directories not listed in the table, 755 permission is set.

When the AJS administrator sets up a primary node, read and write permissions of the JP1 administrator group are required for the upper-level directory of *shared-directory/jplajs2*.

Important

Do not change the permission for directories for which 777 permission is set. If you do so, the logical host will not start.

Table 2–4: Directories for which 777 permission is set

| No. | Directory path | JP1/AJS3 - Manager | JP1/AJS3 - Agent |
|-----|--|--------------------|------------------|
| 1 | <i>shared-directory/jplajs2/backup/schedule</i> | Y | -- |
| 2 | <i>shared-directory/jplajs2/database/schedule/scheduler-service-name</i> | Y | -- |
| 3 | <i>shared-directory/jplajs2/jobinf</i> | Y | -- |

| No. | Directory path | JP1/AJS3 - Manager | JP1/AJS3 - Agent |
|-----|--|--------------------|------------------|
| 4 | <i>shared-directory/jp1ajs2/jobinf/schedule/scheduler-service-name</i> | Y | -- |
| 5 | <i>shared-directory/jp1ajs2/jobinf/delete</i> | Y | -- |
| 6 | <i>shared-directory/jp1ajs2/log</i> | Y | Y |
| 7 | <i>shared-directory/jp1ajs2/log/JAJS_SETUP</i> | Y | Y |
| 8 | <i>shared-directory/jp1ajs2/log/jpqagent</i> | Y | Y |
| 9 | <i>shared-directory/jp1ajs2/log/jpqclient</i> | Y | Y |
| 10 | <i>shared-directory/jp1ajs2/log/jpqmanager</i> | Y | -- |
| 11 | <i>shared-directory/jp1ajs2/log/jpqnotify</i> | Y | Y |
| 12 | <i>shared-directory/jp1ajs2/log/schedule</i> | Y | -- |
| 13 | <i>shared-directory/jp1ajs2/log/schedule/scheduler-service-name</i> | Y | -- |
| 14 | <i>shared-directory/jp1ajs2/tmp</i> | Y | Y |
| 15 | <i>shared-directory/jp1ajs2/tmp/schedule</i> | Y | -- |
| 16 | <i>shared-directory/jp1ajs2/tmp/schedule/scheduler-service-name</i> | Y | -- |

Legend:

Y: Supported

--: Not supported

Return values

| | |
|---------------|--|
| 0 to 9 | Normal end |
| 10 to 49 | End with warning. The command terminated but requires manual operations. |
| 50 or greater | Abnormal end |

Additional information

When setup is performed by specifying the `-P` and `-I` options, the embedded database is set up with the following settings:

- Database mode: small scale
- System log: Not used
- Duplex of system file: Disabled
- Unload log file: Not used
- Data area directory:

For Windows

shared-folder\jp1ajs2\embdb\value-specified-in-the-I-option\dbarea

For UNIX

shared-directory/jp1ajs2/embdb/value-specified-in-the-I-option/dbarea

- Work area directory:

For Windows

JP1/AJS3-installation-folder\emddb\value-specified-in-the-I-option\dbarea

For UNIX

/opt/jp1ajs2/emddb/value-specified-in-the-I-option/dbarea

- Embedded database practical directory:

For Windows

JP1/AJS3-installation-folder\emddb\value-specified-in-the-I-option

For UNIX

/opt/jp1ajs2/emddb/value-specified-in-the-I-option

- Database area auto-increment function: Enabled
- System log auto-increment function: Enabled

For the settings other than the above, the default settings are used.

Example 1

In this example, the command also sets up the embedded database under the following conditions during setup of the primary host for JP1/AJS3 - Manager:

- logical host: `lhost1`
- scheduler service: `AJS3SCHEDULE001`
- shared directory name: `F:\shdisk\lhost1`
- embedded database port number: `22201`
- embedded database setup ID: `_JF1`

```
jajs_setup_cluster -h lhost1 -F AJS3SCHEDULE001 -d "F:\shdisk\lhost1" -P 22201 -I _JF1
```

Example 2

In this example, the command sets up the primary host for JP1/AJS3 - Manager under the following conditions, but does not set up the embedded database:

- logical host: `lhost2`
- scheduler service: `AJS3SCHEDULE002`
- shared directory name: `F:\shdisk\lhost2`
- scheduler service ID number: `3`
- scheduler service startup mode: `hot start`

```
jajs_setup_cluster -h lhost2 -F AJS3SCHEDULE002 -d "F:\shdisk\lhost2" -n 3 -m hot -S
```

Example 3

In this example, the command also sets up the embedded database under the following conditions during setup of the secondary host for JP1/AJS3 - Manager:

- logical host: lhost1
- scheduler service: AJS3SCHEDULE001

```
jajs_setup_cluster -h lhost1 -F AJS3SCHEDULE001
```

Example 4

In this example, the command sets up the secondary host for JP1/AJS3 - Manager under the following conditions, but does not set up the embedded database:

- logical host: lhost2
- scheduler service: AJS3SCHEDULE002

```
jajs_setup_cluster -h lhost2 -F AJS3SCHEDULE002 -S
```

Example 5

In this example, the command sets up the primary host for JP1/AJS3 - Agent under the following conditions:

- logical host: lhosta1
- shared directory name: F:\shdisk\lhosta1

```
jajs_setup_cluster -h lhosta1 -d "F:\shdisk\lhosta1"
```

Example 6

In this example, the command sets up the secondary host for JP1/AJS3 - Agent under the following conditions:

- logical host: lhosta1

```
jajs_setup_cluster -h lhosta1
```

jpomailrecv (UNIX only)

Format

```
jpomailrecv
  -u monitor-user-name
  [-t retry-timeout-period]
```

Description

Sets the email distribution feature that acquires mail using the alias of the SMTP mail server, creates an email file specific to mail reception monitoring, and then controls exclusive lock.

Execution privileges

None

Arguments

-u *monitor-user-name*

Specify the user name specified for the `UserName` environment setting parameter.

You can specify 1 to 256 characters (bytes).

-t *retry-timeout-period*

Specify the retry timeout period for editing when the email file that you have attempted to edit is locked.

You can specify 1 to 1,440 (minutes). If you omit this option, the system assumes an unlimited number of retries.

Notes

- To execute the `jpomailrecv` command, you must first start the JP1/AJS3 service.
- For the `UserName` environment setting parameter, specify the same user name as the monitoring user name of the command. In addition, before executing the command, use the `jaajs_config` command to apply the contents of the `UserName` environment setting parameter to the system. For details about the `UserName` environment setting parameter and the setting procedure with the `jaajs_config` command, see *2.4.2 Setting up the environment for an email reception monitoring job* in the *JP1/Automatic Job Management System 3 Linkage Guide*.
- If an error occurs during command execution or if edit retry is timed out, the received email is returned to the sender (except for the case where the locked file cannot be deleted).
- Code this command in the alias file and start it from the SMTP mail server. The system does not guarantee the operation of this command if it is started manually.
- When coding this command in the alias file, enclose it in double quotation marks ("").

Example 1

When `mailuser` is specified for the `UserName` environment setting parameter, the retry timeout period is set to 10 minutes.

```
mailuser:"|/opt/jplajs2/bin/jpomailrecv -u mailuser -t 10"
```

Example 2

When `user1` is specified for the `UserName` environment setting parameter, the retry period never times out.

```
user1:user1,"|/opt/jplajs2/bin/jpomailrecv -u user1"
```

jpqregguestuser

Format

```
jpqregguestuser  
    [-lh logical-host-name] [{-lu user-name|-d}]
```

Description

When using the assumed JP1 user function, you can use this command to register only one JP1 assumed user in the specified manager host. You can also use this command to display information for the registered assumed-JP1 user.

To reflect the contents set by this command, you must restart JP1/AJS3 after executing this command.

Execution privileges

In Windows: Administrators privileges

In UNIX: Superuser privileges

Arguments

-lh *logical-host-name*

Specify the name of the logical host for the manager host on which the assumed-JP1-user information is to be registered.

You can specify 1 to 255 characters (bytes).

If you omit this option, the system assumes the local host name.

-lu *user-name*

Specify the name of the assumed JP1 user using lowercase letters.

You can specify 1 to 31 characters (bytes).

If you omit this option, the system does not register the information for the assumed JP1 user. At this time, if a JP1 user has already been assumed, the following message is output to the standard output: KAVU0819-I Assumed JP1 user (*assumed-JP1-user-name*) is registered.

If the name of the JP1 user to be newly assumed is the same as that of the JP1 user that is already assumed, the information for the JP1 user being newly assumed overwrites that of the JP1 user that is already assumed.

-d

Deletes the information for the registered assumed JP1 user.

Specifying this option makes it impossible to use the assumed JP1 user function.

Notes

1. Do not execute this command if a JP1 series product that requires JP1/Base is running.
2. Specify a JP1 user name in lowercase letters. Note that uppercase letters are registered as lowercase letters. Registering JP1 user names in lowercase letters causes the information for that JP1 user to be newly assumed, after which the information for the currently assumed JP1 user is overwritten if his or her name is the same as that of the newly assumed JP1 user.

3. To use the assumed JP1 user function, register the assumed JP1 user specified by this command in the user mapping. You must also register this user in the agent host that executes jobs. Set a user privilege level for the operation that you want to perform.
4. For details about the purpose, usage procedure, and other notes for the command, see *7.1.6 Setting the assumed JP1 user function* in the *JP1/Automatic Job Management System 3 System Design (Configuration) Guide*.

Return values

| | |
|-----|--|
| 0 | Normal end |
| 1 | The specified argument is invalid. |
| 140 | You do not have the privilege (are not authorized) to execute this command. |
| 145 | There is insufficient memory. |
| 147 | An internal factor error occurred. |
| 160 | You attempted to delete assumed JP1 user information that is not registered. |
| 172 | The status in which the assumed JP1 user is registered is invalid. |

Additional information

Only the commands provided by JP1/AJS3 job execution control can assume JP1 users as a result of executing this command.

Registering a user as the assumed JP1 user allows even those OS users who are not registered as JP1 users to operate JP1/AJS3 using the assumed JP1 user privilege. If the OS user is registered as a JP1 user, use the JP1 user.

jpqreguser

Format 1

```
jpqreguser
  [-lh logical-host-name]
  [-lu user-name]
  -rh name-of-JP1/OJE-for-VOS3-host-connected
  -ru user-name-on-JP1/OJE-for-VOS3-host-connected
  [-rg group-name-on-JP1/OJE-for-VOS3-host]
```

Description 1

Before starting linkage with JP1/OJE for VOS3, this command registers VOS3 user information in the JP1/AJS3 host from which the job was submitted. It also changes the registered user information.

The users and hosts to be registered vary depending on whether you use JP1/AJS3 - View to execute the QUEUE job or use a command to execute a submit job. For details, see *6.2 Setup for executing QUEUE jobs or submit jobs* in the *JP1/Automatic Job Management System 3 Linkage Guide*.

Format 2

```
jpqreguser
  [-lh logical-host-name]
  [-lu user-name]
  -d
  -rh name-of-JP1/OJE-for-VOS3-host-connected
```

Description 2

Deletes the registered user information.

Format 3

```
jpqreguser
  [-lh logical-host-name]
  -a
```

Description 3

Lists registered user information.

Execution privileges

- For executing the command in Format 1 or Format 2 in Windows: Administrators privileges
- For executing the command with the `-lu` option specified:
 - In Windows: Administrators privileges
 - In UNIX: Superuser privileges
- In other cases: None

Arguments

-lh *logical-host-name*

Specify the logical host name of the JP1/AJS3 host in which user information is to be registered.

You can specify 1 to 255 characters (bytes). If you omit this option, the system assumes the local host name.

-lu *user-name*

Specify the user name that you use to operate JP1/OJE for VOS3 host jobs.

You can specify 1 to 63 characters (bytes).

Specify a JP1 user or OS user. Which type of user you specify depends on the user who requested the job. The type of the user requesting the job varies according to the following cases:

- When defining and executing a QUEUE job in a jobnet: JP1 user
- When executing a submit job: OS user

If you omit this option, the system assumes the login user name.

Only those users having Administrators privileges (in Windows) or superuser privileges (in UNIX) can specify this option.

-rh *name-of-JP1/OJE-for-VOS3-host-connected*

Specify the name of the JP1/OJE for VOS3 host to be connected.

You can specify 1 to 255 characters (bytes).

-ru *user-name-on-JP1/OJE-for-VOS3-host-connected*

Specify the user name on the JP1/OJE for VOS3 host used to operate a job for the host specified by the `-rh` option.

You can specify 1 to 32 characters (bytes).

-rg *group-name-on-JP1/OJE-for-VOS3-host*

Specify the name of the group on JP1/OJE for VOS3 to which the user specified by the `-ru` option belongs.

You can specify 1 to 32 characters (bytes). If you omit this option, the system assumes that there is no group.

-d

Deletes the registered user information.

If you want to delete information about a user who was specified in the `-lu` option during registration, you must also specify that user in the `-lu` option during deletion.

If you want to delete information about the default user (assumed if the `-lu` option was omitted during registration), you must enter the same password that was specified during registration.

-a

Lists user information.

Notes

- Do not execute this command if a JP1 series product that requires JP1/Base is running.
- If you want to submit a job to the JP1/OJE for VOS3 host or delete a submitted job, first register the user information. However, you can reference job information for the JP1/OJE for VOS3 host even if you do not register the user information.
- Registering, modifying, and deleting user information requires the entry of a password.
 - To register user information, enter the password corresponding to the user on the JP1/OJE for VOS3 host to be connected.
 - To modify user information, enter the password corresponding to the VOS3 user specified at registration. To change the specified VOS3 user to a new VOS3 user, also enter the password corresponding to the new VOS3 user.
 - To delete user information, enter the password corresponding to the VOS3 user specified at registration.
 - No password is required to change or delete user information that was registered with the `-lu` option specified.
 - You can register only one user name that differs only in whether it uses uppercase or lowercase letters.

For details on restricted values when specifying passwords and other information, see the manual Job Management Partner 1/Open Job Entry Description, User's Guide and Reference, for VOS3 systems.

- Before you execute this command on a computer running Windows, make sure that you open the Command Prompt window as an administrator. If the UAC function is disabled, you do not need to open the Command Prompt window as an administrator.

Notes on operating a cluster system

To operate a cluster system, you must set user information on both the executing host and standby host. If you add, change, or delete user information on the executing host, you must also add, change, or delete user information on the standby host.

To add, change, or delete user information on the standby host:

1. Execute the following command on the executing host to save the definition information.

```
jbsgetcnf -h logical-host-name > definition-information-file-name
```

For details on the `jbsgetcnf` command, see the *JP1/Base User's Guide*.

2. Execute the following command on the standby host to save the definition information as a backup.

```
jbsgetcnf -h logical-host-name > backup-file-name
```

3. Execute the following command on the standby host to delete the registered user information.

```
jbsunsetcnf -h logical-host-name -c JP1NBQCLIENT -n Profile
```

For details on the `jbsunsetcnf` command, see the *JP1/Base User's Guide*.

4. Using the definition information file you saved in step 1, execute the following command on the standby host.

```
jbssetcnf definition-information-file-saved-in-step-1
```

For details on the `jbssetcnf` command, see the *JP1/Base User's Guide*.

5. Restart JP1/AJS3 on the standby host.

The contents of the definition information file are applied to the system.

Return values

| | |
|---|------------------------------------|
| 0 | Normal end |
| 1 | The specified argument is invalid. |

| | |
|-----|---|
| 160 | You attempted to delete unregistered user information. |
| 165 | On a target host that is running Windows, a user without administrator privileges attempted to execute the command in Format 1 or Format 2. |
| 166 | The system cannot update or delete user information because the entered password does not match the registered password. |
| 170 | There is insufficient memory. |
| 171 | You do not have the privilege (are not authorized) to execute this command. |
| 172 | An internal factor error occurred. |

3

Commands Used for Normal Operations

This chapter describes the commands used for normal operations.

Format

```
ajs
  [[-F service-name
    |-v monitor
     -n full-path-jobnet or job-name
     {-l execution-ID | -m{state|result}}]
  [-a login-information-file-name]
  [-h login-host-name]
```

Description

Starts JP1/AJS3 - View. You can also specify arguments to perform the following operation:

- Directly start the Jobnet Monitor window without having to display and operate the Login screen or JP1/AJS3 - View window.
- Directly start the JP1/AJS3 - View window without having to display and operate the Login screen.

Execution privileges

None

Arguments

-F *service-name*

Specify the name of the target scheduler service.

You can specify a character string of 1 to 30 bytes.

-v *monitor*

Specify starting of the Jobnet Monitor window.

You must specify this option with the *-n*, *-l*, or *-m* option.

-n *full-path-jobnet* or *job-name*

Specify the full path unit name of the jobnet or job in the *scheduler-service-name*: */jobnet-name* or *scheduler-service-name*: */job-name* format.

You can specify a character string of 1 to 30 bytes for the scheduler service name and a character string of 1 to 930 bytes for the jobnet or job name.

You can also specify the name of a remote jobnet on the destination host in the *scheduler-service-name*: */remote-jobnet-name* format (Example: AJSROOT1:/1042614948234/net07).

If you specify a nested jobnet, the Jobnet Monitor window will display the specified nested jobnet highlighted in the tree area.

If you specify a job, the Jobnet Monitor window will display the jobnet containing the specified job highlighted in the tree area.

You must specify this option with the `-v`, `-l`, or `-m` option.

-l *execution-ID*

Specify the execution ID (a character string of up to 10 bytes) for the top-level jobnet to be displayed in the Jobnet Monitor window.

You must specify this option with the `-v` and `-n` options.

You cannot specify this option with the `-m` option.

-m {*state|result*}

Specify whether you want to view the state or result when the Jobnet Monitor window displays the jobnet or job specified with the `-n` option.

If you specify `state`, the window displays the current execution state of the jobnet or job, in the same way as when you choose **View - Jobnet Monitor - Status** in the JP1/AJS3 - View window.

If you specify `result`, the window displays the current execution results of the jobnet or job, in the same way as when you choose **View - Jobnet Monitor - Result** in the JP1/AJS3 - View window.

You must specify this option with the `-v` and `-n` options.

You cannot specify this option with the `-l` option.

Note that if `today` is set for the `VIEWSTATUSRANGE` environment setting parameter, the status or result of the day's generation is displayed.

-a *login-information-file-name*

Specify the name of the login information file that defines information necessary for logging in to JP1/AJS3 - Manager (user name, password, and destination host name).

If you specify this option, the system uses the information written in the login information file to log in to JP1/AJS3 - Manager and displays the JP1/AJS3 - View window or Jobnet Monitor window.

If you omit this option, the Login screen appears and, after you log in, the JP1/AJS3 - View window or Jobnet Monitor window appears.

The login information in the file is the same as the information you specify in the Login screen. For details about login information, see *3. Logging in and Logging out of JP1/AJS3 - Manager* in the *JP1/Automatic Job Management System 3 Operator's Guide*.

You can specify a character string of 1 to 255 bytes. For *login-information-file-name*, you cannot specify the following file names:

- A file name that includes a space
- A file name that begins with a hyphen (-)

If you specify a file name containing a space character, the system assumes the characters preceding the space character to be the file name. If you specify a file name containing a hyphen, the system does not recognize the file name and displays the following error message:

```
KAVV192-E A required parameter is missing.[-a]
```

You must store the login information file in the following location:

```
JP1/AJS3 - View-installation-folder\conf\
```

If the `conf` directory does not contain the login information file, the following error message appears:

```
KAVV380-E The login information file (file-name) is not found. Detailed information: detailed-information-1, detailed-information-2
```

Write the login information file in the following format:

```
username=login-user-name
password=password
host=destination-host-name-or-IP-address
```

Using a dot representation (for example, `100.100.1.1`), specify the IP address. The specified IP address must be an IPv4 address. It must not be an IPv6 address.

Each line must end with a line feed character. If you define two or more lines that contain the same keyword, the line defined first takes effect. Any keywords other than `username`, `password`, or `host` are ignored. A line beginning with a hash mark (`#`) is handled as a comment. The following shows an example:

```
#This is login information file for job server
username=user1
password=user0000
host=apserve
```

-h login-host-name-or-IP-address

Use this argument to temporarily change the connection-target host at automatic login. Using a dot representation (for example, `100.100.1.1`), specify the IP address. The specified IP address must be an IPv4 address. It must not be an IPv6 address.

When the `-h` option is specified, the system forces you to log in to the specified host. You will log in to the specified host even if the connection-target host name is specified in the login information file indicated by the `-a` option, or in the automatic login settings in the Environment Settings dialog box. When you specify both the `-a` option and the `-h` option as arguments of the startup command, you do not need to specify the connection-destination host name in the login information file.

If you are not performing automatic login by using the login information file indicated by the `-a` option or the Environment Settings dialog box, specify the default host name shown in the **Host to connect** text box in the Login screen that appears at startup.

Notes

- You cannot encrypt or scramble the password described in the login information file. Therefore, be sure to specify user privileges given by the OS to restrict access to the login information file.

The following shows an example of restricting access to the file based on the user privilege:

- Log in as the machine administrator user (such as Administrators) and choose the **Security** tab in the Properties dialog box for the login information file.
- From the **Names** list, select the users you want to permit or deny access.
- In the **Access permission** list, permit or deny access.

If the above steps cause a security problem, do not specify the password keyword. If you do not specify password, the error message KAVV140-E The keyword (*keyword-name*) is not specified in the login information file (*file-name*) . appears, followed by the Login dialog box. Then, enter the password.

- If you specify the `-a` option, the system logs in using the information specified in the login information file, ignoring the automatic login function even if you specify **Yes** for **Login - Auto login** in the Preferences dialog box for JP1/AJS3 - View.
- When starting multiple JP1/AJS3 - View hosts continuously, start the next JP1/AJS3 - View host after the JP1/AJS3 - View window of JP1/AJS3 - View previously opened is displayed. If you start the next JP1/AJS3 - View before the previous window opens, the preference information may become invalid.
- Always separate the option and its value by at least one space character.
- When you specify the name of the login information file, do not enclose the file name with double quotation marks (""). If you do so, an error message (KAVV380-E The login information file (*file-name*) is not found. Detailed information: *detailed-information-1*, *detailed-information-2*) appears.

Example 1

The following example directly starts the Jobnet Monitor window without displaying and operating the Login screen or the JP1/AJS3 - View window. It uses `apserver_login.txt` as the login information file and the Jobnet Monitor window will display the current results for the jobnet named `AJSROOT1:/GYOUMU_GROUP1/PC_job`.

```
ajs -v monitor -n AJSROOT1:/GYOUMU_GROUP1/PC_job -m result -a
apserver_login.txt
```

Example 2

The following example directly starts the JP1/AJS3 - View window without displaying and operating the Login screen. It uses `apserver_login.txt` as the login information file.

```
ajs -a apserver_login.txt
```

ajs2collectcore (UNIX only)

Format

```
ajs2collectcore
  [-b]
  [-c]
  [-f output-path-name]
  [-l]
  [-s]
  [core-dump-directory-or-core-dump-file...]
```

Description

Searches for core dump files (names beginning with `core`, `core-`, or `core.`) placed under the following directories and collects analysis information from those core dump files, if any.

- `/opt/jplajs2/`
- `/var/opt/jplajs2/`
- `/opt/jplajs2v/`
- `/opt/jplbase/bin/`
- `/var/opt/jplbase/log/`
- `/tmp/jplajs2/ajs2gencore_create/`
- `/var/lib/systemd/coredump/`

The following table describes the information you can collect with the `ajs2collectcore` command.

Table 3–1: Information that can be collected with the `ajs2collectcore` command

| Information category | Description | Output file name ^{#1} |
|----------------------------|---|---|
| Core dump | Obtains a core dump file (core). | <code>core.Z</code> |
| Backtrace information | Outputs primary analysis information about the core dump. | <code>coreinfo.backtrace.Z^{#2}</code> |
| Shared memory information | Outputs the contents of the shared memory that is used by ISAM, scheduler services, and the connection source restriction function. | <code>coreinfo-ISAM.shmdump.tar.Z</code> <code>coreinfo-scheduler.shmdump.Z</code> <code>coreinfo-pmtcon_m.shmdump.physical.Z</code> <code>coreinfo-pmtcon_a.shmdump.physical.Z</code> <code>coreinfo-pmtcon_m.shmdump.logical.Z</code> <code>coreinfo-pmtcon_a.shmdump.logical.Z</code> |
| Shared library information | Obtains information about existing shared libraries, excluding the following: <ul style="list-style-type: none">• <code>/opt/jplajs2/lib/</code>• <code>/opt/jplajs2v/lib/</code>• <code>/opt/jplbase/lib/</code> | <code>coreinfo-analyze.tar.Z^{#2}</code> |

^{#1}

Use `ajs2collectcore` to compress the collected data. The following describes the compression method used by each OS:

In Linux:

JP1/AJS3 uses the `gzip` command to compress data. The file extension is `.gz`. If `gzip` is not installed, data will not be compressed, and the extension `.gz` will not be appended to the output file name. Note that the `compress` command will not be used.

In UNIX systems other than Linux:

JP1/AJS3 uses the `compress` command to compress data. The file extension is `.Z`. If `compress` is not installed, and the `gzip` command is installed, JP1/AJS3 uses the `gzip` command to compress data instead of the `compress` command. In this case, the extension of the output file name is `.gz`. If neither the `compress` command nor the `gzip` command is installed, no data is compressed. In this case, neither extension `.Z` nor `.gz` is added to the output file name.

#2

There will be as many outputs as there are core dumps.

The collected files are output, as shown in the following example, under the output-destination directory (the default is `/tmp/jp1ajs2/core_analyze/`).

Example:

In the following example, the command is executed when there are core dump files under `/opt/jp1ajs2/bin/` (the output destination is the default):

```
/tmp/jp1ajs2/core_analyze/opt/jp1ajs2/bin/
```

The file list for the information collected is output at the same time. The file list is output immediately under the output-destination directory. The file name is shown below:

```
Ajs2collectcore_filelist.log
```

Execution privileges

Superuser privileges

Storage directory

```
/opt/jp1ajs2/tools/
```

Arguments

-b

Collects only the backtrace information in the core dump file to be collected.

Specifying this option together with the `-c`, `-l`, or `-s` option enables you to collect non-backtrace information as well. If you specify the `-c`, `-l`, or `-s` option but omit this option, backtrace information is not collected.

-c

Collects only the core dump file.

Specifying this option together with the `-b`, `-l`, or `-s` option enables you to collect non-backtrace information as well. If you specify the `-b`, `-l`, or `-s` option but omit this option, backtrace information is not collected.

-f *output-path-name*

Specify where to store the core dump information to be collected. Use an absolute path that does not contain space characters. Specifying the name with a relative path causes the command to terminate abnormally due to an argument error. If the specified path name contains a space character, the string before the space character is handled as the output path name and the string after the space character is regarded as another argument.

If you specify this option, core dump information is stored under the output path. If the specified output path does not exist, a message asking you whether to create the directory is output. To create the directory, enter *y*. If you enter *n*, the command does not collect the information.

If you omit this option, the default is `/tmp/jp1ajs2/core_analyze`.

-l

Collects only shared library information that excludes the target library supplied by JP1/AJS3.

Specifying this option together with the `-b`, `-c`, or `-s` option enables you to collect non-shared-library information as well. If you specify the `-b`, `-c`, or `-s` option but omit this option, the shared library information is not collected.

-s

Collects only the shared memory information to be collected.

At this time, if `coreinfo-ISAM.shmdump_*`, `coreinfo-Scheduler.shmdump_*`, `coreinfo-pmtcon_{m | a}.shmdump.physical_*`, or `coreinfo-pmtcon_{m | a}.shmdump.logical*_*` exists immediately under the destination directory path, back up the file, adding the extension `.bk`.

Specifying this option together with the `-b`, `-c`, or `-l` option enables you to collect non-shared-memory information as well. If you specify the `-b`, `-c`, or `-l` option but omit this option, the shared memory information is not collected.

core-dump-directory-or-core-dump-file

Other than for a search path for core dumps to be searched for in a standard configuration (see the Description section), specify the core-dump directory path or file name you want to additionally search for by using an absolute path that does not contain space characters. Specifying the name with a relative path causes the command to terminate abnormally due to an argument error. If the specified path name contains a space character, the string before the space character is handled as an output path name and the string after the space character is regarded as another argument.

If the search path contains core dump files (names beginning with `core`, `core-`, or `core.`), the command obtains the backtrace information and shared library information.

If you do not specify the core-dump directory or core dump file, the target of search is core dumps under the following directory paths.

- `/opt/jp1ajs2/` directory path
- `/var/opt/jp1ajs2/` directory path
- `/opt/jp1ajs2v/` directory path
- `/opt/jp1base/bin/` directory path
- `/tmp/jp1ajs2/ajs2gencore_create/` directory path
- `/var/lib/systemd/coredump/` directory path

Notes

- When you execute this command, if a file having the same name exists in the output path, an overwrite message appears. Entering `y` in response enables the overwrite; entering `n` cancels the process of collecting information.
- When you execute this command, if the output path specified by the `-f` option does not exist, a message appears asking you to confirm creation of the directory. Entering `y` in response enables creation of the directory; entering `n` cancels the process of collecting information.
- If there are two or more core dump files, information about all the files is collected.
- If you use these arguments to specify a core-dump directory or core dump file, execute the command after confirming that the files being placed at the destination and beginning with `core`, `core-`, or `core.` are limited to core dump files.
- Specifying the `-f` option enables you to start two or more instances of this command simultaneously if you specify individual directories for output destination.
- When you collect ISAM shared memory information, you may fail to output it in a `coreinfo-ISAM.shmdump.tar` file because of the capacity shortage in the output destination directory. If this occurs, check to see if there are `coreinfo-ISAM.shmdump_*` files without the `.bk` extension. If you find such files, which serve as ISAM shared memory information, execute the `tar` command in a different disk area and then send the information as data.
- If the system updates the very file that is executed in the target process after core-dump files are discharged, note that you will fail to properly collect analysis information from these core-dump files.
- To collect backtrace information, the `ajs2collectcore` command uses the module name that is output from the `file` command. This means that you cannot collect backtrace information from core dumps for which the module name is not displayed by the `file` command.
- It is only possible to search under `/var/lib/systemd/coredump/` by using the `ajs2collectcore` command if the OS environment is Red Hat Enterprise Linux Server 8 or later.
- If you search under `/var/lib/systemd/coredump/`, the `ajs2collectcore` command will only collect core dump files that are output by execution files under `/opt/jp1ajs2/`. The `ajs2collectcore` command does not collect core dump files that are output by execution files that are not under `/opt/jp1ajs2/`.

Return values

| | |
|--------------|--|
| 0 | All data items have been collected successfully. |
| 4 | Some of the data items have been collected successfully. |
| Other values | The process has terminated abnormally. |

Output messages

| Return value | Output message | Meaning | Operation | Action |
|--------------|---|-------------------------------------|---|------------------|
| 0 | Collection of the backtrace data [<i>file-name</i>] was successful. OutputPath: <i>output-path-name</i> | Normal collection (backtrace) | Normal termination or continued processing to obtain next information | (Not applicable) |
| 0 | Collection of the core dump file [<i>file-name</i>] was successful. OutputPath: <i>output-path-name</i> | Normal collection (core-dump files) | Normal termination or continued processing to obtain next information | (Not applicable) |

| Return value | Output message | Meaning | Operation | Action |
|--------------|--|---|---|--|
| 0 | Collection of the shared library data [<i>file-name</i>] was successful. OutputPath: <i>output-path-name</i> | Normal collection (library information) | Normal termination or continued processing to obtain next information | (Not applicable) |
| 0 | Collection of the {ISAM Scheduler {JP1_DEFAULT <i>logical-host-name</i> } PMTCON_M {JP1_DEFAULT <i>logical-host-name</i> } PMTCON_A} shared memory dump was successful. Output Path: <i>output-path-name</i> | Normal collection (shared memory information) | Normal termination or continued processing to obtain next information | (Not applicable) |
| 4 or 8 | Error!!The input parameter [<i>argument</i>] is invalid. << ### Usage ### >> ajs2collectcore [-b] [-c] [-l] [-s] [-f <i>output_fullpath</i>] [<i>additional_search_fullpath</i> ...] | Parameter error | Abnormal termination or continued processing (if there is an error in the additionally specified path) | Check the required parameters and re-execute the command. |
| 16 | Error!! The specified directory [<i>destination-directory</i>] could not be created. | Failure to create a destination directory | Abnormal termination | The destination disk might have reached its full capacity. Check the capacity of the destination disk. After taking steps to remedy the problem, re-execute the command. |
| 4 or 8 | Error!! The specified file [<i>file-name</i>] does not have overwrite permissions. | Failure to overwrite an existing file | Continued processing (Continuing to collect something other than the target file) | Assign write privileges to the target file and re-execute the command. |
| 4 or 8 | Error!! The backtrace data for the core dump file could not be collected. Corefile: <i>corresponding-core-dump-file-name</i> | Failure to collect backtrace information | Continued processing (Continuing to collect something other than the target backtrace information) | The destination disk might have reached its full capacity. Check the capacity of the destination disk. After taking steps to remedy the problem, re-execute the command. |
| 4 or 8 | Error!! The core dump file could not be collected. Corefile: <i>corresponding-core-dump-file-name</i> | Failure to collect core-dump files | Continued processing (Continuing to collect something other than the target core-dump file) | |
| 4 or 8 | Error!! Shared library data for the core dump file could not be collected. Corefile: <i>corresponding-core-dump-file-name</i> | Failure to collect shared library information | Continued processing (Continuing to collect something other than the target shared library information) | |
| 4 or 8 | Error!! {ISAM Scheduler {JP1_DEFAULT <i>logical-host-name</i> } PMTCON_M {JP1_DEFAULT <i>logical-host-name</i> } PMTCON_A} shared memory data could not be collected. | Failure to collect shared memory information | Continued processing (Continuing to collect something other than the target shared memory information) | This message is output when there is no shared memory. If you are not using shared memory, ignore the message. If you are using shared memory, the following errors are possible: <ul style="list-style-type: none"> • Memory is running short. • The destination disk has reached its capacity. |

| Return value | Output message | Meaning | Operation | Action |
|-------------------------|---|---|--|--|
| 4 or 8 | Error!! {ISAM Scheduler {JP1_DEFAULT <i>logical-host-name</i> } PMTCON_M {JP1_DEFAULT <i>logical-host-name</i> } PMTCON_A} shared memory data could not be collected. | Failure to collect shared memory information | Continued processing (Continuing to collect something other than the target shared memory information) | Check the state of memory use and the capacity of the destination disk. After taking steps to remedy the problem, re-execute the command. |
| 4, 8, or 124 | An error occurred!! ErrorCause: [<i>error-factor</i>] ErrorInfo: [<i>error-information</i>] | Other error | Continued processing (Continuing to collect something other than the target information) | (Not applicable) |
| (Not applicable) | There are no core dump files in default directories. | No core dumps found in a standard search path | (Not applicable) | (Not applicable) |
| (Not applicable) | There are no core dump files in the specified path. | No core dumps found in an additionally specified path | (Not applicable) | (Not applicable) |

ajsagtadd

Format

```
ajsagtadd
  [-h logical-host-name]
  {-a execution-agent-name [-s execution-host-name]
  [-c time-time=maximum-number-of-concurrently-executable-jobs,...]
  [-t {@|i|h|b}] [-d description] |
  -g execution-agent-group-name [-l execution-agent-name[:priority],...]
  [-t {@|i|h|b}] [-d description] |
  -f execution-agent-definition-file-name [-i]}
```

Format1 (adding an execution agent)

```
ajsagtadd
  [-h logical-host-name]
  -a execution-agent-name
  [-s execution-host-name]
  [-c time-time=maximum-number-of-concurrently-executable-jobs,...]
  [-t {@|i|h|b}]
  [-d description]
```

Format2 (adding an execution agent group)

```
ajsagtadd
  [-h logical-host-name]
  -g execution-agent-group-name
  [-l execution-agent-name[:priority],...]
  [-t {@|i|h|b}]
  [-d description]
```

Format3 (adding execution agents and execution agent groups all at one time)

```
ajsagtadd
  [-h logical-host-name]
  -f execution-agent-definition-file-name
  [-i]
```

Description

The `ajsagtadd` command adds an execution agent or an execution agent group.

You can also use the command to add execution agents and execution agent groups all at one time by using a file that specifies the items you want to add.

Execution privileges

This command can be executed by a user at the following JP1 permission level:

- JP1_JPQ_Admin privilege

Arguments

-h *logical-host-name*

Specify the logical host name of the local host to which you want to add execution agents and execution agent groups.

You can specify a character string of 1 to 255 bytes.

If this option is omitted, the logical host name specified in the `JP1_HOSTNAME` environment variable is assumed. If the `JP1_HOSTNAME` environment variable is not specified, the physical host name is assumed.

For a physical host, make sure that you specify neither this option nor the `JP1_HOSTNAME` environment variable.

-a *execution-agent-name*

Specify the name of an execution agent you want to add.

You can specify a character string of 1 to 255 bytes.

-g *execution-agent-group-name*

Specify the name of an execution agent group you want to add.

You can specify a character string of 1 to 255 bytes.

-f *execution-agent-definition-file-name*

Specify the name of a file that specifies execution agents and execution agent groups that you want to add collectively.

You can specify a character string of 1 to 255 bytes.

For details about the format of this file, see [Specifying the execution agent definition file settings](#) below. The format of this file is the same as the format of the output result of the `ajsagtprint` command.

Note that, for the default execution agent (named `@SYSTEM`) specified in the execution agent definition file, you can change only the maximum number of concurrently executable jobs and the comment.

-s *execution-host-name*

Specify the name of the host on which the job will be executed.

You can specify a character string of 1 to 255 bytes.

If this option is omitted, the name of the execution agent is assumed.

You can specify this option only if the `-a` option is specified.

-c *time-time=maximum-number-of-concurrently-executable-jobs, . . .*

Specify a time period and the maximum number of concurrently executable jobs to be applied to the time period.

By specifying the maximum number of concurrently executable jobs, you can limit the number of jobs that can concurrently be executed on this execution agent. The specified limit is applied to UNIX, PC, flexible, HTTP connection, action, custom, and passing information setting jobs. If an attempt is made to execute a job when the number of concurrently executing jobs has already reached the maximum, the job is queued to wait until the number of concurrently executing jobs becomes smaller than the maximum.

The time period is specified by using the start and end times separated by a hyphen (-). Both times are specified in *hh:mm* format where *mm* is specified in units of 30 minutes.

For *hh*, you can specify 0 or a value in the range from 00 to 23 (hours).

For *mm*, you can specify 0, 00, or 30 (minutes).

For *maximum-number-of-concurrently-executable-jobs*, you can specify a value from 0 to 4,294,967,295.

If this option is omitted, 00:00-00:00=5, which applies 5 as the maximum number of concurrently executable jobs for all day, is assumed.

You can specify multiple combinations of time period and maximum number of concurrently executable jobs. To do this, use a comma (,) to separate each occurrence of *time-time=maximum-number-of-concurrently-executable-jobs* without inserting a space. You can specify a maximum of 48 time periods. If you specify overlapping time periods, the last specified value takes effect for the maximum number of concurrently executable jobs. For example, if you specify `-c 1:00-2:30=5, 2:00-4:00=10`, the time period from 2:00 to 2:30 overlaps. For this time period, 10 is applied as the maximum number of concurrently executable jobs.

For the time periods that are not specified, 0 is assumed as the maximum number of concurrently executable jobs. For example, if you specify only `-c 1:00-5:00=10`, the maximum number of concurrently executable jobs are set as follows: 0 for the period from 0:00 to 1:00, 10 for the period from 1:00 to 5:00, and 0 for the period from 5:00 to 1:00.

If the command is executed during a specified time period, the maximum number of concurrently executable jobs for the time period immediately takes effect.

You can specify this option only if the `-a` option is specified.

-1 *execution-agent-name*[:*priority*], . . .

Specify the name of an execution agent to be associated with the execution agent group. Following the execution agent name, you can also specify the priority of the execution agent in the execution agent group. If you specify the priority, place a colon (:) as a separator between the execution agent name and the priority.

Make sure that you specify an execution agent name that has already been registered.

You can use 1 to 255 bytes to specify an execution agent name.

As the priority value, you can specify 1 to 16 where 1 is lowest and 16 is highest. A job with a higher priority value is executed earlier. If the priority is omitted, 16 is assumed.

If you want to associate multiple execution agents to the execution agent group, specify multiple occurrences of *execution-agent-name*[:*priority*] by using a comma (,) to separate each occurrence, without inserting a space. The maximum number of execution agents that can be associated is 1,024 (or 2,048 if the value of the environment setting parameter `AGENTLIMITTEXTEND` is 2).

You can specify this option only if the `-g` option is specified.

-t {*e|i|h|b*}

Specify the job transfer restriction status of the execution agent or execution agent group to be added.

| Value | Status | Description |
|-------|-----------|--|
| e | Effective | Jobs are accepted and then delivered to the target host. |

| Value | Status | Description |
|-------|-------------|--|
| i | Ineffective | New jobs are not accepted but the jobs that have already been accepted are delivered to the target host. |
| h | Hold | Jobs are accepted but are not delivered to the target host. |
| b | Blockade | Jobs are neither accepted nor delivered to the target host. |

If you omit this option, the system assumes e.

You can specify this option only if the `-a` or `-g` option is specified.

-d description

Specify a comment on the execution agent or execution agent group to be added.

You can specify a character string of 1 to 80 bytes.

You can specify this option only if the `-a` or `-g` option is specified.

-i

This option pertains to collective addition of execution agents and execution agent groups by using the execution agent definition file. If you specify this option, addition processing does not stop when an error occurs during the processing.

If you omit this option, the addition processing stops when an error occurs. If the addition processing stops, only the execution agents and execution agent groups processed before the error occurred are added.

This option takes effect only if the contents of the execution agent definition file are correct. If the contents are not correct, the command terminates without adding anything.

You can specify this option only if the `-f` option is specified.

After you specify this option to add execution agents and execution agent groups collectively, always execute the `ajsagtshow` or `ajsagtprint` command to confirm the result of addition. For details on the `ajsagtshow` command and the `ajsagtprint` command, see [ajsagtshow](#) in *3. Commands Used for Normal Operations* and [ajsagtprint](#) in *3. Commands Used for Normal Operations*.

Notes

- The maximum number of concurrently executable jobs, the job transfer restriction status, and the execution agent priority specified by this command are not applied to event jobs and custom event jobs.
- This command cannot be used for a request from JP1/AJS3 to JP1/OJE for VOS3.
- This command cannot be executed for JP1/AJS3 - Manager installed on another host.
- If you specify an execution host name in the `-s` option and the name cannot be resolved from the manager host, the command might take a long time to execute.
- When adding an execution host to an execution agent, the name of the execution host must be correctly resolved before you execute the command. Set the execution host name in the `hosts` file or DNS before executing the command. For details on name resolution, see *2.2.2(4) Notes on manager/agent system configurations* in the *JP1/Automatic Job Management System 3 System Design (Configuration) Guide*.
- Consecutive single-byte space characters at the end of explanatory text might become invalid. Do not end explanatory text with single-byte space characters.

- The maximum number of `ajsagtadd`, `ajsagtal`, and `ajsagtdel` commands that can be executed concurrently on the same host is five. If you attempt to execute more than five commands, the commands terminate abnormally.

Return values

| | |
|-----|--|
| 0 | Normal end. |
| 4 | <ul style="list-style-type: none"> • An environment variable used for command execution is incorrect. • The JP1/AJS3 service is not running. • The <code>-h</code> option is specified but the specified logical host does not exist or environment settings are incorrect. • A execution agent whose name is the same as the target host you attempted to add already exists. • The maximum number of execution agents that can be defined is exceeded. • The maximum number of execution agent groups that can be defined is exceeded. • The authentication server is not running. • An error occurred in communication with the JP1/AJS3 service. |
| 8 | An argument specified in the command is incorrect. |
| 12 | Memory became insufficient during command processing. |
| 20 | An attempt to access shared memory failed because the access target was locked. |
| 24 | Permission to execute the command is not granted. |
| 28 | The contents of the execution agent definition file are incorrect. |
| 36 | An error occurred while the command was accessing the execution agent definition file. |
| 40 | A system limit was exceeded during allocation of shared memory, file descriptors, or resources for exclusive use. |
| 120 | <ul style="list-style-type: none"> • An unexpected error was detected for an OS system call. • The database area is not enough. Alternatively, secondary allocation of the database area failed. • An attempt to access the database or failed because the access target was locked. • A database input or output error occurred. |
| 124 | An unexpected error was detected in JP1/AJS internal processing. |

Additional information

The following shows examples of specifying the maximum number of concurrently executable jobs:

- To set 1 as the maximum number of concurrently executable jobs for the time period from 1:00 to 5:00, specify the following:
`-c 01:00-05:00=1`
- To set 1 as the maximum number of concurrently executable jobs for the time period from 23:00 to 24:00, specify the following:
`-c 23:00-00:00=1`
 To indicate 24:00, specify `00:00` or `0:0`.
- To set 1 as the maximum number of concurrently executable jobs for the time period from 23:00 to 24:00 and the time period from 00:00 to 05:00 on the next day, specify the following:
`-c 23:00-05:00=1`
 You can specify a time period that is across two days.
- To set 1 as the maximum number of concurrently executable jobs for all day, specify the following:
`-c 00:00-00:00=1`

Specifying the execution agent definition file settings

The following are general rules that apply when you specify the execution agent definition file settings:

- You can use one execution agent definition file to specify both execution agents and execution agent groups.
- A single execution agent or execution agent group is entered on one line, and each element of one entry is separated with a comma (,). If you specify multiple entries, make sure that each entry is specified on a separate line.
- A line beginning with a hash mark (#) is handled as a comment.
- A blank line is ignored.
- Each element of an entry must be enclosed in double quotation marks ("").
- No elements of an entry can be omitted. If you do not want to specify a value for an element, enter "".

The following describes how you can specify execution agents and execution agent groups in the file.

Specifying execution agents

Format

```
"flag", "execution-agent-name", "target-host-system-name", "maximum-number-of-concurrently-executable-jobs", "job-transfer-restriction-status", "description"
```

Arguments

- *flag*
Specify A, which indicates an execution agent definition.
- *execution-agent-name*
Specify the name of an execution agent you want to add.
You can specify a character string of 1 to 255 bytes.
You cannot omit this element.
- *target-host-system-name*
Specify the execution host name.
You can specify a character string of 1 to 255 bytes.
If you omit this element, the execution agent name is assumed.
- *maximum-number-of-concurrently-executable-jobs*
Specify a time period and the maximum number of concurrently executable jobs for the time period.
The time period is specified by using the start and end times separated by a hyphen (-). Both times are specified in *hh:mm* format where *mm* is specified in units of 30 minutes.
For *hh*, you can specify 0 or a value in the range from 00 to 23 (hours).
For *mm*, you can specify 0, 00, or 30 (minutes).
For *maximum-number-of-concurrently-executable-jobs*, you can specify a value from 0 to 4,294,967,295.
If this option is omitted, 00:00-00:00=5, which applies 5 as the maximum number of concurrently executable jobs for all day, is assumed.
You can specify multiple combinations of time period and maximum number of concurrently executable jobs. To do this, use a comma (,) to separate each occurrence of *time-time=maximum-number-of-concurrently-executable-jobs*.
- *job-transfer-restriction-status*
Use any of the following values to specify the job transfer restriction status of the execution agent to be added:

| Value | Status | Description |
|-------|-------------|--|
| Ef | Effective | Jobs are accepted and then delivered to the target host. |
| In | Ineffective | New jobs are not accepted but the jobs that have already been accepted are delivered to the target host. |
| Hd | Hold | Jobs are accepted but are not delivered to the target host. |
| Bl | Blockade | Jobs are neither accepted nor delivered to the target host. |

If you omit this option, the system assumes Ef.

- *description*

Write text as a description on the execution agent to be added.

You can specify a character string of 1 to 80 bytes.

Example of coding

This example shows an entry that adds an execution agent under the following conditions:

- execution-agent-name: AGT01
- target host system name: HOST01
- maximum number of concurrently executable jobs: 10 for the time period from 0:00 to 12:00, and 20 for the time period from 12:00 to 0:00
- job-transfer-restriction-status: Jobs are neither accepted nor delivered to the target host.
- description: AGT01 execution-agent

```
"A", "AGT01", "HOST01", "00:00-12:00=10,12:00-00:00=20", "Bl", "AGT01 execution-agent"
```

Specifying execution agent groups

Format

```
"flag", "execution-agent-group-name", "connection-destination-execution-agent-and-priority", "job-transfer-restriction-status", "description"
```

Arguments

- *flag*

Specify G, which indicates an execution agent group definition.

- *execution-agent-group-name*

Specify the name of an execution agent group you want to add.

You can specify a character string of 1 to 255 bytes.

You cannot omit this element.

- *connection-destination-exec-target-and-priority*

Specify the name of an execution agent to be associated with the execution agent group. Following the execution agent name, you can also specify the priority of the execution agent in the execution agent group. If you specify the priority, place a colon (:) as a separator between the execution agent name and the priority.

Make sure that you specify an execution agent name that has already been registered.

You can use 1 to 255 bytes to specify an execution agent name.

As the priority value, you can specify 1 to 16 where 1 is lowest and 16 is highest. A job with a higher priority value is executed earlier.

If you want to associate multiple execution agents to the execution agent group, specify multiple occurrences of *exec-agent-name* [:*priority*] by using a comma (,) to separate each occurrence, without inserting a space.

The maximum number of execution agents that can be associated is 1,024 (or 2,048 if the value of the environment setting parameter AGENTLIMITEXTEND is 2).

If you omit this element, the execution agent to be associated with the execution agent group is not set.

- *job-transfer-restriction-status*

Use any of the following values to specify the job transfer restriction status of the execution agent group to be added:

| Value | Status | Description |
|-------|-------------|--|
| Ef | Effective | Jobs are accepted and then delivered to the target host. |
| In | Ineffective | New jobs are not accepted but the jobs that have already been accepted are delivered to the target host. |
| Hd | Hold | Jobs are accepted but are not delivered to the target host. |
| Bl | Blockade | Jobs are neither accepted nor delivered to the target host. |

If you omit this option, the system assumes Ef.

- *description*

Write text as a comment on the execution agent group to be added. You can specify a character string of 1 to 80 bytes.

Example of coding

This example shows an entry that adds an execution agent group under the following conditions:

- *execution-agent-group-name*: AGTGRP01
- *connection-destination-execution-agent* and *priority*: AGT01(priority: 1), AGT02(priority: none)
- *job-transfer-restriction-status*: Jobs are accepted but are not delivered to the target host.
- *description*: AGTGRP01 execution-agent-group

```
"G", "AGTGRP01", "AGT01:1,AGT02", "Hd", "AGTGRP01 execution-agent-group"
```

Example 1

To add an execution agent with the same name as target host AP1, execute the following command:

```
ajsagtadd -a AP1
```

Example 2

To add an execution agent whose name is AP1 and whose maximum number of concurrently executable jobs for the time period from 01:00 to 05:00 is 1, execute the following command:

```
ajsagtadd -a AP1 -c 01:00-05:00=1
```

Example 3

To add execution agent group APG1 that contains execution agents AP1 (with a priority of 16), AP2 (with the default priority), and AP3 (with a priority of 5), execute the following command:

```
ajsagtadd -g APG1 -l AP1:16,AP2,AP3:5
```

ajsagtalt

Format

```
ajsagtalt
  [-h logical-host-name]
  {-a execution-agent-name
   [-s execution-host-name]
   [-c time-time=maximum-number-of-concurrently-executable-jobs,...]
   [-d description] |
  -a execution-agent-name -t {e|i|h|b} |
  -g execution-agent-group-name -d comment |
  -g execution-agent-group-name -l execution-agent-name[:priority] |
  -g execution-agent-group-name -m execution-agent-name[:priority] |
  -g execution-agent-group-name -u execution-agent-name |
  -g execution-agent-group-name -t {e|i|h|b} |
  -a execution-agent-name -e {u|m}}
```

Format1 (for changing the execution agent settings)

```
ajsagtalt
  [-h logical-host-name]
  -a execution-agent-name
  [-s exec-host-name]
  [-c time-time=maximum-number-of-concurrently-executable-jobs,...]
  [-d description]
```

Format2 (for changing the execution agent group settings)

```
ajsagtalt
  [-h logical-host-name]
  -g execution-agent-group-name
  -d description
```

Format3 (for adding an execution agent to an execution agent group)

```
ajsagtalt
  [-h logical-host-name]
  -g execution-agent-group-name
  -l execution-agent-name[:priority]
```

Format4 (for changing the priority of an execution agent in an execution agent group)

```
ajsagtalt
  [-h logical-host-name]
  -g execution-agent-group-name
  -m execution-agent-name[:priority]
```

Format5 (for removing an execution agent from an execution agent group)

```
ajsagtalt
  [-h logical-host-name]
  -g execution-agent-group-name
  -u execution-agent-name
```

Format6 (for changing the job transfer restriction status of an execution agent)

```
ajsagtalt
  [-h logical-host-name]
  -a execution-agent-name
  -t {e|i|h|b}
```

Format7 (for changing the job transfer restriction status of an execution agent group)

```
ajsagtalt
  [-h logical-host-name]
  -g execution-agent-group-name
  -t {e|i|h|b}
```

Format8 (for changing the status of an execution agent)

```
ajsagtalt
  [-h logical-host-name]
  -a execution-agent-name
  -e {u|m}
```

Description

The `ajsagtalt` command changes the settings of an execution agent or execution agent group, or changes the job transfer restriction status of an execution agent or execution agent group.

Execution privileges

This command can be executed by a user at either of the following JP1 permission levels:

- JP1_JPQ_Admin privilege
- JP1_JPQ_Operator privilege

Users at this permission level can only perform either of the following operations:

- Changing the job transfer restriction status of an execution agent or execution agent group (`-t` option).
- Changing the status of an execution agent (`-e` option).

Arguments

`-h` *logical-host-name*

Specify the logical host name of the local host on which the execution agent or execution agent group whose settings you want to change is registered.

You can specify a character string of 1 to 255 bytes.

If this option is omitted, the logical host name specified in the `JP1_HOSTNAME` environment variable is assumed. If the `JP1_HOSTNAME` environment variable is not specified, the physical host name is assumed.

For a physical host, make sure that you specify neither this option nor the `JP1_HOSTNAME` environment variable.

`-a` *execution-agent-name*

Specify the name of the execution agent whose settings you want to change.

You can specify a character string of 1 to 255 bytes.

-g *execution-agent-group-name*

Specify the name of the execution agent group whose settings you want to change.

You can specify a character string of 1 to 255 bytes.

-s *exec-host-name*

Specify the execution host name (agent host name).

You can specify a character string of 1 to 255 bytes.

You can specify this option only if the `-a` option is specified.

The name of the execution host to be specified must be resolved correctly. Before executing the command, set the name of the execution host to be specified in the `hosts` file or on a DNS server. If an execution host name that a manager host cannot resolve is specified, command execution might take a long time.

For details about name resolution, see *2.2.2(4) Notes on manager/agent system configurations* in the *JPI/Automatic Job Management System 3 System Design (Configuration) Guide*.

-c *time-time=maximum-number-of-concurrently-executable-jobs, . . .*

Specify the time periods for which you want to change the maximum number of concurrently executable jobs, together with the new values for the maximum number of concurrently executable jobs.

By specifying the maximum number of concurrently executable jobs, you can limit the number of jobs that can concurrently be executed on this execution agent. The specified limit is applied to UNIX, PC, flexible, HTTP connection, action, custom, and passing information setting jobs. If an attempt is made to execute a job when the number of concurrently executing jobs has already reached the maximum, the job is queued to wait until the number of concurrently executing jobs becomes smaller than the maximum.

The time period is specified by using the start and end times separated by a hyphen (`-`). Both times are specified in `hh:mm` format where `mm` is specified in units of 30 minutes.

For `hh`, you can specify 0 or a value in the range from 00 to 23 (hours).

For `mm`, you can specify 0, 00, or 30 (minutes).

For *maximum-number-of-concurrently-executable-jobs*, you can specify a value from 0 to 4,294,967,295.

You can specify multiple combinations of time period and maximum number of concurrently executable jobs. To do this, use a comma (`,`) to separate each occurrence of *time-time=maximum-number-of-concurrently-executable-jobs* without inserting a space. You can specify a maximum of 48 time periods. If you specify overlapping time periods, the last specified value takes effect for the maximum number of concurrently executable jobs. For example, if you specify `-c 1:00-2:30=5, 2:00-4:00=10`, the time period from 2:00 to 2:30 overlaps. For this time period, 10 is applied as the maximum number of concurrently executable jobs.

For time periods that are not specified, the maximum number of concurrently executable jobs is not changed.

If the command is executed during a specified time period, the maximum number of concurrently executable jobs for the time period is immediately changed.

You can specify this option only if the `-a` option is specified.

-d *description*

Specify a comment on the execution agent or execution agent group.

You can specify a character string of 1 to 80 bytes.

You can specify this option only if the `-a` or `-g` option is specified.

-l *execution-agent-name* [: *priority*]

Specify the name of an execution agent to be associated with the execution agent group. Following the execution agent name, you can also specify the priority of the execution agent in the execution agent group. If you specify the priority, place a colon (`:`) as a separator between the execution agent name and the priority.

Make sure that you specify an execution agent name that has already been registered.

You can use 1 to 255 bytes to specify an execution agent name.

As the priority value, you can specify 1 to 16 where 1 is lowest and 16 is highest. A job with a higher priority value is executed earlier. If the priority is omitted, 16 is assumed.

You can specify this option only if the `-g` option is specified.

-m *execution-agent-name* [: *priority*]

Specify this option if you want to change the priority of an execution agent in the execution agent group. Specify the execution agent name and the new priority with an intervening colon (`:`).

You can use 1 to 255 bytes to specify the execution agent name.

As the priority value, you can specify 1 to 16 where 1 is lowest and 16 is highest. A job with a higher priority value is executed earlier. If the priority is omitted, 16 is assumed.

You can specify this option only if the `-g` option is specified.

-u *execution-agent-name*

Specify the name of an execution agent you want to remove from the execution agent group.

You can specify a character string of 1 to 255 bytes.

You can specify this option only if the `-g` option is specified.

-t {*e|i|h|b*}

Specify this option if you want to change the job transfer restriction status of an execution agent or execution agent group to be added.

| Value | Status | Description |
|-------|-------------|--|
| e | Effective | Jobs are accepted and then delivered to the target host. |
| i | Ineffective | New jobs are not accepted but the jobs that have already been accepted are delivered to the target host. |
| h | Hold | Jobs are accepted but are not delivered to the target host. |
| b | Blockade | Jobs are neither accepted nor delivered to the target host. |

You can specify this option only if the `-a` or `-g` option is specified.

-e {u|m}

Specify this option to change the status of an execution agent. You cannot change the status to *Connectable* or *Unconnectable*.

| Value | Status | Description |
|-------|-------------|--|
| u | Not checked | The communication status will be checked. After the check is completed, the status will change to <i>Connectable</i> or <i>Unconnectable</i> . |
| m | Unavailable | Suppress job distribution. |

This option can be executed only when the job distribution delay reduction function is enabled. If this function is disabled, an error occurs.

If you stop the JP1/AJS3 service when the status of the execution agent is not *Unavailable*, the status changes to *Not checked*.

If you add an execution agent by using the `ajsagtadd` command or by using the automatic agent definition function, the status of the added execution agent will be *Not checked*.

If you change the execution host name by using the `-s` option, the status of the execution agent is set to *Not checked*. However, if the execution host name is set again to the same host name, the status is not changed. The execution host name field is not case sensitive.

If different execution agents are registered on the same execution host, you need to execute the command for each execution agent.

Notes

- The maximum number of concurrently executable jobs, the job transfer restriction status, and the execution agent priority specified by this command are not applied to event jobs and custom event jobs.
- This command cannot be used for a request from JP1/AJS3 to JP1/OJE for VOS3.
- This command cannot be executed for JP1/AJS3 - Manager installed on another host.
- If any jobs (PC jobs, Unix jobs, flexible jobs, HTTP connection jobs, custom jobs, or action jobs) are running, you must include an execution agent in an execution agent group.
- If any jobs (PC jobs, Unix jobs, flexible jobs, HTTP connection jobs, custom jobs, action jobs, event jobs, or custom event jobs) are running, you cannot change the execution host.
- You cannot change the execution host used as the default execution agent (named @SYSTEM). For details about the default execution agent, see *5.1.4 Default execution agent* in the manual *JP1/Automatic Job Management System 3 Overview*.
- Consecutive single-byte space characters at the end of explanatory text might become invalid. Do not end explanatory text with single-byte space characters.
- When a command with the `-u` option specified is being executed, if a job is executed in an execution agent in the execution agent group specified by the `-g` option, start of the job execution might be delayed (in a queuing state) by a maximum of 20 seconds depending on timing. For this reason, execute the command when no job in a queuing state exists in the execution agent group specified by the `-g` option.
- The maximum number of `ajsagtadd`, `ajsagtalt`, and `ajsagtdel` commands that can be executed concurrently on the same host is five. If you attempt to execute more than five commands, the commands terminate abnormally.

Return values

| | |
|-----|---|
| 0 | Normal end. |
| 4 | <ul style="list-style-type: none">• An environment variable used for command execution is incorrect.• The JP1/AJS3 service is not running.• The <code>-h</code> option is specified but the specified logical host does not exist or environment settings are incorrect.• The specified execution agent does not exist.• The specified execution agent group does not exist.• The authentication server is not running.• A job is running.• An error occurred in communication with the JP1/AJS3 service.• When the <code>-e</code> option was specified, the job distribution delay reduction function was disabled. |
| 8 | An argument specified in the command is incorrect. |
| 12 | Memory became insufficient during command processing. |
| 16 | File capacity is insufficient. |
| 20 | An attempt to access shared memory failed because the access target was locked. |
| 24 | Permission to execute the command is not granted. |
| 40 | A system limit was exceeded during allocation of shared memory, file descriptors, or resources for exclusive use. |
| 120 | <ul style="list-style-type: none">• An unexpected error was detected for an OS system call.• The database area is not enough. Alternatively, secondary allocation of the database area failed.• An attempt to access the database failed because the access target was locked.• A database input or output error occurred. |
| 124 | An unexpected error was detected in JP1/AJS internal processing. |

Example 1

To change the maximum number of concurrently executable jobs to 1 for the time period from 1:00 to 5:00 on execution agent AP1, execute the following command:

```
ajsagtalt -a AP1 -c 01:00-05:00=1
```

Example 2

To add execution agent AP2 (with a priority of 1) to execution agent group APG1, execute the following command:

```
ajsagtalt -g APG1 -l AP2:1
```

Example 3

To remove execution agent AP3 from execution agent group APG1, execute the following command:

```
ajsagtalt -g APG1 -u AP3
```

Example 4

To change the status of execution agent AP1 to *Unavailable*, execute the following command:

```
ajsagtalt -a AP1 -e m
```

ajsagtcheck

Format

```
ajsagtcheck
  [-h logical-host-name]
  [-m { start | stop | status }]
```

Description

The `ajsagtcheck` command starts and stops the communication status check for the job distribution delay reduction function, and outputs the status for all execution agents other than the execution agents whose status is *Unavailable*.

You can execute this command only when the job distribution delay reduction function is enabled. If this function is disabled, the command is interrupted and then an error message appears.

Execution privileges

In Windows: Administrators privilege

In UNIX: Superuser privilege

Arguments

-h *logical-host-name*

Specify the name of the logical host on which the execution agent whose communication status you want to check is registered.

You can specify a character string of 1 to 255 bytes.

If this option is omitted, the logical host name specified in the `JP1_HOSTNAME` environment variable is assumed. If the `JP1_HOSTNAME` environment variable is not specified, the physical host name is assumed.

-m { **start** | **stop** | **status** }

Specify the operation for the job distribution delay reduction function. You can specify the following values:

If you omit this option, the system assumes `status`.

- `start`

Starts a communication status check.

If a communication error is detected for the execution agent during a communication status check, a communication recovery check is performed.

Note that you cannot check the communication status of an execution agent whose status has been set to *Not available* by the `ajsagtalt` command.

If a communication status check is already running, the command is interrupted and then an error message appears. The communication status check continues.

- `stop`

Stops a communication status check. However, the communication recovery check continues for an execution agent on which a communication error has been detected.

If a communication status check is not running, the command is interrupted and then an error message appears.

- status

Outputs the following items to the standard output:

- The time when a communication status check was performed
- The time when a communication status recovery check is performed
- Progress of communication status checks or communication recovery checks in progress (number of execution agents by status)

For details about the output format, see the output example.

Return values

| | |
|-----|--|
| 0 | Normal end. |
| 4 | <ul style="list-style-type: none"> • An environment variable used for command execution is incorrect. • The JP1/AJS3 service is not running. • The -h option is specified but the specified logical host does not exist or environment settings are incorrect. • The host is now being started, now being stopped, has stopped, or is running in reduced-operation mode. • The job distribution delay reduction function is disabled. • The agent monitoring process is being stopped. • No operable status was returned. |
| 8 | An argument specified in the command is incorrect. |
| 12 | Memory became insufficient during command processing. |
| 20 | An attempt to access shared memory failed because the access target was locked. |
| 24 | Permission to execute the command is not granted. |
| 36 | <ul style="list-style-type: none"> • An error occurred in communication with the JP1/AJS3 service, or the JP1/AJS3 service returned no response. • An error occurred in communication with the agent monitoring process, or the agent monitoring process returned no response. |
| 40 | A system limit was exceeded during allocation of shared memory, file descriptors, or resources for exclusive use. |
| 120 | An unexpected error was detected for an OS system call. |
| 124 | An unexpected error was detected in JP1/AJS internal processing. |

Example 1

To start a communication status check for an execution agent on a physical host, execute the following command:

```
ajsagtcheck -m start
```

Example 2

To view the status of a communication status check for an execution agent on a logical host (lhost1), execute the following command:

```
ajsagtcheck -h lhost1 -m status
```

Output example

The following shows a sample execution of the command with status specified for the -m option:

```

ajsagtcheck -m status
KNAC1202-I The output of the agent monitoring information will now start.
HOSTNAME:HOST01

CONNECT
START TIME : 2016/02/02 10:10:05
END TIME : 2016/02/02 10:11:10

RECOVERY
START TIME : 2016/02/02 11:20:04
END TIME : 2016/02/02 11:20:35

CONNECTABLE UNCONNECTABLE NOT CHECKED UNAVAILABLE
-----
100 5 0 4
KNAC1203-I The output of the agent monitoring information will now end.

```

The following shows the meaning of the output.

HOSTNAME

Indicates a host name.

For a physical host, the local host name is displayed. For a logical host, the name of the logical host is output.

CONNECT

- START TIME
Indicates the start time of the communication status check in *YYYY/MM/DD hh:mm:ss* format.
- END TIME
Indicates the end time of the communication status check in *YYYY/MM/DD hh:mm:ss* format.
If the communication status check is running, *----/--/--* is displayed.

RECOVERY

- START TIME
Indicates the start time of the communication recovery check in *YYYY/MM/DD hh:mm:ss* format.
- END TIME
Indicates the end time of the communication recovery check in *YYYY/MM/DD hh:mm:ss* format.
If the communication recovery check is running, *----/--/--* is displayed.

CONNECTABLE

Indicates the number of execution agents in *Connectable* status.

UNCONNECTABLE

Indicates the number of execution agents in *Unconnectable* status.

NOT CHECKED

Indicates the number of execution agents in *Not checked* status.

UNAVAILABLE

Indicates the number of execution agents in *Unavailable* status.

ajsagtdel

Format

```
ajsagtdel
  [-h logical-host-name]
  {-a execution-agent-name | -g execution-agent-group-name}
```

Format1 (for deleting an execution agent)

```
ajsagtdel
  [-h logical-host-name]
  -a execution-agent-name
```

Format2 (for deleting an execution agent group)

```
ajsagtdel
  [-h logical-host-name]
  -g execution-agent-group-name
```

Description

Deletes an execution agent or execution agent group.

Execution privileges

This command can be executed by a user at the following JP1 permission level:

- JP1_JPQ_Admin privilege

Arguments

-h *logical-host-name*

Specify the logical host name of the local host on which the execution agent or execution agent group you want to delete is registered.

You can specify a character string of 1 to 255 bytes.

If this option is omitted, the logical host name specified in the JP1_HOSTNAME environment variable is assumed. If the JP1_HOSTNAME environment variable is not specified, the physical host name is assumed.

For a physical host, make sure that you specify neither this option nor the JP1_HOSTNAME environment variable.

-a *execution-agent-name*

Specify the name of an execution agent you want to delete.

You can specify a character string of 1 to 255 bytes.

-g *execution-agent-group-name*

Specify the name of an execution agent group you want to delete.

You can specify a character string of 1 to 255 bytes.

Notes

- Before you execute `ajsagtdel` command, use the `ajsagtal` command to change the job transfer restriction status of the execution agent you want to delete to *Blocked* so that jobs are not executed on the agent. For details about the job transfer restriction status of an execution agent, see *5.2 Restricting job transfer* in the manual *JP1/Automatic Job Management System 3 Overview*.

Note that the job transfer restriction status of an execution agent has no effect on event jobs and custom event jobs. Therefore, ensure that a new event job, custom event job or jobnet with start conditions is not executed on the execution agent to be deleted.

You cannot delete an execution agent on which a job (PC, UNIX, custom, flexible, HTTP connection, action, event, or custom event job) is running. To delete an execution agent on which a job is running, you must forcibly terminate the job.

You can use the `ajsagtshow` command to check for jobs that are running. For details on the `ajsagtshow` command, see *ajsagtshow* in *3. Commands Used for Normal Operations*.

- If you execute `ajsagtdel` command on a target host on which an event job, a custom event job or a jobnet with start conditions was executed, the target host remembers the manager host name that executed `ajsagtdel` command. If the target host remembers the manager host name, the host performs communication with the manager host to report that the host has started or stopped. Because this communication is unnecessary, use the following procedure to delete the manager host name that executed `ajsagtdel` command.

To delete the manager host name remembered by the target host you want to delete:

1. Check whether the target host remembers the manager host name that executed `ajsagtdel` command.

To do this, on the target host, execute the following command:

```
jpoagoec -p [-h logical-host-name]#
```

2. Delete the manager host name that executed `ajsagtdel` command.

Execute the following command:

```
jpoagoec [-h logical-host-name]# -d manager-host-name-that-executed-ajsagtdel-command
```

#

You do not need to specify the `-h` option if the manager host targeted by the command is a physical host.

For details on the `jpoagoec` command, see *jpoagoec* in *3. Commands Used for Normal Operations*.

- Do not perform the following operations while an event job, a custom event job or a jobnet with a start condition is running:
 - Stop the OS before stopping the JP1/AJS3 service on the execution host for the execution agent.
 - Turn off the target host system acting as the execution agent.

If you execute `ajsagtdel` command after performing either of these operations, the specified execution agent cannot be deleted. If this occurs, stop and cold start the JP1/AJS3 service on the manager host or delete information about event jobs, custom event jobs or jobnets with start conditions being executed on the execution agent, and then execute `ajsagtdel` command again.

To delete information about event jobs, custom event jobs or jobnets with start conditions being executed on the execution agent:

1. For each scheduler service, check whether there are any event jobs being executed, custom event jobs being executed or jobnets with start conditions being monitored by the execution agent in question.

Execute the following command:

```
jpomanejshow [-h logical-host-name]# -F scheduler-service-name -a execution-agent-name
```

2. Stop the scheduler service you identified in step 1.

- From the scheduler service you stopped in step 2, delete the information for the event job being executed, custom event job being executed or jobnet with start conditions being monitored by the execution agent in question.

Execute the following command:

```
jpomanevreset [-h logical-host-name]# -F scheduler-service-name -a execution-agent-name -s
#
```

You do not need to specify the `-h` option if the manager host targeted by the command is a physical host.

For details on how to stop a scheduler service, see [7.5.2 Stopping the scheduler service](#) in the *JP1/Automatic Job Management System 3 Administration Guide*. For details on the `jpomanjobshow` command, see [jpomanjobshow in 3. Commands Used for Normal Operations](#), and for details on the `jpomanevreset` command, see [jpomanevreset in 3. Commands Used for Normal Operations](#).

- `ajsagtdel` command cannot be used for a request from JP1/AJS3 to JP1/OJE for VOS3.
- `ajsagtdel` command cannot be executed for JP1/AJS3 - Manager installed on another host.
- The maximum number of `ajsagtadd`, `ajsagtalt`, and `ajsagtdel` commands that can be executed concurrently on the same host is five. If you attempt to execute more than five commands, the commands terminate abnormally.

Return values

| | |
|-----|---|
| 0 | Normal end. |
| 4 | <ul style="list-style-type: none"> An environment variable used for command execution is incorrect. The JP1/AJS3 service is not running. The <code>-h</code> option is specified but the specified logical host does not exist or environment settings are incorrect. The specified execution agent does not exist. The specified execution agent group does not exist. The target host cannot be deleted because a job is being executed. The authentication server is not running. The specified execution agent cannot be deleted because it is connected from an execution agent group. The execution agent or execution agent group cannot be deleted because the job transfer restriction status is not <i>Blocked</i>. An error occurred in communication with the JP1/AJS3 service. |
| 8 | An argument specified in the command is incorrect. |
| 12 | Memory became insufficient during command processing. |
| 20 | An attempt to access shared memory failed because the access target was locked. |
| 24 | Permission to execute the command is not granted. |
| 40 | A system limit was exceeded during allocation of shared memory, file descriptors, or resources for exclusive use. |
| 120 | <ul style="list-style-type: none"> An unexpected error was detected for an OS system call. The database area is not enough. Alternatively, secondary allocation of the database area failed. An attempt to access the database failed because the access target was locked. A database input or output error occurred. |
| 124 | An unexpected error was detected in JP1/AJS internal processing. |

Example 1

To delete execution agent AP1, execute the following command:

```
ajsagtdel -a AP1
```

Example 2

To delete execution agent group APG1, execute the following command:

```
ajsagt del -g APG1
```

ajsagtprint

Format

```
ajsagtprint
  [-h logical-host-name]
  {-a execution-agent-name | -g execution-agent-group-name | -l}
```

Format1 (for outputting the execution agent definition)

```
ajsagtprint
  [-h logical-host-name]
  -a execution-agent-name
```

Format2 (for outputting the execution agent group)

```
ajsagtprint
  [-h logical-host-name]
  -g execution-agent-group-name
```

Format3 (for outputting the definition information of all execution agents and execution agent groups)

```
ajsagtprint
  [-h logical-host-name]
  -l
```

Description

The `ajsagtprint` command outputs the definition information of execution agents or execution agent groups to the standard output file in CSV format.

Execution privileges

You must have any of the following JP1 privileges:

- JP1_JPQ_Admin privilege
- JP1_JPQ_Operator privilege
- JP1_JPQ_User privilege

or

In Windows: Administrators privilege

In UNIX: Superuser privileges

Arguments

-h *logical-host-name*

Specify the logical host name of the local host on which the execution agents or execution agent groups whose definition information you want to output are registered.

You can specify a character string of 1 to 255 bytes.

If this option is omitted, the logical host name specified in the JP1_HOSTNAME environment variable is assumed. If the JP1_HOSTNAME environment variable is not specified, the physical host name is assumed.

For a physical host, make sure that you specify neither this option nor the JP1_HOSTNAME environment variable.

-a execution-agent-name

If you want to output the definition information of a specific execution agent, specify the name of the execution agent.

You can specify a character string of 1 to 255 bytes.

-g execution-agent-group-name

If you want to output the definition information of a specific execution agent group, specify the name of the execution agent group.

You can specify a character string of 1 to 255 bytes.

-1

Specify this option if you want to output the definition information for all execution agents and execution agent groups.

Note

- This command cannot be used for a request from JP1/AJS3 to JP1/OJE for VOS3.
- This command cannot be executed for JP1/AJS3 - Manager installed on another host.

Return values

| | |
|-----|---|
| 0 | Normal end. |
| 4 | <ul style="list-style-type: none">• An environment variable used for command execution is incorrect.• The JP1/AJS3 service is not running.• The -h option is specified but the specified logical host does not exist or environment settings are incorrect.• The specified execution agent does not exist.• The specified execution agent group does not exist.• The authentication server is not running. |
| 8 | An argument specified in the command is incorrect. |
| 12 | Memory became insufficient during command processing. |
| 20 | An attempt to access shared memory failed because the access target was locked. |
| 24 | Permission to execute the command is not granted. |
| 40 | A system limit was exceeded during allocation of shared memory, file descriptors, or resources for exclusive use. |
| 120 | An unexpected error was detected for an OS system call. |
| 124 | An unexpected error was detected in JP1/AJS internal processing. |

Example 1

In the following example, the command outputs the definition information for execution agent AP1.

```
ajsagtprint -a AP1
```

Example 2

In the following example, the command displays the information about all execution agents or execution agent groups.

```
ajsagtprint -l
```

Output example 1

The following shows a sample execution of the command with the `-a` option specified:

```
ajsagtprint -a AP1  
  
# <time-stamp> HOSTNAME:<host-name#1>  
#,AGENT,HOST,CON-EXE,STATUS,DESCRIPTION  
"A","AP1","Host1","1:00-3:00=10","Ef","Agent1"
```

#1

For a physical host, the local host name is displayed. For a logical host, the name of the logical host is output.

The following shows the meaning of the output.

flag

- #: Indicates a comment line.
- A: Indicates the definition information of an execution agent.

AGENT

Indicates that execution agent names are output in this column.

HOST

Indicates that target host names (agent host names) are output in this column.

CON-EXE

Indicates that the maximum number of concurrently executable jobs is output in this column.

STATUS

Indicates the job transfer restriction status of the execution agent.

| Value | Status | Description |
|-------|-------------|--|
| Ef | Effective | Jobs are accepted and then delivered to the target host. |
| In | Ineffective | New jobs are not accepted but the jobs that have already been accepted are delivered to the target host. |
| Hd | Hold | Jobs are accepted but are not delivered to the target host. |
| B1 | Blockade | Jobs are neither accepted nor delivered to the target host. |

DESCRIPTION

Indicates that the comment on the execution agent is output in this column.

Output example 2

The following shows a sample execution of the command with the `-g` option specified:

```
ajsagtprint -g AGG1

# <time-stamp> HOSTNAME:<host-name#1>
#,AGENT GROUP, LINK AGENT, STATUS, DESCRIPTION
"G", "AGG1", "AG1:1", "Ef", "AgentGroup1"
```

#1

For a physical host, the local host name is displayed. For a logical host, the name of the logical host is output.

The following shows the meaning of the output.

flag

- #: Indicates a comment line.
- G: Indicates the definition information of an execution agent group.

AGENT GROUP

Indicates that execution agent group names are output in this column.

LINK AGENT

Indicates that the name and priority of the execution agent in the execution agent group are output in this column.

STATUS

Indicates the job transfer restriction status of the execution agent group.

| Value | Status | Description |
|-------|-------------|--|
| Ef | Effective | Jobs are accepted and then delivered to the target host. |
| In | Ineffective | New jobs are not accepted but the jobs that have already been accepted are delivered to the target host. |
| Hd | Hold | Jobs are accepted but are not delivered to the target host. |
| B1 | Blockade | Jobs are neither accepted nor delivered to the target host. |

DESCRIPTION

Indicates that the comment on the execution agent group is output in this column.

ajsagtshow

Format

```
ajsagtshow
  [-h logical-host-name]
  {-a execution-agent-name | -g execution-agent-group-name|-l|-n|-e}
```

Format1 (for displaying information about an execution agent)

```
ajsagtshow
  [-h logical-host-name]
  -a execution-agent-name
```

Format2 (for displaying information about an execution agent group)

```
ajsagtshow
  [-h logical-host-name]
  -g execution-agent-group-name
```

Format3 (for displaying information about all execution agents and execution agent groups)

```
ajsagtshow
  [-h logical-host-name]
  -l
```

Format4 (for displaying the names of all execution agents and execution agent groups)

```
ajsagtshow
  [-h logical-host-name]
  -n
```

Format5 (for displaying information about the status of execution agents)

```
ajsagtshow
  [-h logical-host-name]
  -e
```

Description

The `ajsagtshow` command outputs the job execution status and other information about execution agents or execution agent groups to the standard output.

Execution privileges

You must have any of the following JP1 privileges:

- JP1_JPQ_Admin privilege
- JP1_JPQ_Operator privilege
- JP1_JPQ_User privilege

or

In Windows: Administrators privilege

In UNIX: Superuser privileges

Arguments

-h *logical-host-name*

Specify the logical host name of the local host on which the execution agent or execution agent group for which you want to output execution agent information is registered.

You can specify a character string of 1 to 255 bytes.

If this option is omitted, the logical host name specified in the JP1_HOSTNAME environment variable is assumed. If the JP1_HOSTNAME environment variable is not specified, the physical host name is assumed.

For a physical host, make sure that you specify neither this option nor the JP1_HOSTNAME environment variable.

-a *execution-agent-name*

Specify the name of an execution agent for which you want to output execution agent information.

You can specify a character string of 1 to 255 bytes.

If the job distribution delay reduction function is enabled, the status of the execution agent is also output.

-g *execution-agent-group-name*

Specify the name of an execution agent group for which you want to output execution agent information.

You can specify a character string of 1 to 255 bytes.

If the job distribution delay reduction function is enabled, the status of the execution agent is also output.

-l

Specify this option if you want to output the information for all execution agents and execution agent groups.

If the job distribution delay reduction function is enabled, the status of the execution agent is also output.

-n

Specify this option if you want to output only the names of all execution agents and execution agent groups. If this option is specified, information other than the names of execution agents and execution agent groups is not output.

-e

Specify this option if you want to output the status of execution agents.

You can specify this option only when the job distribution delay reduction function is enabled. If this function is disabled, the command is interrupted and then an error message appears.

Notes

- This command cannot be used for a request from JP1/AJS3 to JP1/OJE for VOS3.
- This command cannot be executed for JP1/AJS3 - Manager installed on another host.

Return values

| | |
|-----|---|
| 0 | Normal end. |
| 4 | <ul style="list-style-type: none">• An environment variable used for command execution is incorrect.• The JP1/AJS3 service is not running.• The <code>-h</code> option is specified but the specified logical host does not exist or environment settings are incorrect.• The specified execution agent does not exist.• The specified execution agent group does not exist.• The authentication server is not running.• When the <code>-e</code> option was specified, the job distribution delay reduction function was disabled. |
| 8 | An argument specified in the command is incorrect. |
| 12 | Memory became insufficient during command processing. |
| 20 | An attempt to access shared memory failed because the access target was locked. |
| 24 | Permission to execute the command is not granted. |
| 40 | A system limit was exceeded during allocation of shared memory, file descriptors, or resources for exclusive use. |
| 120 | An unexpected error was detected for an OS system call. |
| 124 | An unexpected error was detected in JP1/AJS internal processing. |

Example 1

To output the information for all execution agents and execution agent groups, execute the following command:

```
ajsagtshow -l
```

Example 2

To output the definition information for execution agent AP1, execute the following command:

```
ajsagtshow -a AP1
```

Example 3

To output the status of execution agents, execute the following command:

```
ajsagtshow -e
```

Output example 1

The following shows a sample execution of the command with the `-a` option specified:

Note that, in this example, the job distribution delay reduction function is disabled.

```
ajsagtshow -a AGT01
KNAC1101-I The output of the agent manager information started.
HOSTNAME:HOST01
AGENT   STATUS  HOST      CON-EXE   QUE    JOB  EVENT  DESCRIPTION
-----  -

```

```
AGT01 Ef AGT01 5 0 0 0
KNAC1102-I The output of the agent manager information ended.
```

The following shows the meaning of the output.

HOSTNAME

Indicates a host name.

For a physical host, the local host name is displayed. For a logical host, the name of the logical host is output.

AGENT

Indicates that execution agent names are output in this column.

STATUS

Indicates that the job transfer restriction status of each execution agent is output in this column.

| Value | Status | Description |
|-------|-------------|--|
| Ef | Effective | Jobs are accepted and then delivered to the target host. |
| In | Ineffective | New jobs are not accepted but the jobs that have already been accepted are delivered to the target host. |
| Hd | Hold | Jobs are accepted but are not delivered to the target host. |
| Bl | Blockade | Jobs are neither accepted nor delivered to the target host. |

HOST

Indicates that target host names are output in this column.

CON-EXE

Indicates that the maximum number of jobs that can be executed concurrently is output in this column.

QUE

Indicates that the number of queued jobs (UNIX, PC, flexible, HTTP connection, action, custom, and passing information setting jobs) is output in this column.

JOB

Indicates that the number of running jobs (UNIX, PC, flexible, HTTP connection, action, custom, and passing information setting jobs) is output in this column.

EVENT

Indicates that the number of event jobs and custom event jobs being executed is output in this column.

DESCRIPTION

Indicates that the comment about the execution agent that was specified when the execution agent was added or changed is output in this column.

Output example 2

The following shows a sample execution of the command with the `-g` option specified:

Note that, in this example, the job distribution delay reduction function is disabled.

```
ajsagtshow -g AGTG01
KNAC1101-I The output of the agent manager information started.
HOSTNAME:HOST01
AGENT GROUP STATUS QUE LINKAGENT AGT ST DESCRIPTION
-----
AGTG01 Ef 0 - -
```

```

- AGT01:16 Ef
- AGT02:16 Ef
KNAC1102-I The output of the agent manager information ended.

```

The following shows the meaning of the output.

HOSTNAME

Indicates a host name.

For a physical host, the local host name is displayed. For a logical host, the name of the logical host is output.

AGENT GROUP

Indicates that execution agent group names are output in this column.

STATUS

Indicates that the job transfer restriction status of each execution agent group is output in this column.

| Value | Status | Description |
|-------|-------------|--|
| Ef | Effective | Jobs are accepted and then delivered to the target host. |
| In | Ineffective | New jobs are not accepted but the jobs that have already been accepted are delivered to the target host. |
| Hd | Hold | Jobs are accepted but are not delivered to the target host. |
| B1 | Blockade | Jobs are neither accepted nor delivered to the target host. |

QUE

Indicates that the number of queued jobs (UNIX, PC, flexible, HTTP connection, action, and custom jobs) is output in this column.

LINKAGENT

Indicates that the names and priority levels of each execution agent in the execution agent group are output in this column. A colon (:) is output between the name and priority, with 1 being the lowest priority level and 16 being the highest priority level.

AGT ST

Indicates that the job transfer restriction status of the execution agent is output in this column.

| Value | Status | Description |
|-------|-------------|--|
| Ef | Effective | Jobs are accepted and then delivered to the target host. |
| In | Ineffective | New jobs are not accepted but the jobs that have already been accepted are delivered to the target host. |
| Hd | Hold | Jobs are accepted but are not delivered to the target host. |
| B1 | Blockade | Jobs are neither accepted nor delivered to the target host. |

DESCRIPTION

Indicates that the comment about the execution agent group that was specified when the execution agent group was added or changed is output in this column.

Output example 3

The following shows a sample execution of the command with the `-a` option specified:

The following shows an example when the job distribution delay reduction function is enabled.

```

ajsagtshow -a AGT01
KNAC1101-I The output of the agent manager information started.
HOSTNAME:HOST01
AGENT      STATUS  HOST          CON-EXE  QUE  JOB  EVENT  DESCRIPTION
-----
AGT01      In-Co  AGT01         10       0    5    3  Agent1
KNAC1102-I The output of the agent manager information ended.

```

The following shows the meaning of the output.

HOSTNAME

Indicates a host name.

For a physical host, the local host name is displayed. For a logical host, the name of the logical host is output.

AGENT

Indicates that execution agent names are output in this column.

STATUS

Indicates that the job transfer restriction status for execution agents and the status of execution agents are output in this column.

The following table lists the job transfer restriction status.

| Value | Status | Description |
|-------|-------------|--|
| Ef | Effective | Jobs are accepted and then delivered to the target host. |
| In | Ineffective | New jobs are not accepted but the jobs that have already been accepted are delivered to the target host. |
| Hd | Hold | Jobs are accepted but are not delivered to the target host. |
| Bl | Blockade | Jobs are neither accepted nor delivered to the target host. |

If the job distribution delay reduction function is enabled, the value indicating the job transfer restriction status of an execution agent is followed by the status of the execution agent indicated in *-execution-agent-status* format.

The following table lists the status of execution agent.

| Value | Status | Description |
|-------|---------------|---|
| Nc | Not checked | The status of the execution agent is <i>Not checked</i> . |
| Co | Connectable | The status of the execution agent is <i>Connectable</i> . |
| Uc | Unconnectable | The status of the execution agent is <i>Unconnectable</i> . |
| Ua | Unavailable | The status of the execution agent is <i>Unavailable</i> . |

HOST

Indicates that target host names are output in this column.

CON-EXE

Indicates that the maximum number of concurrently executable jobs is output in this column.

QUE

Indicates that the number of queued jobs (UNIX, PC, flexible, HTTP connection, action, custom, and passing information setting jobs) is output in this column.

JOB

Indicates that the number of running jobs (UNIX, PC, flexible, HTTP connection, action, custom, and passing information setting jobs) is output in this column.

EVENT

Indicates that the number of event jobs and custom event jobs being executed is output in this column.

DESCRIPTION

Indicates that the comment on the execution agent specified when the execution agent was added or changed is output in this column.

Output example 4

The following shows a sample execution of the command with the `-g` option specified:

The following shows an example when the job distribution delay reduction function is enabled.

```
ajsagtshow -g AGTG01
KNAC1101-I The output of the agent manager information started.
HOSTNAME:HOST01
AGENT GROUP      STATUS      QUE LINKAGENT      AGT ST DESCRIPTION
-----
AGTG01           Ef          0 -              -      AgentGroup
                -          - AGT01:1         In-Co  Agent1
                -          - AGT02:2         Bl-Co  Agent2
KNAC1102-I The output of the agent manager information ended.
```

The following shows the meaning of the output.

HOSTNAME

Indicates a host name.

For a physical host, the local host name is displayed. For a logical host, the name of the logical host is output.

AGENT GROUP

Indicates that execution agent group names are output in this column.

STATUS

Indicates the job transfer restriction status of the execution agent group.

| Value | Status | Description |
|-------|-------------|--|
| Ef | Effective | Jobs are accepted and then delivered to the target host. |
| In | Ineffective | New jobs are not accepted but the jobs that have already been accepted are delivered to the target host. |
| Hd | Hold | Jobs are accepted but are not delivered to the target host. |
| Bl | Blockade | Jobs are neither accepted nor delivered to the target host. |

QUE

Indicates that the number of queued jobs (UNIX, PC, flexible, HTTP connection, action, and custom jobs) is output in this column.

LINKAGENT

Indicates that the name and priority of the execution agent in the execution agent group are output in this column. A colon (:) is output between the name and priority. 1 indicates the lowest priority and 16 indicates the highest priority.

AGT ST

Indicates that the job transfer restriction status for execution agents and the status of execution agents are output in this column.

The following table lists the job transfer restriction status.

| Value | Status | Description |
|-------|-------------|--|
| Ef | Effective | Jobs are accepted and then delivered to the target host. |
| In | Ineffective | New jobs are not accepted but the jobs that have already been accepted are delivered to the target host. |
| Hd | Hold | Jobs are accepted but are not delivered to the target host. |
| Bl | Blockade | Jobs are neither accepted nor delivered to the target host. |

If the job distribution delay reduction function is enabled, the value indicating the job transfer restriction status of an execution agent is followed by the status of the execution agent indicated in *-execution-agent-status* format.

The following table lists the status of execution agent.

| Value | Status | Description |
|-------|---------------|---|
| Nc | Not checked | The status of the execution agent is <i>Not checked</i> . |
| Co | Connectable | The status of the execution agent is <i>Connectable</i> . |
| Uc | Unconnectable | The status of the execution agent is <i>Unconnectable</i> . |
| Ua | Unavailable | The status of the execution agent is <i>Unavailable</i> . |

DESCRIPTION

Indicates that the comment on the execution agent group specified when the execution agent group was added or changed is output in this column.

Output example 5

The following shows a sample execution of the command with the *-e* option specified:

```

ajsagtshow -e
KNAC1101-I The output of the agent manager information started.
HOSTNAME:HOST01
AGENT          STATUS  HOST          IP ADDRESS          CHECK TIME
-----
AGT01          Ef-Co   AGT01         -                   2016/01/01 10:00:00
AGT02          Ef-Nc   AGT02         -                   ----/--/-- --:--:--
AGT04          Ef-Uc   AGT04         123.456.789.25     2016/01/01 10:00:10
-              -      -             123.456.987.10     2016/01/01 10:01:40
-              -      -             123.456.797.65     2016/01/01 10:03:10
AGT05          Hd-Ua   AGT05         -                   ----/--/-- --:--:--
AGT06          Ef-Uc   AGT06         123.456.789.27     2016/01/01 10:00:11
KNAC1102-I The output of the agent manager information ended.

```

HOSTNAME

Indicates a host name.

For a physical host, the local host name is displayed. For a logical host, the name of the logical host is output.

AGENT

Indicates that execution agent names are output in this column.

STATUS

Indicates that the job transfer restriction status for execution agents and the status of execution agents are output in this column in *job-transfer-restriction-status-for-exec-agent-execution-agent-status* format.

The following table lists the job transfer restriction status.

| Value | Status | Description |
|-------|-------------|--|
| Ef | Effective | Jobs are accepted and then delivered to the target host. |
| In | Ineffective | New jobs are not accepted but the jobs that have already been accepted are delivered to the target host. |
| Hd | Hold | Jobs are accepted but are not delivered to the target host. |
| Bl | Blockade | Jobs are neither accepted nor delivered to the target host. |

The following table lists the status of execution agent.

| Value | Status | Description |
|-------|---------------|---|
| Nc | Not checked | The status of the execution agent is <i>Not checked</i> . |
| Co | Connectable | The status of the execution agent is <i>Connectable</i> . |
| Uc | Unconnectable | The status of the execution agent is <i>Unconnectable</i> . |
| Ua | Unavailable | The status of the execution agent is <i>Unavailable</i> . |

HOST

Indicates that target host names are output in this column.

IP ADDRESS

Indicates that connection IP addresses are output in this column when the status of the execution agent is *Unconnectable*.

Each IP address that caused a communication error is displayed on one line. A maximum of four IP addresses are displayed (in the order of error occurrence with the most recent shown first).

Communication errors that occurred before IP addresses were resolved are not displayed.

CHECK TIME

The time when the execution agent was checked is displayed in *YYYY/MM/DD hh:mm:ss* format for each IP address.

Note

The **IP ADDRESS** and **CHECK TIME** columns only contain information about the execution agents for which a communication error was detected by the communication status check for the job distribution delay reduction function. To check information about errors detected by any method other than the communication status check, see the error messages output to the integrated trace log.

ajsalter

Format

```
ajsalter
  [-F service-name]
  [-s {none|EXEC}]
  [[-o] -c {CHANGE|COPY}]
```

Description

Temporarily modifies the operating environment for a scheduler service.

Execution privileges

In Windows: Administrators privilege

In UNIX: Superuser privilege

Arguments

-F *service-name*

Specify the name of the target scheduler service.

You can specify a character string of 1 to 30 bytes.

If you omit this option, the system assumes the default scheduler service name.

-s {none|EXEC}

Specify whether you want to suppress the execution of a jobnet or job, or cancel suppression.

If you use this option to suppress execution while a jobnet or job is being executed, the next jobnet or job will not be activated.

- none
Cancels the suppression of execution for a jobnet or job.
- EXEC
Suppresses the execution of a jobnet or job. Once the system has completed the execution of the jobnet or job currently being executed, it will not start any subsequent jobnet or job.

If you use this option, you can temporarily modify the setting of the SUPPRESS environment setting parameter.

-o

If you specify this option, the scheduler log file for the host, not the scheduler service, is replaced.

Depending on whether this option is specified and the value of the AJSLOGOUTPUTDEST environment setting parameter, the scheduler log file to be replaced differs, as described in the following table.

| AJSLOGOUTPUTDEST value | -o option | |
|------------------------|-----------|---------------|
| | Specified | Not specified |
| schedule(default) | H | S |
| host | H | H |

Legend:

- H: The scheduler log file for the host is replaced.
- S: The scheduler log file for the scheduler service is replaced.

You must specify this option with the `-c` option.

-c {CHANGE | COPY}

Specify how to change the scheduler log file.

- CHANGE
Writes history information to the alternate scheduler log file.
- COPY
Copies the contents of the current scheduler log file to the alternate scheduler log file. The system deletes data from the current scheduler log file and then writes history information from the beginning of the file.

If a log output error occurs during output of a scheduler log and the log output is blocked, use this option to replace the scheduler log file. Once the scheduler log file has been replaced, the system cancels blocking of log output.

Notes

- For details about replacement of the scheduler log file, see *7.7 Swapping a scheduler log file in the JPI/Automatic Job Management System 3 Administration Guide*.
- If the `-s` option is specified, the setting of the SUPPRESS environment setting parameter is temporarily modified. The modification is lost the next time the scheduler service is started.

Return values

| | |
|--|--------------|
| 0 | Normal end |
| Multiple of 4 within the range from 4 to 124 | Abnormal end |

Example1

The following command temporarily modifies the jobnet operating environment, suppressing the execution of jobs:

```
ajsalter -s EXEC
```

Example2

To replace the current scheduler log file for the host that contains scheduler service AJSROOT2 with the alternate scheduler log file after copying the contents of the current file to the alternate file, execute the following command:

```
ajsalter -F AJSROOT2 -o -c COPY
```

If `host` is set for the `AJSLOGOUTPUTDEST` environment setting parameter, regardless of whether the `-o` option is specified, scheduler log file for the host is replaced.

```
ajsalter -F AJSROOT2 [-o] -c COPY
```

ajsatmstart (Linux only)

Format

```
ajsatmstart
```

Description

Starts JP1/AJS3 Autonomous Agent Messenger service.

Execution privileges

Superuser privilege

Storage directory

/opt/jp1ajs2/bin/

Arguments

None

Notes

- This command applies only to Linux. You cannot use this command in Windows.
- This command terminates without waiting for completion of the startup of the service. To confirm whether the service has started, execute the `ajsatstatus` command.
- If the port information of the JP1/AJS3 Autonomous Agent Messenger service cannot be read from the `services` file when the JP1/AJS3 Autonomous Agent Messenger service starts, this command terminates abnormally with the KAVS8107-E message.

Return values

| | |
|---------------------|--------------|
| 0 | Normal end |
| Values other than 0 | Abnormal end |

ajsatmstop (Linux only)

Format

```
ajsatmstop
```

Description

Stops JP1/AJS3 Autonomous Agent Messenger service.

Execution privileges

Superuser privilege

Storage directory

/opt/jp1ajs2/bin/

Arguments

None

Notes

- This command applies only to Linux. You cannot use this command in Windows.
- This command terminates when a stop request for the JP1/AJS3 Autonomous Agent Messenger service is sent. Therefore, you cannot use this command to confirm whether the JP1/AJS3 Autonomous Agent Messenger service has stopped. To confirm whether the JP1/AJS3 Autonomous Agent Messenger service has stopped, execute the `ajsatstatus` command.

Return values

| | |
|---------------------|--------------|
| 0 | Normal end |
| Values other than 0 | Abnormal end |

ajsatstart (Linux only)

Format

```
ajsatstart
```

Description

Starts JP1/AJS3 Autonomous Agent service.

Execution privileges

Superuser privilege

Storage directory

/opt/jp1ajs2/bin/

Arguments

None

Notes

- This command applies only to Linux. You cannot use this command in Windows.
- This command terminates without waiting for completion of the startup of the service. To confirm whether the service has started, execute the `ajsatstatus` command.

Return values

| | |
|---------------------|--------------|
| 0 | Normal end |
| Values other than 0 | Abnormal end |

ajsatstatus (Linux only)

Format

```
ajsatstatus
```

Description

Outputs the statuses of the JP1/AJS3 Autonomous Agent service and the JP1/AJS3 Autonomous Agent Messenger service.

Execution privileges

None

Storage directory

/opt/jp1ajs2/bin/

Arguments

None

Note

This command applies only to Linux. You cannot use this command in Windows.

Return values

| | |
|---------------------|--------------|
| 0 | Normal end |
| Values other than 0 | Abnormal end |

Output example

```
JP1/AJS3 Autonomous Agent service           active
JP1/AJS3 Autonomous Agent Messenger service active
```

Description of output items

JP1/AJS3 Autonomous Agent service

Outputs whether the JP1/AJS3 Autonomous Agent service has started.

- active: The JP1/AJS3 Autonomous Agent service has started.
- inactive: The JP1/AJS3 Autonomous Agent service has stopped, or has not been set up.

JP1/AJS3 Autonomous Agent Messenger service

Outputs whether the JP1/AJS3 Autonomous Agent Messenger service has started.

- active: The JP1/AJS3 Autonomous Agent Messenger service has started.
- inactive: The JP1/AJS3 Autonomous Agent Messenger service has stopped, or has not been set up.

ajsatstop (Linux only)

Format

```
ajsatstop
```

Description

Stops JP1/AJS3 Autonomous Agent service.

Execution privileges

Superuser privilege

Storage directory

/opt/jp1ajs2/bin/

Arguments

None

Notes

- This command applies only to Linux. You cannot use this command in Windows.
- This command terminates when a stop request for the JP1/AJS3 Autonomous Agent service is sent. Therefore, this command cannot be used to confirm whether the JP1/AJS3 Autonomous Agent service has stopped. To confirm whether the JP1/AJS3 Autonomous Agent service has stopped, execute the `ajsatstatus` command.

Return values

| | |
|---------------------|--------------|
| 0 | Normal end |
| Values other than 0 | Abnormal end |

ajsbackup

Format

```
ajsbackup
  [-F service-name]
  [-b backup-information-directory-name]
  [-R]
  [-E | -L]
  [-T]
  [{-G | -N | -J}]
  [{-i | -e | -f}]
  [{-m | -a}]
  -n backup-box-name
  unit-name...
```

Description

Converts a *unit* into a backup file and stores it in a backup box.

Executing this command causes a single backup file to be created in the specified backup box. The system names the backup file using the least unused value within the range of 0001 to 1024.

If the `AJSPRINTNETSCHPRF` environment setting parameter specifies the dependency on the schedule for the upper-level jobnet, you can specify either of the following methods to output the unit definition information for the nested jobnet having a schedule rule:

- Enable the schedule rule and do not depend on the schedule for the upper-level jobnet.
- Delete the schedule rule and depend on the schedule for the upper-level jobnet.

For details about how to set the `AJSPRINTNETSCHPRF` environment setting parameter, see [20.4.2\(79\) AJSPRINTNETSCHPRF](#) in the *JP1/Automatic Job Management System 3 Configuration Guide*

Execution privileges

You must have any of the following JP1 privileges:

- JP1_AJS_Admin privilege
- JP1_AJS_Manager privilege
- JP1_AJS_Editor privilege
- JP1_AJS_Operator privilege
- JP1_AJS_Guest privilege

We recommend that the user who executes this command have administrator privileges (in Windows systems) or superuser privileges (in UNIX systems).

Arguments

-F *service-name*

Specify the name of the target scheduler service.

You can specify a character string of 1 to 30 bytes.

-b backup-information-directory-name

Specify the full path of the directory if you use a directory other than the backup information directory[#] specified at the time of configuration.

You can specify a character string of 1 to 255 bytes.

By default, the system assumes the backup information directory[#] specified at the time of configuration.

It refers to the directory name specified by the `AJSBKUROOT` environment setting parameter.

-R

Backs up all *units* in the specified job group or jobnet repeatedly by layers (for details, see [Additional information](#) below).

We recommend that you specify the `-R` option with the `-T` option. In that case, you can collectively back up each layer of units, thus reducing the size of the entire backup information. If you specify the `-R` option with the `-E`, `-L`, `-G`, `-N`, and/or `-J` options, the system backs up *units* according to the specification by each option.

-E

Backs up jobnets and jobs contained in the jobnets registered for execution.

If you specify this option with the `-T`, `-N`, and/or `-J` options, the system backs up *units* according to the specification by each option.

-L

Backs up jobnets and jobs contained in the jobnets not registered for execution.

If you specify this option with the `-T`, `-N`, and/or `-J` options, the system backs up *units* according to the specification by each option. You cannot specify this option with the `-G` option.

-T

Backs up root jobnets or recovery jobnets.

If you specify this option with the `-L` option, the system backs up *units* according to the specification by the `-L` option. You cannot specify this option with the `-G` or `-J` option.

-G

Backs up job groups.

You cannot specify this option with the `-L` or `-T` option.

-N

Backs up jobnets or recovery jobnets.

If you specify this option with the `-L` option, the system backs up *units* according to the specification by the `-L` option.

-J

Backs up jobs, including recovery jobs, QUEUE jobs, recovery QUEUE jobs, OR jobs, event jobs, and custom event jobs.

You cannot specify this option with the `-T` option.

-i

Displays a message with a confirmation prompt if the backup destination contains a *unit* having the same name as a *unit* to be backed up.

-e

Generates an error (without updating information), if the backup destination contains a unit having the same name as a unit to be backed up.

-f

Enforces backup (and updates information) if the backup destination contains a unit having the same name as a unit to be backed up.

-m

Creates a new backup box before backing up units.

The command terminates abnormally if a backup box has already been created.

-a

Adds a backup file to a backup box.

The command terminates abnormally if no backup box has been created.

-n *backup-box-name*

Specify the name of the backup box.

You can specify a character string of 1 to 50 bytes.

The name of the backup box depends on the file system of your operating system. It is case-sensitive if you are using UNIX and case-insensitive if you are using Windows.

unit-name

Specify the name of the unit to be backed up.

You can specify a character string of 1 to 930 bytes.

You can specify one or more units. If you specify the `-R` option with the `-E`, `-L`, `-T`, `-G`, `-N`, and/or `-J` options, the system backs up units according to the specification of each option.

You cannot specify a logical host name or execution ID as a unit name.

Notes

- Either of the following users can back up a unit:
 - A user who has reference privileges for the units to be backed up and the update privilege for the backup box
 - A JP1 user mapped to the OS user who has Administrators or superuser privilegesNote, however, that if `yes` is set after changing the `ADMACLIMIT` environment setting parameter from its default, even a JP1 user who was mapped to an OS user with Administrators or superuser privileges must have the reference privilege for all units and the update privilege for the backup box.

- You can create up to 1,024 backup files in a single backup box. You cannot create 1,025 or more backup files.
- If the command is executed for a release target jobnet (root jobnet for which release entry is made), the jobnet definitions in *Being applied* status are backed up. However, the unit definition information to be backed up does not include the release information.

Return values

| | |
|--|--------------|
| 0 | Normal end |
| Multiple of 4 within the range from 4 to 124 | Abnormal end |

Additional information

The following describes an example for backing up units repeatedly by layers:

Example:

If you specify the `-R` option to back up a job group (`group1`) having the following structure, the system backs up elements of layers (A) to (H) in separate backup files.

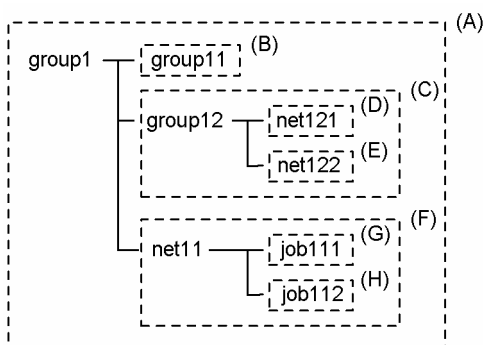

Example

The following command backs up all units contained in job group `/Materials/ShipManagement` to a newly created backup box, `BOX1`:

```
ajsbackup -RTmn BOX1 /Materials/ShipManagement
```

ajsbkudel

Format

```
ajsbkudel
  [-F service-name]
  [-b backup-information-directory-name]
  [-i]
  -n backup-box-name
  [backup-file-name...]
```

Description

Deletes a backup box or backup file.

Execution privileges

OS execution privileges for the backup files and directories to be deleted

Arguments

-F *service-name*

Specify the name of the target scheduler service.

You can specify a character string of 1 to 30 bytes.

If you omit this option, the system assumes the default scheduler service name.

-b *backup-information-directory-name*

Specify the full path of the directory if you use a directory other than the backup information directory[#] specified at the time of configuration.

You can specify a character string of 1 to 255 bytes.

By default, the system assumes the backup information directory[#] specified at the time of configuration.

#

This term refers to the directory name specified by the `AJSBKUROOT` environment setting parameter.

-i

Displays a message with a confirmation prompt before deleting a backup box or file.

-n *backup-box-name*

Specify the name of the backup box to be deleted.

You can specify a character string of 1 to 50 bytes.

The name of the backup box depends on the file system of your operating system. It is case-sensitive if you are using UNIX and case-insensitive if you are using Windows.

backup-file-name

Specify the name of the backup file to be deleted, following the name of the backup box containing it.

Specify a value ranging from 0001 to 1024. You can specify one or more backup files. To specify more than one file, separate them by at least one space character.

Notes

- To delete a backup box or backup file, you must have the update privilege for both the backup box and backup file.
- If you delete a backup box, the directory having the backup box name within the backup information directory is not deleted. After the `ajsbkudel` command deletes the backup box, use the `rmdir` command as required to delete the directory having the backup box name.

Return values

| | |
|--|--------------|
| 0 | Normal end |
| Multiple of 4 within the range from 4 to 124 | Abnormal end |

Example

The following command deletes backup file 0001 from backup box BOX1:

```
ajsbkudel -n BOX1 0001
```

ajscalendar

Format

```
ajscalendar
  [-F service-name]
  [-lt {hour:minute|none|no}]
  [-ld {day|none|no|{sun|su|mon|mo|tue|
    tu|wed|we|thu|th|fri|fr|sat|sa}:n}]
  [-md {this|th|next|ne|none|no}]
  [-c]
  [-op {sun|su|mon|mo|tue|tu|wed|we|
    thu|th|fri|fr|sat|sa|
    {year/month/day|
    {sun|su|mon|mo|tue|tu|wed|we|
    thu|th|fri|fr|sat|sa}[:n]}}}]
  [-cl {sun|su|mon|mo|tue|tu|wed|we|
    thu|th|fri|fr|sat|sa|
    {year/month/day|
    {sun|su|mon|mo|tue|tu|wed|we|
    thu|th|fri|fr|sat|sa}[:n]}}}]
  [-no {sun|su|mon|mo|tue|tu|wed|we|
    thu|th|fri|fr|sat|sa|{year/month/day|
    {sun|su|mon|mo|tue|
    tu|wed|we|thu|th|fri|fr|sat|sa}
    [:n]}}}]
  [-of open-day-information-file-name]
  [-cf closed-day-information-file-name]
  [-nf canceled-day-information-file-name]
  [-df calendar-information-file-name]
  [-d year/month/day]
  [-R]
  job-group-name...
```

Description

Defines calendar information for a job group.

Execution privileges

You must have any of the following JP1 privileges:

- JP1_AJS_Admin privilege
- JP1_AJS_Manager privilege
- JP1_AJS_Editor privilege

Arguments

-F *service-name*

Specify the name of the target scheduler service.

You can specify a character string of 1 to 30 bytes.

-lt {hour:minute|none|no}

Set the base time for the calendar.

- *hour:minute*

You can specify a value between 0 and 23 for the hour.

You can specify a value between 0 and 59 for the minute.

- *none|no*

Inherits the base time in the calendar information defined for an upper-level job group.

If calendar information is defined for none of the upper-level job groups, the system assumes 0:00.

-ld {day|none|no|{sun|su|mon|mo|tue|tu|wed|we|thu|th|fri|fr|sat|sa}:n}

Set the base date for the calendar.

- *day*

You can specify a value between 1 and 31 for the day.

- *none|no*

Inherits the base date in the calendar information defined for an upper-level job group.

If calendar information is defined for none of the upper-level job groups, the system assumes the first day of the month.

- *sun|su*

Sets the base date to Sunday.

- *mon|mo*

Sets the base date to Monday.

- *tue|tu*

Sets the base date to Tuesday.

- *wed|we*

Sets the base date to Wednesday.

- *thu|th*

Sets the base date to Thursday.

- *fri|fr*

Sets the base date to Friday.

- *sat|sa*

Sets the base date to Saturday.

- *n*

Specify the week for the day; a value between 1 and 5 (specifying 1 for Sunday, for example, indicates the first Sunday of the month).

You must specify this value when specifying the day of the week, such as *sun* or *su*.

-md {this|th|next|ne|none|no}

Specify the base month for the calendar (specify the month to which a date belongs relative to the base date).

- *this|th*

Sets dates following the base date to be those of the month to which the base date belongs.

- `next|ne`

Sets dates following the base date to be those of the month next to the month to which the base date belongs.

- `none|no`

Inherits the base month in the calendar information defined for an upper-level job group.

If calendar information is defined for none of the upper-level job groups, the system assumes the base date's month.

-c

Deletes calendar information.

If you delete calendar information, the system inherits the calendar information defined for an upper-level job group.

You cannot use this option to delete the base time, base date, and base month. To delete these settings, specify `none` for the corresponding option.

If you specify this option with any of the `-op`, `-cl`, `-no`, `-of`, `-cf`, `-nf`, and `-df` options, the system deletes calendar information before setting the open, closed, or canceled day, regardless of the sequence in which you specify the options.

-op {`sun|su|mon|mo|tue|tu|wed|we|thu|th|fri|fr|sat|sa` | {`year/month/day` | {`sun|su|mon|mo|tue|tu|wed|we|thu|th|fri|fr|sat|sa`}[: *n*]}}

Specify an open day (a day on which you will execute a jobnet).

You can specify one or more open days.

For details about the date format, see *Additional information* below.

-cl {`sun|su|mon|mo|tue|tu|wed|we|thu|th|fri|fr|sat|sa` | {`year/month/day` | {`sun|su|mon|mo|tue|tu|wed|we|thu|th|fri|fr|sat|sa`}[: *n*]}}

Specify a closed day (a day on which you will not execute a jobnet).

You can specify one or more closed days.

For details about the date format, see *Additional information* below.

-no {`sun|su|mon|mo|tue|tu|wed|we|thu|th|fri|fr|sat|sa` | {`year/month/day` | {`sun|su|mon|mo|tue|tu|wed|we|thu|th|fri|fr|sat|sa`}[: *n*]}}

Specify a canceled day (a day on which you will cancel the specification of an open or closed day).

You can specify one or more canceled days.

For details about the date format, see *Additional information* below.

-of **open-day-information-file-name**

Specify the name of the file containing the dates of open days (for details about the date format, see *Additional information* below).

You can specify a character string of 1 to 255 bytes.

The system adds open days to the calendar information according to the contents of this file.

-cf closed-day-information-file-name

Specify the name of the file containing the dates of closed days (for details about the date format, see *Additional information* below).

You can specify a character string of 1 to 255 bytes.

The system adds closed days to the calendar information according to the contents of this file.

-nf canceled-day-information-file-name

Specify the name of the file containing the dates of canceled days (for details about the date format, see *Additional information* below).

You can specify a character string of 1 to 255 bytes.

The system adds canceled days to the calendar information according to the contents of this file.

-df calendar-information-file-name

Specify the name of the calendar information file, in which calendar information parameters, indicating open and closed days, are defined.

For the calendar information file in this option, you can specify a file obtained by executing the following:

- The `ajsprint` command with the `-d` option specified.
- The `ajscalutil` command.

You can specify a character string of 1 to 255 bytes.

If you specify `stdin` as the file name, the system inputs calendar information from the standard input.

Only the parameters indicating open and closed days can be specified in a calendar information file as unit definition parameters. You cannot specify the base time, base date, or base month. For details about unit definition parameters, see *5.1 Creating a unit definition file*.

-d year/month/day

Deletes the calendar information previous to the specified date (for example, specifying `-d 2006/6/1` deletes the calendar information previous to June 1, 2006, including the information for June 1, 2006).

- *year*
You can specify a value between 1994 and the value of the `SCHEDULELIMIT` environment setting parameter for the year. For details about the `SCHEDULELIMIT` environment setting parameter, see *20.4.2(123) SCHEDULELIMIT* in the *JP1/Automatic Job Management System 3 Configuration Guide*.
- *month*
You can specify value between 1 and 12 for the month.
- *day*
You can specify a value between 1 and 31 for the day.

-R

Defines calendar information for all job groups contained in the specified job group.

job-group-name

Specify the name of the job group for which you want to define calendar information.

You can specify a character string of 1 to 930 bytes.

You can specify one or more job groups.

You cannot specify a logical host name or execution ID as a job group name.

Notes

- Either of the following users can define calendar information:
 - A user granted the update privilege when a job group was defined or when its attributes were changed. If the job group has higher job groups, the user must have the reference privilege for all of the groups.
 - A JP1 user mapped to the OS user who has Administrators or superuser privileges
Note, however, that if `yes` is set after changing the `ADMACLIMIT` environment setting parameter from its default, even a JP1 user who was mapped to an OS user who has Administrators or superuser privileges must have the reference privilege and the update privilege.
- If an open day information file, closed day information file, canceled day information file, or calendar definition file contains calendar information which does not conform to the specified format, the `ajscalendar` command ignores that information and continues processing. Make sure that a line feed is specified at the end of the information file. If there is no line feed, the last line will be treated as external format information and ignored. In addition, the calendar information specified on the last line will not be defined even if the `ajscalendar` command has been successfully executed.
- If you simultaneously specify an open day information file, closed day information file, canceled day information file, and calendar definition file, any error encountered during the processing of one of the files causes the `ajscalendar` command to stop processing for the erroneous file and continue processing for other files.
Note that the `ajscalendar` command defines only the calendar information in successfully processed files, and then abnormally terminates.
- If nothing is defined in the open day information file, closed day information file, canceled day information file, or calendar definition file, the system does not modify the corresponding calendar information.
- If you modify the calendar information for a job group simultaneously with `ajscalendar` command and the Edit Monthly Calendar or Edit Annual Calendar window of JP1/AJS3 - View, the results will be unpredictable.
- Always separate an option and its value by at least one space character.
- For `ajscalendar` command, you cannot specify more than one option.
Correct use: `ajscalendar -c -F AJSROOT1 /GROUP`
Incorrect use: `ajscalendar -cF AJSROOT1 /GROUP`
- If the open day information file, closed day information file, canceled day information file, or calendar definition file contains no valid calendar information, and if no valid calendar definition option is specified, `ajscalendar` command ends abnormally.
- If any invalid calendar definition option is specified, the command ends abnormally.
- Make sure that the `ajscalendar` command is executed when the amount of processing is small. Execution of the command might affect operation because execution of root jobnets registered in the same scheduler service as the job group for which calendar information is defined is suppressed. However, a jobnet with start conditions placed in *Now monitoring* status before the definition is changed is executed when the start conditions are satisfied during execution of the `ajscalendar` command.

- If calendar information for the current day is changed from closed day to open day, the schedule is recalculated. As a result, the current day's execution schedule might be created for a jobnet registered for planned execution, and then jobs might be executed according to this execution schedule.

Return values

| | |
|--|--------------|
| 0 | Normal end |
| Multiple of 4 within the range from 4 to 124 | Abnormal end |

Additional information

- The schedule is recalculated if the following conditions are satisfied:
 - A scheduler service of the specified job group is running.
 - This command has terminated normally.
- The following shows the formats of a standard-week value and open, closed, and canceled days, which are calendar information stored in open day information, closed day information, and canceled day information files. The three types of information files use the same format. Make sure that a line feed is specified at the end of the information file. If there is no line feed, the last line will be treated as external format information and ignored. In addition, the calendar information specified on the last line will not be defined even if the `ajscalendar` command has been successfully executed.

Format of standard-week values:

sun|su: Specifies Sunday.
 mon|mo: Specifies Monday.
 tue|tu: Specifies Tuesday.
 wed|we: Specifies Wednesday.
 thu|th: Specifies Thursday.
 fri|fr: Specifies Friday.
 sat|sa: Specifies Saturday.

Format of open, closed, and canceled days:

`YYYY/MM/{DD{sun|su|mon|mo|tue|tu|wed|we|thu|th|fri|fr|sat|sa}[:n]}`

- *YYYY*
 You can specify a value between 1994 and the value of the `SCHEDULELIMIT` environment setting parameter for the year. For details about the `SCHEDULELIMIT` environment setting parameter, see *20.4.2(123) SCHEDULELIMIT* in the *JP1/Automatic Job Management System 3 Configuration Guide*.
- *MM*
 You can specify value between 1 and 12 for the month.
- *DD*
 You can specify a value between 1 and 31 for the day.
- *n*
 Specify the week for the day; a value between 1 and 5 (specifying 1 for Sunday, for example, indicates the first Sunday of the month).
 If you specify 5 for a month which does not have the fifth week, the system invalidates the calendar information.
- Calendar information options (`-op`, `-cl`, and `-no`) specified later take precedence over those specified earlier (for example, if you specify `-op mon -cl mon -no mon`, the system places a higher priority on `-no mon`, thus handling Monday as a canceled day).

- If you specify a standard-week value and open, closed, and canceled days simultaneously, the open, closed, and canceled days take precedence (for example, if you specify `-op 2010/10/25 -cl sun`, the system places a higher priority on `-op 2010/10/25`, thus handling October 25, 2010 as an open day).
- If you specify the day of the week for an open, closed, or canceled day, the day is converted to the corresponding date and then stored as calendar information.
- If you do not set calendar information for a job group, JP1/AJS3 references the calendar information of the upper-level job group or the scheduler service. If calendar information is not set for the upper-level job group and the scheduler service, open days are assumed.

Example 1

The following command deletes the calendar information for job group `/Sales`, and then sets the closed days for October 2010 (Saturdays and Sundays). This example assumes that the closed days are defined in the closed day information file (`/tmp/calendar`).

```
ajscalendar -c -cf /tmp/calendar /Sales
```

Contents of the closed day information file (`/tmp/calendar`)

```
2010/10/sat
2010/10/sun
```

Example 2

The following command sets the calendar information for job group `/Sales`. (Saturdays and Sundays are set to closed days according to the standard-week values. In October 2010, however, Saturdays are assumed to be open days.)

```
ajscalendar -cl su -cl sa -op 2010/10/sa /Sales
```

ajscalutil

Format

```
ajscalutil
  [-F scheduler-service-name]
  -b year/month[/day] -e year/month[/day]
  [-o|-a|-x|-v]
  -s {db|da|be|af},shifted-open-days[,maximum-shiftable-open-days] |
  -t {be|af}[,maximum-shiftable-closed-days] ]
  [-cg job-group-name | -cf calendar-information-file-name]
  [-Xg job-group-name | -Xf calendar-information-file-name]
  {-g job-group-name | -f calendar-information-file-name}...
```

Format1 (merging open days with OR condition)

```
ajscalutil
  [-F scheduler-service-name]
  -b year/month[/day] -e year/month[/day]
  [-o] {-g job-group-name | -f calendar-information-file-name}...
```

Format2 (merging open days with AND condition)

```
ajscalutil
  [-F scheduler-service-name]
  -b year/month[/day] -e year/month[/day]
  -a {-g job-group-name | -f calendar-information-file-name}...
```

Format3 (excluding open days)

```
ajscalutil
  [-F scheduler-service-name]
  -b year/month[/day] -e year/month[/day]
  -x
  {-g job-group-name | -f calendar-information-file-name}...
  {-Xg job-group-name | -Xf calendar-information-file-name}
```

Format4 (reversing open days and closed days)

```
ajscalutil
  [-F scheduler-service-name]
  -b year/month[/day] -e year/month[/day]
  -v
  {-g job-group-name | -f calendar-information-file-name}...
```

Format5 (shifting open days)

```
ajscalutil
  [-F scheduler-service-name]
  -b year/month[/day] -e year/month[/day]
  -s {db|da|be|af},shifted-open-days[,maximum-shiftable-open-days] |
  [-cg job-group-name | -cf calendar-information-file-name]
  {-g job-group-name | -f calendar-information-file-name}...
```

Format6 (substituting the schedule for closed days)

```
ajscalutil
  [-F scheduler-service-name]
  -b year/month[/day] -e year/month[/day]
  -t {be|af}[,maximum-shiftable-closed-days]
  [-cg job-group-name | -cf calendar-information-file-name]
  {-g job-group-name | -f calendar-information-file-name}...
```

Format7 (extracting a period of calendar information)

```
ajscalutil
  [-F scheduler-service-name]
  -b year/month[/day] -e year/month[/day]
  {-g job-group-name | -f calendar-information-file-name}...
```

Description

The `ajscalutil` command calculates multiple sets of calendar information (this is called *calendar calculation*), and then outputs the results to the standard output file in the format of the calendar information file. You can define combined sets of calendar information for a job group by specifying the output results in the `-df` option of the `ajscalendar` command. For details on the `ajscalendar` command, see [ajscalendar in 3. Commands Used for Normal Operations](#). You can also combine the results of multiple calendar calculations by specifying the output results in the `-cf`, `-xf`, and `-f` options of the `ajscalutil` command.

Note that the output information indicates the unit definition parameters for open days and closed days. For details about the format of unit definition parameters that can be specified for the `ajscalutil` command, see the [Notes](#).

Execution privileges

If a job group name is specified:

This command can be executed by a user at the following JP1 permission level:

- JP1_AJS_Admin
- JP1_AJS_Manager
- JP1_AJS_Editor
- JP1_AJS_Operator
- JP1_AJS_Guest

If a job group name is not specified:

None

Arguments

-F scheduler-service-name

Specify the name of the target scheduler service.

You can specify a character string of 1 to 30 bytes.

-b year/month[/day]

Specify the start date of the period for which calendar information is output. You cannot omit this option.

- *year*

You can specify a value between 1994 and 2099 for the year.

- *month*

You can specify a value between 1 (or 01) and 12.

- *day*

You can specify a value between 1 (or 01) and 31. If you omit this option, the system assumes 1.

-e *year/month [/day]*

Specify the end date of the period for which calendar information is output. You cannot omit this option.

- *year*

You can specify a value between 1994 and 2099 for the year.

- *month*

You can specify a value between 1 (or 01) and 12.

- *day*

You can specify a value between 1 (or 01) and 31. If you omit this option, the system assumes the last date of the year and month specified for *year* and *month*.

-o

Merges the open days in the calendar information specified by the *-g* and *-f* options by using the OR condition.

If you specify this option, you can specify a maximum of eight sets of *-g* and *-f* options.

You cannot specify this option with the *-a*, *-x*, *-v*, *-s*, *-t*, *-cg*, *-cf*, *-Xg*, or *-Xf* option.

If none of the *-o*, *-a*, *-x*, *-v*, *-s*, and *-t* options is specified, the *ajscalutil* command assumes the *-o* option.

-a

Merges the open days in the calendar information specified by the *-g* and *-f* options by using the AND condition.

If you specify this option, you can specify a maximum of eight sets of *-g* and *-f* options.

You cannot specify this option with the *-o*, *-x*, *-v*, *-s*, *-t*, *-cg*, *-cf*, *-Xg*, or *-Xf* option.

-x

Applies the open days in the calendar information specified by the *-Xg* and *-Xf* options as closed days to the calendar information specified by the *-g* or *-f* option.

If you specify this option, you can specify either the *-g* or *-f* option only once.

You cannot specify this option with the *-o*, *-a*, *-v*, *-s*, *-t*, *-cg* or *-cf* option.

-v

Reverses the open days and closed days in the calendar information specified by the *-g* or *-f* option.

If you specify this option, you can specify either the *-g* or *-f* option only once.

You cannot specify this option with the *-o*, *-a*, *-x*, *-s*, *-t*, *-cg*, *-cf*, *-Xg*, or *-Xf* option.

-s {db|da|be|af} , *shifted-open-days* [, *maximum-shiftable-open-days*]

Specify open day shifting conditions.

Open days (shift target) in the calendar information specified by the `-g` and `-f` options are shifted forward or backward according to the specified conditions.

- `db`
Open days are shifted forward by the specified number of shifted open days.
- `da`
Open days are shifted backward by the specified number of shifted open days.
- `be`
Open days are shifted forward by the number of shifted open days in the calendar information specified by the `cg` and `cf` options.
- `af`
Open days are shifted backward by the number of shifted open days in the calendar information specified by the `cg` and `cf` options.
- *shifted-open-days*
Specify the number of days to be shifted. You can specify a value between 1 (or 01) and 31.
- *maximum-shiftable-open-days*
Specify the period as the number of days by which to shift the date. You can specify a value between 1 (or 01) and 31. If you omit this option, the system assumes 31.

If `be` or `af` is specified and an open day after the shift falls outside the period specified by *maximum-shiftable-open-days*, the shift-target open day will be a closed day. The concept of shifting is the same as *schedule by days from start* in the schedule rules. For details, see 3.3.2(1)(g) *Schedule by days from start* in the manual *JP1/Automatic Job Management System 3 Overview*. Note that the value specified for *shifted-open-days* must be equal to or smaller than the value of *maximum-shiftable-open-days*.

If you specify `db` or `da`, the `cg` and `cf` options and *maximum-shiftable-open-days* are ignored if they are specified.

If you specify `be` or `af`, you need to specify the `cg` or `cf` option.

If you specify this option, you can specify either the `-g` option or the `-f` option only once.

You cannot specify this option with the `-o`, `-a`, `-x`, `-v`, `-t`, `-Xg` or `-Xf` option.

-t {be|af} [, *maximum-shiftable-closed-days*]

Specify the conditions for the substitute schedule for closed days.

As the target of the substitute schedule, open days in the calendar information specified by the `-g` and `-f` options are compared with closed days in the calendar information specified by the `cg` and `cf` options. If an open day falls on a closed day in the comparison-target calendar, the nearest open day before or after that closed day is used as the substitute date.

- `be`
The closed day is shifted to the nearest open day before the closed day.
- `af`
The closed day is shifted to the nearest open day after the closed day.

- *maximum-shiftable-closed-days*

Specify the period (number of days) within which a substitute date can be determined. You can specify a value between 1 (or 01) and 31. If you omit this option, the system assumes 31.

If the substitute open day falls outside the period specified by *maximum-shiftable-closed-days*, that open day will be a closed day. For details about the concept of substitute schedule for closed days, see 3.3.2(1)(c) *Substitute schedule of closed day job* in the manual *JP1/Automatic Job Management System 3 Overview*.

If you specify this option, you need to specify the `-cg` or `-cf` option.

If you specify this option, you can specify either the `-g` option or the `-f` option only once.

You cannot specify this option with the `-o`, `-a`, `-x`, `-v`, `-s`, `-Xg` or `-Xf` option.

`-cg` *job-group-name*

Specify the name of the job group for which comparison-target calendar information is defined for shifting open days or a substitute schedule for closed days.

You can specify a character string of 1 to 930 bytes.

You must specify this option with the `-s` and `-t` option.

You cannot specify a scheduler service name, logical host name, execution ID, or wildcard characters for a job group name.

`-cf` *calendar-information-file-name*

Specify the calendar information file that defines comparison-target calendar information for shifting open days or a substitute schedule for closed days. By specifying the calendar information file output by the `ajscalutil` command, you can combine multiple calculation results.

You can specify a character string of 1 to 255 bytes.

If you specify `stdin` as the file name, calendar information will be input from the standard input.

You must specify this option with the `-s` and `-t` option.

`-xg` *job-group-name*

Specify the name of the job group for which calendar information used for excluding open days is defined.

You can specify a character string of 1 to 930 bytes.

You must specify this option with the `-x` option.

You cannot specify a scheduler service name, logical host name, execution ID, or wildcard characters for a job group name.

`-xf` *calendar-information-file-name*

Specify the calendar information file that defines calendar information used for excluding open days. By specifying the calendar information file output by the `ajscalutil` command, you can combine multiple calculation results.

You can specify a character string of 1 to 255 bytes.

If you specify `stdin` as the calendar information file name, the system inputs calendar information from the standard input.

You must specify this option with the `-x` option.

-g *job-group-name*

Specify the name of the job group for which calendar information used as the base for calendar calculation is defined.

You can specify a character string of 1 to 930 bytes.

If you specify the `-o` or `-a` option, you can specify a maximum of eight sets of `-g` and `-f` options.

You cannot specify a scheduler service name, logical host name, execution ID, or wildcard characters for a job group name.

-f *calendar-information-file-name*

Specify the calendar information file that defines calendar information used as the base for calendar calculations. By specifying the calendar information file output by the `ajscalutil` command, you can combine multiple calculation results.

You can specify a character string of 1 to 255 bytes.

If you specify `stdin` as the file name, calendar information will be input from the standard input.

If you specify the `-o` or `-a` option, you can specify a maximum of eight sets of `-g` and `-f` options.

Notes

- If you specify the `-s` or `-t` option, calendar calculations use calendar information for the number of days specified in *shifted-open-days*, *maximum-shiftable-open-days*, and *maximum-shiftable-closed-days*, before and after the period specified by the `-b` and `-e` options. When you specify the `-s` or `-t` option, specify a sufficient period for the base calendar information used for calendar calculations.

Output conditions

- Shift to the next open day.
- Maximum shiftable days: 31
- Output period: May 2016

Specified options

```
-b 2016/5/1 -e 2016/5/31
-t af,31
```

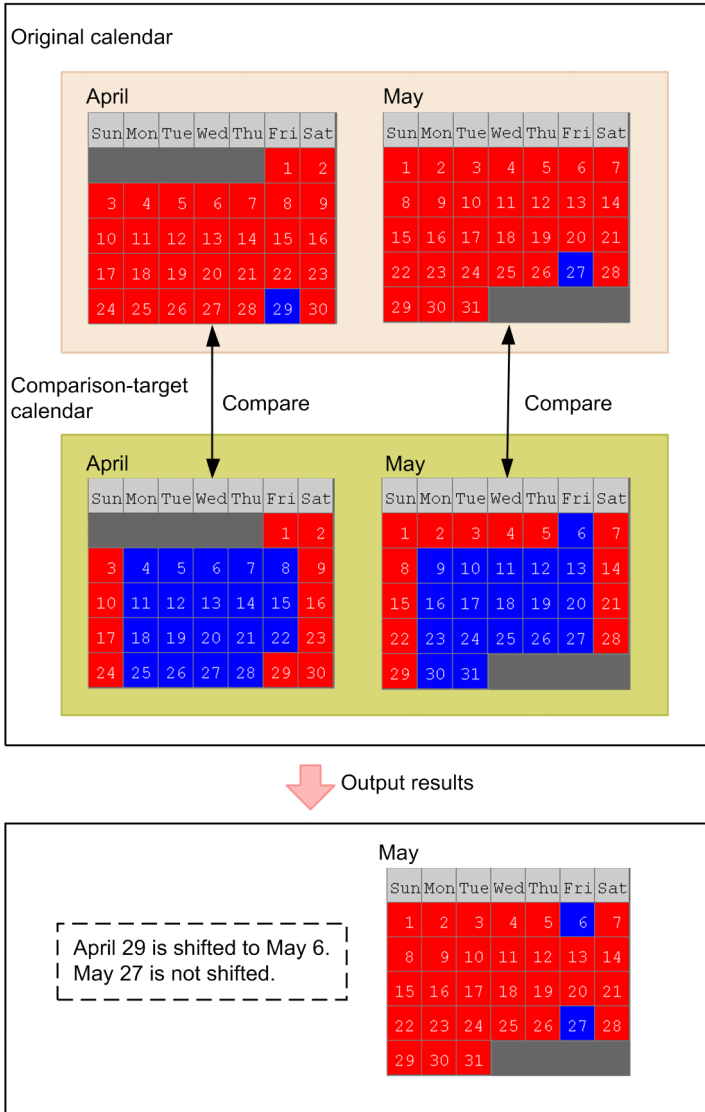

Because *maximum-shiftable-closed-days* is set to 31 in this figure, the months before and after May (output period) are also subject to calendar calculations, in addition to May.

Therefore, if you want to execute this command divided into several operations, specify the period based on the consideration of shifting and substitute schedule for closed days. Then, if necessary, extract calendar information for the period to be used.

- For the `-cf`, `-Xf`, and `-f` options, you can specify `stdin` as the calendar information file name only once in a single execution of the command.
- If you specify the same date for unit definition parameters that can be specified in the calendar information file that is specified for the `-cf`, `-Xf`, or `-f` option, the definition specified last takes effect.

- You can specify unit definition parameters in the calendar information file specified for the `-cf`, `-Xf`, and `-f` options. At this time, specify the parameter indicating a specific open day (`op=yyyy/mm/dd;`) or the parameter indicating a specific closed day (`cl=yyyy/mm/dd;`).
 - `yyyy`: You can specify a value between 1994 and 2099 for the year.
 - `mm`: You can specify a value between 1 (or 01) and 12 for the month.
 - `dd`: You can specify a value between 1 (or 01) and 31 for the day of the month.
- Specify no more than one unit definition parameter per line. If the calendar information file includes invalid characters such as halfwidth spaces or tab characters, or a unit definition parameter is specified in an invalid format, the `ajscalutil` command will ignore the applicable line as an invalid unit definition parameter, output the KAVS0603-E message, and continue processing.
- Separate each line of the calendar information file by using a line break.

Example

```
op=2016/05/01;<line break>
cl=2016/05/02;<line break>
:
cl=2016/05/30;<line break>
op=2016/05/31;<line break>
```

Excluding the last line, if the calendar information file includes other lines that consist of only a line break, the system will ignore that line as an invalid unit definition parameter, output the KAVS0603-E message, and continue processing.

When the KAVS0603-E message is output for a line that contains only a line break, the message will not include a character string for *option-character-string*.

- If the calendar information file specified by using the `-cf`, `-Xf`, or `-f` option includes an invalid unit definition parameter, the system will ignore the applicable line as an invalid unit definition parameter, output the KAVS0602-E or KAVS0603-E message, and continue processing. If a file specified for the `-cf`, `-Xf`, or `-f` option is a file that does not contain calendar information, such as a 0-byte file or a file without a valid unit definition parameter, the command terminates abnormally without calculating calendar information.
- If a job group name is specified, either of the following users can output calendar information.
 - A user who have reference privileges for all job groups that are to be included in calendar information calculations. If the job group has higher job groups, the user must have the reference privilege for all of the groups.
 - A JP1 user mapped to the OS user who has Administrators or superuser privileges.

Note, however, that If `yes` is set after changing the `ADMACLIMIT` environment setting parameter from its default, even a JP1 user who was mapped to an OS user who has Administrators or superuser privileges must have the reference privilege and the update privilege.

Return values

| | |
|--|--------------|
| 0 | Normal end |
| Multiple of 4 within the range from 4 to 124 | Abnormal end |

Additional information

- If you specify the `-cg`, `-Xg`, or `-g` option, the command merges calendar information for the specified job group and calendar information for all higher-level job groups, and then performs a calendar calculation. As a result of the merge, dates that are not defined as open days or closed days are handled as open days.

- In the calendar information file specified for the `-cf`, `-Xf`, or `-f` option, dates that are not specified as open days or closed days are handled as open days.

Example 1

The following command combines the calendar information for multiple job groups (`/CAL/ApplicationA` and `/CAL/ApplicationB`) with the OR condition, and then outputs the results to the standard output file:

```
ajscalutil -b 2016/4 -e 2017/3 -o -g /CAL/ApplicationA -g /CAL/ApplicationB
```

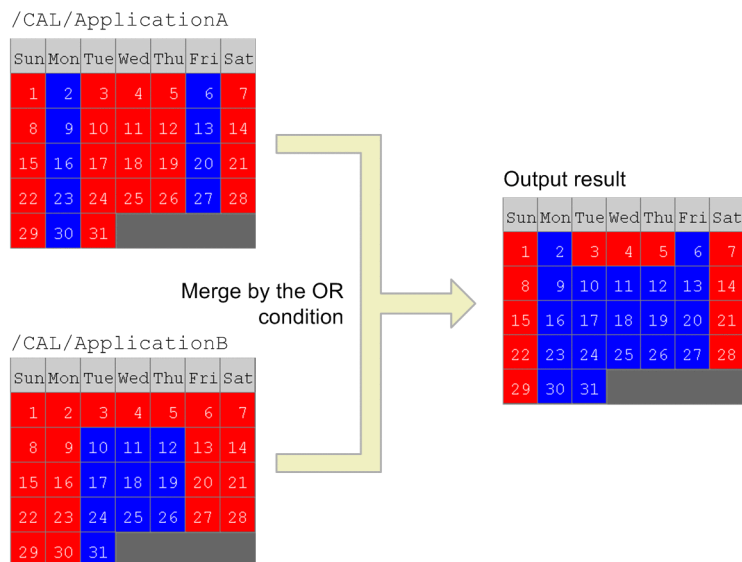

Example 2

The following command combines the calendar information for multiple job groups (`/CAL/ApplicationC` and `/CAL/ApplicationD`) with the AND condition, and then outputs the results to the standard output file:

```
ajscalutil -b 2016/4 -e 2017/3 -a -g /CAL/ApplicationC -g /CAL/ApplicationD
```

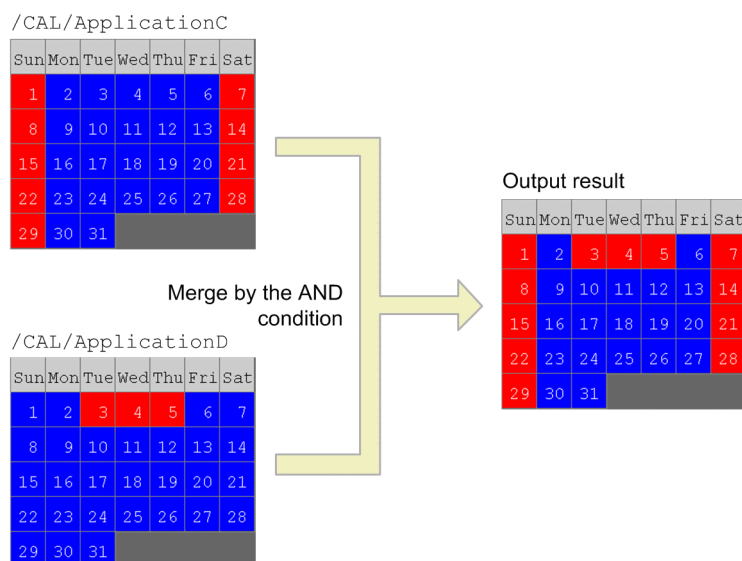

Example 3

The following command applies the open days for job group /CAL/ApplicationE to the calendar information for job group /CAL/ApplicationC as closed days, and then outputs the result to the standard output file:

```
ajscalutil -b 2016/5 -e 2016/5 -x -g /CAL/ApplicationC -Xg /CAL/ApplicationE
```

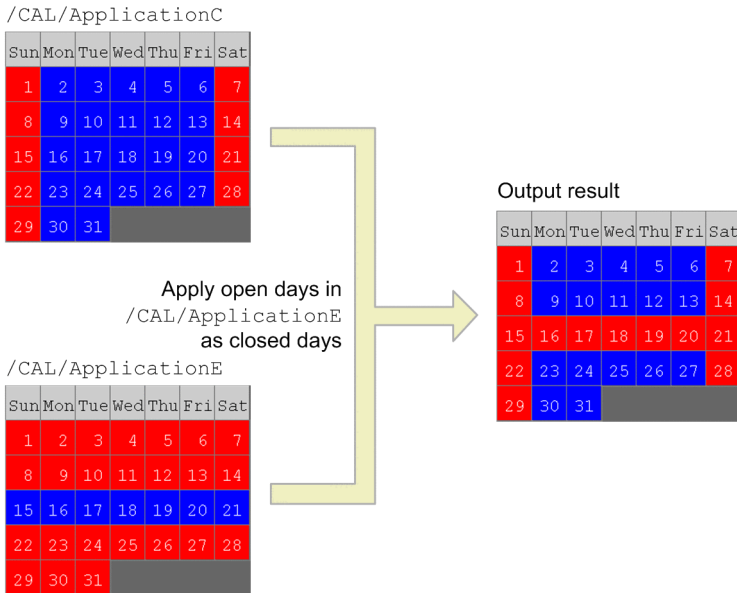

Example 4

The following command reverses the open days and closed days for job group /CAL/ApplicationA, and then outputs the result to the standard output file:

```
ajscalutil -b 2016/5 -e 2016/5 -v -g /CAL/ApplicationA
```

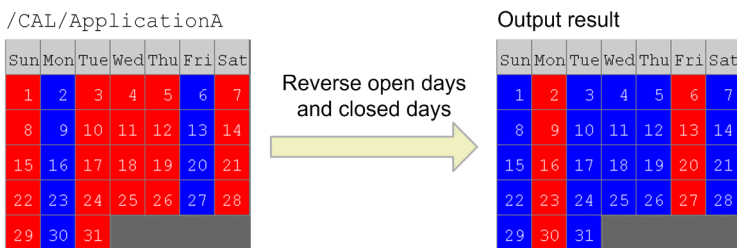

Example 5

The following command shifts the calendar information for /CAL/ApplicationA back by one day, and then outputs the result to the standard output file:

```
ajscalutil -b 2016/5 -e 2016/5 -s db,1 -g /CAL/ApplicationA
```

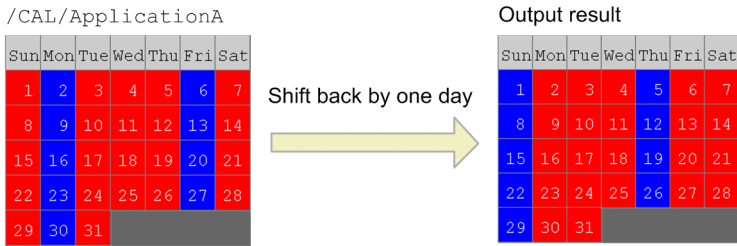

Example 6

The command below compares the calendar information for job group /CAL/ApplicationF with that for job group /CAL/ApplicationG. The command then shifts the calendar information for /CAL/ApplicationF forward by two open days in the calendar information for /CAL/ApplicationG, and then outputs the result to the standard output file.

```
ajscalutil -b 2016/5 -e 2016/5 -s af,2 -cg /CAL/ApplicationG -g /CAL/Applica
tionF
```

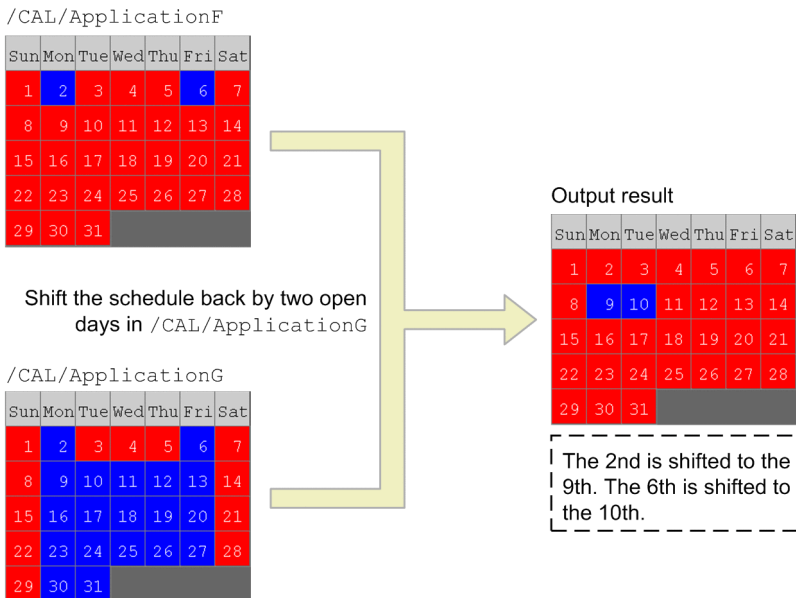

Example 7

The command below compares the calendar information for job group /CAL/ApplicationH with that for job group /CAL/ApplicationG. Then, the command shifts the execution days to the next open days, and then outputs the result to the standard output file.

```
ajscalutil -b 2016/5 -e 2016/5 -t af -cg /CAL/ApplicationH -g /CAL/Applicati
onG
```

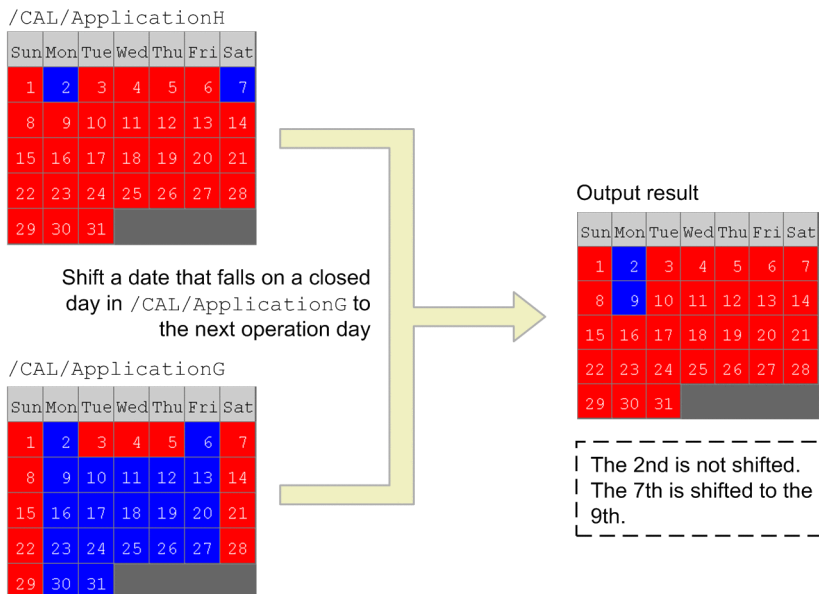

Example 8

The example below combines, with the OR condition, calendar information for two business days after the cutoff date with the calendar information that defines system open days, and then outputs the result to the standard output file. This example assumes that calendar information is defined for the following job groups:

- Job group /CAL/BusinessDays that defines business days
- Job group /CAL/CutoffDates that defines cutoff dates
- Job group /CAL/SystemOpenDays that defines system open days

In this case, the command compares calendar information for job group /CAL/CutoffDates with calendar information for job group /CAL/BusinessDays, and then shifts the information for /CAL/CutoffDates back by two open days. Then, the command outputs the result to calendar information file C:\temp\cal.txt.

Next, the command combines calendar information in calendar information file C:\temp\cal.txt with calendar information for job group /CAL/SystemOpenDays with the OR condition, and then outputs the result to the standard output file.

```
ajscalutil -b 2016/5 -e 2016/5 -s af,2 -cg /CAL/BusinessDays -g /CAL/CutoffDates > C:\temp\cal.txt
ajscalutil -b 2016/5 -e 2016/5 -o -g /CAL/SystemOpenDays -f "C:\temp\cal.txt"
```

Output example

```
c1=2016/05/01;
op=2016/05/02;
c1=2016/05/03;
:
c1=2016/05/29;
op=2016/05/30;
op=2016/05/31;
```

ajschange

Format

```
ajschange
  [-F service-name]
  [attribute-information-change-options]
  [schedule-information-change-options]
  [job-information-change-options]
  [relationship-change-options]
  [root-jobnet-execution-order-control-information-change-options]
  [wait-condition-change-options]
  [-R]
  [-L | -E]
  [-T]
  [-G | -N | -J]
  [-S]
  job-name-or-jobnet-name-or-job-group-name...
```

Description

Modifies the definition of a unit.

Execution privileges

You must have any of the following JP1 privileges:

When updating (defining) an element

- JP1_AJS_Admin privilege
- JP1_AJS_Manager privilege
- JP1_AJS_Editor privilege

When changing an attribute of an element using the `-g`, `-o`, or `-m` option

- JP1_AJS_Admin privilege
- Owner of the unit

Cautionary note

If **User who owns** is specified for **Executed by** for the unit, any JP1 user who has a JP1 privilege level for the jobnet other than JP1_AJS_Admin can only modify a unit he or she owns.

If no JP1 resource group is specified for the unit, any user can perform any operation for the unit even if they do not have the above JP1 privilege level.

If no owner is specified for the unit, any user can modify attributes for the unit even if they do not have the above JP1 privilege level.

Arguments

-F *service-name*

Specify the name of the target scheduler service.

You can specify a character string of 1 to 30 bytes.

-R

Modifies the definitions of all jobnets, job groups, and jobs contained in the specified unit.

If you specify this option with the `-L`, `-E`, `-T`, `-G`, `-N`, and/or `-J` options, the system modifies the definitions according to the specification of each option.

-L

Modifies the definitions of job groups, jobnets not registered for execution, and jobs.

If you specify this option with the `-T`, `-N`, and/or `-J` options, the system modifies the definitions of jobnets or jobs not registered for execution according to the specification of each option. You cannot specify this option with the `-E` and/or `-G` option.

-E

Modifies the definitions of jobs and jobnets registered for execution.

If you specify this option with the `-T`, `-N`, and/or `-J` options, the system modifies the definitions of jobnets or jobs registered for execution according to the specification of each option. You cannot specify this option with the `-L` and/or `-G` option.

-T

Modifies the definitions of root jobnets.

If you specify this option with the `-E` or `-L` option, the system modifies the definitions of root jobnets according to the specification of each option. If you specify this option with the `-N` option, the `-N` option is disabled. You cannot specify this option with the `-G` or `-J` option.

-G

Modifies the definitions of job groups.

You cannot specify this option with the `-L`, `-E`, `-T`, `-N`, `-J`, or a relationship change option.

-N

Modifies the definitions of jobnets.

If you specify this option with the `-T` option, this option is disabled. If you specify this option with the `-E` or `-L` option, the system modifies the definitions of jobnets according to the specification of each option. You cannot specify this option with the `-G` or `-J` option.

-J

Modifies the definitions of jobs.

You cannot specify this option with the `-T`, `-G`, or `-N` option or a relationship change option.

-S

Allows you to change the definition of a suspended jobnet or a job in a suspended jobnet, even if the jobnet is already registered for execution.

If you specify this option together with an option that modifies an item that cannot be modified while a jobnet is suspended, the command terminates abnormally.

job-name-or-jobnet-name-or-job-group-name

Specify the name of the job, jobnet or job group for which you want to modify definitions.

You can specify a character string of 1 to 930 bytes.

You can specify more than one job name, jobnet name, or job group name. You should not, however, specify the following pairs of units, which have different definition information:

- Job group and manager job group
- Jobnet and manager jobnet

You can specify a logical host name as a job, jobnet or job group name. You cannot specify an execution ID.

attribute-information-change-options

These options modify the attributes of a unit.

These options are common to all units. (The `-H` and `-I` options are, however, exceptions. You can specify the `-H` and `-I` options only for manager units.)

-m permission-mode

Specify the permission mode when modifying the JP1 user settings for job execution.

You can specify four octal digits.

The following is the meaning of each digit, starting from the left:

1st digit

Specify the handling of the user for job execution

0 to 3: Assumes the JP1 user who has registered the jobnet to be the user for job execution.

4 to 7: Assumes the JP1 user who owns the job to be the user for job execution.

2nd to 4th digits

Specifies any value between 0 and 7.

This option is valid for only jobs. It is invalid if specified for non-job units.

-o owner-name

Modifies the owner of the unit.

You can specify a character string of 1 to 31 bytes.

-g JPI-resource-group-name

Modifies the group name for the owner of the unit.

You can specify a character string of 1 to 63 bytes. Use alphanumeric characters and an underscore (`_`) to specify the name.

-C comment

Modifies the comment for the unit.

You can specify a character string of 1 to 80 bytes.

-H manager-host-name

Modifies the manager host name.

You can specify this option only for a manager unit.

You can specify a character string of 1 to 255 bytes.

-I *manager-unit-name*

Modifies the manager unit name.

You can specify this option only for a manager unit.

You can specify a character string of 1 to 961 bytes.

schedule-information-change-options

These options modify the schedule defined for a jobnet (if you modify the schedule, the system will recalculate the schedule upon the end of command execution).

You can specify these options only for a jobnet.

-D *job-group-name*

Specify the name of the job group in which the target calendar information is defined, when modifying the calendar information.

You can specify a character string of 1 to 930 bytes.

-d [*N*,] { [[*year*/] *month*/] { [+ | * | @] *day* | [+ | * | @] b [-*day*] | [+] { sun | su | mon | mo | tue | tu | wed | we | thu | th | fri | fr | sat | sa } [: { *n* | b }] } | en | ud | undefine }

Modifies the date on which you want to start executing the jobnet.

You can specify up to 144 dates in one command.

To clear all definitions, specify -d 0, ud, or -d 0, undefine.

- *N*

Specify the corresponding rule number if you specify more than one starting date for executing the jobnet.

You can specify a value between 1 and 144.

By default, the system assumes 1 as the rule number (that is, you will modify a schedule having a rule number of 1).

- *year*

Specify the year of the starting date for executing the jobnet.

You can specify a value between 1994 and the value of the SCHEDULELIMIT environment setting parameter for the year. For details about the SCHEDULELIMIT environment setting parameter, see 20.4.2(123) SCHEDULELIMIT in the JP1/Automatic Job Management System 3 Configuration Guide.

By default, the system assumes the year in which you registered the jobnet for execution.

- *month*

Specify the month of the starting date for executing the jobnet.

You can specify value between 1 and 12 for the month.

By default, the system assumes the month in which you registered the jobnet for execution.

- +

Specify the execution start date using the number of days following the base date.

- *

Specify the execution start date using the number of open days following the base date.

- @

Specify the execution start date using the number of closed days following the base date.

- *day*

Specify the day of the execution start date.

You can specify the following values:

When specifying an absolute date

- Year/month/day specification: 1 to last day of specified year/month.
- Month/day specification: 1 to last day of specified month. For February, however, 1 to 29.
- Day specification: 1 to 31.

When specifying a relative date or the number of open or closed days

1 to 35 (days).

If you omit the specification of + (relative date), * (number of open days) or @ (number of closed days), the system assumes an absolute day of the month in which you registered the jobnet for execution.

- `b`
Sets the last day of the month to the jobnet start date.
- `-day`
Specify the starting date for executing the jobnet using the number of days between the date and the end of the month.
You can specify the following values:

When specifying an absolute date

- Year/month/day specification: 0 to (last day of specified year/month -1).
- Month/day specification: 0 to (last day of specified month -1). For February, however, 0 to 28.
- Day specification: 0 to 30.

When specifying a relative date or the number of open or closed days

0 to 34 (days).

You can specify this option with + (relative date), * (number of open days) or @ (number of closed days).

- `sun|su|mon|mo|tue|tu|wed|we|thu|th|fri|fr|sat|sa`
Specify Sunday, Monday, Tuesday, Wednesday, Thursday, Friday and Saturday as the starting date for executing the jobnet.
- `n`
Specify the week for the day; a value between 1 and 5 (specifying 1 for Sunday, for example, indicates the first Sunday of the month).
By default, the system assumes the start date to be the next day of the week after the date when the jobnet was registered for execution and the date when the `ajsschedule` command was executed. If you do not specify anything when either *year* or *month* is specified for the execution start date, the system assumes the first week when you register anything for execution and when you execute the `ajsschedule` command.
- `en`
Changes the defined execution start date to the date on which you registered the jobnet for execution.
- `ud|undefine`
Clears the entire schedule for the jobnet.
If you specify this option, specify 0 for *N* (jobnet rule number).
Specifying this option causes the `-d`, `-t`, `-V`, `-W`, `-K`, `-y`, `-s`, and `-h` options to be disabled.

`-t [N,] [+]hour:minute`

Modifies the time at which you want to start executing the jobnet.

You can specify up to 144 times in one command.

- *N*

Specify the corresponding rule number if you specify more than one starting date for executing the jobnet.

You can specify a value between 1 and 144.

By default, the system assumes 1 as the rule number (that is, you will modify a schedule having a rule number of 1).

- +

Handles the time specified with *hour:minute* as a relative time.

By default, the system handles the specified time as an absolute time.

- *hour:minute*

Specify the starting time for executing the jobnet.

You can specify a value between 0 and 47 for the hour.

You can specify a value between 0 and 59 for the minute.

-V [*N*,] { *hour:minute* | *M-minute* | *U-minute* | *C-minute* }

Modifies the delay time for starting the jobnet.

You can specify up to 144 times in one command.

- *N*

Specify the corresponding rule number if you specify more than one delay time for starting the jobnet.

You can specify a value between 1 and 144.

By default, the system assumes 1 as the rule number (that is, you will modify a schedule having a rule number of 1).

- *hour:minute*

Specify an absolute time.

You can specify a value between 0 and 47 for the hour.

You can specify a value between 0 and 59 for the minute.

- *M-minute*

Specify the number of minutes relative to the starting time for executing the root jobnet.

You can specify a value between 1 and 2,879 for the minute.

- *U-minute*

Specify the number of minutes relative to the starting time for executing the upper-level jobnet.

You can specify a value between 1 and 2,879 for the minute.

- *C-minute*

Specify the number of minutes relative to the starting time for executing the relevant jobnet.

You can specify a value between 1 and 2,879 for the minute.

-W [*N*,] { *hour:minute* | *M-minute* | *U-minute* | *C-minute* }

Modifies the delay time for ending the jobnet.

You can specify up to 144 times in one command.

- *N*

Specify the corresponding rule number if you specify more than one delay time for ending the jobnet.

You can specify a value between 1 and 144.

By default, the system assumes 1 as the rule number (that is, you will modify a schedule having a rule number of 1).

- *hour:minute*

Specify an absolute time.

You can specify a value between 0 and 47 for the hour.

You can specify a value between 0 and 59 for the minute.

- *M-minute*

Specify the number of minutes relative to the starting time for executing the root jobnet.

You can specify a value between 1 and 2,879 for the minute.

- *U-minute*

Specify the number of minutes relative to the starting time for executing the upper-level jobnet.

You can specify a value between 1 and 2,879 for the minute.

- *C-minute*

Specify the number of minutes relative to the starting time for executing the relevant jobnet.

You can specify a value between 1 and 2,879 for the minute.

-K *[N,]linked-rule-number*

Modifies the rule number to be linked with that for the upper-level jobnet if you have more than one schedule defined.

You can specify up to 144 numbers in one command. You cannot specify a rule number for the root jobnet.

- *N*

Specify the rule number for the schedule for the jobnet.

You can specify a value between 1 and 144.

By default, the system assumes 1 as the rule number (that is, you will modify a schedule having a rule number of 1).

- *linked-rule-number*

Specify the rule number for the upper-level jobnet that corresponds to the above rule number.

-Y *[N,]processing-cycle, {y|m|w|d}*

Modifies the processing cycle for the jobnet.

You can specify up to 144 processing cycles.

- *N*

Specify the corresponding rule number if you specify more than one delay time for starting the jobnet.

You can specify a value between 1 and 144.

By default, the system assumes 1 as the rule number (that is, you will modify a schedule having a rule number of 1).

- *processing-cycle, {y|m|w|d}*

Modify the processing cycle and its unit (for example, specify -Y 6, m to process the jobnet at intervals of six months).

- *y*

Specifies the processing cycle in years. You can specify a value between 1 and 9 for the processing cycle.

- *m*

Specifies the processing cycle in months. You can specify a value between 1 and 12 for the processing cycle.

- *w*

Specifies the processing cycle in weeks. You can specify a value between 1 and 5 for the processing cycle.

You cannot specify this if an open day or closed day is used to define the starting date for executing the jobnet. If you specify this, the schedule is calculated assuming that one week is equal to seven open days or seven closed days. We recommend that you specify the processing cycle on a daily basis. A good example would be "7, d", instead of "1, w".

- *d*

Specifies the processing cycle in days. You can specify a value between 1 and 31 for the processing cycle.

`-s [N,] {af|be|no|ca}`

Modifies the method of shifting the execution date if the scheduled date of jobnet execution falls on a closed day in the JP1/AJS3 calendar.

You can specify up to 144 methods in one command.

- *N*

Specify the corresponding rule number if you specify more than one delay time for starting the jobnet.

You can specify a value between 1 and 144.

By default, the system assumes 1 as the rule number (that is, you will modify a schedule having a rule number of 1).

- *af*

Executes the jobnet by shifting the execution day to a day after the scheduled date of execution.

- *be*

Executes the jobnet by shifting the execution day to a day before the scheduled date of execution.

- *no*

Forcibly executes the jobnet even if the scheduled date of execution is a closed day, provided a scheduler service is running.

- *ca*

Does not execute the jobnet if the scheduled date of execution is a closed day.

`-h [N,] shift-days`

If you specify *af* (shifting to a day after the execution day) or *be* (shifting to a day before the execution day) for the `-s` option, the `-h` option specifies the period into which the system can shift the execution day.

You can specify up to 144 periods.

- *N*

Specify the corresponding rule number if you specify more than one delay time for starting the jobnet.

You can specify a value between 1 and 144.

By default, the system assumes 1 as the rule number (that is, you will modify a schedule having a rule number of 1).

- *shift-days*

You can specify a number between 1 and 31 (days). (For example, specify `-s af -h 5` if you want the system to find a substituting execution day by selecting each following day within five days including the scheduled execution day.)

`-p year/month/day`

Modifies the expiration date for jobnet execution.

- *year*

Specify the year of the expiration date.

You can specify a value between 1994 and the value of the `SCHEDULELIMIT` environment setting parameter for the year. For details about the `SCHEDULELIMIT` environment setting parameter, see [20.4.2\(123\) SCHEDULELIMIT](#) in the *JP1/Automatic Job Management System 3 Configuration Guide*.

- *month*

Specify the month of the expiration date.

You can specify value between 1 and 12 for the month.

- *day*
Specify the day of the expiration date.
You can specify a value between 1 and 31 for the day.

-l *number-of-logs-to-keep*

Modifies the number of logs to store the results of jobnet execution.

You can specify a number between 1 and 99 (logs).

You can, however, enable the system setting option to increase the number of generations to up to 999.

-n *priority-value*

Modifies the assumed value of the execution priority for jobs in the jobnet.

You can specify a value between 1 and 5.

The lowest priority is 1 and the highest is 5.

-b {y|w|a|n}

Modifies the hold attribute for the jobnet. If you specify w or a for a nested jobnet, the system assumes n.

- y
Holds the execution of the jobnet.
- w
Holds execution only if the previous execution of the jobnet has terminated abnormally or with a warning.
- a
Holds execution only if the previous execution of the jobnet has terminated abnormally.
- n
Does not hold the execution of the jobnet.

One of the job information change options (the option for modifying the job hold attribute) has the same name as this option. Be careful not to mix up these options when specifying wildcard characters if there are several types of units.

job-information-change-options

These options modify the definition information for a job.

The following table lists the job information change options that can be used for individual jobs.

Table 3–2: Job information change options that can be used for individual jobs

| No. | Job | Job information change option |
|-----|------------------------------------|---|
| 1 | Unix job and Unix job for recovery | <ul style="list-style-type: none"> • -c <i>command-text</i> • -z <i>script-file-name</i> • -v <i>environment-variable-file-name</i> • -i <i>standard-input-file-name</i> • -u <i>standard-output-file-name</i> • -e <i>standard-error-output-file-name</i> • -w <i>warning-threshold</i> • -a <i>abnormal-threshold</i> • -j <i>job-execution-agent-host-name</i> • -U <i>remote-execution-user</i> • -b {y n} |
| 2 | PC job and PC job for recovery | <ul style="list-style-type: none"> • -z <i>script-file-name</i> • -v <i>environment-variable-file-name</i> |

| No. | Job | Job information change option |
|-----|--|---|
| 2 | PC job and PC job for recovery | <ul style="list-style-type: none"> • -i <i>standard-input-file-name</i> • -u <i>standard-output-file-name</i> • -e <i>standard-error-output-file-name</i> • -w <i>warning-threshold</i> • -a <i>abnormal-threshold</i> • -j <i>job-execution-agent-host-name</i> • -U <i>remote-execution-user</i> • -b {y n} |
| 3 | custom Unix job and custom Unix job for recovery | <ul style="list-style-type: none"> • -c <i>command-text</i> • -z <i>script-file-name</i> • -v <i>environment-variable-file-name</i> • -i <i>standard-input-file-name</i> • -u <i>standard-output-file-name</i> • -e <i>standard-error-output-file-name</i> • -w <i>warning-threshold</i> • -a <i>abnormal-threshold</i> • -j <i>job-execution-agent-host-name</i> • -U <i>remote-execution-user</i> • -b {y n} |
| 4 | custom PC job and custom PC job for recovery | <ul style="list-style-type: none"> • -U <i>remote-execution-user</i> • -e <i>standard-error-output-file-name</i> • -w <i>warning-threshold</i> • -a <i>abnormal-threshold</i> • -j <i>job-execution-agent-host-name</i> • -U <i>remote-execution-user</i> • -b {y n} |
| 5 | QUEUE job and QUEUE job for recovery | <ul style="list-style-type: none"> • -z <i>script-file-name</i> • -w <i>warning-threshold</i> • -a <i>abnormal-threshold</i> • -b {y n} • -q <i>queue-name</i> • -k <i>job-name</i> |
| 6 | OR job and OR job for recovery | None |
| 7 | judgment job and judgment job for recovery | -b {y n} |
| 8 | flexible job and flexible job for recovery | <ul style="list-style-type: none"> • -z <i>script-file-name</i> • -w <i>warning-threshold</i> • -a <i>abnormal-threshold</i> • -j <i>relay-agent-name</i> • -b {y n} |
| 9 | HTTP Connection job and HTTP Connection job for recovery | <ul style="list-style-type: none"> • -u <i>standard-output-file-name</i> • -e <i>standard-error-output-file-name</i> • -w <i>warning-threshold</i> • -a <i>abnormal-threshold</i> • -j <i>job-execution-agent-host-name</i> • U <i>remote-execution-user</i> • -b {y n} |

- c *command-text*
Modifies a command text.
You can specify a character string of 1 to 1,023 bytes.
- z *script-file-name*
Modifies the name of the script file for a Unix job. For a PC job, flexible job, or QUEUE job, this option modifies the name of the execution file.
You can specify a character string of 1 to 511 bytes.
- v *environment-variable-file-name*
Modifies the environment variable file name.
Use a full path to specify the file name.
You can specify a character string of 1 to 511 bytes.
- i *standard-input-file-name*
Modifies the standard input file name.
Use a full path to specify the file name.
You can specify a character string of 1 to 511 bytes.
- u *standard-output-file-name*
Modifies the standard output file name.
Use a full path to specify the file name.
You can specify a character string of 1 to 511 bytes.
You can output the standard output file as a temporary file by specifying `$JP1AJS2_JPQSTDOUTTEMP$`.
You can also specify a macro variable.
- e *standard-error-output-file-name*
Modifies the standard error output file name.
Use a full path to specify the file name.
You can specify a character string of 1 to 511 bytes.
- w *warning-threshold*
Modifies the threshold value for completion with a warning.
You can specify a value between 0 and 2,147,483,647.
If the specified value is greater than the abnormal threshold, the value is defined as the abnormal threshold value.
- a *abnormal-threshold*
Modifies the threshold value for abnormal end.
You can specify a value between 0 and 2,147,483,647.
If the specified value is smaller than the abnormal threshold, the value is defined as the abnormal threshold value.
A value that is smaller than the lower limit or greater than the upper limit of the return code to be automatically retried cannot be specified if the retry settings for the unit to be updated is set and a return code to be automatically retried is specified.
- j *job-execution-agent-host-name-or-relay-agent-name*
Modifies the name of the job execution agent host or the relay agent.
For a flexible job, if the value for @SYSTEM is used for update, the definition of the relay agent name is initialized.
You can specify a character string of 1 to 255 bytes.
- U *remote-execution-user*
Modifies the name of the user who executes the job.

You can specify a character string of 1 to 63 bytes.

`-b {y|n}`

Modifies the hold attribute for the job.

This option cannot be specified for a job specified in a start condition.

- `y`
Holds the execution of the job.
- `n`
Does not hold the execution of the job.

One of the schedule information change options (the option for modifying the job hold attribute) has the same name as this option. Be careful not to mix up these options when specifying wildcard characters if there are several types of units.

`-q queue-name`

Modifies the name of the queue for queuing the job.

You can specify a character string of 1 to 63 bytes.

`-k job-name`

Modifies the job name.

You can specify a character string of 1 to 63 bytes.

relationship-change-options

These options modify the relationship of the execution order for jobnets and jobs. You can specify these options only for a jobnet.

You can specify up to 20 `-A` options (make relation options) and 20 `-B` options (break relation options) in one command.

`-A preceding-unit-name, succeeding-unit-name [, {seq|con}]`

Specify the names of the preceding and succeeding units between which you want to create a relationship (associate units). You must also specify the connection type.

You can specify a character string of 1 to 30 bytes for each unit name (*preceding-unit-name* and *succeeding-unit-name*).

If the relation line is already set for the preceding and succeeding units whose relationship is to be set, the command returns 0 and ends normally.

- `seq`
Specifies forward connection.
- `con`
Specifies the judgment connection of a judgment job and a dependent unit.

The system does not create a relationship in any of the following cases:

- If the same unit name is specified for the preceding unit as well as the succeeding unit
- If the unit of the specified preceding unit name or succeeding unit name does not exist
- If a recovery unit is specified as the preceding unit name, and a regular unit is specified as the succeeding unit name
- If you attempt to set a reverse relationship for units between which you have already set a relationship
- If you specify a relationship and cancel a relationship, at the same time, between the same preceding unit and succeeding unit
- If you specify a job group, manager job group, manager jobnet, or root jobnet

- If there are two or more preceding units when the succeeding unit is a judgment job
- If the preceding unit is other than an event job or a custom event job when the succeeding unit is an OR job
- If you specify a unit other than a judgment job as the preceding unit for a judgment connection
- If the judgment connection of a judgment job and a dependent unit makes other than 1-to-1 matching
- If you specify a start condition unit name for the name of the preceding or succeeding unit

–B *preceding-unit-name, succeeding-unit-name*

Specify the names of the preceding and succeeding units between which you want to break a relationship (cancels the association between units).

You can specify a character string of 1 to 30 bytes for each unit name.

If the relation line does not exist for the preceding and succeeding units whose relationship is to be broken, the command returns 0 and ends normally.

root-jobnet-execution-order-control-information-change-options

These options modify the information that control the execution order of root jobnets based on jobnet connectors. You can specify these options only for a root jobnet that has not been registered, and for a planning group whose units have not been registered.

–M *whether-to-control-the-root-jobnet-execution-order*

Specify whether to control the root jobnet execution order.

- *y*: The root jobnet execution order is controlled.
- *n*: The root jobnet execution order is not controlled.

If you change the value of this option from *y* to *n*, the specifications of the –O (jobnet connector name), –Qh (host to connect), and –Qs (connection service name) options are cleared (neither *y* nor *n* is set). For the –P (root jobnet execution order control method) and –Qx (linkage of root jobnet execution order control between scheduler services) options, *n* is set.

–O *jobnet-connector-name*

Specify the full name of the unit of the jobnet connector to be connected. You can specify a character string of 1 to 930 bytes.

You can specify this option if *y* is specified for the –M option. Specifying this option if *n* is specified for the –M option results in an error.

–P *root-jobnet-execution-order-control-method*

Specify the method for controlling the root jobnet execution order.

- *y*: Root jobnets are executed synchronously with jobnet connectors.
- *n*: Root jobnets are executed asynchronously with jobnet connectors.

You can specify this option if *y* is specified for the –M option. Specifying this option if *n* is specified for the –M option results in an error.

–Qx *linkage-of-root-jobnet-execution-order-control-between-scheduler-services*

Specify whether to establish linkage between scheduler services when the execution order of root jobnets is controlled.

You can only specify this option for a planning group whose units have not been registered, and for a root jobnet that has not been registered.

If you change the value of this option from *y* to *n*, the specifications of the –Qh (host to connect) and –Qs (connection service name) options are cleared (neither *y* nor *n* is set).

- *y*

Linkage between scheduler services is established.

Root jobnet execution order control is linked with jobnet connectors including those defined on other hosts or those defined in other scheduler services.

- n

Linkage between scheduler services is not established.

Root jobnet execution order control is linked with only jobnet connectors defined in the same scheduler service.

-Qh *connection-host-name*

Specify the name of the host on which a jobnet connector to be connected is defined. You can specify a character string of 1 to 255 bytes. You cannot specify space, tab, or linefeed characters.

You can specify this option only if *y* is specified for the **-Qx** option (linkage of root jobnet execution order control between scheduler services).

-Qs *connection-service-name*

Specify the name of the scheduler service on which a jobnet connector to be connected is defined. You can specify a character string of 1 to 30 bytes. You cannot specify a null string ("") to reset the scheduler service name definition to the default status.

You can specify this option only if *y* is specified for the **-Qx** option (linkage of root jobnet execution order control between scheduler services).

wait-condition-change-options

These options modify wait conditions.

You can apply these options to suspended units by specifying them together with the **-S** option.

-Qm {and|or}

Specify the wait method. This option must be specified together with the **-Qn** option and the **-Qu** option if no units whose ends are being waited for are defined for the target unit.

If "" is specified for this option, **and** is assumed.

- and

The unit starts executing when all units whose ends are being waited for finish executing.

- or

The unit starts executing when any one of the units whose ends are being waited for finish executing.

-Qn {y|n}

Specify how the unit behaves when there are no applicable generations of the root jobnet of the unit whose end is being waited for. This option must be specified together with the **-Qm** option and the **-Qu** option if no units whose ends are being waited for are defined for the target unit.

If "" is specified for this option, **n** is assumed.

- y

Start executing.

- n

Do not start executing.

-Qu *name-of-unit-whose-end-is-being-waited-for*

Specify the full path name of an additional unit whose end is being waited for by a wait condition. You can specify a character string of 1 to 930 bytes. The unit you specify is added to the units already defined for the wait condition.

If you specify a unit that is already defined as a unit whose end is being waited for by that wait condition, the command ends normally without the unit being added.

You cannot add more than 32 units whose ends are being waited for.

You can specify multiple instances of this option together with the `-Qd` option (which deletes units whose ends are being waited for).

If you specify this option together with the `-Qd` option and specify the same unit name in both options, the `-Qd` option takes precedence and the specified unit is deleted.

This option must be specified together with the `-Qm` option and the `-Qn` option if the command targets a unit for which no units whose ends are being waited for are defined.

`-Qd` *name-of-unit-whose-end-is-being-waited-for-to-delete*

Specify the full path name of a unit whose end is being waited for that you want to delete from a wait condition. You can specify a character string of 1 to 930 bytes. The unit you specify is removed from the wait conditions defined for the target unit.

If you specify a unit that is not defined as a unit whose end is being waited for by the wait condition, the command ends normally.

You can specify multiple instances of this option together with the `-Qu` option (which adds units whose ends are being waited for).

If you specify this option together with the `-Qu` option and specify the same unit name for both options, the `-Qd` option takes precedence and the specified unit is deleted.

`-Qz`

Deletes all units whose ends are being waited for defined in the wait condition.

You cannot specify this option with the `-Qu` option or `-Qd` option.

`-Qg` {*exec* | *execdefer* | *none*}

If a jobnet with start conditions is specified as the jobnet whose end is being waited for, specify the behavior when the execution generation ends abnormally.

To specify this option for a unit for which no unit whose end is being waited for is specified, you must also specify the `-Qm`, `-Qn`, and `-Qu` options.

If "" is specified for this option, *none* is assumed.

- *exec*
Start executing.
- *execdefer*
Do not start executing. Note, however, that if the execution generation is in the *Skipped so not exe.* status, execution starts.
- *none*
Do not start executing.

`-QU` {*y* | *n*}

Specify the behavior when a jobnet with start conditions is specified as the jobnet whose end is being waited for, and the status of the monitoring generation changes to *Unmonitored + Ended*.

To specify this option for a unit for which no unit whose end is being waited for is specified, you must also specify the `-Qm`, `-Qn`, and `-Qu` options.

If "" is specified for this option, *n* is assumed.

- *y*
Start executing.
- *n*
Do not start executing.

Notes

- Either of the following users can change the unit definition:
 - A user who was granted the update privilege when the unit was defined or when the unit's attributes were changed
 - A JP1 user mapped to the OS user who has Administrators or superuser privilegesNote, however, that if `yes` is set after changing the `ADMACLIMIT` environment setting parameter from its default, even a JP1 user who was mapped to an OS user with Administrators or superuser privileges must have the update privilege.
- We recommend that you not execute this command during the execution of a jobnet. (This command terminates abnormally if some other process is using the target unit. You cannot use JP1/AJS3 - View to manipulate or update a unit while you are modifying the definition of the unit with this command. You cannot execute a unit while you are manipulating it.)
- We recommend that you cancel the registration of jobnets before attempting to change the contents of the definitions of registered jobnets (Otherwise, you cannot change the related information). Use the `ajsleave` command when canceling the registration of jobnets.
- If you specify any invalid option for the unit, this command will terminate abnormally. Do not use wildcard characters for modification (use a regular expression, such as `A*` for a name starting with A).
- Modifying the schedule disables any temporary plan modification you specified previously.
- If you shift the execution start day to a day previous to the target day, the schedule for the past becomes invalid; the system does not execute the jobnet.
- If you use the command to define a jobnet, the system does not check the consistency of the execution order of units. A jobnet in which units will result in a loop or a judgment job without any associated dependent units results in an error and is placed in *Invalid exe. seq.* status.
- To leave information undefined (default), specify "" for the option.
- If you specify the `-t`, `-v`, `-w`, `-k`, `-y`, `-s`, or `-h` option with a rule number not contained in the schedule definition for the jobnet, the command will end normally, without adding any schedule. When adding a schedule rule, also specify the `-d` option.
- If the release target jobnet (root jobnet for which release entry is made) is changed, the jobnet definitions in *Being applied* status are also changed.
- You cannot control the execution order of release target jobnets (root jobnets for which release entry is made).
- You cannot use the `-A` or `-B` option to change the definition of a relation line associated with a suspended unit. To change a relation line for a suspended unit, use the `ajschgnet` command.
- Execute changes in schedule information when there are only a few tasks. If you specified schedule-information-change-options, while this command is being executed, the system suppresses the execution of root jobnets registered for execution in the same scheduler service as jobnets that change schedule information, which might impact tasks. However, for jobnets with start conditions whose status is *Now monitoring* before the change in definitions, if the start conditions are established then those jobnets will be executed.

Return values

| | |
|--|--------------|
| 0 | Normal end |
| Multiple of 4 within the range from 4 to 124 | Abnormal end |

Additional information

To leave information undefined (default) for an attribute information change, schedule information change or job information change option, specify "" for the option.

Example 1

The following command changes the starting time for executing jobnet `net1` to 17:00 (absolute time) on every Friday in October 2010:

```
ajschange -d 2010/10/fr -y 1, w -t 17:00 net1
```

Example 2

The following command changes the standard output file for job `net1/job1` to `/dev/null`:

```
ajschange -u /dev/null net1/job1
```

Example 3

The following command creates a relationship between two jobs, `net1/job1` and `net1/job2`:

```
ajschange -A job1, job2 net1
```

Example 4

The following command sets the execution order control information for root jobnet `/net1` so that it is executed synchronously with jobnet connector `/net2/netcon1`:

```
ajschange -M y -O /net2/netcon1 -P y /net1
```

The following command cancels the execution order control for root jobnet `/net1`:

```
ajschange -M n /net1
```

ajschgjob

Format

```
ajschgjob
  [-F service-name]
  [job-common-information-change-options]
  [Unix-job/PC-job/Queue-job/custom-job/flexible-job/HTTP-connection-job-
information-change-options]
  [judgment-job-information-change-options]
  [JP1-event-reception-monitoring-job-information-change-options]
  [file-monitoring-job-information-change-options]
  [email-reception-monitoring-job-information-change-options]
  [message-queue-reception-monitoring-job-information-change-options]
  [MSMQ-reception-monitoring-job-information-change-options]
  [log-file-monitoring-job-information-change-options]
  [Windows-event-log-monitoring-job-information-change-options]
  [execution-interval-control-job-information-change-options]
  [JP1-event-sending-job-information-change-options]
  [email-sending-job-information-change-options]
  [message-queue-sending-job-information-change-options]
  [MSMQ-sending-job-information-change-options]
  [HP-NNM-status-report-job-information-change-options]
  [local-power-control-job-information-change-options]
  [remote-power-control-job-information-change-options]
  [custom-event-job-information-change-options]
  [-R]
  [-L | -E]
  [-J]
  job-name-or-jobnet-name-or-job-group-name...
```

Description

Modifies the definitions of jobs.

Execution privileges

You must have any of the following JP1 privileges:

- JP1_AJS_Admin privilege
- JP1_AJS_Manager privilege
- JP1_AJS_Editor privilege

Cautionary note

If **User who owns** is specified for **Executed by** for the unit, any JP1 user who has a JP1 privilege level for the jobnet other than JP1_AJS_Admin can only modify a unit he or she owns.

If no JP1 resource group is specified for the unit, any user can perform any operation for the unit even if they do not have the above JP1 privilege level.

Arguments

-F *service-name*

Specify the name of the target scheduler service.

You can specify a character string of 1 to 30 bytes.

-R

Modifies the definitions of all jobs contained in the specified unit.

If you specify this option with the `-L`, `-E`, and/or `-J` options, the system modifies the definitions according to the specification of each option.

-L

Modifies the definitions of jobs in jobnets not registered for execution.

If you specify this option with the `-J` option, the system modifies the definitions of jobs in unregistered jobnets. You cannot specify this option with the `-E` option.

-E

Modifies the definitions of jobs in jobnets registered for execution.

If you specify this option with the `-J` option, the system modifies the definitions of jobs in registered jobnets. You cannot specify this option with the `-L` option.

-J

Modifies the definitions of jobs.

job-name-or-jobnet-name-or-job-group-name

Specify the full name of the job for which you want to modify definitions. You can also specify the full name of the job, jobnet, or job group with the `-R`, `-E`, `-L`, or `-J` option.

You can specify a character string of 1 to 930 bytes.

You can specify more than one job name, jobnet name, or job group names.

You can specify a logical host name as a job, jobnet or job group name. You cannot specify an execution ID.

job-common-information-change-options

These options modify information common to all jobs.

`-ex "execution-agent-host-name-or-relay-agent-name"`

Modifies the name of the job execution agent host or the relay agent.

For a flexible job, if the value for `@SYSTEM` is used for update, the definition of the relay agent name is initialized.

You can specify a character string of 1 to 255 bytes.

You cannot specify this option for a `QUEUE` job, judgment job, or `OR` job.

`-et execution-time-out-period`

Modifies the execution time-out period.

You can specify a value between 1 and 1,440 for the minute.

You cannot specify this option for a `QUEUE` job, judgment job, or `OR` job. The same is applicable to any job within the start conditions.

`-ha {y|n}`

Modifies the hold attribute.

You cannot specify this option for an `OR` job. The same is applicable to any job within the start conditions.

- `y`
Holds the execution of a job.
- `n`
Does not hold the execution of a job.

`-es {kl|nr|wr|an}`

Modify the time-out state of the event job and the custom event job after the execution time-out period elapses. This option is valid for the following information change options:

- JP1 event reception monitoring job
- File monitoring job
- Email reception monitoring job
- Message-queue message reception monitoring job
- MSMQ message reception monitoring job
- Log file monitoring job
- Windows event-log monitoring job
- Execution interval control job
- Custom event job

You can specify the following characters with this option:

- `kl`: Killed
- `nr`: Ended normally
- `wr`: Ended with warning
- `an`: Ended abnormally

You can specify this option only for an event job and a custom event job. You cannot specify this option for an event job and a custom event job within the start condition.

If you specify this option for a unit for which no execution time-out period has been specified, you must specify an execution time-out period using the `-et` option.

`-fd time-required-for-execution`

Change the time-required-for-execution within which the job is expected to be terminated. A delay of job execution is detected based on this time.

You can specify a value from 1 to 1,440 (in minutes). Specifying a non-numeric character or a numeric value outside the 1-1,440 range results in an error.

You cannot specify this for a judgment job or an OR job. If you specify this option for a judgment job or OR job, the option is ignored and processing continues.

Unix-job/PC-job/Queue-job/custom-job/flexible-job/HTTP-connection-job-information-change-options

These options modify job definition information.

The following table lists the information change options that can be used for individual jobs.

Table 3–3: Information change options that can be used for individual jobs

| No. | Job | Information change options |
|-----|------------------------------------|--------------------------------------|
| 1 | Unix job and Unix job for recovery | <code>-te <i>command-text</i></code> |

| No. | Job | Information change options |
|-----|------------------------------------|---|
| 1 | Unix job and Unix job for recovery | <p> <i>-sc script-file-name</i> <i>-pm parameter</i> <i>-wk work-path-name</i> <i>-ev environment-variable-file-name</i> <i>-en environment-variable</i> <i>-si standard-input-file-name</i> <i>-so standard-output-file-name</i> <i>-se standard-error-output-file-name</i> <i>-oa {new add}</i> <i>-ea {new add}</i> <i>-pr execution-priority</i> <i>-un job-execution-user-name</i> <i>-jd {nm ab cod mdf exf}</i> <i>-wt warning-threshold</i> <i>-th abnormal-threshold</i> <i>-jf end-judgment-file-name</i> <i>-Ab {y n}</i> <i>-rs lower-limit-of-return-code-to-be-automatically-retried</i> <i>-re upper-limit-of-return-code-to-be-automatically-retried</i> <i>-rc maximum-number-of-retry-executions</i> <i>-ri retry-interval</i> <i>-s1 transfer-source-file-name-1</i> <i>-d1 transfer-destination-file-name-1</i> <i>-t1 {sav del}</i> <i>-s2 transfer-source-file-name-2</i> <i>-d2 transfer-destination-file-name-2</i> <i>-t2 {sav del}</i> <i>-s3 transfer-source-file-name-3</i> <i>-d3 transfer-destination-file-name-3</i> <i>-t3 {sav del}</i> <i>-s4 transfer-source-file-name-4</i> <i>-d4 transfer-destination-file-name-4</i> <i>-t4 {sav del}</i> <i>-jt {q n}</i> </p> |
| 2 | PC job and PC job for recovery | <p> <i>-sc script-file-name</i> <i>-pm parameter</i> <i>-wk work-path-name</i> <i>-ev environment-variable-file-name</i> <i>-en environment-variable</i> <i>-si standard-input-file-name</i> <i>-so standard-output-file-name</i> <i>-se standard-error-output-file-name</i> <i>-oa {new add}</i> <i>-ea {new add}</i> <i>-pr execution-priority</i> <i>-un job-execution-user-name</i> <i>-jd {nm ab cod mdf exf}</i> <i>-wt warning-threshold</i> <i>-th abnormal-threshold</i> </p> |

| No. | Job | Information change options |
|-----|--|---|
| 2 | PC job and PC job for recovery | <p> <i>-jf end-judgment-file-name</i> <i>-Ab {y n}</i> <i>-rs lower-limit-of-return-code-to-be-automatically-retried</i> <i>-re upper-limit-of-return-code-to-be-automatically-retried</i> <i>-rc maximum-number-of-retry-executions</i> <i>-ri retry-interval</i> <i>-s1 transfer-source-file-name-1</i> <i>-d1 transfer-destination-file-name-1</i> <i>-t1 {sav del}</i> <i>-s2 transfer-source-file-name-2</i> <i>-d2 transfer-destination-file-name-2</i> <i>-t2 {sav del}</i> <i>-s3 transfer-source-file-name-3</i> <i>-d3 transfer-destination-file-name-3</i> <i>-t3 {sav del}</i> <i>-s4 transfer-source-file-name-4</i> <i>-d4 transfer-destination-file-name-4</i> <i>-t4 {sav del}</i> <i>-jt {q n}</i> </p> |
| 3 | custom Unix job and custom Unix job for recovery | <p> <i>-te command-text</i> <i>-sc script-file-name</i> <i>-pm parameter</i> <i>-wk work-path-name</i> <i>-ev environment-variable-file-name</i> <i>-en environment-variable</i> <i>-si standard-input-file-name</i> <i>-so standard-output-file-name</i> <i>-se standard-error-output-file-name</i> <i>-oa {new add}</i> <i>-ea {new add}</i> <i>-pr execution-priority</i> <i>-un job-execution-user-name</i> <i>-jd {nm ab cod mdf exf}</i> <i>-wt warning-threshold</i> <i>-th abnormal-threshold</i> <i>-jf end-judgment-file-name</i> <i>-Ab {y n}</i> <i>-rs lower-limit-of-return-code-to-be-automatically-retried</i> <i>-re upper-limit-of-return-code-to-be-automatically-retried</i> <i>-rc maximum-number-of-retry-executions</i> <i>-ri retry-interval</i> <i>-s1 transfer-source-file-name-1</i> <i>-d1 transfer-destination-file-name-1</i> <i>-t1 {sav del}</i> <i>-s2 transfer-source-file-name-2</i> <i>-d2 transfer-destination-file-name-2</i> <i>-t2 {sav del}</i> <i>-s3 transfer-source-file-name-3</i> <i>-d3 transfer-destination-file-name-3</i> </p> |

| No. | Job | Information change options |
|-----|--|---|
| 3 | custom Unix job and custom Unix job for recovery | -t3 {sav del} -s4 <i>transfer-source-file-name-4</i> -d4 <i>transfer-destination-file-name-4</i> -t4 {sav del} |
| 4 | custom PC job and custom PC job for recovery | -so <i>standard-output-file-name</i> -se <i>standard-error-output-file-name</i> -pr <i>execution-priority</i> -un <i>job-execution-user-name</i> -jd {nm ab cod mdf exf} -wt <i>warning-threshold</i> -th <i>abnormal-threshold</i> -jf <i>end-judgment-file-name</i> -Ab {y n} -rs <i>lower-limit-of-return-code-to-be-automatically-retried</i> -re <i>upper-limit-of-return-code-to-be-automatically-retried</i> -rc <i>maximum-number-of-retry-executions</i> -ri <i>retry-interval</i> |
| 5 | QUEUE job and QUEUE job for recovery | -sc <i>script-file-name</i> -pm <i>parameter</i> -pr <i>execution-priority</i> -jd {nm ab cod} -wt <i>warning-threshold</i> -th <i>abnormal-threshold</i> -Ab {y n} -rs <i>lower-limit-of-return-code-to-be-automatically-retried</i> -re <i>upper-limit-of-return-code-to-be-automatically-retried</i> -rc <i>maximum-number-of-retry-executions</i> -ri <i>retry-interval</i> -qu <i>queue-name</i> -qm <i>queue-manager-host-name</i> -rq <i>job-name</i> -s1 <i>transfer-source-file-name-1</i> -d1 <i>transfer-destination-file-name-1</i> -s2 <i>transfer-source-file-name-2</i> -d2 <i>transfer-destination-file-name-2</i> -s3 <i>transfer-source-file-name-3</i> -d3 <i>transfer-destination-file-name-3</i> -s4 <i>transfer-source-file-name-4</i> -d4 <i>transfer-destination-file-name-4</i> |
| 6 | flexible job and flexible job for recovery | -sc <i>script-file-name</i> -pm <i>parameter</i> -en <i>environment-variable</i> -jd {nm ab cod mdf exf} -wt <i>warning-threshold</i> -th <i>abnormal-threshold</i> -jf <i>end-judgment-file-name</i> -Ab {y n} -rs <i>lower-limit-of-return-code-to-be-automatically-retried</i> |

| No. | Job | Information change options |
|-----|--|--|
| 6 | flexible job and flexible job for recovery | -re <i>upper-limit-of-return-code-to-be-automatically-retried</i> -rc <i>maximum-number-of-retry-executions</i> -ri <i>retry-interval</i> -da <i>destination-or-broadcast-agent</i> -fg {none sync async} |
| 7 | HTTP Connection job and HTTP Connection job for recovery | -so <i>standard-output-file-name</i> -se <i>standard-error-output-file-name</i> -pr <i>execution-priority</i> -un <i>job-execution-user-name</i> -jd {nm ab cod mdf exf} -wt <i>warning-threshold</i> -th <i>abnormal-threshold</i> -jf <i>end-judgment-file-name</i> -Ab {y n} -rs <i>lower-limit-of-return-code-to-be-automatically-retried</i> -re <i>upper-limit-of-return-code-to-be-automatically-retried</i> -rc <i>maximum-number-of-retry-executions</i> -ri <i>retry-interval</i> -HC <i>connection-configuration-file-name</i> -HK {GET POST PUT DELETE} -HE {y n} -HS <i>transmission-information-file-name</i> -HU <i>transmission-information-file-name-(URL-parameter)</i> -HM <i>transmission-information-file-name-(message-body)</i> -HT <i>statuses-store-file-name</i> -HD {diff same} -HH <i>received-header-store-file-name</i> -HB <i>received-body-store-file-name</i> -HR <i>return-code-1 : HTTP-status-code-1 [, HTTP-status-code-2 . . .] ;</i> |

-te *command-text*

Modifies a command text.

You can specify a character string of 1 to 1,023 bytes.

-sc *script-file-name*

Modifies the name of the script file for a Unix job. For a PC job, flexible job, or QUEUE job, this option modifies the name of the execution file.

You can specify a character string of 1 to 511 bytes.

-pm *parameter*

Modifies a parameter for the execution file.

You can specify a character string of 1 to 1,023 bytes.

-wk *work-path-name*

Modifies the work path (current path) name.

You can specify a character string of 1 to 511 bytes.

-ev *environment-variable-file-name*

Modifies the environment variable file name.

You can specify a character string of 1 to 511 bytes.

Use a full path name to specify the environment variable file name.

For notes on defining environment variables, see *A. Notes on Defining Environment Variables and an Environment Variable File*.

`-en environment-variable`

Modifies the environment variable.

You can specify a character string of 1 to 20,479 bytes.

For a flexible job, you can specify multiple character strings up to 10,240 bytes in total. For a job other than a flexible job, you can specify multiple character strings up to 20,479 bytes in total.

For notes on defining environment variables, see *A. Notes on Defining Environment Variables and an Environment Variable File*.

`-si standard-input-file-name`

Modifies the standard input file name.

You can specify a character string of 1 to 511 bytes.

Use a full path name to specify the standard input file name.

`-so standard-output-file-name`

Modifies the standard output file name.

You can specify a character string of 1 to 511 bytes.

Use a full path name to specify the standard output file name.

You can output the standard output file as a temporary file by specifying `$JP1AJS2_JPQSTDOUTTEMP$`.

You can also specify a macro variable.

`-se standard-error-output-file-name`

Modifies the standard error output file name.

You can specify a character string of 1 to 511 bytes.

Use a full path name to specify the standard error output file name.

`-oa {new|add}`

Modifies the method for updating the information in the standard output file.

- `new`
Outputs information to a new standard output file.
- `add`
Adds information to an existing standard output file.

`-ea {new|add}`

Modifies the method for updating the information in the standard error output file.

- `new`
Outputs information to a new standard error output file.
- `add`
Adds information to an existing standard error output file.

`-pr execution-priority`

Modifies the priority for job execution.

You can specify a value between 1 and 5.

The lowest priority is 1 and the highest is 5.

`-un job-execution-user-name`

Modifies the name of the user for executing the job.

You can specify a character string of 1 to 63 bytes.

`-jd {nm|ab|cod|mdf|exf}`

Modifies the type of end judgment.

If this value is changed to a value other than `cod`, the setting values for the `-Ab`, `-rs`, `-re`, `-rc`, and `-ri` options related to the retry setting are initialized.

- `nm`
Assumes every termination of the job to be a normal end.
- `ab`
Assumes every termination of the job to be an abnormal end.
- `cod`
Assumes a normal end if the return code is below the specified value.
- `mdf`
Assumes a normal end if the job has updated a file.
You cannot specify this option for a QUEUE job or recovery jobs for them.
- `exf`
Assumes a normal end if the job has created a file.
You cannot specify this option for a QUEUE job or recovery jobs for them.

`-wt warning-threshold`

Modifies the threshold value for completion with a warning.

You can specify a value between 0 and 2,147,483,647.

If the specified value is greater than the abnormal threshold, the value is defined by using the abnormal threshold value.

`-th abnormal-threshold`

Modifies the threshold value for abnormal end.

You can specify a value between 0 and 2,147,483,647.

If the specified value is smaller than the warning threshold, the value is defined by using the warning threshold value.

A value that is smaller than the lower limit or greater than the upper limit of a return code requiring automatic retry cannot be specified if the retry settings for the job to be updated are set and a return code requiring automatic retry is specified.

`-jf end-judgment-file-name`

Modifies the name of the end judgment file.

`-Ab {y|n}`

Changes the behavior of automatic retry when a job ends abnormally.

- `y`
Performs automatic retry when a job ends abnormally.
- `n`
Automatic retry is not performed if a job ends abnormally.

`y` can be specified for this option only when the value specified for the `-jd` option is `cod`.

If this value is changed from `y` to `n`, all related settings for the `-rs`, `-re`, `-rc`, and `-ri` options are deleted. In addition, when `n` is specified for this option, if the `-rs`, `-re`, `-rc`, and `-ri` options are specified together with this option, they are ignored.

This option cannot be defined for the passing information setting job.

`-rs` *lower-limit-of-return-code-to-be-automatically-retried*

Specify the lower limit for the return codes to be automatically retried. When automatic retry on abnormal end is set, if the return code output on an abnormal end is equal to or greater than the value specified for this option, automatic retry is performed.

You can specify a value from 1 to 4,294,967,295. If "" is specified, the value is treated as undefined, and the value of the abnormal threshold + 1 for the end judgment is assumed at job execution.

A value that is equal to or smaller than the abnormal threshold and a value that is greater than the upper limit of the return code to be automatically retried cannot be specified. In addition, if the lower and upper limits of the return code to be automatically retried (enabled when the job is executed) constitute an invalid range, an error occurs.

This option cannot be defined for the passing information setting job.

`-re` *upper-limit-of-return-code-to-be-automatically-retried*

Specify the upper limit for the return codes to be automatically retried. When automatic retry on abnormal end is set, if the return code output on an abnormal end is equal to or smaller than the value specified for this option, automatic retry is performed.

You can specify a value from 1 to 4,294,967,295. If "" is specified, the value is treated as undefined, and the maximum value (4,294,967,295) is assumed at job execution.

A value that is equal to or smaller than the abnormal threshold and a value that is smaller than the lower limit for the return codes to be automatically retried cannot be specified. In addition, if the lower and upper limits of the return codes to be automatically retried constitute an invalid range, an error occurs.

This option cannot be defined for the passing information setting job.

`-rc` *maximum-number-of-retry-executions*

Specify the maximum number of retry executions for automatic retry.

You can specify a value from 1 to 12.

This option cannot be defined for the passing information setting job.

`-ri` *retry-interval*

Specify the retry interval for automatic retry.

You can specify a value from 1 to 10 (minutes).

This option cannot be defined for the passing information setting job.

`-qu` *queue-name*

Modifies the name of the queue for queuing the job.

You can specify a character string of 1 to 63 bytes.

`-qm` *queue-manager-host-name*

Modifies the name of the queue manager host.

You can specify a character string of 1 to 255 bytes.

`-rq` *job-name*

Modifies the job name.

You can specify a character string of 1 to 63 bytes.

`-s1` *transfer-source-file-name-1*

Modifies transfer source file name 1.

You can specify a character string of 1 to 511 bytes.

`-d1` *transfer-destination-file-name-1*

Modifies transfer destination file name 1.

You can specify a character string of 1 to 511 bytes.

-t1 {sav|del}

Modifies the option for deleting transfer destination file 1 upon the completion of job execution.

- sav
Saves the file upon the completion of job execution.
- del
Deletes the file upon the completion of job execution.

-s2 *transfer-source-file-name-2*

Modifies transfer source file name 2.

You can specify a character string of 1 to 511 bytes.

-d2 *transfer-destination-file-name-2*

Modifies transfer destination file name 2.

You can specify a character string of 1 to 511 bytes.

-t2 {sav|del}

Modifies the option for deleting transfer destination file 2 upon the completion of job execution.

- sav
Saves the file upon the completion of job execution.
- del
Deletes the file upon the completion of job execution.

-s3 *transfer-source-file-name-3*

Modifies transfer source file name 3.

You can specify a character string of 1 to 511 bytes.

-d3 *transfer-destination-file-name-3*

Modifies transfer destination file name 3.

You can specify a character string of 1 to 511 bytes.

-t3 {sav|del}

Modifies the option for deleting transfer destination file 3 upon the completion of job execution.

- sav
Saves the file upon the completion of job execution.
- del
Deletes the file upon the completion of job execution.

-s4 *transfer-source-file-name-4*

Modifies transfer source file name 4.

You can specify a character string of 1 to 511 bytes.

-d4 *transfer-destination-file-name-4*

Modifies transfer destination file name 4.

You can specify a character string of 1 to 511 bytes.

-t4 {sav|del}

Modifies the option for deleting transfer destination file 4 upon the completion of job execution.

- sav
Saves the file upon the completion of job execution.

- del
Deletes the file upon the completion of job execution.
- jt {q|n}
Modify whether the job has the queuing attribute.
- q
Has the queuing attribute.
 - n
Does not have the queuing attribute.
- da *destination-or-broadcast-agent*
Modifies the destination or broadcast agent.
You can specify a character string of 1 to 128 bytes.
You can specify this option for flexible jobs only. If you specify this option for any other jobs, processing continues on the assumption that the option is invalid.
- fg {none|sync|async}
Modifies the broadcast execution method for a flexible job.
With broadcast execution for a flexible job, you can use either of the two modes (synchronous mode and asynchronous mode) for processing of succeeding jobs. In synchronous mode, a succeeding job is executed after the broadcast agent receives reports of execution completion from all destination agents. In asynchronous mode, a succeeding job is executed when the broadcast agent sends an execution request to all destination agents.
- none
Executes a normal flexible job without performing broadcast execution.
 - SYNC
Performs broadcast execution in synchronous mode.
 - ASYNC
Performs broadcast execution in asynchronous mode.
- HC *connection-configuration-file-name*
Modifies connection configuration file name.
You can specify a character string of 1 to 511 bytes.
Specify the path name by using the absolute path.
- HK {GET|POST|PUT|DELETE}
Modifies the request type.
- GET
 - POST
 - PUT
 - DELETE
- If you specify "", the default value GET is assumed.
- HE {y|n}
Defines whether to use extended mode. You can specify this option if the versions of JP1/AJS3 - Manager and JP1/AJS3 - Agent are 12-50 or later.
If you specify "", the default value n is assumed.
- y

Uses extended mode. The contents of both the transmission information file (URL parameter) and the transmission information file (message body) are sent as an HTTP request.

- *n*

Does not use extended mode. The contents of only the transmission information file are sent as an HTTP request.

If you specify *y* for this option, the definition of the transmission information file name is initialized. In addition, when *y* is specified for this option, if the `-HS` option is specified together with this option, it is ignored.

If you specify *n* for this option, the definition of the transmission information file name (URL parameter) and the transmission information file name (message body) is initialized. In addition, when *n* is specified for this option, if the `-HU` and `-HM` options are specified together with this option, they are ignored.

`-HS` *transmission-information-file-name*

Modifies transmission information file name. You can specify this option if the versions of JP1/AJS3 - Manager and JP1/AJS3 - Agent are 12-10 or earlier, or if extended mode is not used.

You can specify a character string of 1 to 511 bytes.

Specify the path name by using the absolute path.

If you specify "", this item becomes undefined.

If you specify this option together with the `-HE` option, you must specify *n* for the `-HE` option. If *n* (do not use extended mode) has been specified when you run this command, you can omit the `-HE` option. If you omit the `-HE` option when *y* (use extended mode) has been specified, the specification of the `-HS` option is ignored.

`-HU` *transmission-information-file-name-(URL-parameter)*

Modifies the transmission information file name (URL parameter). You can specify this option if extended mode is used when the versions of JP1/AJS3 - Manager and JP1/AJS3 - Agent are 12-50 or later.

You can specify a character string of 1 to 511 bytes.

Specify the path name by using the absolute path.

If you specify "", this item becomes undefined.

If you specify this option together with the `-HE` option, you must specify *y* for the `-HE` option. If *y* (use extended mode) has been specified when you run this command, you can omit the `-HE` option. If you omit the `-HE` option when *n* (do not use extended mode) has been specified, the specification of the `-HU` option is ignored.

`-HM` *transmission-information-file-name-(message-body)*

Modifies the transmission information file name (message body). You can specify this option if extended mode is used when the versions of JP1/AJS3 - Manager and JP1/AJS3 - Agent are 12-50 or later.

You can specify a character string of 1 to 511 bytes.

Specify the path name by using the absolute path.

If you specify "", this item becomes undefined.

If you specify this option together with the `-HE` option, you must specify *y* for the `-HE` option. If *y* (use extended mode) has been specified when you run this command, you can omit the `-HE` option. If you omit the `-HE` option when *n* (do not use extended mode) has been specified, the specification of the `-HM` option is ignored.

`-HT` *statuses-store-file-name*

Modifies statuses store file name.

You can specify a character string of 1 to 511 bytes.

Specify the path name by using the absolute path.

`-HD` {*diff*|*same*}

Modifies how received data is stored.

- *diff*

The header part of the received data is written to the file for storing the received header, and the body part is written to the file for storing the received body.

- same

The header part and body part of the received data are written to the file for storing the received header, without being separated.

If you specify "", the default value `diff` is assumed.

If you specify `same`, the value specified for `-HB name-of-the-file-for-storing-received-body` is ignored.

`-HH received-header-store-file-name`

Modifies received header store file name.

You can specify a character string of 1 to 511 bytes.

Specify the path name by using the absolute path.

`-HB received-body-store-file-name`

Modifies received body store file name.

You can specify a character string of 1 to 511 bytes.

Specify the path name by using the absolute path.

If you specify `same` for the `-HD {diff|same}` option, the setting for this option is ignored.

`-HR return-code-1:HTTP-status-code-1 [, HTTP-status-code-2 . . .] ;`

Specifies a job return code for each HTTP status code.

You can specify multiple instances of this option. To specify multiple job return codes, use the following specification format: `-HR return-code-1:HTTP-status-code-1 -HR return-code-2:HTTP-status-code-2 ...`

You can specify a character string of 1 to 511 bytes. For a job return code, you can specify a value in the range from 0 to 9. For an HTTP status code, you can specify a value in the range from 100 to 999. You can use only numeric characters (0 to 9) and colons (:).

If you specify "", this item becomes undefined.

judgment-job-information-change-options

These options modify definition information for a judgment job.

`-ej {gt|ge|lt|le|eq|ne|ri|ro|ef|nf|vgt|vge|vlt|vle|veq|vne|vri|vro|sce|spe|sne|spn|snn|snl}`

This option is used to modify the judgment method.

- `gt`
Indicates that the return code for the preceding job is greater than the judgment value.
- `ge`
Indicates that the return code for the preceding job is greater than or equal to the judgment value.
- `lt`
Indicates that the return code for the preceding job is less than the judgment value.
- `le`
Indicates that the return code for the preceding job is less than or equal to the judgment value.
- `eq`
Indicates that the return code for the preceding job is equal to the judgment value.
- `ne`
Indicates that the return code for the preceding job is not equal to the judgment value.

- `ri`
Indicates that the return code of the preceding job is within the judgment value range. The lower limit judgment return code (`-el` option) and the upper limit judgment return code (`-eh` option) must also be specified at the same time. If necessary, specify boundary conditions (the `-lP` and `-uP` options).
- `ro`
Indicates that the return code of the preceding job is outside of the judgment value range. The lower limit judgment return code (`-el` option) and the upper limit judgment return code (`-eh` option) must also be specified at the same time. If necessary, specify boundary conditions (the `-lP` and `-uP` options).
- `ef`
Indicates that the job has created a file.
- `nf`
Indicates that the job has not created a file.
- `vgt`
Indicates that the value of the specified variable is greater than the judgment value (numeric).
- `vge`
Indicates that the value of the specified variable is equal to or greater than the judgment value (numeric).
- `vlt`
Indicates that the value of the specified variable is less than the judgment value (numeric).
- `vle`
Indicates that the value of the specified variable is equal to or less than the judgment value (numeric).
- `veq`
Indicates that the value of the specified variable is equal to the judgment value (numeric).
- `vne`
Indicates that the value of the specified variable is not equal to the judgment value (numeric).
- `vri`
Indicates that the value of the specified variable is within the judgment value (numeric) range. The lower limit variable judgment value (`-jS` option) and the upper limit variable judgment value (`-jG` option) must also be specified at the same time. If necessary, specify boundary conditions (the `-lP` and `-uP` options).
- `vro`
Indicates that the value of the specified variable is outside the judgment value (numeric) range. The lower limit variable judgment value (`-jS` option) and the upper limit variable judgment value (`-jG` option) must also be specified at the same time. If necessary, specify boundary conditions (the `-lP` and `-uP` options).
- `sce`
Indicates that the value of the specified variable is equal to the judgment value (string).
- `spe`
Indicates that the value of the specified variable includes the judgment value (string).
- `sne`
Indicates that the value of the specified variable is not equal to the judgment value (string).
- `spn`
Indicates that the value of the specified variable does not include the judgment value (character string). The variable name (`-jV` option) and the judgment character string (`-jT` option) of the variable must also be specified at the same time.

- `snn`
Indicates that the value of the specified variable does exist.
- `snl`
Indicates that the value of the specified variable does not exist.

`-ec judgment-return-code`

Modifies the return code used for judgment.

You can specify a value between 0 and 4,294,967,295.

`-el lower-limit-judgment-return-code`

Changes the lower limit return code used for judgment.

You can specify a value from 0 to 4,294,967,295. If there is no integer value within the range used to judge the return code from the lower limit judgment return code (`-el` option) and the boundary condition (`-lP` option) to the upper limit judgment code (`-eh` option) and the boundary condition (`-uP` option), an error occurs.

If the return code is either within or outside the judgment value range (the `vi` or `ro` is specified for the `-ej` option), this option takes effect.

If the return code is a negative value, judgment can be performed by specifying a value that is converted to an unsigned integer. For example, `-1` is handled as 4,294,967,295 in Windows, and as 255 in UNIX. Note, however, that if a negative number in a return code is converted to an unsigned integer, it is within the range from 2,147,483,648 to 4,294,967,295. Therefore, if the range for a return code is spans 0, a range cannot be specified.

`-eh upper-limit-judgment-return-code`

Changes the upper limit return code used for judgment.

You can specify a value from 0 to 4,294,967,295. If there is no integer value within the range used to judge the return code from the lower limit judgment return code (`-el` option) and the boundary condition (`-lP` option) to the upper limit judgment code (`-eh` option) and the boundary condition (`-uP` option), an error occurs.

If the return code is either within or outside the judgment value range (the `vi` or `ro` is specified for the `-ej` option), this option takes effect.

If the return code is a negative value, judgment can be performed by specifying a value that is converted to an unsigned integer. For example, `-1` is handled as 4,294,967,295 in Windows, and as 255 in UNIX. Note, however, that if a negative number in a return code is converted to an unsigned integer, it is within the range from 2,147,483,648 to 4,294,967,295. Therefore, if the range for a return code is spans 0, a range cannot be specified.

`-ef end-judgment-file-name`

Modifies the name of the file used for judgment.

You can specify a character string of 1 to 260 bytes.

`-jV variable-name`

Changes the variable name serving as the target of judgment.

You can specify a string of 1 to 64 bytes in `?AJS2xxxx?` format. What you can specify in the `xxxxx` part is limited to upper-case alphabetic characters, numeric characters, and periods (`.`).

`-jT string-of-judging-variable`

Changes the string serving as the target of variable judgment.

You can specify a string of 1 to 511 bytes.

`-jI numerical-value-of-judging-variable`

Changes the numerical value serving as the target of variable judgment.

You can specify a value of 0 to 2,147,483,647.

`-jS lower-limit-variable-judgment-value`

Changes the numeric value of the lower limit used for variable judgment.

You can specify a value from 0 to 2,147,483,647. If there is no integer value within the range used for variable judgment (numeric) from the lower limit variable judgment numeric value (`-jS` option) and the boundary condition (`-lP` option) to the upper limit variable judgment numeric value (`-jG` option) and the boundary condition (`-uP` option), an error occurs.

If the variable value is either within or outside the range (the `vri` or `vro` is specified for the `-ej` option) of the judgment value (numeric), this option takes effect.

`-jG` *upper-limit-variable-judgment-value*

Changes the numeric value of the upper limit used for variable judgment.

You can specify a value from 0 to 2,147,483,647. If there is no integer value within the range used for variable judgment (numeric) from the lower limit variable judgment numeric value (`-jS` option) and the boundary condition (`-lP` option) to the upper limit variable judgment numeric value (`-jG` option) and the boundary condition (`-uP` option), an error occurs.

If the variable value is either within or outside the range (the `vri` or `vro` is specified for the `-ej` option) of the judgment value (numeric), this option takes effect.

`-lP` {`gt`|`ge`}

Defines boundary conditions for the lower limit judgment return code (`-e1` option) or the lower limit variable judgment value (`-jS` option).

- `gt`
Indicates that the return code of the preceding job or the judgment value (numeric) of a variable is greater than the judgment value.
- `ge`
Indicates that the return code of the preceding job or the judgment value (numeric) of a variable is equal to or greater than the judgment value.

`-uP` {`lt`|`le`}

Defines boundary conditions for the upper limit judgment return code (`-eh` option) or the upper limit variable judgment value (`-jG` option).

- `lt`
Indicates that the return code of the preceding job or the judgment value (numeric) of a variable is smaller than the judgment value.
- `le`
Indicates that the return code of the preceding job or the judgment value (numeric) of a variable is equal to or smaller than the judgment value.

JP1-event-reception-monitoring-job-information-change-options

These options modify definition information for a JP1 event reception monitoring job.

`-jp` *macro-variable-specification*

Modifies the specification of a macro variable.

You can specify this option multiple times in the format `-jp macro-variable-name:passing-information-name`. However, if you specify the same macro variable name more than once, the system only passes the passing information associated with the first instance of the macro variable name.

Specify macro variable names as a string of 1 to 64 bytes in `?AJS2xxxx?` format. The `xxxxx` part is limited to upper-case alphabetic characters, numeric characters, and periods (`.`).

You can specify a character string of up to 2,048 bytes in total. This means that the sum of the number of bytes should not exceed 2,048 after the value of the `-jp` option is converted to the `jpouif=?AJS2xxxx?:passing-information-name`; format that is output with the `ajsprint -a` option.

You can specify the following character strings for *passing-information-name*:

- CMTMOUT: Whether the job has ended due to time-out
- EVID: Event ID
- EVUSR: Event issuer user name
- EVGRP: Event issuer group name
- EVHOST: Event issuer event server name
- EVIPADDR: Event issuer IP address
- EVMSG: Message information
- EVDETAIL: Event detail information
- EVSEV: Extended attribute event level
- EV: *extended-attribute-name*: Arbitrary extended attribute
- EVENV1 to EVENV9: Retrieved data
- EVUSRID: Event issuer user ID
- EVGRPID: Event issuer group ID
- EVPROCESSID: Event issuer process ID
- EVDATE: Date of event issue
- EVTIME: Time of event issue

-EI *monitoring-event-ID*

Modifies the monitoring event ID.

You can specify a hexadecimal value between 00000000:00000000 and FFFFFFFF:FFFFFFF.

-EU *event-source-user-name*

Modifies the name of the user issuing an event.

You can specify a character string of 1 to 20 bytes.

-EG *event-source-group-name*

Modifies the name of the group issuing an event.

You can specify a character string of 1 to 20 bytes.

-EH *event-source-host-name*

Modifies the name of the host issuing an event.

You can specify a character string of 1 to 255 bytes.

-Ei *event-source-IP-address*

Modifies the IP address of the event source.

You can specify a value between 0.0.0.0 and 255.255.255.255 in the *XXX.YYY.xxx.yyy* format. You can specify a value between 0 and 255 for each of *XXX*, *YYY*, *xxx* and *yyy*.

-EM *event-message-information*

Modifies the event message information.

You can specify characters or a regular expression of 1 to 1,024 bytes.

-ED *event-detail-information*

Modifies the event detail information.

You can specify characters or a regular expression of 1 to 1,024 bytes.

-ES *event-level*

Modifies the event level, which is one of the event extended attributes.

You can specify the following character strings. You can specify multiple event levels delimited with ":", such as

`-ES em:al.`

- `em`: Uses Emergency as the matching criteria.
- `al`: Uses Alert as the matching criteria.
- `cr`: Uses Critical as the matching criteria.
- `er`: Uses Error as the matching criteria.
- `wr`: Uses Warning as the matching criteria.
- `no`: Uses Notice as the matching criteria.
- `in`: Uses Information as the matching criteria.
- `db`: Uses Debug as the matching criteria.

-EF *any-event-extended-attribute*

Modifies any event extended attribute.

You can specify more than one attribute in the following format:

`-EF "any-event-extended-attribute-name : \"value\""`

If the value contains double quotation marks (") or #, use a cast character (#). Specify #\" for " and ## for #.

You can specify a character string of up to 2,048 bytes in total. This means that the sum of the number of bytes should not exceed 2,048 after the value specified in the `-EF` option is converted to the `evwfr=any-event-extended-attribute-name : "value"`; format that is output with the `ajspint -a` option.

-ET *end-judgment-condition*

Modifies the end judgment condition.

You can specify the following characters:

- `n`: Assumes every termination of the job to be a normal end.
- `a`: Assumes every termination of the job to be an abnormal end.
- `n:file-name`: Assumes a normal end if the message coincides with the contents of the specified file.
- `a:file-name`: Assumes an abnormal end if the message coincides with the contents of the specified file.
- `d:file-name`: Assumes a normal end if the detailed information coincides with the contents of the specified file.
- `b:file-name`: Assumes an abnormal end if the detailed information coincides with the contents of the specified file.

You can specify a character string of 1 to 256 bytes for the file name.

-Eu *event-source-user-ID*

Modifies the ID of the user issuing an event.

You can specify a value between -1 to 9,999,999,999.

-Eg *event-source-group-ID*

Modifies the ID of the group issuing an event.

You can specify a value between -1 to 9,999,999,999.

-Ep *event-source-process-ID*

Modifies the ID of the process issuing an event.

You can specify a value between -1 to 9,999,999,999.

-Ee {no|minutes}

Specify whether, immediately after the JP1 event reception monitoring job is executed (before starting monitoring for a JP1 event) any previous JP1 events will still be monitored for reception.

- no

Does not search for previous JP1 events.

- minutes

Searches for JP1 events that occurred after the specified time before the JP1 event reception monitoring job was executed. You can specify a decimal value between 1 and 720 (minutes).

If you specify *minutes*, ensure that the monitor event ID is already specified with the -EI option.

If you have not specified the monitor event ID, use the -EI option simultaneously to specify the monitor event ID.

file-monitoring-job-information-change-options

These options modify definition information for a file monitoring job.

-jp *macro-variable-specification*

Modifies the specification of a macro variable.

You can specify this option multiple times in the format -jp *macro-variable-name*:*passing-information-name*. However, if you specify the same macro variable name more than once, the system only passes the passing information associated with the first instance of the macro variable name.

Specify macro variable names as a string of 1 to 64 bytes in ?AJS2xxxx? format. The xxxxx part is limited to upper-case alphabetic characters, numeric characters, and periods (.).

You can specify a character string of up to 2,048 bytes in total. This means that the sum of the number of bytes should not exceed 2,048 after the value of the -jp option is converted to the jpoif=?AJS2xxxx?:*passing-information-name*; format that is output with the `ajsprint -a` option.

You can specify the following character strings for *passing-information-name*:

- CMTMOUT: Whether the job has ended due to time-out
- FLFILENAME: Full-path name of the changed file
- FLCOND: Conditional parameter
- FLCTIME: Time at which the file was updated
- FLSIZE: Size of the changed file

-FF *monitored-file-name*

Modifies the name of the file to be monitored.

You can specify a character string of 1 to 255 bytes. Use a complete name or wildcard characters to specify the file name. Note, however, that you cannot specify the file name using wildcard characters when a value from 1 to 9 is used to specify the monitor interval in the -FI option.

-FC *monitoring-conditions*

Modifies the monitoring conditions.

You can specify one or more of the following characters. (Delimit with ":", such as -FC c:d. You cannot, however, specify both s and m in one command.

- c: Monitors the creation of a file.
- d: Monitors the deletion of a file.
- s: Monitors the resizing of a file.
- m: Monitors the modification of the last written time for a file.

When you specify the `-FO` option, also specify the `c` character.

If you specify the `c` character without specifying the `-FO` option, the file monitor job is executed before the system monitors creation of the file to be monitored.

If you delete the `c` character, the system does not monitor file creation.

`-FI` *monitoring-interval*

Modifies the time interval for file monitoring.

You can specify a value between 1 and 600 (seconds). Note, however, that you cannot specify a value from 1 to 9 when the file name using wildcard characters is used to specify the monitor file name in the `-FF` option.

`-FO` *handling-in-presence-of-file-to-be-monitored*

This option changes the way of executing the file monitoring job when there is a file to be monitored. It can be specified only when the monitor conditions contain "Monitor file creation".

You can specify one or more of the following characters.

- `y`: The system terminates normally assuming that the monitor conditions have been met.
- `n`: The system continues to monitor the target file.

email-reception-monitoring-job-information-change-options

These options modify definition information for an email reception monitoring job.

`-jP` *macro-variable-specification*

Modifies the specification of a macro variable.

You can specify this option multiple times in the format `-jP macro-variable-name:passing-information-name`. However, if you specify the same macro variable name more than once, the system only passes the passing information associated with the first instance of the macro variable name.

Specify macro variable names as a string of 1 to 64 bytes in `?AJS2xxxx?` format. The `xxxxx` part is limited to upper-case alphabetic characters, numeric characters, and periods (`.`).

You can specify a character string of up to 2,048 bytes in total. This means that the sum of the number of bytes should not exceed 2,048 after the value of the `-jP` option is converted to the `jPoiF=?AJS2xxxx?:passing-information-name`; format that is output with the `ajsprint -a` option.

You can specify the following character strings for *passing-information-name*:

- `CMTMOUT`: Whether the job has ended due to time-out
- `MLRCVADDRESS`: Email sender's address[#]
- `MLRCVSUBJECT`: Email title
- `MLRCVBODY`: File storing email text
- `MLRCVATTACHFILE nn` (nn is a value between 01 and 20): Name of the file attached to the email
- `MLRCVATTACHLIST`: Name of the file containing a list of files attached to the email
- `MLRCVMAILBODY`: Email
- `MLRCVTIME`: Time at which the email arrived

#

In Windows, you can pass display names (nicknames).

To pass a display name, set the `Nickname` attribute of the `NextAddress` environment setting parameter. For details, see *2.3.4 Setting up the environment for the mail system linkage* in the *JPI/Automatic Job Management System 3 Linkage Guide*.

-pf *platform-type*

Modifies the platform type for defining email reception.

You can specify either of the following characters:

- u: Defines email reception under UNIX.
- p: Defines email reception under Windows.

-MA *sender*

Modifies the sender of the received email.

You can specify a character string of 1 to 256 bytes.

You can specify up to 20 senders in the -MA "*sender*" format.

-ML *email-reception-list-name*

Modifies the name of the email reception list.

You can specify a character string of 1 to 255 bytes.

-MP *profile-name*

Modifies the profile name.

You can specify a character string of 1 to 256 bytes.

-Ms *email-save-mode*

Modifies the mode of saving received email.

You can specify either of the following characters:

- y: Saves received email.
- n: Does not save received email.

-MS *subject*

Modifies the subject of the received email.

You can specify a character string of 1 to 256 bytes.

You can specify up to 20 subjects in one command using the -MS "*subject*" format.

-MF *folder-to-store-attached-file*

Modifies the name of the folder in which you store any attached file of the received email.

You can specify a character string of 1 to 256 bytes.

-mf *attached-file-list-file-name*

Modifies the name of the file containing a list of attached files.

You can specify a character string of 1 to 256 bytes. Use a full path to specify the list file name.

-Mt *file-to-store-email-text*

Modifies the name of the file in which you store the text of the received email.

You can specify a character string of 1 to 256 bytes. Use a full path to specify the file name.

-MT *text*

Modifies the text of the received email.

You can specify a character string of 1 to 512 bytes.

You can specify up to 20 messages in one command in the -MT *text* format.

message-queue-reception-monitoring-job-information-change-options

These options modify definition information for a message queue reception monitoring job.

-jp macro-variable-specification

Modifies the specification of a macro variable.

You can specify this option multiple times in the format *-jp macro-variable-name : passing-information-name*. However, if you specify the same macro variable name more than once, the system only passes the passing information associated with the first instance of the macro variable name.

Specify macro variable names as a string of 1 to 64 bytes in *?AJS2xxxx?* format. The *xxxxx* part is limited to upper-case alphabetic characters, numeric characters, and periods (.).

You can specify a character string of up to 2,048 bytes in total. This means that the sum of the number of bytes should not exceed 2,048 after the value of the *-jp* option is converted to the *jpouif=?AJS2xxxx? : passing-information-name;* format that is output with the *ajsprint -a* option.

You can specify the following character strings for *passing-information-name*:

- **CMTMOUT**: Whether the job has ended due to time-out
- **MQRCVCORRELATION**: Message correlation ID
- **MQRCVDISCRIMINATION**: Message ID
- **MQRCVQUEUE**: Message reception queue name
- **MQRCVMODELQUEUE**: Model queue name
- **MQRCVMESSAGEFILE**: Message structure storage file name

-QC correlation-ID

Modifies the correlation ID of the received message.

You can specify a character string of 1 to 24 bytes. You can, however, specify only uppercase letters and numbers.

-QD message-ID

Modifies the message ID of the received message.

You can specify a character string of 1 to 24 bytes. You can, however, specify only uppercase letters and numbers.

-QM model-queue-name

Modifies the model queue name for the queue used to monitor message reception.

You can specify a character string of 1 to 48 bytes. Specify the queue name using an MQ character string.

-QQ message-reception-queue-name

Modifies the name of the queue used to monitor message reception.

You can specify a character string of 1 to 48 bytes. Specify the queue name using an MQ character string.

-QS message-storage-file-name

Modifies the name of the file in which you store messages.

You can specify a character string of 1 to 256 bytes.

MSMQ-reception-monitoring-job-information-change-options

These options modify definition information for an MSMQ reception monitoring job.

-jp macro-variable-specification

Modifies the specification of a macro variable.

You can specify this option multiple times in the format *-jp macro-variable-name : passing-information-name*. However, if you specify the same macro variable name more than once, the system only passes the passing information associated with the first instance of the macro variable name.

Specify macro variable names as a string of 1 to 64 bytes in *?AJS2xxxx?* format. The *xxxxx* part is limited to upper-case alphabetic characters, numeric characters, and periods (.).

You can specify a character string of up to 2,048 bytes in total. This means that the sum of the number of bytes should not exceed 2,048 after the value of the `-jp` option is converted to the `jpouif=?AJS2xxxx?:passing-information-name`; format that is output with the `ajsprint -a` option.

You can specify the following character strings for *passing-information-name*:

- CMTMOUT: Whether the job has ended due to time-out
- MSRCVQUEUEPATH: Message queue path name
- MSRCVMUTUAL: Message correlation ID
- MSRCVMESSELABEL: Message label
- MSRCVAPPLICATION: Message application information
- MSRCVMESSELFILE: Message structure storage file name

`-SA` *application-information*

Modifies the application information for the message to be monitored.

You can specify a hexadecimal value between 0 and FFFFFFFF.

`-SM` *message-label*

Modifies the message label for the message to be monitored.

You can specify a character string of 1 to 249 bytes.

`-SQ` *queue-path-name*

Modifies the queue path name for the queue used to monitor messages.

You can specify a character string of 1 to 259 bytes.

`-SR` *message-correlation-ID*

Modifies the correlation ID of the message to be monitored.

You can specify a character string of 1 to 20 bytes. You can, however, specify only uppercase letters and numbers.

`-SF` *message-storage-file-name*

Modifies the name of the file in which you store messages.

You can specify a character string of 1 to 256 bytes. Use a full path to specify the file name.

log-file-monitoring-job-information-change-options

These options modify definition information for a log file monitoring job.

`-jp` *macro-variable-specification*

Modifies the specification of a macro variable.

You can specify this option multiple times in the format `-jp macro-variable-name : passing-information-name`.

However, if you specify the same macro variable name more than once, the system only passes the passing information associated with the first instance of the macro variable name.

Specify macro variable names as a string of 1 to 64 bytes in `?AJS2xxxx?` format. The `xxxxx` part is limited to upper-case alphabetic characters, numeric characters, and periods (.).

You can specify a character string of up to 2,048 bytes in total. This means that the sum of the number of bytes should not exceed 2,048 after the value of the `-jp` option is converted to the `jpouif=?AJS2xxxx?:passing-information-name`; format that is output with the `ajsprint -a` option.

You can specify the following character strings for *passing-information-name*:

- CMTMOUT: Whether the job has ended due to time-out
- LFFNAME: Trapped log file name
- LFDATA: Trapped data

-Lw *file-creation-wait-option*

Modifies the option for file creation wait at the beginning of log file monitoring job.

You can specify either of the following characters:

- y: Generates an error if a log file is not found.
- n: Repeats opening a file until a log file is created.

-Ld *log-file-output-file-format*

Modifies the output file format for the log file.

You can specify the following character strings.

- s: Sequential (default). Data is appended to one log file, and when the file is filled to its capacity, a new log file is created with another name, and new log data is written to the new file.
- s2: Sequential. A log file with the same name is continuously used for logging by creating a new file with the same name after backing up the current file with another name or deleting the current file.

If the job execution host is a Windows host, you can specify this option in JP1/AJS3 or in JP1/AJS2 08-00 or a later version if the JP1/Base version is 08-10 or later.

If the job execution host is a UNIX host, you can specify this option in JP1/AJS3 or in JP1/AJS2 07-00 or a later version if the JP1/Base version is 07-00 or later.

- w1: Wraparound (When log data is written to the end of the log file, the existing data is overwritten with new data, starting with the beginning of the file.)
- w2: Wraparound (When log data is written to the end of the log file, the existing data is deleted and then new data is written from the beginning of the file.)

-LF *log-file-name*

Changes the log file name to be monitored.

You can specify a character string of 1 to 256 bytes.

You can specify up to 8 files in one command in the -LF "*log-file-name*" format.

-LL *header-specification*

Modifies the header.

You can specify either of the following characters:

- l : *number-of-lines-in-header*: Modifies the number of lines contained in the header. You can specify a value between 0 and 99,999 (lines).
- s : *header-size*: Modifies the size of the header. You can specify a size of up to 9,999,999 (bytes).

-LM *data-other-than-log-information*

Modifies data other than the log information.

You can specify more than one data item in one command using the -LM "[!]" "*data-other-than-log-information*" format.

If the data contains double quotation marks (") or #, use a cast character (#). Specify #\" for " and ## for #.

You can specify a character string of up to 1,024 bytes in total. This means that the sum of the number of bytes should not exceed 1,024 after the value specified in the -LM option is converted to the following format that is output with the `ajspint -a` option:

```
lfmks=[!]"data-1-other-than-log-information"[:[!]"data-2-other-than-log-information"....];
```

-LX *maximum-event-data-length*

Modifies the maximum length of event data.

You can specify a character string of 2 to 512 bytes.

-LR *log-data-record-format*

Modifies the record format of the log data to be trapped.

You can specify either of the following characters:

- *v*: '[\] *delimiter*': Delimits a line using variable-length records. You can specify the delimiter consisting of a character string of 1 byte.
- *f*: *record-length*: Delimits a line using fixed-length records. You can specify a value between 1 and 9,999,999 (bytes) for the record length.

-LI *log-file-search-interval*

Modifies the time interval for log file searching.

You can specify a value between 1 and 86,400 (seconds).

-LS *search-start-option*

Modifies the search start option.

You can specify either of the following characters:

- *y*: Inputs from the top data.
- *n*: Does not input from the top data.

-LD *trap-data*

Modifies the data to be trapped.

You can specify more than one data item in one command using the `-LD "[!]"trap-data\` format.

If the trap data contains double quotation marks (") or #, use a cast character (#). Specify #\" for " and ## for #.

You can specify a character string of up to 2,048 bytes in total. This means that the sum of the number of bytes should not exceed 2,048 after the value specified in the `-LD` option is converted to the `lftpd=[!]"trap-data-1"[:[!]"trap-data-2" . . .] ;` format that is output with the `ajsprint -a` option.

Windows-event-log-monitoring-job-information-change-options

These options modify definition information for a Windows event log monitoring job.

-jp *macro-variable-specification*

Modifies the specification of a macro variable.

You can specify this option multiple times in the format `-jp macro-variable-name:passing-information-name`. However, if you specify the same macro variable name more than once, the system only passes the passing information associated with the first instance of the macro variable name.

Specify macro variable names as a string of 1 to 64 bytes in `?AJS2xxxx?` format. The `xxxxx` part is limited to upper-case alphabetic characters, numeric characters, and periods (.).

You can specify a character string of up to 2,048 bytes in total. This means that the sum of the number of bytes should not exceed 2,048 after the value of the `-jp` option is converted to the `jpouif=?AJS2xxxx?:passing-information-name;` format that is output with the `ajsprint -a` option.

You can specify the following character strings for *passing-information-name*:

- **CMTMOUT**: Whether the job has ended due to time-out
- **NELOG**: Log type
- **NEEVKIND**: Event type
- **NESOURCE**: Source
- **NECLASS**: Category
- **NEEVID**: Event ID

- NEDETAIL: Description
- NJ *event-category-judgment-condition*
 Modifies the judgment condition for an event category.
 You can specify one of the following characters:
- y: Monitors the specified category.
 - n: Monitors the categories other than the specified category.
- NC *category*
 Modifies the category of the events you want to monitor.
 You can specify a character string of 1 to 255 bytes.
- ND *description*
 Modifies the description you want to use for comparison when monitoring the detailed description of an event.
 You can specify a character string of 1 to 1,024 bytes.
- Ni *event-ID-judgment-condition*
 Modifies the judgment condition for an event ID.
 You can specify either of the following characters:
- y: Monitors the specified event ID.
 - n: Monitors the event IDs other than the specified event ID.
- NI *event-ID*
 Modifies the event ID of the events you want to monitor.
 You can specify a value between 0 and 4,294,967,295.
- NE *event-type*
 Modifies the event type.
 You can specify either of the following characters: You can specify one of the following characters: You can specify multiple types delimited with ":", such as -NE i:w:e.
- v: Monitors verbose events.
 - i: Monitors information events.
 - w: Monitors warning events.
 - e: Monitors error events.
 - c: Monitors critical events.
 - s: Monitors successful audit events.
 - f: Monitors failed audit events.
- NL *log-type*
 Modifies the log type.
 You can specify the following character strings.
- sys: Monitors the system log.
 - sec: Monitors the security log.
 - app: Monitors the application log.
 - dns: Monitors the DNS Server log (for Windows 2000).
 - dir: Monitors the Directory Service log (for Windows 2000).

- `frs`: Monitors the file reproduction service log (for Windows 2000).
- `oth`: Monitors the log type specified for the `-Nt` option.

When `oth` is specified, the `-Nt` option must also be specified. If the value is changed from `oth` to another value, the value specified for the `-Nt` option is deleted.

`-Nt any-log-type`

Changes an arbitrary log type to be monitored.

You can specify a character string of 1 to 255 bytes.

If `oth` is not specified for the `-NL` option, an error occurs.

`-Ns source-judgment-condition`

Modifies the judgment condition for a source.

You can specify either of the following characters:

- `y`: Monitors the specified source.
- `n`: Monitors the sources other than the specified source.

`-NS source`

Modifies the source you want to monitor.

You can specify a character string of 1 to 255 bytes.

execution-interval-control-job-information-change-options

This option modifies definition information for an execution interval control job.

`-jp macro-variable-specification`

Modifies the specification of a macro variable.

You can specify this option multiple times in the format `-jp macro-variable-name:passing-information-name`. However, if you specify the same macro variable name more than once, the system only passes the passing information associated with the first instance of the macro variable name.

Specify macro variable names as a string of 1 to 64 bytes in `?AJS2xxxx?` format. The `xxxxx` part is limited to upper-case alphabetic characters, numeric characters, and periods (`.`).

You can specify a character string of up to 2,048 bytes in total. This means that the sum of the number of bytes should not exceed 2,048 after the value of the `-jp` option is converted to the `jpouif=?AJS2xxxx?:passing-information-name;` format that is output with the `ajspint -a` option.

You can specify the following character strings for *passing-information-name*:

- `CMTMOUT`: Whether the job has ended due to time-out

`-Tw wait-time`

Modifies the wait time.

You can specify a value between 1 and 1,440 for the minute.

`-eT {y|n}`

When the execution interval control job is defined as a start condition, specify whether to complete the job immediately after it is started:

- `y`: Completes the job immediately after it is started and starts the first execution immediately.
- `n`: The job is not completed immediately after it is started. The job waits until the wait time passes before it starts the first execution.

For the execution interval control job defined for a normal jobnet instead of a start condition, the `-eT` option cannot be specified. If the option is specified, the KAVS0159-W message appears, the specification of the option is treated as invalid, and command processing continues.

JP1-event-sending-job-information-change-options

These options modify definition information for an JP1 event sending job.

`-pf platform-type`

Modifies the platform type.

You can specify either of the following characters:

- `u`: Operates in a UNIX environment.
- `p`: Operates in a Windows environment.

`-EH event-destination-host-name`

Modifies the name of the host to which you want to transmit events.

You can specify a character string of 1 to 255 bytes.

`-eM message`

Modifies the message information you want to attach to the event.

You can specify a character string of 1 to 1,023 bytes.

`-eI transmit-event-ID`

Modifies the event ID of the event you want to transmit.

You can specify a hexadecimal value between 00000000 and 00001FFF, or between 7FFF8000 and 7FFFFFFF.

`-eS event-level`

Modifies the event level, which is one of the event extended attributes.

You can specify the following character strings.

- `em`: Specifies Emergency.
- `al`: Specifies Alert.
- `cr`: Specifies Critical.
- `er`: Specifies Error.
- `wr`: Specifies Warning.
- `no`: Specifies Notice.
- `in`: Specifies Information.
- `db`: Specifies Debug.

`-Ef any-event-extended-attribute`

Modifies any extended attribute attached to the event.

You can specify options in the following format: `-Ef "any-extended-attribute-name:\ "value\""`.

You can specify in the following format:

`-Ef "any-event-extended-attribute-name:\ "value\""`

You can specify more than one attribute (up to 128 bytes in the `evsfr=any-event-extended-attribute-name:"value";` format).

If the value contains double quotation marks (") or #, use a cast character (#). Specify `#\"` for " and `##` for #.

-eK {y|n}

Specifies whether to check the arrival of the event.

You can specify either of the following characters:

- n: Does not check the arrival of the event.
- y: Checks the arrival of the event.

-eP *event-arrival-check-interval*

Specifies the interval at which arrival checks will be attempted if the JP1 event has not yet arrived.

If the unit definition specifies no event arrival check, you can modify the specification to check arrivals by specifying this option with the -eK y option.

You cannot specify this option with the -eK n option.

You can specify a decimal value between 3 and 600 (seconds).

-eR *event-arrival-check-count*

Specifies the number of times arrival checks will be attempted if the JP1 event has not yet arrived.

If the unit definition specifies no event arrival check, you can modify the specification to check arrivals by specifying this option with the -eK y option.

You cannot specify this option with the -eK n option.

You can specify a decimal value between 0 and 999 (times).

-jt {q|n}

Changes the queuing attribute type.

- q: The queuing attribute exists.
- n: The queuing attribute does not exist.

email-sending-job-information-change-options

These options modify definition information for an email sending job.

-pf *platform-type*

Modifies the platform type.

You can specify either of the following characters:

- u: Operates in a UNIX environment.
- p: Operates in a Windows environment.

-MA *email-address*

Modifies the address to which you want to transmit email.

You can specify the following character strings.

- to:*email-address*: Transmits the email to the destination.
- cc:*email-address*: Transmits a copy of the email to the destination.
- bcc:*email-address*: Transmits a copy of the email to the destination using the blind carbon copy feature.

You can specify a character string of 1 to 256 bytes for the email address.

You can specify up to 20 email addresses in one command using the -MA "*email-address*" format.

-MP *profile-name*

Modifies the profile name.

You can specify a character string of 1 to 256 bytes.

-MS *subject*

Modifies the subject of the email to be sent.

You can specify a character string of 1 to 256 bytes.

-mF *attached-file-name*

Modifies the name of the file you want to attach to the email to be sent.

You can specify a character string of 1 to 256 bytes. You can specify up to 20 files in one command in the -mF "*attached-file-name*" format. Use a full path to specify the file name.

-mF *attached-file-list-file-name*

Modifies the name of the file containing a list of attached files.

You can specify a character string of 1 to 256 bytes. Use a full path to specify the list file name.

-MT *text*

Modifies the text of the email to be sent.

You can specify a character string of 1 to 512 bytes.

-mt *text-file-name*

Modifies the text file name for the email to be sent.

You can specify a character string of 1 to 256 bytes. Use a full path to specify the file name.

-jt {q|n}

Changes the queuing attribute type.

- q: The queuing attribute exists.
- n: The queuing attribute does not exist.

message-queue-sending-job-information-change-options

These options modify definition information for a message queue for a sending job.

-pF *platform-type*

Modifies the platform type.

You can specify either of the following characters:

- u: Operates in a UNIX environment.
- p: Operates in a Windows environment.

-QC *correlation-ID*

Modifies the correlation ID of the message to be sent.

You can specify a character string of 1 to 24 bytes. You can, however, specify only uppercase letters and numbers.

-QD *message-ID*

Modifies the message ID you want to assign to the message to be sent.

You can specify a character string of 1 to 24 bytes. You can, however, specify only uppercase letters and numbers.

-qE *dead-letter-queue-name*

Modifies the dead letter queue name.

You can specify a character string of 1 to 48 bytes. Specify the queue name using an MQ character string.

-qH *hold-time*

Modifies the hold time for the message to be sent.

You can specify a value between 1 and 9,999,999 for the minute.

-QM *model-queue-name*

Modifies the model queue name.

You can specify a character string of 1 to 48 bytes. Specify the queue name using an MQ character string.

-qD *message-data-file-name*

Modifies the name of the message data file.

You can specify a character string of 1 to 256 bytes.

-qF *message-format-name*

Modifies the message format name.

You can specify a character string of 1 to 8 bytes. You can, however, specify only uppercase letters and numbers.

-qM *queue-manager-name*

Modifies the name of the queue manager used to send the message.

You can specify a character string of 1 to 48 bytes. Specify the queue manager name using an MQ character string.

-qP *connection-queue-management-program-name*

Modifies the name of the connection queue management program.

You can specify a character string of 1 to 48 bytes. Specify the program name using an MQ character string.

-qR *priority*

Modifies the priority of the message to be sent.

You can specify a value between 0 and 9.

-qP *permanence*

Modifies the permanence of the message to be sent.

You can specify either of the following characters:

- y: Permanent
- n: Not permanent

-QQ *queue-name*

Modifies the name of the queue used to send the message.

You can specify a character string of 1 to 48 bytes. Specify the queue name using an MQ character string.

-jt {q|n}

Changes the queuing attribute type.

- q: The queuing attribute exists.
- n: The queuing attribute does not exist.

MSMQ-sending-job-information-change-options

These options modify definition information for an MSMQ *sending* job.

-SA *application-information*

Modifies the application information for the message to be sent.

You can specify a hexadecimal value between 0 and FFFFFFFF.

-SH *maintenance-duration*

Modifies the hold time for the message to be sent.

You can specify the following values:

- -1: INFINITE

- n: 0 to 2,147,483,647 (seconds)
- sJ *journal-queue-storage-specification-for-message*
 Modifies the specification for storing the sent message into the journal queue.
 You can specify either of the following characters:
- y: Stores the message into the journal queue.
 - n: Does not store the message into the journal queue.
- SM *message-label*
 Modifies the message label for the message to be sent.
 You can specify a character string of 1 to 249 bytes.
- sL *sending-time-out-limit*
 Modifies the time-out limit for transmitting the message to be sent.
 You can specify the following values:
- -2: LONG_LIVED
 - -1: INFINITE
 - n: 0 to 2,147,483,647 (seconds)
- sM *sending-mode*
 Modifies the sending mode for the message to be sent.
 You can specify either of the following characters:
- h: Transmits the message in the high-speed mode.
 - r: Transmits the message in the restorable mode.
- sP *priority*
 Modifies the priority of the message to be sent.
 You can specify a value between 0 and 7.
- s1 *queue-label-name*
 Modifies the queue label name for the message destination.
 You can specify a character string of 1 to 124 bytes.
- SQ *queue-path-name*
 Modifies the queue path name for the message destination.
 You can specify a character string of 1 to 259 bytes.
- SR *correlation-ID*
 Modifies the correlation ID of the message to be sent.
 You can specify a character string of 1 to 20 bytes. You can, however, specify only uppercase letters and numbers.
- sF *text-file-name*
 Modifies the text file name for the message to be sent.
 You can specify a character string of 1 to 259 bytes. Use a full path to specify the file name.
- sT *text-type*
 Modifies the type of the text of the message to be sent.
 You can specify a hexadecimal value between 0 and FFFFFFFF.
- sU *dead-letter-queue-storage-specification-for-message*
 Modifies the specification for storing the sent message into the dead letter queue.

You can specify either of the following characters:

- **y**: Stores the message into the dead letter queue.
- **n**: Does not store the message into the dead letter queue.

-jt {q|n}

Changes the queuing attribute type.

- **q**: The queuing attribute exists.
- **n**: The queuing attribute does not exist.

HP-NNM-status-report-job-information-change-options

These options modify definition information for an OpenView status report job.

-pf *platform-type*

Modifies the platform type.

You can specify either of the following characters:

- **u**: Operates in a UNIX environment.
- **p**: Operates in a Windows environment.

-CI *message-additional-information-to-post-to-HP NNM*

Modifies the additional information for the message you want to post to HP NNM.

You can specify a character string of 1 to 256 bytes.

-CC *status-to-post-to-HP NNM*

Modifies the status you want to post to HP NNM.

You can specify one of the following character strings:

- **un**: Unknown
- **no**: Normal
- **wa**: Warning
- **mi**: Minor
- **ma**: Major
- **cr**: Critical
- **re**: Restricted
- **te**: Testing
- **di**: Disabled

-jt {q|n}

Changes the queuing attribute type.

- **q**: The queuing attribute exists.
- **n**: The queuing attribute does not exist.

local-power-control-job-information-change-options

These options modify definition information for a local power control job.

-pf *platform-type*

Modifies the platform type.

You can specify either of the following characters:

- u: Operates in a UNIX environment.
- p: Operates in a Windows environment.

-PT *power-control-type*

Modifies the power control type.

You can specify one of the following characters:

- f: Turns off the power.
- r: Shuts down and then restarts the system.
- s: Shuts down the system.

-Pf *shutdown-type*

Modifies the shutdown type.

You can specify one of the following characters:

- m: Performs monitoring termination.
- r: Performs restrictive termination.
- f: Performs forced termination.
- p: Performs planned termination.

-jt {q|n}

Changes the queuing attribute type.

- q: The queuing attribute exists.
- n: The queuing attribute does not exist.

remote-power-control-job-information-change-options

These options modify definition information for a remote power control job.

-pf *platform-type*

Modifies the platform type.

You can specify either of the following characters:

- u: Operates in a UNIX environment.
- p: Operates in a Windows environment.

-PH *power-control-target-host-name*

Modifies the name of the JP1/Power Monitor agent host to which you want to apply power control.

You can specify a character string of 1 to 255 bytes.

-PF *power-control-type*

Modifies the power control type for the JP1/Power Monitor agent host.

You can specify one of the following characters:

- o: Turns on the power.
- m: Performs monitoring termination.
- r: Performs restrictive termination.
- f: Performs forced termination.
- p: Performs planned termination.

- s: Performs forced stop.

–PN *next-power-on-time-setting*

Modifies the setting of the next power-on time for the JP1/Power Monitor agent host.

You can specify one of the following characters or values:

- n: Does not specify a next power-on time.
- a: Enables the next power-on time set for the JP1/Power Monitor agent host.
- c: [MM/DD.]hh:mm Specify the time in the c: [MM/DD.]hh:mm format. You can specify the following values:
MM: 1 to 12 (month)
DD: 1 to 31 (day)
hh: 0 to 23 (hour)
mm: 0 to 59 (minute)

–PR *restart*

Modifies the setting of restart after the shutdown of the JP1/Power Monitor agent host.

You can specify either of the following characters:

- y: Restarts the host.
- n: Does not restart the host.

–PW *power-off-termination-wait*

Modifies the setting of whether to wait for the JP1/Power Monitor agent host to completely turn off before terminating the remote power control job.

You can specify either of the following characters:

- y: Waits for shutdown.
- n: Does not wait for shutdown.

The end of power-off means that the JP1/Power Monitor on the agent host reports the start of a shutdown to the manager host of the JP1/Power Monitor.

–PP *platform-type-of-power-control-target-host*

Modifies the platform type for the host on which you will execute the remote power control job.

You can specify either of the following characters:

- u: Operates in a UNIX environment.
- p: Operates in a Windows environment.

–jt {q|n}

Changes the queuing attribute type.

- q: The queuing attribute exists.
- n: The queuing attribute does not exist.

custom-event-job-information-change-options

These options modify definition information for a custom event job.

–jp *macro-variable-specification*

Modifies the specification of a macro variable.

You can specify this option multiple times in the format `-jp macro-variable-name:passing-information-name`. However, if you specify the same macro variable name more than once, the system only passes the passing information associated with the first instance of the macro variable name.

Specify macro variable names as a string of 1 to 64 bytes in `?AJS2xxxxx?` format. The `xxxxx` part is limited to upper-case alphabetic characters, numeric characters, and periods (.).

You can specify a character string of up to 2,048 bytes in total. This means that the sum of the number of bytes should not exceed 2,048 after the value of the `-jp` option is converted to the `jpouif=?AJS2xxxxx?:passing-information-name`; format that is output with the `ajsprint -a` option.

You can specify the following character strings for *passing-information-name*:

- CMTMOUT: Whether the job has ended due to time-out
- OBJECT01 to OBJECT10: Values set by the linked program

`-cp` *definition-parameter*

Modifies the specified unit definition parameter for a custom event job by specifying the new setting in the *parameter-name=value* format.

You can specify a character string of 2 to 20,479 bytes. If you specify multiple `-cp` options at the same time, the total number of characters in all specified values must not exceed 20,479 minus the number of specified `-cp` options plus 1 (unit: bytes). For example, if you specify five `-cp` options at the same time for one unit, the total number of characters that can be specified for the five values is a maximum of 20,475 (= 20479 - 5 + 1) bytes.

Notes

- Either of the following users can change the job definition:
 - A user who was granted the update privilege when the job was defined or when its attributes were changed
 - A JP1 user mapped to the OS user who has Administrators or superuser privilegesNote, however, that if `yes` is set after changing the `ADMACLIMIT` environment setting parameter from its default, even a JP1 user who was mapped to an OS user with Administrators or superuser privileges must have the update privilege.
- We recommend that you not execute this command during the execution of a jobnet. (This command terminates abnormally if some other process is using the target job. You cannot use JP1/AJS3 - View to manipulate or update a job while you are modifying the definition of the job with this command. You cannot execute a job while you are manipulating it.)
- To modify the definition of a job in a registered jobnet, we recommend that you first cancel the registration of the jobnet. Use the `ajsleave` command when canceling the registration of jobnets.
- If you specify any invalid option for the unit, this command will terminate abnormally.
- If the jobnet for which you modify the definition is a release target jobnet (root jobnet for which release entry is made), the job definitions in the jobnet in *Being applied* status are modified.

Return values

| | |
|--|--------------|
| 0 | Normal end |
| Multiple of 4 within the range from 4 to 124 | Abnormal end |

Additional information

To leave information undefined (default) for one of the following options, specify "" for the option.

- Job common information change option

- UNIX/PC/QUEUE job information change option
- Judgment job information change option
- JP1 event reception monitoring job information change option
- File monitoring job information change option
- Email reception monitoring job information change option
- Message queue reception monitoring job information change option
- MSMQ reception monitoring job information change option
- Log file monitoring job information change option
- Windows event log monitoring job information change option
- Execution interval control job information change option
- JP1 event sending job information change option
- Email sending job information change option
- Message queue sending job information change option
- MSMQ sending job information change option
- OpenView status report job information change option
- Local power control job information change option
- Remote power control job information change option

Example 1

The following command changes the standard output file for job `net1/job1` to `/dev/null`:

```
ajschgjob -so /dev/null /net1/job1
```

Example 2

The following command changes the judgment condition for the judgment job (`net1/jdg1`) to a return code *from 0 to less than 10*.

```
ajschgjob -ej ri -el 0 -lP ge -eh 10 -uP lt /net1/jdg1
```

Format

```
ajschgnet
  [-F service-name]
  [schedule-information-change-options]
  [relationship-change-options]
  [start-condition-information-change-options]
  [jobnet-connector-information-change-options]
  [-S]
  [-R]
  [-L | -E]
  [-T]
  [-N]
  jobnet-name-or-start-condition-unit-name-or-job-group-name...
```

Description

Modifies the definition of a jobnet (schedule definition) and the definition of a start condition unit.

Execution privileges

You must have any of the following JP1 privileges:

- JP1_AJS_Admin privilege
- JP1_AJS_Manager privilege
- JP1_AJS_Editor privilege

Arguments

-F *service-name*

Specify the name of the target scheduler service.

You can specify a character string of 1 to 30 bytes.

-S

This option makes it possible to change the order in which jobnets and jobs are executed, even for suspended jobnets that have been registered for execution.

-R

Modifies the definitions of the specified jobnet or all jobnets contained in the specified job group.

If you specify this option with the **-L**, **-E**, **-T**, and/or **-N** options, the system modifies the definitions according to the specification of each option.

-L

Modifies the definitions of jobnets not registered for execution.

If you specify this option with the **-T** and/or **-N** options, the system modifies the definitions of unregistered jobnets according to the specification of each option. You cannot specify this option with the **-E** option.

-E

Modifies the definitions of jobnets registered for execution.

If you specify this option with the `-T` and/or `-N` options, the system modifies the definitions of registered jobnets according to the specification of each option. You cannot specify this option with the `-L` option.

-T

Modifies the definitions of root jobnets.

If you specify this option with the `-E` or `-L` options, the system modifies the definitions of root jobnets according to the specification of each option. If you specify this option with the `-N` option, the `-N` option is disabled.

-N

Modifies the definitions of jobnets.

If you specify this option with the `-E` or `-L` option, the system modifies the definitions of jobnets according to the specification of each option. If you specify this option with the `-T` option, this option is disabled.

jobnet-name-or-start-condition-unit-name-or-job-group-name

Specify the full name of a jobnet or start condition unit for which you want to modify definitions. Alternatively, you can specify the full name of the jobnet, start condition unit, or job group with the `-R`, `-L`, `-E`, `-T`, or `-N` option.

You can specify a character string of 1 to 930 bytes.

You can specify more than one jobnet name or job group name.

You can specify a logical host name as a jobnet or job group name. You cannot specify an execution ID.

schedule-information-change-options

These options modify the schedule defined for a jobnet (if you modify the schedule, the system will recalculate the schedule upon the end of command execution).

-DD *job-group-name*

Specify the name of the job group in which the target calendar information is defined, when modifying the calendar information.

You can specify a character string of 1 to 930 bytes.

```
-dd [N, ] { [ [year/] month/ ] { [+|*|@] day| [+|*|@] b[-day] | [+ ] { sun|su|mon|mo|tue|tu|wed|we|thu|th|fri|fr|sat|sa } [ : {n|b} ] } | en|ud|undefine }
```

Modifies the date on which you want to start executing the jobnet.

You can specify up to 144 dates in one command.

To clear all definitions, specify either `-dd 0, ud` or `-dd 0, undefine`.

- *N*

Specify the corresponding rule number if you specify more than one starting date for executing the jobnet.

You can specify a value between 0 and 144.

By default, the system assumes 1 as the rule number (that is, you will modify a schedule having a rule number of 1).

- *year*

Specify the year of the starting date for executing the jobnet.

You can specify a value between 1994 and the value of the `SCHEDULELIMIT` environment setting parameter for the year. For details about the `SCHEDULELIMIT` environment setting parameter, see 20.4.2(123) `SCHEDULELIMIT` in the *JPI/Automatic Job Management System 3 Configuration Guide*.

By default, the system assumes the year in which you registered the jobnet for execution.

- *month*

Specify the month of the starting date for executing the jobnet.

You can specify value between 1 and 12 for the month.

By default, the system assumes the month in which you registered the jobnet for execution.

- +

Specify the execution start date using the number of days following the base date.

- *

Specify the execution start date using the number of open days following the base date.

- @

Specify the execution start date using the number of closed days following the base date.

- *day*

Specify the day of the execution start date.

You can specify the following values:

When specifying an absolute date

- Year/month/day specification: 1 to last day of specified year/month.
- Month/day specification: 1 to last day of specified month. For February, however, 1 to 29.
- Day specification: 1 to 31.

When specifying a relative date or the number of open or closed days

1 to 35 (days).

If you omit the specification of + (relative date), * (number of open days) or @ (number of closed days), the system assumes an absolute day of the month in which you registered the jobnet for execution.

- *b*

Sets the last day of the month to the jobnet start date.

- *-day*

Specify the starting date for executing the jobnet using the number of days between the date and the end of the month.

You can specify the following values:

When specifying an absolute date

- Year/month/day specification: 0 to (last day of specified year/month -1).
- Month/day specification: 0 to (last day of specified month -1). For February, however, 0 to 28.
- Day specification: 0 to 30.

When specifying a relative date or the number of open or closed days

0 to 34 (days).

You can specify this option with + (relative date), * (number of open days) or @ (number of closed days).

- *sun | su | mon | mo | tue | tu | wed | we | thu | th | fri | fr | sat | sa*

Specify Sunday, Monday, Tuesday, Wednesday, Thursday, Friday and Saturday as the starting date for executing the jobnet.

- *n*
Specify the week for the day; a value between 1 and 5 (specifying 1 for Sunday, for example, indicates the first Sunday of the month).

By default, the system assumes the start date to be the next day of the week after the date when the jobnet was registered for execution and the date when the `ajsschedule` command was executed. If you do not specify anything when either *year* or *month* is specified for the execution start date, the system assumes the first week when you register anything for execution and when you execute the `ajsschedule` command.

- *en*
Changes the defined execution start date to the date on which you registered the jobnet for execution.
- *ud|undefine*
Clears the entire schedule for the jobnet.
If you specify this option, specify 0 for *N* (jobnet rule number).
Specifying this option causes the `-dd`, `-tt`, `-VV`, `-WW`, `-KK`, `-yy`, `-ss`, `-hh`, `-wt`, `-wc`, `-ct`, `-cc`, and `-ce` options to be disabled.

`-tt` [*N*,] [*+*] *hours:minutes*

Modifies the time at which you want to start executing the jobnet.

You can specify up to 144 times in one command.

- *N*
Specify the corresponding rule number if you specify more than one starting date for executing the jobnet.
You can specify a value between 1 and 144.
By default, the system assumes 1 as the rule number (that is, you will modify a schedule having a rule number of 1).
- *+*
Handles the time specified with *hour:minute* as a relative time.
By default, the system handles the specified time as an absolute time.
- *hour:minutes*
Specify the starting time for executing the jobnet.
You can specify a value between 0 and 47 for the hour.
You can specify a value between 0 and 59 for the minute.

`-VV` [*N*,] { *hours:minutes* | *M-minutes* | *U-minutes* | *C-minutes* }

Modifies the delay time for starting the jobnet.

You can specify up to 144 times in one command.

- *N*
Specify the corresponding rule number if you specify more than one delay time for starting the jobnet.
You can specify a value between 1 and 144.
By default, the system assumes 1 as the rule number (that is, you will modify a schedule having a rule number of 1).
- *hour:minutes*
Specify an absolute time.
You can specify a value between 0 and 47 for the hour.
You can specify a value between 0 and 59 for the minute.
- *M-minutes*
Specify the number of minutes relative to the starting time for executing the root jobnet.

You can specify a value between 1 and 2,879 for the minute.

- *U-minutes*

Specify the number of minutes relative to the starting time for executing the upper-level jobnet.

You can specify a value between 1 and 2,879 for the minute.

- *C-minutes*

Specify the number of minutes relative to the starting time for executing the relevant jobnet.

You can specify a value between 1 and 2,879 for the minute.

-WW [*N*,] { *hours:minutes* | *M-minutes* | *U-minutes* | *C-minutes* }

Modifies the delay time for ending the jobnet. You can specify up to 144 times in one command.

- *N*

Specify the rule number if you specify more than one delay time for ending the jobnet.

You can specify a value between 1 and 144.

By default, the system assumes 1 as the rule number (that is, you will modify a schedule having a rule number of 1).

- *hour:minutes*

Specify an absolute time.

You can specify a value between 0 and 47 for the hour.

You can specify a value between 0 and 59 for the minute.

- *M-minutes*

Specify the number of minutes relative to the starting time for executing the root jobnet.

You can specify a value between 1 and 2,879 for the minute.

- *U-minutes*

Specify the number of minutes relative to the starting time for executing the upper-level jobnet.

You can specify a value between 1 and 2,879 for the minute.

- *C-minutes*

Specify the number of minutes relative to the starting time for executing the relevant jobnet.

You can specify a value between 1 and 2,879 for the minute.

-KK [*N*,] *linked-rule-number*

Modifies the rule number to be linked with that for the upper-level jobnet if you have more than one schedule defined.

You can specify up to 144 numbers in one command. You cannot specify a rule number for the root jobnet.

- *N*

Specify the rule number for the schedule for the jobnet.

You can specify a value between 1 and 144.

By default, the system assumes 1 as the rule number (that is, you will modify a schedule having a rule number of 1).

- *linked-rule-number*

Specify the rule number for the upper-level jobnet that corresponds to the above rule number.

-yy [*N*,] *processing-cycle*, { *y* | *m* | *w* | *d* }

Modifies the processing cycle for the jobnet.

You can specify up to 144 processing cycles.

- *N*

Specify the rule number for the corresponding jobnet.

You can specify a value between 1 and 144.

By default, the system assumes 1 as the rule number (that is, you will modify a schedule having a rule number of 1).

- *processing-cycle*, {y|m|w|d}

Modify the processing cycle and its unit (for example, specify `-yy 6, m` to process the jobnet at intervals of six months).

- y

Specifies the processing cycle in years. You can specify a value between 1 and 9 for the processing cycle.

- m

Specifies the processing cycle in months. You can specify a value between 1 and 12 for the processing cycle.

- w

Specifies the processing cycle in weeks. You can specify a value between 1 and 5 for the processing cycle.

You cannot specify this if an open day or closed day is used to define the starting date for executing the jobnet. If you specify this, the schedule is calculated assuming that one week is equal to seven open days or seven closed days; however, we recommend that you specify the processing cycle on a daily basis. A good example would be "7, d", instead of "1, w".

- d

Specifies the processing cycle in days. You can specify a value between 1 and 31 for the processing cycle.

`-ss [N,] {af|be|no|ca}`

Modifies the method of shifting the execution date if the scheduled date of jobnet execution falls on a closed day in the JP1/AJS3 calendar.

You can specify up to 144 methods in one command.

- N

Specify the rule number for the corresponding jobnet.

You can specify a value between 1 and 144.

By default, the system assumes 1 as the rule number (that is, you will modify a schedule having a rule number of 1).

- af

Executes the jobnet by shifting the execution day to a day after the scheduled date of execution.

- be

Executes the jobnet by shifting the execution day to a day before the scheduled date of execution.

- no

Forcibly executes the jobnet even if the scheduled date of execution is a closed day, provided a scheduler service is running.

- ca

Does not execute the jobnet if the scheduled date of execution is a closed day.

`-hh [N,] shift-days`

If you specify `af` (shifting to a day after the execution day) or `be` (shifting to a day before the execution day) for the `-ss` option, the `-hh` option specifies the period into which the system can shift the execution day.

You can specify up to 144 periods.

- N

Specify the rule number for the jobnet.

You can specify a value between 1 and 144.

By default, the system assumes 1 as the rule number (that is, you will modify a schedule having a rule number of 1).

- *shift-days*

You can specify a number between 1 and 31 (days). (For example, specify `-ss af -hh 5` if you want the system to find a substituting execution day by selecting each following day within five days including the scheduled execution day.)

`-wt [N,] {no | hours:minutes | relative-minutes | un }`

Modifies the time between the jobnet being placed into the event wait status and the event wait status being released. You can specify up to 144 times in one command.

If you specify `no` for the `-wc` option, you can only specify `no` for this option.

- *N*

Specify the rule number for the corresponding jobnet.

You can specify a value between 1 and 144.

By default, the system assumes 1 as the rule number (that is, you will modify a schedule having a rule number of 1).

- `no`

Does not use a start condition.

- *hour:minutes*

Specify the wait time as absolute time.

You can specify a value between 0 and 47 for the hour.

You can specify a value between 0 and 59 for the minute.

- *relative-minutes*

Specify a time relative to the scheduled start time for the jobnet.

You can specify a value between 1 and 2,879 (minutes).

- `un`

Waits for an unlimited period of time until the condition is satisfied.

`-wc [N,] {no | valid-number-of-waits-for-events | un }`

Modifies the number of times the system will wait for events after it completes the execution of the event-activated jobnet.

You can specify up to 144 times in one command.

If you specify `no` for the `-wt` option, you can only specify `no` for this option.

- *N*

Specify the rule number for the corresponding jobnet.

You can specify a value between 1 and 144.

By default, the system assumes 1 as the rule number (that is, you will modify a schedule having a rule number of 1).

- `no`

Does not use a start condition.

- *valid-number-of-waits-for-events*

Specify the number of times the system will wait for events.

You can specify a value between 1 and 999 (times).

- `un`

Sets an unlimited number of times for waiting.

-pp *year/month/day*

Modifies the expiration date for jobnet execution.

- *year*

Specify the year of the expiration date.

You can specify a value between 1994 and the value of the SCHEDULELIMIT environment setting parameter for the year. For details about the SCHEDULELIMIT environment setting parameter, see 20.4.2(123) SCHEDULELIMIT in the *JP1/Automatic Job Management System 3 Configuration Guide*.

- *month*

Specify the month of the expiration date.

You can specify value between 1 and 12 for the month.

- *day*

Specify the day of the expiration date.

You can specify a value between 1 and 31 for the day.

-ll *number-of-logs-to-keep*

Modifies the number of logs to store the results of jobnet execution.

You can specify a number between 1 and 99 (logs).

You can, however, enable the system setting option to increase the number of generations up to 999.

-nn *priority-value*

Modifies the priority for jobnet execution.

You can specify a value between 1 and 5.

The lowest priority is 1 and the highest is 5.

-bb {y|w|a|n}

Modifies the hold attribute for the jobnet. If you specify w or a for a nested jobnet, the system assumes n.

- y

Holds the execution of the jobnet.

- w

Holds execution only if the previous execution of the jobnet has terminated abnormally or with a warning.

- a

Holds execution only if the previous execution of the jobnet has terminated abnormally.

- n

Does not hold the execution of the jobnet.

-ej *exclusive-jobnet-name*

Modifies the name of the jobnet which should not be executed on the same date (name of a jobnet in the same layer).

You can specify a character string of 1 to 30 bytes.

You cannot specify the name of a local jobnet.

-ct [*N*,] {no|be|af|db|da}

Modifies the method for scheduling the jobnet by days from start time.

You can specify up to 144 methods in one command.

- *N*

Specify the rule number for the corresponding jobnet.

You can specify a value between 1 and 144.

By default, the system assumes 1 as the rule number (that is, you will modify a schedule having a rule number of 1).

- no

Does not schedule the jobnet by days from start time.

If you specify this option together with the `-cc` (for specifying the number of days for scheduling the jobnet by days from start time) or `-ce` (for specifying the number of shift days for scheduling the jobnet by days from start time) option for the same rule number, the KAVS0159-W message is output. Then, the specification of the `-ce` or `-cc` option is ignored.

- be

Shifts the scheduled date of execution to a previous open day, relative to the shift date specified with the `-ss` option.

- af

Shifts the scheduled date of execution to a subsequent open day, relative to the shift date specified with the `-ss` option.

- db

Shifts the scheduled date of execution to a previous day, relative to the shift date specified with the `-ss` option. If you specify this option, closed days are also subject to substitute scheduling.

If you specify this option together with the `-ce` option (for scheduling the jobnet by days from the start time) for the same rule number, the KAVS0159-W message is output. Then, the specification of the `-ce` option is ignored.

- da

Shifts the scheduled date of execution to a subsequent day, relative to the shift date specified with the `-ss` option. If you specify this option, closed days are also subject to substitute scheduling.

If you specify this option together with the `-ce` option (for scheduling the jobnet by days from the start time) for the same rule number, the KAVS0159-W message is output. Then, the specification of the `-ce` option is ignored.

`-cc` [*N*,] *number-of-days-for-schedule-by-days-from-start-time*

Modifies the number of days for scheduling a jobnet by days from the start time.

You can specify up to 144 numbers in one command.

- *N*

Specify the rule number for the corresponding jobnet.

You can specify a value between 1 and 144.

By default, the system assumes 1 as the rule number (that is, you will modify a schedule having a rule number of 1).

- *number-of-days-for-schedule-by-days-from-start-time*

You can specify a value between 1 and 31 (days).

`-ce` [*N*,] *shift-days-for-schedule-by-days-from-start-time*

Modifies the number of shift days for scheduling a jobnet by days from the start time.

You can specify up to 144 numbers in one command.

- *N*

Specify the rule number for the corresponding jobnet.

You can specify a value between 1 and 144.

By default, the system assumes 1 as the rule number (that is, you will modify a schedule having a rule number of 1).

- *shift-days-for-schedule-by-days-from-start-time*
You can specify a value between 1 and 31 (days).

`-cd {no|un|n}`

Modifies the number of days after which the system terminates a wait status, such as event activation wait or execution wait. You can specify this option only for the root jobnet.

- `no`
Cancels the setting of the number of days for termination.
Once you cancel the setting, the value set for the system option becomes valid as the time the system will wait before termination.
- `un`
Waits for an unlimited time of period without terminating the wait status.
- `n`
Specify the number of days the system will wait before terminating a wait status.
You can specify a value between 1 and 2 for the day.

`-de {y|n}`

Modifies dependency with the schedule for the upper-level jobnet.

You cannot specify a rule number for the root jobnet.

- `y`
Depends on the schedule for the upper-level jobnet. You cannot specify this option with an option for changing the schedule rule.
- `n`
Does not depend on the schedule for the upper-level jobnet.

`-ms {sch|mlt}`

Modifies the scheduling method for multiple jobnet activation.

You can specify this option only for the root jobnet.

- `sch`
Activates jobnets by applying the schedule skip method.
- `mlt`
Activates jobnets by applying the multi-schedule method.

`-mp {y|n}`

Modifies the settings for multiple jobnet activation. You can specify this option only for the root jobnet.

- `y`
Enables multiple activation.
- `n`
Disables multiple activation.

`-ah remote-jobnet-execution-agent-host-name`

Modifies the name of the remote jobnet execution agent host.

You can specify a character string of 1 to 255 bytes.

`-ex job-execution-agent-host-name`

Modifies the name of the job execution agent host.

You can specify a character string of 1 to 255 bytes.

-fd *time-required-for-execution*

Modifies the time required for executing the jobnet or remote jobnet for which the end delay is monitored.
You can specify a value between 1 and 2,879 (minutes).

relationship-change-options

These options modify the relationship of the execution order for jobnets and jobs. You can specify this option only for a jobnet.

You can specify up to 20 -AA options (make relation options) and 20 -BB options (break relation options) in one command.

-AA *preceding-unit-name, succeeding-unit-name* [, {seq|con}]

Specify the names of the preceding and succeeding units between which you want to create a relationship (associate units). You must also specify the connection type.

You can specify a character string of 1 to 30 bytes for each unit name (*preceding-unit-name and succeeding-unit-name*).

If the relation line is already set for the preceding and succeeding units whose relationship is to be set, the command returns 0 and ends normally.

- seq
Specifies forward connection.
- con
Specifies the judgment connection of a judgment job and a dependent unit.

The system does not create a relationship in any of the following cases:

- If the same unit name is specified for the preceding unit as well as the succeeding unit
- If the unit of the specified preceding unit name or succeeding unit name does not exist
- If a recovery unit is specified as the preceding unit name, and a regular unit is specified as the succeeding unit name
- If you attempt to set a reverse relationship for units between which you have already set a relationship
- If you specify a relationship and cancel a relationship, at the same time, between the same preceding unit and succeeding unit
- If you specify a job group, manager job group, manager jobnet, or root jobnet
- If there are two or more preceding units when the succeeding unit is a judgment job
- If the preceding unit is other than an event job or a custom event job when the succeeding unit is an OR job
- If you specify a unit other than a judgment job as the preceding unit for a judgment connection
- If the judgment connection of a judgment job and a dependent unit makes other than 1-to-1 matching
- If you specify the name of a unit with start conditions in the preceding unit name or the succeeding unit name

-BB *preceding-unit-name, succeeding-unit-name*

Specify the names of the preceding and succeeding units between which you want to break a relationship (cancels the association between units).

You can specify a character string of 1 to 30 bytes for each unit name.

If the relation line does not exist for the preceding and succeeding units whose relationship is to be broken, the command returns 0 and ends normally.

start-condition-information-change-options

This option modifies the attribute of the start condition.

`-rc {and|or}`

Specify how the conditions must be satisfied to start the jobnet.

- `and`
Starts the jobnet when all conditions are satisfied.
- `or`
Starts the jobnet when at least one of the conditions is satisfied.

`-ab {exec|hold|stop}`

For a jobnet with start conditions, this parameter specifies the behavior of the jobnet's execution generations whose start conditions are satisfied, if the preceding execution generation has terminated abnormally.

- `exec`
Executes the jobnet generations whose start conditions are satisfied.
- `hold`
Holds the execution of the jobnet generations whose start conditions are satisfied.
- `stop`
Stops the jobnet that is monitoring whether the start conditions are satisfied (the monitoring generation of the jobnet).

`-mS {m|w|s}`

Specifies the action taken if there is already a monitored jobnet generation in *Now monitoring* status when monitoring of start conditions starts.

- `m`
Generates a new monitoring generation in addition to the existing monitoring generation in *Now monitoring* status. In this case, note that as many start conditions as there are jobnet generations in *Now monitoring* status are satisfied.
- `w`
Waits until the monitoring generation in *Now monitoring* status terminates. If a timeout has been set for execution of this jobnet generation, and the execution times out, the monitoring generation is placed in *Skipped so not executed* status.
- `s`
Skips starting the monitoring generation of the jobnet, and places the generation in *Skipped so not executed* status.

`-gs {y|n}`

Specifies whether to stay execution of a generation of a jobnet if the generation's start conditions are satisfied while another generation is already running when concurrent execution of jobnet generations is disabled.

- `y`
Execution of the jobnet is not repeated so that the generation stays.
- `n`
Execution of the jobnet is repeated so that the generation does not stay.

jobnet-connector-information-change-options

These options modify the jobnet connector attributes.

`-lr connection-destination-jobnet-name`

Specify the full name of a unit (root jobnet or planning group) that will become the jobnet to which the jobnet connector will be connected.

You can specify a character string of 1 to 930 bytes.

You can specify this option for only a jobnet connector that has not been registered.

`-cx linkage-of-root-jobnet-execution-order-control-between-scheduler-services`

Specify whether to establish linkage between scheduler services when the execution order of root jobnets is controlled.

You can specify this option for only a jobnet connector that has not been registered.

If you change the value of this option from `y` to `n`, the specifications of the `-ch` (host to connect) and `-cs` (connection service name) options are cleared (neither `y` nor `n` is set).

- `y`

Linkage between scheduler services is established.

Root jobnet execution order control is linked with jobnet connectors including those defined on other hosts or those defined in other scheduler services.

- `n`

Linkage between scheduler services is not established.

Root jobnet execution order control is linked with only jobnet connectors defined in the same scheduler service.

`-ch connection-host-name`

Specify the name of the host on which a jobnet connector to be connected is defined. You can specify a character string of 1 to 255 bytes. You cannot specify space, tab, or linefeed characters.

You can specify this option only if `y` is specified for the `-cx` option (linkage of root jobnet execution order control between scheduler services).

`-cs connection-service-name`

Specify the name of the scheduler service on which a jobnet connector to be connected is defined. You can specify a character string of 1 to 30 bytes. You cannot specify a null string ("") to reset the scheduler service name definition to the default status.

You can specify this option only if `y` is specified for the `-cx` option (linkage of root jobnet execution order control between scheduler services).

Notes

- Either of the following users can change the jobnet definition:
 - A user who was granted the update privilege when the jobnet was defined or when its attributes were changed
 - A JP1 user mapped to the OS user who has Administrators or superuser privilegesNote, however, that if `yes` is set after changing the `ADMACLIMIT` environment setting parameter from its default, even a JP1 user who was mapped to an OS user with Administrators or superuser privileges must have the update privilege.
- We recommend that you not execute this command during the execution of a jobnet. (This command terminates abnormally if some other process is using the target jobnet. You cannot use JP1/AJS3 - View to manipulate or update a unit while you are modifying the definition of the jobnet with this command. You cannot execute a jobnet or job while you are manipulating it.
- We recommend that you cancel the registration of jobnets before attempting to change the contents of the definitions of registered jobnets. Use the `ajsleave` command when canceling the registration of jobnets. With the target jobnet suspended, however, specifying the `-s` option in this command makes it possible to change the order of execution of jobnets and jobs without having to cancel the registration of jobnets.

- Modifying the schedule disables any temporary plan modification you specified previously.
- If you shift the execution start day to a day previous to the target day, the schedule for the past becomes invalid.
- The command terminates abnormally if the jobnet in which an attempt is made to change related information is in the process of a suspended-status change.
- If you use the command to define a jobnet, the system does not check the consistency of the execution order of units. If the units are associated so that their execution order loops, the jobnet will cause an error during execution because the order of the element's execution is invalid.
- To leave information undefined (default), specify "" for the option.
- If you specify the `-tt`, `-VV`, `-WW`, `-KK`, `-yy`, `-ss`, `-hh`, `-wt`, `-wc`, `-ct`, `-cc`, or `-ce` option with a rule number not contained in the schedule definition for the jobnet, the command will end normally, without adding any schedule. When adding a schedule, also specify the `-dd` option.
- If the release target jobnet (root jobnet for which release entry is made) is changed, the jobnet definitions in *Being applied* status are also changed.
- Execute changes in schedule information when there are only a few tasks. If you specified schedule-information-change-options, while this command is being executed, the system suppresses the execution of root jobnets registered for execution in the same scheduler service as jobnets that change schedule information, which might impact tasks. However, for jobnets with start conditions whose status is *Now monitoring* before the change in definitions, if the start conditions are established then those jobnets will be executed.

Return values

| | |
|--|--------------|
| 0 | Normal end |
| Multiple of 4 within the range from 4 to 124 | Abnormal end |

Additional information

To leave information undefined (default) for the schedule information change option, the related information change option, or the start condition information change option, specify "" for the option.

Example 1

The following command changes the starting time for executing jobnet `net1` to 17:00 (absolute time) on every Friday in October 2010. It also changes the processing cycle to a weekly schedule:

```
ajschgnet -dd 2010/10/fr -tt 17:00 -yy 1, w net1
```

Example 2

The following command makes a relationship between two jobs, `net1/job1` and `net1/job2`:

```
ajschgnet -AA job1, job2 net1
```

Example 3

The following command sets the connection-destination jobnet name in jobnet connector `/net2/netcon1` so that the jobnet connector connects to root jobnet `/net1`:

```
ajschgnet -lr /net1 /net2/netcon1
```

Example 4

The following commands change the start conditions (.CONDITION) of root jobnet /JOBNET1 as follows:

- If there is already a monitored jobnet generation in *Now monitoring* status when monitoring of start conditions starts, processing waits for the generation to terminate.

```
ajschgnet -F AJSROOT1 -mS w /JOBNET1/.CONDITION
```

- If start conditions of a jobnet generation are satisfied while another generation is already running, execution of the jobnet is repeated so that the generation will not stay.

```
ajschgnet -F AJSROOT1 -gs n /JOBNET1/.CONDITION
```

ajschgstat

Format

```
ajschgstat
  [-F service-name]
  [-t new-status]
  [-v current-status]
  [-c return-code]
  [-h execution-host-name]
  [-B execution-registration-number]
  [-R]
  [-E]
  [-J]
  [-X {yes|no|auto}]
  job-name-or-jobnet-name-or-job-group-name...
```

Description

The `ajschgstat` command changes the status of a job or jobnet connector. Changing the status of a job also changes the status of a jobnet containing that job.

Execution privileges

You must have any of the following JP1 privileges:

- JP1_AJS_Admin privilege
- JP1_AJS_Manager privilege
- JP1_AJS_Operator privilege

Arguments

-F *service-name*

Specify the name of the target scheduler service.

You can specify a character string of 1 to 30 bytes.

-t *new-status*

Specify the new status to which you want to change the current status of a job or jobnet connector. You cannot specify this option for a judgment job.

[Table 3-4](#) shows the statuses that can be specified and their meanings.

[Table 3-5](#) shows which new statuses you can specify for a job when you want to change the current status. Likewise, [Table 3-6](#) shows which new statuses you can specify for a jobnet connector when you want to change the current status.

Table 3–4: Statuses after change

| Status | Description |
|--------|--|
| normal | Ended normally |
| fail | Failed to start You cannot specify this for jobnet connector. |

| Status | Description |
|----------|---|
| warning | Ended with warning |
| abnormal | Ended abnormally |
| bypass | Bypassed You cannot specify this for jobnet connector. |
| exit | Change the status according to the return code and job threshold. Changed to "Ended normally," "Ended with warning", or "Ended abnormally." You cannot specify this for OR jobs, event jobs, custom event jobs, action jobs, or jobnet connector. |

Table 3–5: Possible combinations (for a job)

| Current | New | | | | |
|-----------------------------|----------------|-----------------|--------------------|------------------|----------|
| | Ended normally | Failed to start | Ended with warning | Ended abnormally | Bypassed |
| Waiting for previous to end | -- | -- | -- | -- | -- |
| Being held | -- | -- | -- | -- | -- |
| Waiting to execute | Indeterminate | Indeterminate | Indeterminate | Indeterminate | -- |
| Now queuing | Yes | Yes | Yes | Yes | -- |
| Now running | Yes | -- | Yes | Yes | -- |
| Ended normally | N/A | Yes | Yes | Yes | Yes |
| Failed to start | Yes | N/A | Yes | Yes | Yes |
| Ended with warning | Yes | Yes | N/A | Yes | Yes |
| Ended abnormally | Yes | Yes | Yes | N/A | Yes |
| Killed | Yes | Yes | Yes | Yes | Yes |
| Unknown end status | Yes | Yes | Yes | Yes | Yes |
| Not executed, and ended | Yes | Yes | Yes | Yes | Yes |
| Bypassed | Yes | Yes | Yes | Yes | N/A |
| Running + Abend | Yes | -- | -- | -- | -- |

Legend:

Yes: Possible

Indeterminate: Possible for queueless jobs and not possible for other jobs.

--: Not possible

N/A: Not applicable

Table 3–6: Possible combinations (for a jobnet connector)

| Current | New | | |
|-----------------------------|----------------|--------------------|------------------|
| | Ended normally | Ended with warning | Ended abnormally |
| Not sched. to exe. | No | No | No |
| Waiting for previous to end | No | No | No |
| Not executed, and ended | Yes | Yes | Yes |

| Current | New | | |
|--------------------|----------------|--------------------|------------------|
| | Ended normally | Ended with warning | Ended abnormally |
| Bypassed | Yes | Yes | Yes |
| Now running | Yes | Yes | Yes |
| Running + Warning | Yes | Yes | Yes |
| Running + Abend | Yes | Yes | Yes |
| Ended normally | -- | Yes | Yes |
| Ended with warning | Yes | -- | Yes |
| Ended abnormally | Yes | Yes | -- |
| Killed | Yes | Yes | Yes |
| Unknown end status | Yes | Yes | Yes |
| Shutdown | Yes | Yes | Yes |

Legend:

Yes: Possible

No: Not possible

--: Not applicable

-v *current-status*

Specify the current status of the job.

The system can change the status of the job only if the current status of the job coincides with the status specified with this option. You cannot specify this option for a judgment job.

The following table lists the statuses you can specify.

Table 3–7: Statuses before change

| Status | Description |
|-----------|--|
| queuing | Now queuing |
| running | Now running |
| normal | Ended normally |
| fail | Failed to start |
| warning | Ended with warning |
| abnormal | Ended abnormally |
| unknown | Unknown end status |
| unexec | Not executed, and ended |
| bypass | Bypassed |
| abend | Failed to start, Ended abnormally, Killed, Unknown end status or Not executed, and ended |
| exec-wait | Waiting to execute |
| noend | Now queuing or Now running |

-c return-code

Specify the return code for the job.

UNIX

You can specify a value between 0 and 255.

Windows

You can specify a value between -2,147,483,648 and 2,147,483,647.

This option is valid only when the job is currently placed in an end status or when you change the job to an end status (an end status refers to "Ended normally," "Failed to start," "Ended with warning," "Ended abnormally," "Unknown end status," "Not executed, and ended" or "Bypassed"). You cannot specify this option when changing the status of a jobnet connector.

To set the job end result according to the value of the return code specified with this option, specify exit for the `-t` option. Note, however, that you cannot specify the `-t` option for a judgment job. You can only change the return code.

If you use the `-t` option to set the end status for a running job without specifying the `-c` option, the system assumes 0 as the return code.

-h execution-host-name

Specify the name of the host to execute the job.

You can specify a character string of 1 to 255 bytes.

-B execution-registration-number

Specify the execution registration number of the jobnet containing the job for which you want to change the status, in the *YYYYMMDDNNN* format. The meaning of *YYYYMMDDNNN* is as follows:

YYYY: Year of the date of execution

MM: Month of the date of execution

DD: Day of the date of execution

NNN: Execution registration sequence number for the date of execution

If you omit this option, the system assumes the execution registration number for the root jobnet containing the target job. (If the root jobnet is running, the system assumes the execution registration number for the current generation. Otherwise, the system assumes the execution registration number for the last generation in the log information.)

For details of the execution registration number, see *4.5.13 Methods of specifying generations when executing commands* in the manual *JP1/Automatic Job Management System 3 Overview*.

-R

Specify this option if you want to change the status of all jobs or jobnet connectors included in the specified unit.

If you specify this option with the `-E` or `-J` option, the system modifies the status of jobs or jobnet connector according to the specification of each option.

-E

Changes the status of jobs in a jobnet registered for execution or the status of jobnet connector.

-J

Changes the status of a job.

-X {yes|no|auto}

Specify whether to automatically select the current unit for operation from the units listed in a planning group. The units in the job group are not, however, automatically selected regardless of the specified value. You cannot omit a root jobnet name.

- `yes`

Specify this to automatically select a target unit.

When specifying a unit name in the command, omit a root jobnet name in a planning group.

- `no`

Specify this if you do not want to automatically select a target unit.

You must specify a unit for which the command will operate. You cannot omit a root jobnet name in a planning group.

- `auto`

Whether a target unit will automatically be selected depends on how the unit name is specified.

- If you want to automatically select a target unit

Specify a unit name without a root jobnet name in a planning group.

- If you do not want to automatically select a target unit

Specify a unit name with a root jobnet name in a planning group. The command will operate for the specified unit only. However, if there is a unit having the same name as the path name specified without a root jobnet name in a planning group, a root jobnet name is assumed to be omitted so that a target unit will be selected automatically.

job-name-or-jobnet-name-or-job-group-name

Specify the name of the job for which you want to change the status. You can also specify a job name, jobnet name, or job group name with the `-R`, `-E`, or `-J` option.

You can specify a character string of 1 to 930 bytes.

You can specify more than one job name, jobnet name or job group name.

You can specify an execution ID as a job name. If you specify an execution ID, however, the `-B` option is disabled. For details about how to specify the execution ID, see [1.1 Command syntax](#).

You cannot specify a logical host name.

Notes

- Either of the following users can execute the command:
 - A user granted the operation privilege for the unit whose status is to be changed
 - A JP1 user mapped to the OS user who has Administrators or superuser privileges
Note, however, that if `yes` is set after changing the `ADMACLIMIT` environment setting parameter from its default, even a JP1 user who was mapped to an OS user who has Administrators or superuser privileges must have the operation privilege.
- This command terminates abnormally if you execute it when a scheduler service is not running.
- If you use JP1/AJS3 - View or the `ajschgstat` command to change a job that is being executed to the end status, execution of the succeeding unit will begin according to the status to which the preceding job was changed. If you change an abnormally ended job to the normal end status, however, the succeeding unit will not be executed.

- If you use JP1/AJS3 - View or the `ajschgstat` command to change the end status of a job being executed, an event, a message, or log information indicating the end of the job is output. If you change the status of an ended job, no event, message, or log information indicating the end of the job is output.
- If you use JP1/AJS3 - View or the `ajschgstat` command to change a job that is being executed to the end status, the job continues running. In such cases, until the currently running job actually ends, the agent management control will count the job toward the maximum number of jobs that can be executed concurrently.
- After changing the status of a job, you can use the `ajsagtshow` and the `jpqagtshow` commands to check the actual number of jobs in the queue and the number of jobs currently running. For details about these commands, see *ajsagtshow* in 3. *Commands Used for Normal Operations*, and see *jpqagtshow* in 4. *Commands Used for Special Operation*.
- You cannot use this command for units subordinate to remote jobnets.
- This command terminates abnormally if the target job is in a suspended state.
- You cannot change the status of an event job, a custom event job or a judgment job defined in start conditions.
- When you specify that a target unit automatically be selected from the units in a planning group, an error occurs if you do not have the appropriate operation privilege for the automatically selected unit.
- When the `-X` option is omitted, a target unit in a planning group is determined according to the value specified for the `AJSAUTOJUDGE` environment variable.
- For an explanation of how to specify the name of a unit in a planning group, see *Additional information* in *ajsplan* in 3. *Commands Used for Normal Operations*.
- The command cannot perform an operation on suspended jobnet connectors.

Return values

| | |
|--|--------------|
| 0 | Normal end |
| Multiple of 4 within the range from 4 to 124 | Abnormal end |

Example

The following command changes the status of the abnormally ended job (`job1`) to "Ended normally." This job is contained in the root jobnet (`net1`) and the job group name is set in environment variable `AJSPATH` (if the job group name is set in environment variable `AJSPATH`, you can omit the specification of the job group when executing the command).

```
ajschgstat -t normal -v abnormal net1/job1
```

ajschkdef

Format

```
ajschkdef
  [-F service-name]
  [{-s|-a}]
  [-O] [-M] [-C] [-P] [-H] [-D] [-U] [-A]
  [-p execution-agent-profile-name]
  [-e unit-attribute-profile-name]
  [-u registered-user-name]
  [-o output-file-name]
  [-R]
  [-L]
  [-T]
  [-N]
  [-J]
  job-name, jobnet-name-or-job-group-name...
```

Description

Starts the execution of a definition pre-check and displays the state of execution.

Execution privileges

In Windows: Administrators privileges

In UNIX: Superuser privileges

Storage directory

In Windows:

JP1/AJS3 - Manager-installation-folder\bin

In UNIX:

/opt/jplajs2/bin/

Arguments

-F *service-name*

Specify the name of a scheduler service for which units that will undergo a definition pre-check are defined.

You can specify a string of 1 to 30 bytes.

If you omit this option, the default is the value of environment variable `AJSCONF`. If environment variable `AJSCONF` has not been set, the name of the default scheduler service is assumed.

When specifying the scheduler service name for the logical host, you need to specify the logical host name in environment variable `JP1_HOSTNAME`.

If environment variable `JP1_HOSTNAME` has not been set, the local host name is assumed.

-s

Starts the execution of the definition pre-check.

-a

Outputs the execution status of the definition pre-check to the standard output file. The following table summarizes the names of execution statuses to be output:

| State of execution | Name of status to be output | Meaning |
|--------------------------|-----------------------------|--|
| Not yet executed | stop | <ul style="list-style-type: none">The definition pre-check can be executed.The definition pre-check result file has been updated. |
| Currently being executed | run | <ul style="list-style-type: none">The definition pre-check cannot be executed.The definition pre-check result file is being updated |

-O, -M, -C, -P, -H, -D, -U, -A

Specify the items you want to check in a definition pre-check.

You can specify more than one check item at the same time. The following table summarizes what each option actually checks and the order in which checks are made (the order shown is an example).

| Checking order | Option | Check item |
|----------------|--------|--|
| 1 | -O | Order of execution |
| 2 | -M | Detailed jobnet definition ^{#1} |
| 3 | -C | Execution agent restriction |
| 4 | -P | Empty job definition |
| 5 | -H | Execution agent name |
| 6 | -U | User mapping ^{#2} |
| 7 | -D | Detailed job definition |
| 8 | -A | Execution file privileges ^{#2} |

#1

For jobnets, the command also checks the connection relationship of each jobnet connector with the waiting-target units that are set in the wait conditions. For jobs, the command checks only the wait conditions in the detailed jobnet definition.

#2

If you use the execution-user fixing function, this item is checked for the fixed JP1 user as defined in the unit-attribute profile.

The command checks in the order of the options shown in the table, regardless of the order in which you specify the options. If the -D option (detailed job definition) or -A option (execution file privileges) is specified, the user mapping will also be checked as a precondition because information about the OS user that executes the job is required. If the -P, -H, -U, -D, or -A options (corresponding to 4 to 8 in the Checking order column) are specified to be checked by the agents, the execution agent name will also be checked as a precondition.

By default, all options (-O, -M, -C, -P, -H, -U, -D, -A) are assumed.

None of these options can be specified together with the -a option.

-p *execution-agent-profile-name*

When checking execution agent restriction, specify the applicable execution agent profile using an absolute path.

You can specify a character string of 1 to 255 bytes.

If the folder you specify contains spaces, enclose the entire path in double quotation marks (").

You can specify this option together with the `-C` option. If you specify the `-C` option but omit this option, the execution agent profile for the scheduler service specified in the `-F` option applies.

`-e` *unit-attribute-profile-name*

When checking the execution-user fixing function, specify the applicable unit-attribute profile using an absolute path.

You can specify a character string of 1 to 255 bytes.

If the folder you specify contains spaces, enclose the entire path in double quotation marks (").

You can specify this option together with the `-U`, `-D`, or `-A` option. If you specify the `-U` option but omit this option, the system assumes the unit attribute profile for the scheduler service specified in the `-F` option. If you omit the `-F` option, the system assumes the unit attribute profile for the default scheduler service.

`-u` *registered-user-name*

Specify the JP1 user for which the jobnet is actually registered in actual operation.

You can specify a string of 1 to 31 bytes.

When the job definition has a registered user in its execution-user type, the specified JP1 user performs the user mapping check.

By default, the user executing this command is assumed.

This option cannot be specified together with the `-a` option.

`-o` *output-file-name*

Using an absolute path, specify the pre-check result file name. See *Output example* for the format of the pre-check result file name.

You can specify a string of 1 to 255 bytes.

An overwrite is performed if there is a file whose name is the same as that of the specified output file.

An error occurs if there is no directory path.

If you omit this option, the default is the file name specified in the environment variable parameter `AJSCHK_CHECKFILE`. If the `AJSCHK_CHECKFILE` environment setting parameter is not specified, the default value for the `AJSCHK_CHECKFILE` is assumed.

For details on the `AJSCHK_CHECKFILE` environment setting parameter, see *20.7.2(1) AJSCHK_CHECKFILE* in the *JP1/Automatic Job Management System 3 Configuration Guide*.

This option cannot be specified together with the `-a` option.

`-R`

Treats all jobnets or jobs under the specified unit as subject to the definition pre-check (pre-check starting point). If this option is specified together with the `-L`, `-T`, `-N`, or `-J` option, the applicable jobnets and jobs are subject to the definition pre-check (check starting point) according to the specification of each option.

To check all jobnets and jobs under a job group, specify this option together with the `-T` option.

This option cannot be specified together with the `-a` option.

-L

Performs a definition pre-check on unregistered jobnets and jobs.

If you specify this option together with the `-T`, `-N`, or `-J` option, a definition pre-check is performed on unregistered jobnets according to the definition of each option.

This option cannot be specified together with the `-a` option.

-T

Performs a definition pre-check on the root jobnet.

You cannot specify this option together with the `-a` or `-J` option.

-N

Performs a definition pre-check on jobnets.

You cannot specify this option together with the `-a` or `-J` option.

-J

Performs a definition pre-check on jobs.

You cannot specify this option together with the `-a`, `-T`, or `-N` option.

job-name, jobnet-name-or-job-group-name

Specify the job, jobnet, or job group for which you are to perform a definition pre-check.

A definition pre-check starts with the units immediately under the specified unit.

You can specify a string of 1 to 930 bytes.

You can specify multiple jobs, jobnets, or job groups. You can also specify the root job group (/). Note that you must specify the `-R` option if you specify a job group name.

Note that a job, jobnet, or job group cannot contain the logical host name, scheduler service name, or execution ID.

This option cannot be specified together with the `-a` option.

Notes

- Make sure that you perform a definition pre-check while no jobs are running. If you perform a definition pre-check while a job is running, the following problems might occur:
 - Performance of job execution is affected by contention of access to the scheduler database.
 - An error occurs in job execution processing because the load on the system becomes temporarily heavy.
- You cannot use this command to start a new definition pre-check while another definition pre-check is being performed. If you want to perform multiple definition pre-checks, make sure that a definition pre-check is not being performed, and then execute this command with the `-a` option specified.

- If the JP1/AJS3 Check Manager service has not been started, this command terminates abnormally. The check process does not work with an agent for which the JP1/AJS3 Check Agent service has not started, but continues with other agents for which the JP1/AJS3 Check Agent service has started.
- If you perform a definition pre-check while the JP1/AJS3 service is not running on the manager side, the pre-check result might not be output correctly.
- Do not attempt to add or delete target units (including the units under the particular directory path) or change the content of definitions while a definition pre-check is underway. Doing so may prevent the check results from being output properly.
- While a definition pre-check is being performed, do not change the execution agent settings specified for the units (including subordinate units) being checked. If you change these settings, the pre-check result might not be output correctly.
- If any non-target unit is specified, you will not see any message saying that the unit has been skipped.
- If you specify the `-R` option, the specified unit and the units under the particular directory path undergo a pre-check. In this case, each unit is checked more than once because the target units are checked repeatedly on a layer basis.
- If you specify the `-R` option, the execution agent name for the upper-level jobnet is assumed for the jobs to be checked, regardless of the definition of the job execution agent name. To perform a definition pre-check without the execution agent name being assumed for the upper-level unit as the job execution agent name, specify the `-R` option together with the `-T` or `-N` option.
- If you specify the `-R` option to check the execution order of the jobs for the pre-check, only the order of the jobs is checked. Accordingly, if you specify the `-R` option and perform a pre-check of a judgment job subject to checking, an error message indicating that a dependent job has not been defined for a judgment job might appear even when the judgment job has a dependant. In such cases, perform a pre-check of the definition by specifying the jobnet either without specifying the `-R` option, or else with the `-R` option specified together with the `-T` option or the `-N` option.
- Using the `-a` option to examine the state of operation while a large number of units are being checked may take some time before the result is displayed.
- Delete the `JP1_HOSTNAME` environment variable before performing a definition pre-check on units of the physical host.
- If the check results are not output, read the Hitachi integrated log and take corrective action according to what it says.
- If you perform a definition pre-check on a unit for which an irresolvable host name is specified for **Exec-agent** in the detailed unit definition, output of the definition pre-check result file takes a long time.
- If you perform a definition pre-check on a jobnet connector and its connection-destination jobnet, specify the jobnet connector as the target of the definition pre-check.
- The system does not perform a definition pre-check of any macro variable names you specify.
- The checks performed by the `-D` option (detailed job definition) and the `-A` option (execution file privileges) for a Unix job assume that the user mapping check result is normal. If the user mapping check returns an error, the detailed job definition check and execution file privileges check will be performed assuming that the job execution user is an OS user that has superuser privileges (that is, a root user). Therefore, the checks will not be performed correctly if the user mapping check result fails and the job execution OS user is not a root user. If the job execution OS user is not a root user, you must correct the user mapping error, and then re-execute the detailed job definition check and execution file privileges check.
- Do not use an alias for the agent host name of a target job. If an alias for the agent host name of a target job is used, the pre-check result might not be output correctly.
- The function enabled by the `-O` (execution order) option checks whether there are correlated units that are defined so that their execution order relationships result in a loop. This function neither identifies the locations where a loop occurs nor checks for all units where loops exist.

Return values

| | |
|---------------------|--------------|
| 0 | Normal end |
| Values other than 0 | Abnormal end |

Example

In this example, the command below executes a definition pre-check under the following conditions:

- The registered user name is USER1 .
- The command checks all unregistered jobs under the /GROUP1/NET1 directory path.
- The command specifies all the check conditions.

```
ajschkdef -F AJSROOT1 -s -u USER1 -RLJ /GROUP1/NET1
```

Output example

The following shows an example of the command output resulting from a definition pre-check performed under the above conditions. In this example, missing execution agent information is detected on the Manager in /GROUP1/NET1/JOB1, an empty job definition is detected for /GROUP1/NET1/JOB2, and an error related to execution agent permission was detected for /GROUP1/NET1/JOB3.

```
(1) CHECKUNIT=/GROUP1/NET1
(2) CHECKSERVICE=AJSROOT1
(3) CHECKAGTPROFNAME=C:\Temp\profile1.txt
(4) CHECKUSER=USER1
(5) CHECKUNITPROFNAME=C:\Temp\profile.txt
(6) CHECKOPT=-O,-C,-P,-H,-D,-U,-A,-R,-L,-J
(7) CHECKSTARTTIME=20XX/10/01 14:30:00
(8)
(9) JOB1,/GROUP1/NET1/,The exec-agent has not been registered on the Manager side.,
    EXEC_AGENT=agt1
    JOB2,/GROUP1/NET1/,The script file or executable file or event ID is not specified.
    JOB3,/GROUP1/NET1/,The specified exec-agent is not enabled on the exec-agent profile.,
    EXEC_AGENT=agt2
(10)
(11) CHECKENDTIME=20XX/10/01 14:30:01
(12) NUMBER OF CHECKUNITS=4/4, NUMBER OF ERRORS=3
```

Explanation of output items

(1) CHECKUNIT=*full-unit-name* [, *full-unit-name* . . .]

The unit name specified when the definition pre-check was performed is output in *full-unit-name* form. If you specified multiple names, all of them are output, with a comma inserted between them.

(2) CHECKSERVICE=*scheduler-service-name*

The scheduler service name specified when the definition pre-check was performed is output.

(3) CHECKAGTPROFNAME=*execution-agent-profile-name*

The execution agent profile name specified when the definition pre-check was performed is output. This field is blank if execution agent profiles are disabled.

(4) CHECKUSER=*registered-user-name*

The *registered-user-name* specified when the definition pre-check was performed is output.

(5) CHECKUNITPROFNAME=*unit-attribute-profile-name*

The unit-attribute profile name specified when the definition pre-check was performed is output. This field is blank if the execution-user fixing function is disabled.

(6) CHECKOPT=*specified-option*

The options (-O/-M/-C/-P/-H/-D/-U/-A/-R/-L/-T/-N/-J) specified when the definition pre-check was performed are output, with a comma inserted between them.

(7) CHECKSTARTTIME=*execution-start-date*

The date and time at which the definition pre-check was performed are output in the form
YYYY/MM/DD hh:mm:ss.

(8) Empty lines

(9) Check result information (unit name, path name, error category, error details)

After the definition pre-check is performed, information about the check result is output in list form. The units involving errors are listed, with a comma inserted between them.

unit-name

The unit name of a unit that showed an error in the check is output.

path-name

The path name (the full parent unit name) of a unit that showed an error in the check is output.

error-category

The category of an error that was detected in the check is output.

See the following table for the categories of errors that are output.

error-details

The details of an error (classified by error category) that was detected in the check are output.

The following table gives details about output errors.

| Check item specified at startup | Error category | Error detail |
|---------------------------------|---|--|
| Order of execution | The execution order is looped in the relation definitions. | <ul style="list-style-type: none">For 08-10 and earlier: (none)For 08-50 and later: unit=<i>unit-name</i>^{#1} |
| | A dependent job has not been defined for a judgment job. | <ul style="list-style-type: none">For 08-10 and earlier: (none)For 08-50 and later: unit=<i>unit-name</i>; <i>unit-name</i>; . . .^{#2} |
| | A relation definition other than a conditional connection has been defined for a dependant job. | <ul style="list-style-type: none">For 08-10 and earlier: (none)For 08-50 and later: unit=<i>unit-name</i>; <i>unit-name</i>; . . .^{#3} |
| Execution agent name | The host name of the Manager cannot be resolved from the Agent side. | MANAGER_HOST= <i>manager-host-name</i> |

| Check item specified at startup | Error category | Error detail |
|---------------------------------|--|--|
| Execution agent name | The host IP address of the Manager cannot be resolved from the Agent side.#4 | MANAGER_IP= <i>manager-host-IP-address</i> |
| | The execution-agent has not been registered on the Manager side. | EXEC_AGENT= <i>execution-agent-name</i> |
| | The target host name cannot be resolved from the Manager side. | AGENT_HOST= <i>execution-host-name</i> |
| Detailed jobnet definition | The specified connection range is different from the jobnet for the connection-destination. | unit= <i>connection-destination-jobnet-name</i> #5 |
| | Cannot connect to the specified host. | nchn= <i>connection-host-name</i> |
| | Specified Scheduler service not exist. | ncsv= <i>connection-service-name</i> |
| | Jobnet name for the connection-destination is not specified. | (none) |
| | The specification of jobnet for the connection-destination is not collect. | ncr= <i>connection-destination-jobnet-name</i> |
| | The jobnet for the connection-destination is not configured for controlling the execution order. | unit= <i>connection-destination-jobnet-name</i> #5 |
| | Cannot connect with the connection host name specified in the jobnet for the connection-destination. | unit= <i>connection-destination-jobnet-name</i> #5 |
| | The connection service name specified in the jobnet for the connection-destination is incorrect. | unit= <i>connection-destination-jobnet-name</i> #5 |
| | The jobnet connector name specified at jobnet for the connection-destination is wrong. | unit= <i>connection-destination-jobnet-name</i> #5 |
| | Specified unit whose end is being waited for does not exist. | unit= <i>unit-whose-end-is-being-waited-for</i> |
| | The specification of unit whose end is being waited for is not collect. | unit= <i>unit-whose-end-is-being-waited-for</i> |
| Detailed job definition | The specified file or directory does not exist. | sc= <i>script-file-name (execution-file-name)</i> ev= <i>environment-variable-file-name</i> wkp= <i>working-path-name</i> si= <i>standard-input-file-name</i> so= <i>standard-output-file-name</i> se= <i>standard-error-output-file-name</i> ts1= <i>transfer-source-file-name</i> td1= <i>transfer-destination-file-name</i> ts2= <i>transfer-source-file-name</i> td2= <i>transfer-destination-file-name</i> ts3= <i>transfer-source-file-name</i> td3= <i>transfer-destination-file-name</i> ts4= <i>transfer-source-file-name</i> td4= <i>transfer-destination-file-name</i> |

| Check item specified at startup | Error category | Error detail |
|---------------------------------|---|---|
| Detailed job definition | You do not have permission to access the specified file or directory. | <i>sc=script-file-name (execution -file-name)</i> <i>ev=environment-variable-file-name</i> <i>wkp=working-path-name</i> <i>si=standard-input-file-name</i> <i>so= standard-output-file-name</i> <i>se= standard-error-output-file-name</i> <i>ts1=transfer-source-file-name</i> <i>td1=transfer-destination-file-name</i> <i>ts2=transfer-source-file-name</i> <i>td2=transfer-destination-file-name</i> <i>ts3=transfer-source-file-name</i> <i>td3=transfer-destination-file-name</i> <i>ts4=transfer-source-file-name</i> <i>td4=transfer-destination-file-name</i> |
| | The specified platform type is invalid. | <i>pfm=platform-type</i> |
| | The format of the value specified for the event ID is invalid. | <i>evwid=event-ID</i> |
| | The value specified for "Find event before exec." is outside the valid range. | <i>Evesc=pre-search-time</i> |
| | The format of the name of the file to be monitored is invalid. | <i>flwf=monitoring-target-file-name</i> |
| User mapping ^{#6} | The specified user mapping is invalid. | <i>JP1_USER=JP1-user-name</i> |
| | Mapping of an execution host is invalid. | <i>JP1_USER=JP1-user-name</i> |
| | Mapping of a OS user is invalid. | <i>OS_USER=OS-user-name</i> |
| | The specified user does not exist. | <i>un=execution-user-name</i> |
| Execution file privileges | You do not have permission to execute the specified script file or executable file. | <i>JP1_USER=JP1-user-name</i> <i>FILE_AUTH=file-privilege^{#7}</i> |
| Empty job definition | The script file or executable file or event ID is not specified. | (None) |
| Execution agent restriction | The specified exec-agent is not enabled on the exec-agent profile. | <i>execution-agent-name</i> |

#1

Only one unit name is output for units whose execution order is looped in the relation definitions.

#2

The names of judgment jobs for which dependent units are not defined by using conditional relations are output. If there are multiple errors, all unit names separated with a semicolon (;) are output.

#3

The names of dependent units that have relation definitions other than conditional relations are output. If there are multiple errors, all unit names separated with a semicolon (;) are output.

#4

This error is output if NAT (network address translation) is used for communication between agents and the manager because the IP address resolved from the manager host name is different for the agent hosts and the manager host. Ignore this error if there are no problems with the settings.

#5

If **Other service** is specified for **Connection range**, *host-name:scheduler-service-name:unit-name* is output.

#6

If the user mapping check fails, the **-D** option (detailed job definition) check and the **-A** option (execution file privileges) check are performed assuming that the job execution user is an OS user that has superuser privileges (that is, a root user). Therefore, if the job execution user is not a root user, correct the user mapping error, and then re-execute the detailed job definition check and execution file privileges check.

#7

For details about file privileges, see the following table.

File privileges are output in the same way as in the **chmod** command. (Example: 0644)

| Access permission type | Value | Explanation |
|---------------------------|-------|---|
| Special access permission | 1000 | Swap is maintained in the program code. |
| | 2000 | The group ID is set during execution. |
| | 4000 | The user ID is set during execution. |
| User with the same UID | 100 | Execution |
| | 200 | Writing |
| | 400 | Reading |
| Group with the same GID | 10 | Execution |
| | 20 | Writing |
| | 40 | Reading |
| Other user | 1 | Execution |
| | 2 | Writing |
| | 4 | Reading |

(10) Empty lines

(11) CHECKENDTIME=*execution-end-date*

The date and time when the definition pre-check ended is output in the form *YYYYH/MM/DD hh:mm:ss* form.

(12) NUMBER OF CHECKUNITS=*number-of-checked-units / number-of-units-subject-to-checking*, NUMBER OF ERRORS=*number-of-items-for-which-an-error-was-detected*

Summary information for the result of a definition pre-check is output. This information includes the number of checked units and the number of items for which an error was detected. If no error was detected, 0 is output.

If you specify the **-O** or **-M** option, jobnets and jobnet connectors are also counted as checked units. If you specify any of the **-C**, **-P**, **-H**, **-U**, **-D**, or **-A** options, jobs are also counted.

The number of units subject to checking might be different from the number of checked units in the following case:

- A definition pre-check process error occurred during checking.
If a definition pre-check process error occurred during checking, the error message is output to the integrated trace log.
- The connection source restriction function refused connection to the checked units.
If the units to be checked are jobnet connectors with their **Connection range** set to **Other service** and the source restriction function is enabled on the destination host, the number of checked units will be reduced by the number of units whose connection was denied.

If an error occurred during the check, the error details are output to the integrated trace log. If different machines are being used for the JP1/AJS3 - Manager and the JP1/AJS3 - Agent, check the integrated trace log in the manager machine first. If no errors are found, check the integrated log in the agent machine.

Items (1) to (7) (information about the definition pre-check) and items (11) and (12) (execution end date and summary information) are output only once each time the command is executed. Item (9) (check results) is output for all error occurrences that were detected.

ajschkstart (UNIX only)

Format

In JP1/AJS3 - Manager:

```
ajschkstart
  [-m]
  [-a]
```

In JP1/AJS3 - Agent:

```
ajschkstart
  [-a]
```

Description

Starts the JP1/AJS3 Check Manager service or the JP1/AJS3 Check Agent service.

Execution privileges

Superuser privileges

Storage directory

/opt/jp1ajs2/bin/

Arguments

-m

Starts the JP1/AJS3 Check Manager service.

-a

Starts the JP1/AJS3 Check Agent service.

Return values

| | |
|---------------------|--------------|
| 0 | Normal end |
| Values other than 0 | Abnormal end |

Notes

- This command applies only to UNIX. You cannot use this command in Windows.
- If you omit all options, the following options are assumed:
 - JP1/AJS3 - Manager: -m, -a
 - JP1/AJS3 - Agent: -a

Additional information

In Windows, start the service control manager first.

Example

In this example, the command starts, in JP1/AJS3 - Manager, the JP1/AJS3 Check Manager service and the JP1/AJS3 Check Agent service:

```
ajschkstart -m -a
```

ajschkstop (UNIX only)

Format

In JP1/AJS3 - Manager:

```
ajschkstop
  [-m]
  [-a]
```

In JP1/AJS3 - Agent:

```
ajschkstop
  [-a]
```

Description

Stops the JP1/AJS3 Check Manager service or the JP1/AJS3 Check Agent service.

Execution privileges

Superuser privileges

Storage directory

/opt/jp1ajs2/bin/

Arguments

-m

Stops the JP1/AJS3 Check Manager service.

-a

Stops the JP1/AJS3 Check Agent service.

Return values

| | |
|---------------------|--------------|
| 0 | Normal end |
| Values other than 0 | Abnormal end |

Notes

- This command applies only to UNIX. You cannot use this command for Windows.
- If you omit all options, the following options are assumed:
 - JP1/AJS3 - Manager: -m, -a
 - JP1/AJS3 - Agent: -a
- When a check is underway, processing is terminated without waiting for the check to end.
- If this command is used to stop the JP1/AJS3 Check Agent service, the command does it by communicating with the local host via TCP/IP according to the JP1/Base physical host communication settings. Therefore, if the IP address corresponding to the local host name (shown by the `hostname` command) can be used to communicate with another host, the command might stop the JP1/AJS3 Check Agent service on the other host.

If you execute the command in this environment, beforehand, set the `hosts`, `DNS`, `jplhosts`, or `jplhosts2` file so that the local host name can resolve into the local host IP address.

For details about the `jplhosts` or `jplhosts2` file, see the *JP1/Base User's Guide*.

Additional information

In Windows, stop the service control manager first.

Example

In this example, the command stops, in JP1/AJS3 - Manager, the JP1/AJS3 Check Manager service and the JP1/AJS3 Check Agent service:

```
ajschkstop -m -a
```

ajschktrsetsz

Format

```
ajschktrsetsz  
  [-s size]
```

Description

Changes the size of the trace log file for the JP1/AJS3 Check Manager service or the JP1/AJS3 Check Agent service.

If you do not specify any arguments for execution, the currently set size of the trace log file is output to the standard output file.

Execution privileges

In Windows: Administrators privileges

In UNIX: Superuser privileges

Storage directory

In Windows:

JP1/AJS3 - Manager-installation-folder\bin

JP1/AJS3 - Agent-installation-folder\bin

In UNIX:

/opt/jp1ajs2/bin/

Arguments

-s size

Specifies the size of the trace log file.

You can specify a value of 64 to 2,097,151 kilobytes.

Notes

- If you use this command to reduce the size of a trace log file, the content of the original trace log file is deleted.
- Always separate the option and its value by at least one space character.

Example

In this example, the command reserves a value of 4,096 kilobytes for the size of the trace log file for the JP1/AJS3 Check Manager service or the JP1/AJS3 Check Agent service:

```
ajschktrsetsz -s 4096
```

ajscopy

Format

```
ajscopy
  [-F service-name]
  [-m permission-mode]
  [-c | -v]
  [-S]
  [-R]
  [-L | -E]
  [-T]
  [-G | -N | -J]
  -o output-destination-unit-name
  input-source-unit-name...
```

Description

Copies, moves or renames units.

When you copy a unit defined under a unit with the upper-level unit-attribute inheritance function set, a function will set the owner and JP1 resource group of the copy. For details on this function, see *6.4.1(4)(a) Overview of the upper-level unit-attribute inheritance function* in the *JP1/Automatic Job Management System 3 System Design (Work Tasks) Guide*.

When you move or rename a unit, it retains the owner and JP1 resource group of the source unit.

Execution privileges

You must have any of the following JP1 privileges:

- JP1_AJS_Admin privilege
- JP1_AJS_Manager privilege
- JP1_AJS_Editor privilege
- JP1_AJS_Operator privilege (allows you to execute this command only for the copy target unit and its subunits)
- JP1_AJS_Guest privilege (allows you to execute this command only for the copy target unit and its subunits)

Arguments

-F *service-name*

Specify the name of the target scheduler service.

You can specify a character string of 1 to 30 bytes.

-m *permission-mode*

Specify the permission mode if you change the settings for the JP1 user for job execution before copying, moving, or renaming a jobnet.

You can specify a four-digit octal value.

The following is the meaning of each digit, starting from the left:

1st digit

Specify the handling of the user for job execution

0 to 3: Assumes the JP1 user who has registered the jobnet to be the user for job execution.

4 to 7: Assumes the JP1 user who owns the job to be the user for job execution.

2nd to 4th digits

Specifies any value between 0 and 7.

If you omit this option, the system assumes the same value as that for the source unit. This option is valid only if you define a job with the `-o` option.

-c

Copies the unit.

-v

Moves or renames the unit.

You cannot specify this option with the `-E` option.

-S

This option makes it possible to copy units under the particular jobnet, even for suspended jobnets that have been registered for execution. It is also possible to change the names of units that are added during the suspend operation. Even for suspended jobnets, however, you cannot copy or rename units in the following situation:

- While jobnets are being executed

-R

Assumes all job groups, jobnets, and jobs contained in the specified unit as the input source unit.

If you specify this option with the `-G`, `-N`, `-J`, `-L`, `-E`, and/or `-T` options, the system assumes the input source unit according to the specification of each option.

-L

Assumes the job groups, jobnets not registered for execution, and jobs as the input source unit.

You cannot specify this option with the `-G` option.

-E

Assumes the jobnets registered for execution and jobs as the input source unit.

You cannot specify this option with the `-v` or `-G` option.

-T

Assumes the root jobnet as the input source unit.

You cannot specify this option with the `-G` or `-J` option.

-G

Assumes job groups as the input source unit.

You cannot specify this option with the `-L`, `-E`, `-T`, `-N`, or `-J` option.

-N

Assumes jobnets as the input source unit.

You cannot specify this option with the `-G` or `-J` option.

If you specify this option with the `-T` option, this option is disabled.

-J

Assumes jobs as the input source unit.

You cannot specify this option with the `-G`, `-N`, or `-T` option.

-o *output-destination-unit-name*

Specify the name of the unit to which you want to copy, move, or rename the unit.

You can specify a character string of 1 to 930 bytes.

When copying or moving:

If you specify an existing job group name or jobnet name, the system copies or moves the unit into that unit.

When renaming:

You cannot specify an existing job name, manager job group name, manager jobnet name.

Note that you cannot specify a logical host name, scheduler service name, or execution ID as *output-destination-unit-name*.

input-source-unit-name

Specify the name of the unit from which you want to copy, move, or rename the unit.

You cannot specify the start condition unit as *input-source-unit-name*.

You can specify a character string of 1 to 930 bytes.

You cannot specify a logical host name or execution ID as the input source unit.

Notes

- Either of the following users can copy a unit:
 - A user granted the reference privilege for the unit copy source (and all subordinate data) and the update privilege for the copy destination
 - A JP1 user mapped to the OS user who has Administrators or superuser privileges
Note, however, that if `YES` is set after changing the `ADMACLIMIT` environment setting parameter from its default, even a JP1 user who was mapped to an OS user with Administrators or superuser privileges must have the reference privilege and the update privilege.
- Any of the following users can move or rename a unit:
 - A user granted the update privilege for the source and destination units
 - A user granted the update privilege for the unit to be renamed
 - A JP1 user mapped to the OS user who has Administrators or superuser privileges

Note, however, that if `yes` is set after changing the `ADMACLIMIT` environment setting parameter from its default, even a JP1 user who was mapped to an OS user with Administrators or superuser privileges must have the update privilege.

Common notes on copying, moving, and renaming:

- If the unit (other than job groups) specified as the name of the output destination unit or name of the input source unit is currently open, this command terminates abnormally.
- You cannot move or rename a unit containing a registered jobnet (other than remote jobnets) or a unit contained in such a registered jobnet. You cannot copy or move a unit into a registered jobnet. For units other than remote jobnets, however, specifying the `-s` option in this command while keeping the target jobnet suspended allows you to copy a unit to the target jobnet or rename an additional unit without having to cancel the registration of the jobnet.
- You cannot assign the same name to both the input source unit and the output destination unit.
- You must assign a new unit name to the output destination unit. (If you use any existing unit name, the target unit will move into the existing output destination unit.) With more than one input source unit specified, however, you cannot give a new unit name to the output destination name.
- This command terminates abnormally if a unit specified in the name of the output destination unit or a unit specified in the name of the input source unit is undergoing a suspended-stage change.

Copying and moving

- You cannot copy or move a job group into a jobnet.
- If an error occurs while the system is copying a unit, it deletes the unit that has been partly copied. This command terminates abnormally.
- You cannot copy or move a planning group into a jobnet.
- You cannot copy or move any unit other than a jobnet or remote jobnet into a planning group.
- You cannot move or rename a planning group containing a registered root jobnet.
- If you copy or move as a root jobnet a root jobnet that is a jobnet to which a jobnet connector is connected, execution order control information such as the jobnet connector name is also copied or moved. On the other hand, if you copy or move the root jobnet as a nested jobnet, the definition information is reset to the default status (execution order control is disabled).
- If you copy or move the planning group defined as the jobnet to which a jobnet connector is to be connected, the execution order control information such as the jobnet connector name is also copied or moved.
- If you attempt to copy a release target jobnet (root jobnet for which release entry is made), the jobnet definitions in *Being applied* status are copied. If you attempt to move a release target jobnet, definitions of all jobnets for which release entry is made are moved.
- You cannot copy or move jobnet connectors or start conditions so that they are under a release target jobnet (root jobnet for which release entry is made).
- If you copy or move an execution interval control job that is defined for immediate completion after the job has been started, from start conditions to a normal jobnet, the job settings are changed. The job is no longer set for immediate completion after the job has been started.

Return values

| | |
|--|--------------|
| 0 | Normal end |
| Multiple of 4 within the range from 4 to 124 | Abnormal end |

Additional information

Units that have been copied or moved are automatically located in an empty space on the Jobnet Editor window in JP1/AJS3 - View (somewhere from the top left to the bottom right).

Example

The following command copies jobnet net1 into job group grp1:

```
ajscopy -c -o grp1 net1
```

ajsdefine

Format

```
ajsdefine
  [-F service-name]
  [-S]
  [{-x|-t}]
  [{-i|_e|-f}]
  [-p]
  [-d destination-unit-name]
  [unit-definition-file-name...]
```

Description

Defines a unit based on the parameters coded in a unit definition file.

For details about a unit definition file, see [5.1 Creating a unit definition file](#).

If you define a unit under a unit for which the upper-level unit-attribute inheritance function is set, a function will set the owner and JP1 resource group of the defined unit. For details on this function, see [6.4.1\(4\)\(a\) Overview of the upper-level unit-attribute inheritance function](#) in the *JP1/Automatic Job Management System 3 System Design (Work Tasks) Guide*.

Execution privileges

You must have any of the following JP1 privileges:

- JP1_AJS_Admin privilege
- JP1_AJS_Manager privilege
- JP1_AJS_Editor privilege

Arguments

-F *service-name*

Specify the name of the target scheduler service.

You can specify a character string of 1 to 30 bytes.

-S

This option makes it possible to update the definitions of nested jobnets and jobs, even for suspended jobnets that have been registered for execution. Even for suspended jobnets, however, you cannot update definitions in the following situations:

- While the definition of the root jobnet is being updated
- While the definitions of job groups containing the definition of the root jobnet are being updated
- While jobnets are being executed

-x

Defines a unit based on the parameters coded in a unit definition file.

-t

Performs only a syntax check for the parameters coded in a unit definition file.

-i

Displays a message with a confirmation prompt if the definition destination contains a unit having the same name as the unit coded in the unit definition file. If you enter `y` for this prompt, the unit name is forcibly updated.[#] This option generates an error if the unit definition file contains the specification of units having the same name in the same layer.

#

Delete the unit to be forcibly updated and subordinate units, and then create a unit and code in the unit definition file.

-e

Generates an error without updating information, if the definition destination contains a unit having the same name as the unit coded in the unit definition file. This option generates an error if the unit definition file contains the specification of units having the same name in the same layer. The system does not update information.

-f

Forcibly updates[#] the unit if the definition destination contains a unit that has the same name as the unit coded in the unit definition. This option generates an error if the unit definition file contains the specification of units having the same name in the same layer.

#

Delete the unit to be forcibly updated and subordinate units, and then create a unit and code in the unit definition file.

-p

When the upper-level unit-attribute inheritance function is enabled, specify this option to ignore the unit-attribute profile when defining the unit.

Specify this option when you want to define units exactly as they appear in a unit definition file output by the `ajsprint` command.

-d *destination-unit-name*

Specify the name of the job group or jobnet in which you want to define the unit.

You can specify a character string of 1 to 930 bytes. You cannot specify the logical host name or execution ID. You cannot specify a job group or jobnet for which the number of nested units exceeds 30 (10 if the `DEFLENTYPE` environment setting parameter is set to `sjis`), the maximum allowed.

If this option is omitted, the root job group (`/`) is assumed, in which units will be created.

unit-definition-file-name

Specify the name of the file in which you defined the unit definition parameters (attributes of the unit).

You can specify a character string of 1 to 255 bytes.

You can specify more than one unit definition file. You cannot use wildcard characters here.

If the coding of any unit definition file is invalid, the system stops processing that file but continues processing other files.

If you omit this option, the system inputs the unit definition parameters from the standard input.

Notes

- Either of the following users can define a unit:
 - A user granted the update privilege for the definition destination of the unit
 - A JP1 user mapped to the OS user who has Administrators or superuser privilegesNote, however, that if `yes` is set after changing the `ADMACLIMIT` environment setting parameter from its default, even a JP1 user who was mapped to an OS user with Administrators or superuser privileges must have the update privilege.
- If an error occurs while the unit is being defined, the unit is deleted and the command ends abnormally. When a unit is forcibly updated by specifying the `-i` or `-f` option, if an error occurs after the unit to be updated is defined, the unit is deleted and the command ends abnormally.
- If you forcibly update a job group or a jobnet by specifying the `-i` or `-f` option, the schedule for jobnet that references the forcibly updated job group is not recalculated. The schedule for jobnet for which the forcibly updated jobnet is specified in the exclusive schedule is also not recalculated.
- If you forcibly update a unit by specifying the `-i` or `-f` option, the following jobnets that are registered for planned execution or for fixed execution for a specified number of future generations might be placed in Shutdown status or their execution schedules might not be created:
 - Jobnets for which the job group to be updated is specified in *Refer to the calendar of another job group* option
 - Jobnets for which the jobnet to be updated is specified in *Exclusive schedule* option

To prevent this, perform either of the following operations:

- Cancel the registration of the jobnets mentioned in 1 or 2 above, and then execute the `ajsdefine` command with the `-i` or `-f` option specified.
- Change the unit definition by using the `ajscalendar`, `ajschange`, or `ajschgnet` command, not by using the `ajsdefine` command.
- If the jobnet specified for *destination-unit-name* is in either of the following states, this command terminates abnormally:
 - The jobnet is registered for execution, and is not in the suspend status.
 - The jobnet has been edited exclusively by JP1/AJS - View.
- You cannot define a job group in a jobnet.
- You cannot define a unit in a job, manager job group or manager jobnet.
- You cannot update information about a root jobnet registered for execution or information about any job group or planning group containing that root jobnet.
- For a jobnet registered for execution, you cannot define a unit in the jobnet or in its upper-level or lower-level unit.
- In the following units, however, specifying the `-s` option in this command while keeping the target jobnet suspended allows you to specify information without having to cancel the registration of the jobnet: units in the root jobnet, those in the job groups containing the root jobnet, and those in other than remote jobnets. (If the target unit is currently being executed, specifying the `-s` option will not allow you to update the information.)
- You cannot define a planning group in a jobnet.
- You cannot define any unit other than a jobnet or remote jobnet in a planning group.
- If you use the command to define a jobnet, the system does not check the consistency of the execution order of units. A jobnet in which units will result in a loop or a judgment job without any associated dependent units results in an error and is placed in *Invalid exe. seq.* status.

- If you attempt to define a unit in a release target jobnet (root jobnet for which release entry is made), the definition of the unit is added to the jobnet definitions in *Being applied* status.
- You cannot define jobnet connectors or start conditions in release target jobnets (root jobnets for which release entry is made).
- If a unit definition file is large, the command might abnormally terminate due to insufficient memory. If this happens, split the file so that each part is less than 200 MB.

Return values

| | |
|--|--------------|
| 0 | Normal end |
| Multiple of 4 within the range from 4 to 124 | Abnormal end |

Additional information

If the window position is not specified for units to be defined, they are automatically located in an empty space on the Jobnet Editor window in JP1/AJS3 - View (somewhere from the top left to the bottom right).

Example

The following command defines a unit in job group `/group1` based on the parameters coded in unit definition file `/tmp/unit_def`:

```
ajsdefine -d /group1 /tmp/unit_def
```

ajsdelete

Format

```
ajsdelete
  [-F service-name]
  [-i]
  [-S]
  [-R]
  [-L]
  [-T]
  [-G|-N|-J]
  job-name-or-jobnet-name-or-job-group-name...
```

Description

Deletes a unit. This command guarantees consistency in the relationship even if you delete a jobnet or job for which you have made a relationship with other elements.

Execution privileges

You must have any of the following JP1 privileges:

- JP1_AJS_Admin privilege
- JP1_AJS_Manager privilege
- JP1_AJS_Editor privilege

Arguments

-F *service-name*

Specify the name of the target scheduler service.

You can specify a character string of 1 to 30 bytes.

-i

Displays a message with a confirmation prompt before deleting a unit.

-S

This option makes it possible to delete nested jobnets and jobs, even for suspended jobnets that have been registered for execution. Even for suspended jobnets, however, you cannot delete definitions in the following situations:

- While deleting the root jobnet
- While deleting the job group containing the root jobnet
- While jobnets are being executed

-R

Deletes all units in the specified job group or jobnet, according to the other specified options.

If you specify this option with the `-L`, `-T`, `-G`, `-N` and/or `-J` options, the system deletes the unit according to the specification of each option.

-L

Deletes job groups, jobnets not registered for execution, and jobs.

If you specify this option with the `-T`, `-N`, and/or `-J` options, the system deletes unregistered jobnets according to the specification of each option. You cannot specify this option with the `-G` option.

-T

Deletes root jobnets.

If you specify this option with the `-L` option, the system deletes root jobnets according to the specification of the `-L` option. If you specify this option with the `-N` option, the `-N` option is disabled. You cannot specify this option with the `-G` or `-J` option.

-G

Deletes job groups.

You cannot specify this option with the `-L`, `-T`, `-N`, or `-J` option.

-N

Deletes jobnets and recovery jobnets.

If you specify this option with the `-L` option, the system deletes jobnets and recovery jobnets according to the specification of the `-L` option. If you specify this option with the `-T` option, the `-N` option is disabled. You cannot specify this option with the `-G` or `-J` option.

-J

Deletes jobs.

You cannot specify this option with the `-T`, `-G`, or `-N` option.

job-name-or-jobnet-name-or-job-group-name

Specify the name of the job, jobnet or job group you want to delete.

You can specify a character string of 1 to 930 bytes.

You can specify more than one job, jobnet, or job group name. You cannot, however, specify the root job group (/).

You cannot specify a logical host name or execution ID as a job, jobnet or job group name.

Notes

- Either of the following users can delete a unit:
 - A user granted the update privilege for the unit to be deleted
 - A JP1 user mapped to the OS user who has Administrators or superuser privileges
Note, however, that if `yes` is set after changing the `ADMACLIMIT` environment setting parameter from its default, even a JP1 user who was mapped to an OS user with Administrators or superuser privileges must have the update privilege.
- For units other than in the root jobnet, the job group containing the root jobnet, and the remote jobnet, however, specifying the `-s` option in this command while keeping the target jobnet suspended makes it possible to conduct

the delete process without having to cancel the registered jobnet. (If the target unit is being currently executed, the delete process is not effective even if the `-s` option is specified.)

- If you attempt to delete a release target jobnet (root jobnet for which release entry is made), the definition of all jobnets for which release entry is made is deleted. If you attempt to delete a unit in a root jobnet for which release entry is made, the jobnet definitions in *Being applied* status are deleted.
- This command terminates abnormally if the target jobnet or job is undergoing a suspended-state change.

Return values

| | |
|--|--------------|
| 0 | Normal end |
| Multiple of 4 within the range from 4 to 124 | Abnormal end |

Example

The following command deletes only unregistered jobnets among the units contained in job group `/group1`, after displaying a prompt for confirmation:

```
ajsdelete -iRLN /group1
```

ajsembdbaddarea

Format

```
ajsembdbaddarea
  -r {table|index|table2|index2}
  -s embedded-database-file-system-area-size
  [-id embedded-database-setup-ID]
  -d name-of-directory-where-database-area-to-be-expanded-stored
```

Format1 (for expanding the tablespace AJS2DATA)

```
ajsembdbaddarea
  -r table
  -s embedded-database-file-system-area-size
  [-id embedded-database-setup-ID]
  -d name-of-directory-where-database-area-to-be-expanded-stored
```

Format2 (for expanding the index area AJS2INDX)

```
ajsembdbaddarea
  -r index
  -s embedded-database-file-system-area-size
  [-id embedded-database-setup-ID]
  -d name-of-directory-where-database-area-to-be-expanded-stored
```

Format3 (for expanding the tablespace AJS2DATA2)

```
ajsembdbaddarea
  -r table2
  -s embedded-database-file-system-area-size
  [-id embedded-database-setup-ID]
  -d name-of-directory-where-database-area-to-be-expanded-stored
```

Format4 (for expanding the index area AJS2INDX2)

```
ajsembdbaddarea
  -r index2
  -s embedded-database-file-system-area-size
  [-id embedded-database-setup-ID]
  -d name-of-directory-where-database-area-to-be-expanded-stored
```

Description

The `ajsembdbaddarea` command expands the embedded database area (tablespace or index area).

You can execute this command only when the embedded database is running.

You can execute the command regardless of the operating status of JP1/AJS3.

Execution privileges

In Windows: Administrators privileges

In UNIX: Superuser privileges

Storage directory

In Windows:

```
JP1/AJS3 - Manager-installation-folder\tools\
```

In UNIX:

```
/opt/jp1ajs2/tools/
```

Arguments

-r table | index | table2 | index2

Specifies the type of database area to be expanded.

- **table**
Expands the tablespace AJS2DATA.
- **index**
Expands the index area AJS2INDX.
- **table2**
Expands the tablespace AJS2DATA2.
Do not specify this option if the backup enhancement function is disabled.
- **index2**
Expands the index area AJS2INDX2.
Do not specify this option if the backup enhancement function is disabled.

-s embedded-database-file-system-area-size

Specify in MB the size of the file system area in the embedded database to be allocated.

You can specify a value in the range from 1 to 2,047#.

#:

If you specified **table2** for the **-r** option, you can specify a value between 50 and 2,047 for the **-s** option.

-d name-of-directory-where-database-area-to-be-expanded-stored

Use 120 bytes or less to specify the name of the directory that stores the database area to be expanded. If you specify a non-existent directory, an error occurs.

Keep the following points in mind when you specify a directory name:

- Use a full path name to specify a directory name.
- If you want to specify a directory whose name contains spaces, enclose the entire path in double quotation marks ("").
- Do not specify a disk on a network drive.
- In a cluster system, specify a directory on the shared disk.
- Make sure that the amount of space specified in the **-s** option is available to the specified directory.

-id *embedded-database-setup-ID*

Specify the setup identifier that identifies the embedded database in the `_JFn` format (*n*: 0-9 or A-Z). The value specified in this argument must be the same as the value specified in the `-id` option of the `ajsembdbbuild` command.

If you want to operate an embedded database created by using the `jajs_setup`, `jajs_setup_cluster`, and `jajs_migrate` commands, use the `ajsembdbidlist` command to check the setup identifier of the embedded database. For details on the `ajsembdbidlist` command, see [ajsembdbidlist](#) in *2. Commands Used during Setup*.

If you omit this option, the system assumes `_JF0`.

Notes

- This command is implemented by a script. If you specify an excessively long character string or an invalid character string or value for an option, an unexpected error might occur. You must use the number of characters allowed for a character string or a value in the option as specified in the DBMS and JP1/AJS3 specifications.
- In a cluster system, execute this command on the executing host (the host specified for the `-eh` option of the `ajsembdbbuild` command).
- The table area and the index area can each be expanded a maximum of 15 times.
- Do not execute multiple `ajsembdbaddarea` commands for a single embedded database.

Return values

| | |
|---------------------|--------------|
| 0 | Normal end |
| Values other than 0 | Abnormal end |

Additional information

When this command is executed, a file whose name is in the following format is created in the directory specified for the `-d` option:

`ajsRRRRRRRIIIYYYYMMDDhhmmss`

- RRRRRR: Type of expanded resource (value specified for the `-r` option)
- IIII: embedded database setup ID (value specified for the `-id` option)
- YYYY: year
- MM: month
- DD: day
- hh: hours
- mm: minute
- ss: second

Example:

The following shows an example of the command line and the file created when the command is executed at 21:40:12 on June 1, 2010:

```
ajsembdbaddarea -r index -s 2000 -d K:\rdarea -id _JF0  
K:\rdarea\ajsindex_JF020100601214012
```

Actions to be taken if an error occurs

If a command error occurs, take the indicated action in the following table.

| Message | Cause | Action to be taken |
|------------|--|---|
| KAVS0996-E | The specified option contains an error. | Check the specification of the option. |
| KAVS2101-E | The embedded database is inactive. | Start the embedded database and then re-execute the command. |
| KAVS2102-E | The embedded database is being started or stopped. | Use the <code>ajsembdbstatus -s ust</code> command to check whether the embedded database is running and then re-execute the command. |
| KAVS2104-E | The embedded database is not set up. | Set up the embedded database and then re-execute the command. |
| KAVS2116-E | The specified option contains an error. | Check the option output in the message and then re-execute the command. |
| KAVS2117-E | An error occurred during execution of the command. | Check the message output in the maintenance information. |
| KAVS8404-E | The backup enhancement function is disabled. | Check the specification of the <code>-r</code> option and then re-execute the command. |

ajsembdbaddlog

Format

```
ajsembdbaddlog
  -s embedded-database-file-system-area-size
  -r {sys|spd}
  [-id embedded-database-setup-ID]
  -d name-of-directory-where-file-to-be-expanded-stored
  [-du name-of-directory-where-file-to-be-expanded-stored]
```

Format 1 (for expanding the system log file)

```
ajsembdbaddlog
  -s embedded-database-file-system-area-size
  -r sys
  [-id embedded-database-setup-ID]
  -d name-of-directory-where-file-to-be-expanded-stored
```

Format 2 (for expanding the sink point dump file)

```
ajsembdbaddlog
  -s embedded-database-file-system-area-size
  -r spd
  [-id embedded-database-setup-ID]
  -d name-of-directory-where-file-to-be-expanded-stored
```

Format 3 (for expanding the duplicated system log file)

```
ajsembdbaddlog
  -s embedded-database-file-system-area-size
  -r sys
  [-id embedded-database-setup-ID]
  -d name-of-directory-where-file-to-be-expanded-stored
  -du name-of-directory-where-file-to-be-expanded-stored
```

Format 4 (for expanding the duplicated sink point dump file)

```
ajsembdbaddlog
  -s embedded-database-file-system-area-size
  -r spd
  [-id embedded-database-setup-ID]
  -d name-of-directory-where-file-to-be-expanded-stored
  -du name-of-directory-where-file-to-be-expanded-stored
```

Description

The `ajsembdbaddlog` command expands the embedded database system file (system log file or sink point dump file).

You can execute this command only while the embedded database and all the scheduler services for which the applicable embedded database was created as the scheduler database are not running.

Execution privileges

In Windows: Administrators privileges

In UNIX: Superuser privileges

Storage directory

In Windows:

JP1/AJS3 - Manager-installation-folder\tools

In UNIX:

/opt/jplajs2/tools/

Arguments

-s *embedded-database-file-system-area-size*

Specify in MB the size of the file system area in the embedded database to be allocated.

The range of values that can be specified in this option varies depending on the value of the `-r` option.

If the `-r` value is `sys`:

1 to 2,047

If the `-r` value is `spd`:

1 to 1,024

-r `sys` | `spd`

Specify the type of system file to be expanded.

- `sys`
The system log file is expanded.
- `spd`
The sink point dump file is expanded.

-id *embedded-database-setup-ID*

Specify the setup identifier that identifies the embedded database in the `_JFn` format (*n*: 0-9 or A-Z). The value specified in this argument must be the same as the value specified in the `-id` option of the `ajsembdbbuild` command.

If you want to operate an embedded database created by using the `jajs_setup`, `jajs_setup_cluster`, and `jajs_migrate` commands, use the `ajsembdbidlist` command to check the setup identifier of the embedded database. For details on the `ajsembdbidlist` command, see [ajsembdbidlist](#) in *2. Commands Used during Setup*.

If you omit this option, the system assumes `_JF0`.

-d *name-of-directory-where-file-to-be-expanded-stored*

Use 120 bytes or less to specify the name of the directory that stores the file to be expanded. If you specify a non-existent directory, an error occurs.

Keep the following points in mind when you specify a directory name:

- Use a full path name to specify a directory name.

- If you want to specify a directory whose name contains spaces, enclose the entire path in double quotation marks ("").
- Do not specify a disk on a network drive.
- In a cluster system, specify a directory on the shared disk.
- Make sure that the amount of space specified in the `-s` option is available to the specified directory.

`-du` *name-of-directory-where-file-to-be-expanded-stored*

Specify this option when you duplicate the system files of the embedded database.

You need to specify a different directory from the directory specified in the `-d` option. Other items are the same as the `-d` option.

Notes

- This command is implemented by a script. If you specify an excessively long character string or an invalid character string or value for an option, an unexpected error might occur. You must use the number of characters allowed for a character string or a value in the option as specified in the DBMS and JP1/AJS3 specifications.
- Do not execute this command more than once in quick succession. If you do so, the following problems might occur:
 - The message output is invalid. For example, an invalid message is output or a message that should be output is not output.
 - The command results in an error.
- You can create a maximum of 30 system log files and a maximum of 30 sink point dump files. When you create the first embedded database environment, 12 system log files are created by default and you can add up to 18 system log files. Three sink point dump files are also created by default, and you can add up to 27 sink point dump files.
- In a cluster system, execute this command on the executing host (host specified for the `-eh` option of the `ajsembdbbuild` command). After executing the command, copy the `ajs2` files from *embedded-database-practical-directory*\CONF to the standby host.

Return values

| | |
|---------------------|--------------|
| 0 | Normal end |
| Values other than 0 | Abnormal end |

Additional information

Each time this command is executed, a file whose name is in the following format is created in the directories specified for the `-d` and `-du` options:

`ajsRRRIIIYYYYMMDDhhmmss{D}`

- RRRRR: Type of expanded resource (value specified for the `-r` option)
- IIII: embedded database setup ID (value specified for the `-id` option)
- YYYY: year
- MM: month
- DD: day
- hh: hours
- mm: minute

- ss: second

Example:

The following shows an example of the command line and the files created when the command is executed at 21:57:30 on March 2, 2010:

```
ajsembdbaddlog -r sys -s 2000 -d L:\sysarea1 -du M:\sysarea2 -id _JF0
L:\sysarea1\ajssys_JF020100302215730
M:\sysarea2\ajssys_JF020100302215730D
```

Actions to be taken if an error occurs

If a command error occurs, take the indicated action in the following table.

| Message | Cause | Action to be taken |
|------------|--|---|
| KAVS0996-E | The specified option contains an error. | Check the specification of the option. |
| KAVS2102-E | The embedded database is being started or stopped. | Use the <code>ajsembdbstatus -s ust</code> command to check whether the embedded database is running and then re-execute the command. |
| KAVS2104-E | The embedded database is not set up. | Set up the embedded database and then re-execute the command. |
| KAVS2116-E | The specified option contains an error. | Check the option output in the message and then re-execute the command. |
| KAVS2117-E | An error occurred during execution of the command. | Check the message output in the maintenance information. |

ajsembddbbackup

Format

```
ajsembddbbackup
  [-mh logical-host-name]
  [-i embedded-database-practical-directory]
  -d data-area-name
  -b backup-file-storage-directory
  [-s]
  [-id embedded-database-setup-ID]
```

Function

Acquires the backup of the embedded database.

This command is available when the embedded database is active.

Execution privileges

In Windows: Administrators privileges

In UNIX: Superuser privileges

Storage directory

In Windows:

JP1/AJS3 - Manager-installation-folder\tools

In UNIX:

/opt/jp1ajs2/tools/

Arguments

-mh *logical-host-name*

Specification of this option is no longer necessary. The logical host name specified by this option is ignored.

-i *embedded-database-practical-directory*

Specify the embedded database directory. Use an absolute path to specify the directory. In Windows, to include space characters in the specified absolute path, enclose the path in double quotation marks ("). You must specify the same directory that you specify in the `-i` option of the `ajsembdbbuild` command. In UNIX, if you omit the `-i` option of the `ajsembdbbuild` command during the setup, you can omit this option.

If you do not specify this argument, `/opt/jp1ajs2/emddb/_JF0` is assumed.

This option is provided for compatibility with versions earlier than 08-00. Normally, use the `-id` option.

If you specify both the `-i` option and the `-id` option, the value specified for the `-i` option takes precedence.

-d data-area-name

Specify the data area name of the embedded database. Use an absolute path to specify the directory. In Windows, to include space characters in the specified absolute path, enclose the path in double quotation marks ("). If you have specified the embedded database directory in the `-d` option of the `ajsembdbbuild` command, specify as follows:

In Windows

```
directory-name-specified-in-the-d-option\ajssys02
```

In UNIX

```
directory-name-specified-in-the-d-option/ajssys02
```

If you want to operate an embedded database created by using the `jajs_setup` or `jajs_migrate` command, use the `ajsembdbidlist` command to check the directory that contains the embedded database. For details on the `ajsembdbidlist` command, see *ajsembdbidlist* in 2. *Commands Used during Setup*.

In Windows

```
[directory-name-displayed-by-the-ajsembdbidlist-command]\dbarea\ajssys02
```

In UNIX

```
/var/opt/jp1ajs2/embdb/_JFn#/dbarea/ajssys02
```

If you operate the embedded database in a logical host environment set up by using the `jajs_setup_cluster` command, specify the value specified for the `-d` option.

In Windows

```
[directory-name-specified-in-the-d-option]\jp1ajs2\embdb\_JFn#\dbarea\ajssys02
```

In UNIX

```
[directory-name-specified-in-the-d-option]/jp1ajs2/embdb/_JFn#/dbarea/ajssys02
```

If you operate the embedded database in a logical host environment set up by using the `jajs_setup_cluster` command, specify the value specified for the `-d` option.

For Windows

```
[directory-name-specified-in-the-D-option]\jp1ajs2\embdb\_JFn#\dbarea\ajssys02
```

For UNIX

```
[directory-name-specified-in-the-D-option]/jp1ajs2/embdb/_JFn#/dbarea/ajssys02
```

#

Specify the value specified for the `-id` option of this command. If you omit the `-id` option, specify `_JF0`.

-b backup-file-storage-directory

Specify the directory that stores the backup file. Use an absolute path to specify the directory. In Windows, to include space characters in the specified absolute path, enclose the path in double quotation marks (").

Create the directory that you are going to specify beforehand. If you specify a directory that does not exist, an error occurs.

The specified directory stores the following files:

- Backup file
- Processing output result file

File names are automatically assigned based on the following rules:

When the `-s` option is specified

- Backup file: `BACK_XXXXYYZZVVWW.bk`
- Output result file: `BACK_XXXXYYZZVVWW.log`

When the `-s` option is not specified

- Backup file: `BACK_MST_XXXXYYZZVVWW.bk`
- Output result file: `BACK_MST_XXXXYYZZVVWW.log`

`XXXX`: Year

`YY`: Month

`ZZ`: Day

`VV`: Hour

`WW`: Minutes

The amount of free space required for the backup file storage directory differs depending on the scale of the embedded database model as shown in the following table.

Table 3–8: Embedded database models and the required free space

| Database model | Required free space |
|----------------|---------------------|
| Large scale | About 6,700 MB |
| Medium scale | About 1,400 MB |
| Small scale | About 200 MB |

If the database area has been expanded by using the `ajsembdbaddarea` command, additional free space equivalent to the area added by the expansion is required. Similarly, if the database auto-increment function is enabled, additional free space equivalent to the area added by the function is required.

For details about the database auto-increment function, see *23.2 Estimating the database area* in the *JPI/Automatic Job Management System 3 Configuration Guide*.

-s

Specify this option when you specify to acquire the backup during operation.

If you acquire a backup of the embedded database, you will need an unload log file when you restore the database from the backup. Therefore, confirm that an unload log file is output. This file is output if the operating status of the automatic log unload functionality is set to `ACTIVE` by using the `ajsembdboplog` command. For details on the `ajsembdboplog` command, see *ajsembdboplog* in *3. Commands Used for Normal Operations*.

-id embedded-database-setup-ID

Specify the setup identifier that identifies the embedded database in the `_JFn` format (*n*: 0-9 or A-Z). The value specified in this argument must be the same as the value specified in the `-id` option of the `ajsembdbbuild` command.

If you want to operate an embedded database created by using the `jajs_setup`, `jajs_setup_cluster`, and `jajs_migrate` commands, use the `ajsembdbidlist` command to check the setup identifier of the embedded database. For details on the `ajsembdbidlist` command, see *ajsembdbidlist* in *2. Commands Used during Setup*.

If you omit this option, the system assumes `_JF0`.

If you specify both the `-id` option and the `-i` option, the `-i` option takes precedence.

Notes

- Do not acquire the backup of an embedded database with a failure. If you do so, and then use that backup file for restoration, a problem might occur.
- Execute this script while the embedded database is active.
- If you execute this script while a job is being executed, the job might end abnormally. In such a case, re-execute the script when job execution load is low.
- When you specify `-s` option and acquire the backup, `ajsembdbstr` command requires the unload log file as the input information.
- If you do not specify `-s` option and acquire the backup, make sure that the database is not updated before you backup the database.
- If you attempt to back up the database when it has been updated, an error might occur.
- To monitor the systemlog files status, use the `ajsembdbstatus` command with the `-l` option specified.

For details about the `ajsembdbstatus` commands, see the sections that cover these commands in *1. Commands*.

For details on the `ajsembdbstatus` command, see *ajsembdbstatus* in *3. Commands Used for Normal Operations*.

- The execution results of the command are output to the log file. The log file is stored in the following directories:

For Windows, if the installation folder is the default installation folder or is in a folder protected by the system:

```
%ALLUSERSPROFILE%\Hitachi\JP1\JP1_DEFAULT\JP1AJS2\log
```

The default of the `%ALLUSERSPROFILE%` value is `system-drive\ProgramData`.

A folder protected by the system is the path to a folder in any of the following:

```
- system-drive\Windows
```

```
- system-drive\Program Files
```

```
- system-drive\Program Files (x86)
```

For Windows, if the installation folder is other than the above:

```
JP1/AJS3-Manager-installation-folder\log
```

For UNIX:

```
/var/opt/jplajs2/log
```

- The file name is `ajsembdbbackup.log`. Since the contents of this file are not overwritten, the file size increases indefinitely. Evacuation or delete the contents of this file as necessary.
If this file does not exist, execute `ajsembdbbackup` command to create a new one.
- If you do not specify the `-s` option, you can restore the embedded database by using only the backup file. Execute the command without `-s` when acquiring the backup in synchronization with JP1/AJS3.
- If you use the backup file that is acquired by specifying the `-s` option to restore the embedded database, you need the unload log file as well. Use caution.
- While you are executing the `ajsembdbbackup` command, a KFPS01278-W or KFPS01279-W warning message may appear.
If `code=1601-0` is included in the KFPS01278-W message or `code=1607-0` is included in the KFPS01279-W message, the backup operation is not affected.
- Do not execute multiple instances of this command concurrently. If you do so, the following problems might occur:
 - A message output error occurs. For example, an incorrect message is output, or a message that should be output is not output.

- This command incorrectly results in an error.
- You cannot execute this command for an embedded database for which the backup enhancement function is enabled. If you do so, an error will occur.

Return values

| | |
|---------------------|--------------|
| 0 | Normal end |
| Values other than 0 | Abnormal end |

Actions to be taken if an error occurs

An error might occur when you execute `ajsembdbbackup` command. If an error occurs, read the following table and take appropriate action.

Table 3–9: Actions to be taken if an error occurs when `ajsembdbbackup` command is executed

| Message | Cause | Action to be taken |
|--|---|---|
| KFPS01280-E AJSEMBDBBACKUP:EmbedDB SYNC END (4) AJSEMBDBBACKUP:[ERROR]pdlogsync -d sys -w - t 180 | The database cannot be backed up since the scheduler database is being updated. | Wait until the job being executed ends, and then re-execute the command. |
| KAVS0996-E | <ul style="list-style-type: none"> • An argument is incorrect. • Some options are not specified. • The path specified in <code>-i</code> option is not for the embedded database practical directory, or the user does not have read privileges. | Review the specified arguments, and then re-execute the command. |
| KFPR26012-E | The path specified in <code>-d</code> option is incorrect, or the user does not have read privileges for the folder indicated by the specified path. | Revise the specified path and privileges, and then re-execute the command. If AJS administrators operate the system, make sure that the AJS administrators have the appropriate privileges. |
| KFPR16003-E | The path specified in <code>-b</code> option is incorrect, or the user does not have write privileges indicated by the specified path. | Revise the specified path and privileges, and then re-execute the command. If AJS administrators operate the system, make sure that the AJS administrators have the appropriate privileges. |
| KFPR26006-E Invalid parameter AAA exists at <code>-m</code> option in command line | The host name specified in <code>-mh</code> option is invalid. | Revise the host name and the specified arguments, and then re-execute the command. |
| KFPS01984-E | The path specified in <code>-i</code> option is not an absolute path. | Revise the specified path, and then re-execute the command. |
| Bad directory specified in <code>-i</code> option | The path specified in the <code>-i</code> option is not the path for the embedded database practical directory, or the user does not have the appropriate privileges. | Specify the correct embedded database directory in <code>-i</code> option. Alternatively, revise the privileges, and then re-execute the command. If the embedded database |

| Message | Cause | Action to be taken |
|---|---|--|
| Bad directory specified in <code>-i</code> option | Alternatively, the system has not been set up correctly. | directory is specified correctly, retry setup of the embedded database. If AJS administrators operate the system, make sure that the AJS administrators have the appropriate privileges. |
| KAVS2104-E | The setup ID specified in <code>-id</code> option is invalid or the embedded database is not set up. | Check whether the setup ID specified in <code>-id</code> option is correct. |
| KAVS8409-E | The <code>ajsembdbbackup</code> command cannot be executed for an embedded database for which the backup enhancement function is enabled. | To back up the embedded database for which the backup enhancement function is enabled, use the <code>jajs_dbbackup</code> command. |

ajsembdbcancel

Format

```
ajsembdbcancel
  -u Server-name or program-name
  -p process-ID
  [-id embedded-database-setup-ID]
```

Description

Cancels the processing of an embedded-database command that is being executed.

Cancellation of the command results in an error. For details about the error that might occur, check the error message or the log for the command.

You can execute this command only when the embedded database is running. You can execute the command regardless of the operating status of JP1/AJS3.

Execution privileges

In Windows: Administrators privileges

In UNIX: Superuser privileges

Storage directory

In Windows:

JP1/AJS3 - Manager-installation-folder\tools\

In UNIX:

/opt/jplajs2/tools/

Arguments

-u *Server-name* or *program-name*

Specifies the name of the server or the name of the program related to execution of the embedded database operation commands.

The name of the program (PROGRAM) or the server name (SVID) related to the embedded database operation commands is output by executing the `ajsembdbstatus` command with the `-s prc` option specified during execution of an embedded database operation command.

The PROGRAM or SVID is output only when a corresponding embedded database operation command is being executed.

The following table lists the PROGRAM and SVID values for each command.

| Command name | SVID# | PROGRAM |
|------------------------------|---------|---------|
| ajsembdbbuild, ajsembdbstart | 0minitx | -- |
| ajsembdbaddarea | -- | pdmod |
| ajsembdbbrorg | 0mrorgx | -- |

| Command name | SVID# | PROGRAM |
|-----------------|---------|---------|
| ajsembdbreclaim | 0mrorgx | -- |
| ajsembdbstatus | 0mdbstx | -- |
| ajsembdbbackup | 0bcpyx | -- |
| ajsembdbrstr | 0brstrx | -- |

Legend:

--: Not applicable

#

The *x* at the end of a program name is a number such as 0, 1, and 2.

The processing of embedded database operation commands other than those listed above cannot be canceled by this command.

-p process-ID

Specify the process ID of the information output by the `ajsembdbstatus` command with the `-s prc` option specified.

-id embedded-database-setup-ID

Specify the setup identifier that identifies the embedded database in the `_JFn` format (*n*: 0-9 or A-Z). The value specified in this argument must be the same as the value specified in the `-id` option of the `ajsembdbbuild` command.

If you want to operate an embedded database created by using the `jajs_setup`, `jajs_setup_cluster`, and `jajs_migrate` commands, use the `ajsembdbidlist` command to check the setup identifier of the embedded database. For details on the `ajsembdbidlist` command, see [ajsembdbidlist](#) in *2. Commands Used during Setup*.

If you omit this option, the system assumes `_JF0`.

Notes

- When you execute this command, the following message appears:

```
4432 16:49:20 unt1 _pd0canc KFPS05082-Q Utility server name=0mrorg0,utilit
y server process id=5456 cancel process ? (y/n)
```

This is a confirmation message asking you whether you want to cancel the processing of the command. Enter `y` if there are no problems.

- This command is implemented by a script. If you specify an excessively long character string or an invalid character string or value for an option, an unexpected error might occur. You must use the number of characters allowed for a character string or a value in the option as specified in the DBMS and JP1/AJS3 specifications.
- If you execute the `ajsembdbstatus` command with the `-s prc` option specified while an embedded database manipulation command is running, the `ajsembdbstatus` command might not output a program name that can be specified for the `-u` option. If that occurs, the processing you attempted to cancel by using the `ajsembdbcancel` command either has not started yet or has already ended.
- Do not execute this command more than once in quick succession. If you do so, the following problems might occur:
 - The message output is invalid. For example, an invalid message is output or a message that should be output is not output.
 - The command results in an error.

Return values

| | |
|---------------------|--------------|
| 0 | Normal end |
| Values other than 0 | Abnormal end |

Actions to be taken if an error occurs

If a command error occurs, take the indicated action in the following table.

| Message | Cause | Action to be taken |
|------------|--|--|
| KAVS0996-E | The specified option contains an error. | Check the specification of the option. |
| KAVS2101-E | The embedded database is inactive. | Start the embedded database and then re-execute the command. |
| KAVS2102-E | The embedded database is being started or stopped. | Confirm that the embedded database is running, and then re-execute the command. You can confirm whether the embedded database is running by executing the <code>ajsembdbstatus</code> command with the <code>-s ust</code> option specified. |
| KAVS2104-E | The embedded database is not set up. | Set up the embedded database and then re-execute the command. |
| KAVS2116-E | The specified option contains an error. | Check the option output in the message and then re-execute the command. |
| KAVS2117-E | An error occurred during execution of the command. | Check the message output in the maintenance information. |

ajsembdboplog

Format

```
ajsembdboplog
  [-s|-r|-t|
  -g system-log-file-group-name -o output-destination-file-name [-f]|-
w]
  [-id embedded-database-setup-ID]
```

Format 1 (for monitoring the status of the automatic log unload functionality)

```
ajsembdboplog
  -s
  [-id embedded-database-setup-ID]
```

Format 2 (for restarting the automatic log unload functionality)

```
ajsembdboplog
  -r
  [-id embedded-database-setup-ID]
```

Format 3 (for stopping the automatic log unload functionality)

```
ajsembdboplog
  -t
  [-id embedded-database-setup-ID]
```

Format 4 (for unloading the system log file)

```
ajsembdboplog
  -g system-log-file-group-name
  -o output-destination-file-name
  [-f]
  [-id embedded-database-setup-ID]
```

Format 5 (for swap the system log file)

```
ajsembdboplog
  -w
  [-id embedded-database-setup-ID]
```

Description

Allows you to perform the following for the system log:

- Control the automatic log unload functionality.
- Unload the specified system log file group to the output destination file and place the system log file group in the unloaded status.
- Swap the system log file (group) that is currently used as the output destination.

When you specify the `-s`, `-r`, `-t`, and `-w` options, you can execute this command only when the embedded database is running. In other cases, you can execute the command regardless of the operating status of the embedded database.

You can execute the command regardless of the operating status of JP1/AJS3.

Execution privileges

In Windows: Administrators privileges

In UNIX: Superuser privileges

Storage directory

In Windows:

`JP1/AJS3 - Manager-installation-folder\tools\`

In UNIX:

`/opt/jplajs2/tools/`

Arguments

-g *system-log-file-group-name*

Specify the group name of the system log file to be unloaded.

To check the system log file group name, execute the `-l` option of the `ajsembdbstatus` command.

-o *output-destination-file-name*

Specify the name of the unload log file that is the output destination.

Use the absolute path to specify the file name. If the specified directory name contains a space character, enclose the path in double quotation marks ("").

Do not specify a disk on a network drive.

The size of the directory that stores the unload log output file differs depending on the scale that is specified by using the `ajsembdbbuild` command. Note that if the system log auto-increment function is used, the space incremented by the function is also required in addition to the space shown in the following table.

| ajsembdbbuild option | Required free space |
|--------------------------------------|---------------------|
| <code>-l</code> (large-scale model) | About 1,200 MB |
| <code>-m</code> (medium-scale model) | About 230 MB |
| <code>-s</code> (small-scale model) | About 30 MB |

In an embedded database environment set up by using the `jajs_setup` or `jajs_setup_cluster` command, the system log auto-increment function is used for the small-scale model (specified by the `-s` option of the `ajsembdbbuild` command).

In an embedded database environment set up by using the `jajs_migrate` command, the system log auto-increment function is used for the scale model specified for the `-s` option of the `jajs_migrate` command. If the `-s` option of the `jajs_migrate` command is omitted, `s` (small-scale model) is assumed.

If the system log file to be unloaded is a new system log file that is added by using the `ajsembdbaddlog` command, you need the free space of the size specified in the `-s` option of the `ajsembdbaddlog` command. Note that if the system log auto-increment function is used, the space incremented by the function is also required in addition to the space shown in the above table.

Each time you unload the system log file, you need the free space described above.

-f

Specify this option when you forcibly unload the system log file. When you specify this option, you can unload the current system log file group or a system log file group that has already been unloaded. However, the status of the system log file group does not change.

You use this option when you need to run the embedded database by using the unload log file and the backup of the embedded database. If an error occurs in the embedded database, the unload log immediately before the error might not be output. In that case, specify the `-f` option to acquire the unload log file. However, if a problem occurred in the system log file of the embedded database, the command might fail and you might not be able to acquire the unload log file.

-s

Specify this option to display the operating status of the automatic log unload functionality.

-r

Specify this option to restart the automatic log unload functionality.

Immediately after the restart, the directory in which the unload log file is created inherits the information of the previous operation.

When you specify this option the command fails if the automatic log unload functionality has already been started.

-t

Specify this option to stop the automatic log unload functionality.

This option cancels the unload processing if there is a system log file being unloaded. The unload log file that is output at this time is incomplete and cannot be used for restoration.

When you specify this option the command fails if the automatic log unload functionality has already been stopped.

-w

Specify this option if you want to swap the system log file (group) that is currently used as the output destination.

-id *embedded-database-setup-ID*

Specify the setup identifier that identifies the embedded database in the `_JFn` format (*n*: 0-9 or A-Z). The value specified in this argument must be the same as the value specified in the `-id` option of the `ajsembdbbuild` command.

If you want to operate an embedded database created by using the `jajs_setup`, `jajs_setup_cluster`, and `jajs_migrate` commands, use the `ajsembdbidlist` command to check the setup identifier of the embedded database. For details on the `ajsembdbidlist` command, see [ajsembdbidlist](#) in *2. Commands Used during Setup*.

If you omit this option, the system assumes `_JF0`.

Notes

- This command is implemented by a script. If you specify an excessively long character string or an invalid character string or value for an option, an unexpected error might occur. You must use the number of characters allowed for a character string or a value in the option as specified in the DBMS and JP1/AJS3 specifications.
- If you specify the `-r` or `-t` option in the `ajsembdboplog` command, you need to enable the automatic log unload functionality for the embedded database before you execute the command. If you specify the `-r` or `-t` option in `ajsembdboplog` in an environment in which the automatic log unload functionality is not enabled, an error occurs.
- When the unload log file and the backup of the embedded database are used to restore the embedded database, stopping the automatic log unload functionality while the embedded database is being restarted results in an incomplete restoration. In this case, JP1/AJS3 restores the embedded database only up to the unload log that is output to the unload log file before the automatic log unload functionality is stopped. If you have stopped the automatic log unload functionality, you need to re-acquire the backup of the embedded database when you restart the automatic log unload functionality.
- When the unload log file and the backup of the embedded database are used to restore the embedded database, stopping the automatic log unload functionality while the embedded database is running the subsequent system log file groups waiting to be unloaded.
If you continue using the embedded database in this state, all the system log file groups eventually wait to be unloaded and the embedded database becomes unavailable.
To prevent this problem from occurring, you might want to stop the automatic log unload functionality. In this case, periodically execute the `ajsembdbstatus` command with the `-l` option specified to check the status of the system log file group, and then execute the `ajsembdboplog` command with the `-g` option specified to unload the system log file group.
- Do not execute this command more than once in quick succession. If you do so, the following problems might occur:
 - The message output is invalid. For example, an invalid message is output or a message that should be output is not output.
 - The command results in an error.

Return values

| | |
|---------------------|--------------|
| 0 | Normal end |
| Values other than 0 | Abnormal end |

Actions to be taken if an error occurs

If a command error occurs, take the indicated action in the following table.

| Message | Cause | Action to be taken |
|------------|--|---|
| KAVS0996-E | The specified option contains an error. | Check the specification of the option. |
| KAVS2101-E | The embedded database is inactive. | Start the embedded database and then re-execute the command. |
| KAVS2102-E | The embedded database is being started or stopped. | Confirm that the embedded database is running, and then re-execute the command. You can confirm that the embedded database is running by executing the <code>ajsembdbstatus</code> command with the <code>-s ust</code> option specified. |
| KAVS2104-E | The embedded database is not set up. | Set up the embedded database and then re-execute the command. |

| Message | Cause | Action to be taken |
|------------|---|---|
| KAVS2105-E | The specified system log file group does not exist. | Check the system log file group name and re-execute the command. |
| KAVS2106-E | Unloading failed. | Execute the <code>ajsembdbstatus</code> command with the <code>-l</code> option specified to check whether the specified system log file group can be unloaded. If the system log file group can be unloaded, wait a while and then re-execute the command. |
| KAVS2116-E | The specified option contains an error. | Check the option output in the message and then re-execute the command. |
| KAVS2117-E | An error occurred during execution of the command. | Check the message output in the maintenance information. |

Output example

The following shows an output example of checking the operating status of the automatic log unload functionality.

```
ajsembdboplog -s -id _JF0

HOSTNAME : 127.0.0.1 (180252)
SERVER_NAME:ajs2
AUTO_LOG_UNLOAD NOW_UNLOAD_LOG_GROUP CREATE_DIR
ACTIVE ***** K:/logback
CURRENT LOG GENERATION INFO.
LOG_GROUP GEN_NO. SERVER_RUN_ID RUN_ID UNLOAD_FILE_NAME
log1 1 43c4ad0d 43c4acf3 ajs2_43c4ad0d0001_log1
```

HOSTNAME

127.0.0.1 is displayed.

The item in parentheses is the hour, minutes, and seconds (format: *HHMMSS*) of the time when the `ajsembdboplog` command is executed.

Cautionary note

If any of the conditions below is met, the host name of the embedded database installation directory is output by using no more than 32 characters. In a cluster configuration, the first host name that is set as the active server is output.

- When JP1/AJS3 - Manager for Windows version 09-50 or earlier is used and the embedded database has been built on a logical host
- When JP1/AJS3 - Manager for UNIX version 09-50 or earlier is used
- When JP1/AJS3 - Manager version 09-50 or earlier is updated to version 10-00 or later, and IPv6 has not been set up

SERVER_NAME

Indicates the identifier of the embedded database with up to four characters. For JP1/AJS3, this identifier is fixed to `ajs2`.

AUTO_LOG_UNLOAD

Indicates the operating status of the automatic log unload functionality.

ACTIVE: The feature is operating.

STOP: The feature is stopped.

-: The automatic log unload functionality is unavailable.

NOW_UNLOAD_LOG_GROUP

Indicates the log file group name of the system log file being unloaded.

**** is output if there is no system log file being unloaded.

CREATE_DIR

Indicates the name of the directory in which the unload log file being used is created.

LOG_GROUP

Indicates the log file group name of the system log file of the current generation.

Gen No.

Indicates the generation number of the log with a hexadecimal number of up to eight.

SERVER_RUN_ID

Indicates the information used by the system.

RUN_ID

Indicates the information used by the system.

UNLOAD_FILE_NAME

Indicates the name of the file that is created when the log of the current generation is automatically unloaded.

ajsembdbreclaim

Format

```
ajsembdbreclaim
  -m {manager|
      scheduler [-F scheduler-service-name] |
      agent}
  [-mh logical-host-name]
  [-t {d|f}]
  [-r {1|2}]
```

Format 1 (for maintaining the scheduler service under the manager and agent management)

```
ajsembdbreclaim
  -m manager
  [-mh logical-host-name]
  -t f
  -r 2
```

Format 2 (for maintaining the index area for the scheduler service under the manager and agent management)

```
ajsembdbreclaim
  -m manager
  [-mh logical-host-name]
  -t d
  -r 2
```

Format 3 (for maintaining the pages for the scheduler service under the manager and agent management)

```
ajsembdbreclaim
  -m manager
  [-mh logical-host-name]
  -t f
  -r 1
```

Format 4 (for maintaining only the pages in the index area for the scheduler service under the manager and agent management)

```
ajsembdbreclaim
  -m manager
  [-mh logical-host-name]
  -t d
  -r 1
```

Format 5 (for maintaining the specified scheduler service)

```
ajsembdbreclaim
  -m scheduler
  [-F scheduler-service-name]
  [-mh logical-host-name]
```

```
-t f
-r 2
```

Format 6 (for maintaining the index area for the specified scheduler service)

```
ajsembdbreclaim
-m scheduler
[-F scheduler-service-name]
[-mh logical-host-name]
-t d
-r 2
```

Format 7 (for maintaining the pages for the specified scheduler service)

```
ajsembdbreclaim
-m scheduler
[-F scheduler-service-name]
[-mh logical-host-name]
-t f
-r 1
```

Format 8 (for maintaining only the pages in the index area for the specified scheduler service)

```
ajsembdbreclaim
-m scheduler
[-F scheduler-service-name]
[-mh logical-host-name]
-t d
-r 1
```

Format 9 (for maintaining agent management)

```
ajsembdbreclaim
-m agent
[-mh logical-host-name]
-t f
-r 2
```

Format 10 (for maintaining the index area used for agent management)

```
ajsembdbreclaim
-m agent
[-mh logical-host-name]
-t d
-r 2
```

Format 11 (for maintaining the pages used for agent management)

```
ajsembdbreclaim
-m agent
[-mh logical-host-name]
-t f
-r 1
```

Format 12 (for maintaining only the pages in the index area used for agent management)

```
ajsembdbreclaim
  -m agent
  [-mh logical-host-name]
  -t d
  -r 1
```

Description

Maintains the areas in the embedded database used by JP1/AJS3.

You can execute this command only when the embedded database is running. You can execute the command regardless of the operating status of JP1/AJS3.

Execution privileges

In Windows: Administrators privileges

In UNIX: Superuser privileges

Storage directory

In Windows:

JP1/AJS3 - Manager-installation-folder\tools\

In UNIX:

/opt/jp1ajs2/tools/

Arguments

-m {*manager* | *scheduler* | *agent*}

Specify the range of maintenance.

- *manager*
Specify this option to maintain all scheduler services and the agent management in JP1/AJS3 - Manager.
You can specify this option together with the **-mh** option.
- *scheduler*
Specify this option to maintain the areas for the specified scheduler service.
You can specify this option together with the **-mh** and **-F** options.
- *agent*
Specify this option to maintain agent management.
You can specify this option together with the **-mh** options.

-F *scheduler-service-name*

Specify the name of the scheduler service for which you want to maintain the areas.

If you omit this option, the system assumes the default scheduler service name.

-mh *logical-host-name*

Specify the target JP1 logical host name.

You can specify a character string of 1 to 32 bytes.

If you omit this option and environment variable `JP1_HOSTNAME` has been set, the system assumes the value set for `JP1_HOSTNAME`. If environment variable `JP1_HOSTNAME` has not been set, the system assumes the physical host name.

-t d | f

Specify the maintenance mode.

- `d`
Specify this option to maintain the area where indexes are stored.
- `f`
Specify this option to maintain the areas where indexes and data are stored.

If you omit this option, the system assumes `f`.

Depending on the type of operation, the data storage area might become full before the index storage area does. Execute the `-db -d` option of the `ajsembdbstatus` command and check the obtained output result. If only a few pages in the data storage area can be released, but many pages in the index storage area can be released, specify the `-t d` option when you execute the command so that you can maintain the areas efficiently.

-r 1 | 2

Specify the level of maintenance.

- `1`
Specify this option to release only pages.
- `2`
Specify this option to release pages and segments.

If you omit this option, the system assumes `2`.

Execute the `-db -d` option of the `ajsembdbstatus` command and check the obtained output result. If many pages can be released, but only a few segments are being used, specify the `-r 1` option when you execute the command so that you can maintain the areas efficiently.

Notes

- This command is implemented by a script. If you specify an excessively long character string or an invalid character string or value for an option, an unexpected error might occur. You must use the number of characters allowed for a character string or a value in the option as specified in the DBMS and JP1/AJS3 specifications.
- If either of the following conditions is met, a timeout error might occur for the `ajsembdbreclaim` command:
 - When the job execution load of a job or jobnet is high
 - When a unit is operated by using a command or in JP1/AJS3 - View
 - When the usage states of scheduler services or the delay states of jobnets with start conditions are aggregated from the Web GUI (Management Portal)

If a timeout error occurs, re-execute the `ajsembdbreclaim` command when none of the preceding cases applies.

- If a failure such as a communication or disk failure occurs during execution of this command, the command might not respond. If the non-responding command cannot be killed manually (for example, when a job is automatically executed from another job), you can specify the embedded database system common definition

`pd_utl_exec_time` to kill the command. For details about `pd_utl_exec_time`, see the system common definition in the *23.1.1 Examining the embedded-database operating environment and operating method* in the *JPI/Automatic Job Management System 3 Configuration Guide*.

- If multiple `ajsembdbreclaim` commands are executed concurrently for a single embedded database, one of the commands might abnormally terminate and the message `KFPA11770-I` will be displayed. In this case, no action is needed if any one of the commands is executed successfully. Note that if multiple `ajsembdbreclaim` commands are executed concurrently for a single embedded database, a conflict might occur during log output processing, and the following message might be output between lines in the output result:

```
The process cannot access the file. The file is being used by
another process.
```

You can ignore this message because there are no problems with the output results.
- If you execute the `ajsembdbreclaim` command in a state in which large quantities of unavailable areas occur in the database because maintenance has not been performed for a long time, a lot of data is sent to the system log. An embedded database terminates abnormally if the system log capacity is insufficient. Therefore, estimate the required system log capacity and, if the log capacity is insufficient, add a system log and then execute the `ajsembdbreclaim` command. For details about how to check the unavailable area and the system log capacity required for execution of the `ajsembdbreclaim` command, see *9.1.1 Analyzing the database area* in the *JPI/Automatic Job Management System 3 Administration Guide*.
- When `-m manager` is specified for the `ajsembdbreclaim` command and the command is executed, even if the `KAVS2117-E` message is output, maintenance processing other than the maintenance processing of the scheduler service that detects an abnormality will continue. For the maintenance processing of the scheduler service that detected the abnormality, remove the cause of the problem, and then execute the `ajsembdbreclaim` command again if necessary.
- Do not execute the `ajsembdbreclaim` command at the same time with maintenance performed by the automatic maintenance function.

Return values

| | |
|---------------------|--------------|
| 0 | Normal end |
| Values other than 0 | Abnormal end |

Actions to be taken if an error occurs

If a command error occurs, take the indicated action in the following table.

| Message | Cause | Action to be taken |
|-------------------------|--|--|
| <code>KAVS0996-E</code> | The specified option contains an error. | Check the specification of the option. |
| <code>KAVS2101-E</code> | The embedded database is inactive. | Start the embedded database and then re-execute the command. |
| <code>KAVS2102-E</code> | The embedded database is being started or stopped. | Use the <code>-s ust</code> option of the <code>ajsembdbstatus</code> command to check whether the embedded database is running and then re-execute the command. |
| <code>KAVS2104-E</code> | The embedded database is not set up. | Set up the embedded database and then re-execute the command. |
| <code>KAVS2116-E</code> | The specified option contains an error. | Check the option output in the message and then re-execute the command. |

| Message | Cause | Action to be taken |
|------------|--|---|
| KAVS2117-E | An error occurred during execution of the command. | <p>Check the message output in the maintenance information.</p> <p>If the <code>ajsembdbreclaim</code> command times out because a high-load job or jobnet is running, re-execute the job when the system load is low.</p> <p>If the <code>ajsembdbreclaim</code> command times out because of unit operations by commands or in JP1/AJS3 - View, re-execute the command after those unit operations have finished.</p> |
| KAVS2123-E | The version of the embedded database is invalid. | Update the embedded database to a version supported by JP1/AJS3. |

ajsembdbbrorg

Format

```
ajsembdbbrorg
  -k {unld|reld}
  [-F scheduler-service-name]
  [-mh logical-host-name]
  [-agent]
  -d name-of-directory-where-unload-file-stored
```

Format 1 (for storing the data in the embedded database in the unload data file)

```
ajsembdbbrorg
  -k unld
  [-F scheduler-service-name]
  [-mh logical-host-name]
  [-agent]
  -d name-of-directory-where-unload-file-stored
```

Format 2 (for restoring the data in the embedded database by using the unload data file)

```
ajsembdbbrorg
  -k reld
  [-F scheduler-service-name]
  [-mh logical-host-name]
  [-agent]
  -d name-of-directory-where-unload-file-stored
```

Description

Obtains and restores the data in the embedded database.

You can execute this command only while the embedded database and all the scheduler services for which the applicable embedded database was created as the scheduler database are not running.

Execution privileges

In Windows: Administrators privileges

In UNIX: Superuser privileges

Storage directory

In Windows:

JP1/AJS3 - Manager-installation-folder\tools

In UNIX:

/opt/jp1ajs2/tools/

Arguments

-k unld | reld

Specify the type of processing.

- `unld`
Specify this option to store the data in the database of the specified scheduler service in the unload data file.
- `reld`
Specify this option to restore the data in the database of the specified scheduler service from the unload data file.

-F *scheduler-service-name*

Specify the name of the target scheduler service.

If you omit this option, the system assumes the default scheduler service name.

Specification of this option is overridden by the `-agent` option specification.

-mh *logical-host-name*

Specify the name of the target JP1 logical host.

You can specify a character string of 1 to 32 bytes.

If you omit this option and environment variable `JP1_HOSTNAME` has been set, the system assumes the value set for `JP1_HOSTNAME`. If environment variable `JP1_HOSTNAME` has not been set, the system assumes the physical host name.

-agent

Specify this option if you want to execute the command for the database for the agent management.

Specification of this option overrides the `-F` option specification.

-d *name-of-directory-where-unload-file-stored*

Specify the name of the directory that stores the unload file.

Use the absolute path to specify the directory name. If the specified directory name contains a space character, enclose the path in double quotation marks ("").

Do not specify a disk on a network drive.

Prepare the directory you are going to specify beforehand. If you specify a non-existent directory, an error occurs.

When you specify `unld` for the `-k` option, the unload file is created in the directory specified here.

If the file already exists, a confirmation message asking you whether you want to delete the file appears.

Message to be output: `OK to Overwrite the unload file?(y/n) :`

To delete the file, enter `y`.

Notes

- This command is implemented by a script. If you specify an excessively long character string or an invalid character string or value for an option, an unexpected error might occur. You must use the number of characters allowed for a character string or a value in the option as specified in the DBMS and JP1/AJS3 specifications.
- Before you execute this command, stop all the scheduler services for which the applicable embedded database is created as the scheduler database. In addition, stop all the services that are accessing the embedded database,

including the JP1/AJS3 service. If you execute this command without stopping services, you might need to wait for a long time.

- When you specify `unld` for the `-k` option, the directory you specify in the `-d` option must have the following free space:

| ajsembdbbuild option | Required free space |
|--------------------------------------|---------------------|
| <code>-l</code> (large-scale model) | About 6,700 MB |
| <code>-m</code> (medium-scale model) | About 1,400 MB |
| <code>-s</code> (small-scale model) | About 200 MB |

Furthermore, if the backup enhancement function is enabled, the following free disk space is required for the directory specified for the `-d` option.

| ajsembdbbuild option | Required free space |
|--------------------------------------|---------------------|
| <code>-l</code> (large-scale model) | About 7,200 MB |
| <code>-m</code> (medium-scale model) | About 1,900 MB |
| <code>-s</code> (small-scale model) | About 700 MB |

You can check the setting of the backup enhancement function by using the `ajsembdbstatus` command. For details about the `ajsembdbstatus` command, see [ajsembdbstatus](#) in *3. Commands Used for Normal Operations*. Note that if the embedded database area is expanded by the `ajsembdbaddarea` command or the system log auto-increment function, the space incremented by the command or function is also required in addition to the space shown in the above table.

Each time you execute this command, the above free space is required.

- Before you execute the command with the `-k reld` option (restoration) specified, make sure that maintenance of the embedded database area has been completed by using the `ajsembdbreclaim` command.
- If a failure such as a communication or disk failure occurs during execution of this command, the command might not respond. If the non-responding command cannot be killed manually, you can specify the embedded database system common definition `pd_utl_exec_time` to kill the command. For details about `pd_utl_exec_time`, see the system common definition in the *23.1.1 Examining the embedded-database operating environment and operating method* in the *JP1/Automatic Job Management System 3 Configuration Guide*.
- Do not execute multiple `ajsembdborg` commands with the same scheduler service name set in the `-F` option for each command.
- Do not concurrently execute for a single embedded database multiple `ajsembdborg` commands in which the `-agent` option is specified.
- The setting of the backup enhancement function must be the same between the environment where data is to be restored by using the `-k reld` option and the environment where data was stored by using the `-k unld` option. For example, data that was stored by using the `-k unld` option in an environment where the backup enhancement function is enabled cannot be restored by using the `-k reld` option in an environment where the function is disabled.

Return values

| | |
|---------------------|--------------|
| 0 | Normal end |
| Values other than 0 | Abnormal end |

Actions to be taken if an error occurs

If a command error occurs, take the indicated action in the following table.

| Message | Cause | Action to be taken |
|-------------|---|--|
| KAVS0996-E | The specified option contains an error. | Check the specification of the option. |
| KAVS2101-E | The embedded database is inactive. | Start the embedded database and then re-execute the command. |
| KAVS2102-E | The embedded database is being started or stopped. | Use the <code>-s ust</code> option of the <code>ajsembdbstatus</code> command to check whether the embedded database is running and then re-execute the command. |
| KAVS2104-E | The embedded database is not set up. | Set up the embedded database and then re-execute the command. |
| KAVS2106-E | Unloading failed. | Wait a while and then re-execute the command. |
| KAVS2107-E | Reloading failed. | Specify the correct unload data file and then re-execute the command. |
| KAVS2113-E | The specified directory does not exist. | Check the argument specified in the <code>-d</code> option and then re-execute the command. |
| KAVS2116-E | The specified option contains an error. | Check the option output in the message and then re-execute the command. |
| KAVS2117-E | An error occurred during execution of the command. | Check the message output in the maintenance information. |
| KFPL15047-E | There is no permission for the path specified in the <code>-d</code> option or for the unload log file in the path. | Check the permissions for the specified path or for the unload log file, and then re-execute the command. If AJS administrators operate the system, make sure that the AJS administrators have the appropriate privileges. |

ajsembdbrstr

Format

```
ajsembdbrstr
  [-mh logical-host-name]
  [-M]
  [-i embedded-database-practical-directory]
  -d data-area-name
  -bf backup-file
  [-l unload-log-file-1,unload-log-file-2,...]
  -ld unload-log-storage-directory
  -e output-result-file-storage-directory
  [-id embedded-database-setup-ID]
```

Description

Backs up the embedded database, or restores the embedded database using the backup and the unload log file.

Execution privileges

In Windows: Administrators privileges

In UNIX: Superuser privileges

Storage directory

In Windows:

JPI/AJS3 - Manager-installation-folder\tools

In UNIX:

/opt/jp1ajs2/tools/

Arguments

-mh *logical-host-name*

Specification of this option is no longer necessary. The logical host name specified by this option is ignored.

-M

Specify this argument to restore the system area.

The system area stores the internal information about the embedded database system.

To restore the system area of the embedded database, you must start the embedded database in a special mode that allows the restoration of the system area.

In this mode, you cannot restore the data area. Once you complete restoration of the system area, you must execute the `ajsembdbstop` command to stop the embedded database, and then execute the `ajsembdbstart` command, without options, to restart the embedded database.

When you want to restore the system area and the data area, specify the same options other than `-M`, the same backup file, and the same unload file.

If you specify different options, or a different backup file or unload file, data might be damaged. Use caution.

In the following case, restore the data area after you restore the system area by specifying `-M`:

- The embedded database server stops due to a failure, and does not start even if you attempt to restart it.
 1. Resolve the problem in the embedded database.
 2. Execute the `ajsembdbstart` command with the `-r` option to start the embedded database in the status where the system area can be restored.
 3. Execute the `ajsembdbstr` command with the `-M` option to restore the system area of the embedded database.
 4. If step 3 ends normally, execute the `ajsembdbstop` command to stop the embedded database that has started in the status where the system area can be restored.
 5. Execute the `ajsembdbstart` command for the embedded database, to start the embedded database in the normal status.
 6. Execute `ajsembdbstr` to restore the data area in the embedded database.

For details about the `ajsembdbstart` and `ajsembdbstop` commands, see *ajsembdbstart* in [3. Commands Used for Normal Operations](#) and *ajsembdbstop* in [3. Commands Used for Normal Operations](#).

-i embedded-database-practical-directory

Specify the embedded database directory. Use an absolute path to specify the directory. In Windows, to include space characters in the specified absolute path, enclose the path in double quotation marks ("). You must specify the same directory that you specify in the `-i` option of the `ajsembdbbuild` command. In UNIX. If you omit the `-i` option of the `ajsembdbbuild` command during the setup, you can omit this option.

If you omit this argument, `/opt/jp1ajs2/emdbd/_JF0/` is assumed.

If you specify both the `-i` option and the `-id` option, the value specified for the `-i` option takes precedence.

-d data-area-name

Specify the data area name of the embedded database. Use an absolute path to specify the directory. In Windows, to include space characters in the specified absolute path, enclose the path in double quotation marks ("). If you have specified the embedded database directory in the `-d` option of the `ajsembdbbuild` command, specify as follows:

For Windows:

directory-name-specified-in-the-d-option\ajssys02

For UNIX:

directory-name-specified-in-the-d-option/ajssys02

If you want to operate an embedded database created by using the `jajs_setup` or `jajs_migrate` command, use the `ajsembdbidlist` command to check the directory that contains the embedded database. For details on the `ajsembdbidlist` command, see *ajsembdbidlist* in [2. Commands Used during Setup](#).

For Windows:

[*directory-name-displayed-by-the-ajsembdbidlist-command*]\dbarea\ajssys02

For UNIX:

/var/opt/jp1ajs2/emdbd/_JFn#/dbarea/ajssys02

If you operate the embedded database in a logical host environment set up by using the `jaajs_setup_cluster` command, specify the value specified for the `-d` option.

For Windows:

```
[directory-name-specified-in-the-d-option] \jp1ajs2\embdb\_JFn#\dbarea\ajssys02
```

For UNIX:

```
[directory-name-specified-in-the-d-option] /jp1ajs2/embdb/_JFn#/dbarea/ajssys02
```

If you operate the embedded database in a logical host environment set up by using the `jaajs_setup` command, specify the value specified for the `-D` option.

For Windows:

```
[directory-name-specified-in-the-d-option] \jp1ajs2\embdb\_JFn#\dbarea\ajssys02
```

For UNIX:

```
[directory-name-specified-in-the-d-option] /jp1ajs2/embdb/_JFn#/dbarea/ajssys02
```

#

Specify the value specified for the `-id` option of this command. If you omit the `-id` option, specify `_JF0`.

-bf backup-file

Specify the backup file that is acquired using `ajsembdbbackup` command.

Use an absolute path to specify the directory. In Windows, to include space characters in the specified absolute path, enclose the path in double quotation marks (").

-l unload-log-file-1, unload-log-file-2, . . .

Specify this argument to use the acquired unload log file to restore the embedded database. You specify this argument when you specify the `-bl` option of the `ajsembdbbuild` command to create an embedded database.

Use an absolute path to specify an unload log file. In Windows, to include space characters in the specified absolute path, enclose the path in double quotation marks ("). Specify the unload log files in the sequence they are acquired. When you specify two or more unload log files, enclose the path after `-l` in double quotation marks (").

If you do not specify `-s` option when you acquire the backup, you can omit the input of the unload log file. In such a case, the database is restored up to the point when the backup is acquired.

-ld unload-log-storage-directory

In the same way as the `-l` option, you can specify this option if you want to use unload log files for restoration. Specify the absolute path name of the directory that contains the unload log files.

In Windows, if you specify an absolute path that contains spaces, enclose the entire path in double quotation marks (").

-e output-result-file-storage-directory

Specify the directory that stores the output result of the restoration. In Windows, use an absolute path to specify the directory. To include space characters in the specified absolute path, enclose the path in double quotation marks ("). You must create the directory you are going to specify beforehand. If the specified directory does not exist, an error occurs.

The following file is stored in the specified directory:

- Processing output result file

The file name is automatically assigned based on the following rules:

- Output result file: `RSTR_XXXXYYZZVWWW.log`
`XXXX`: Year
`YY`: Month
`ZZ`: Day
`VV`: Hour
`WW`: Minutes

-id *embedded-database-setup-ID*

Specify the setup identifier that identifies the embedded database in the `_JFn` format (*n*: 0-9 or A-Z). The value specified in this argument must be the same as the value specified in the `-id` option of the `ajsembdbbuild` command.

If you want to operate an embedded database created by using the `jajs_setup`, `jajs_setup_cluster`, and `jajs_migrate` commands, use the `ajsembdbidlist` command to check the setup identifier of the embedded database. For details on the `ajsembdbidlist` command, see [ajsembdbidlist](#) in *2. Commands Used during Setup*.

If you omit this option, the system assumes `_JF0`.

If you specify both the `-id` option and the `-i` option, the `-i` option takes precedence.

Notes

- If the unload log is used in an embedded-database environment that has been created by using advanced setup, before executing the `ajsembdbbrstr` command, execute the `ajsembdboplog` command with the `-w` option specified. Doing this unloads the current system log file. If the `ajsembdbbrstr` command fails, you do not need to execute the `ajsembdboplog` command again before re-executing the `ajsembdbbrstr` command.
- Execute the command when the scheduler service is inactive.
- If an error occurs during restoration, the database recovery might be incomplete. If an error occurs, do not start the scheduler service immediately.
- When you execute `ajsembdbbackup` command with the `-s` option to acquire the backup, the restoration using the `ajsembdbbrstr` command script requires the unload log file as input information.
- If you execute `ajsembdbbackup` command without the `-s` option to acquire the backup, the `ajsembdbbrstr` command script can restore the embedded database using only the backup file, and does not use the unload log file. In such a case, the database can be restored up to the point when the backup is acquired.
- When restoration ends normally, acquire the backup.
- The execution results of the command are output to the log file. The log file is stored in the following directories:

For Windows, if the installation folder is the default installation folder or is in a folder protected by the system:

`%ALLUSERSPROFILE%\Hitachi\JP1\JP1_DEFAULT\JP1AJS2\log`

The default of the `%ALLUSERSPROFILE%` value is `system-drive\ProgramData`.

A *folder protected by the system* is the path to a folder in any of the following:

- `system-drive\Windows`

- `system-drive\Program Files`

- `system-drive\Program Files (x86)`

For Windows, if the installation folder is other than the above:

`JP1/AJS3-Manager-installation-folder\log`

For UNIX:

```
/var/opt/jplajs2/log
```

The file name is `ajsembdbrstr.log`. Since the contents of this file are not overwritten, the file size increases indefinitely. Evacuation or delete the contents of this file as necessary.

When this file does not exist, execute `ajsembdbrstr` to create a new one.

- If an error occurs when `ajsembdbrstr` command is executed, the database area of the embedded database is blocked. If you re-execute `ajsembdbrstr` command in this status, an error occurs. In such a case, execute the following command for the embedded database to release the blocked status of the database area:

```
pdrels -r ALL -o
```

Note that before you execute the `pdrels` command, you need to set environment variables from the command prompt. For details about the environment variables you need to set, see the table that describes the applicable environment variables in *9.2.3(2) Using a script to reorganize the database* in the *JP1/Automatic Job Management System 3 Administration Guide*.

- To delete the environment of the embedded database, re-create the environment of the embedded database, and then restore the data, complete `ajsembdbsetup` command, and then execute `ajsembdbrstr` command.

If the embedded database area has been expanded by using the `ajsembdbaddarea` command, the same expansion is also necessary before you execute the `ajsembdbrstr` command. However, if the unload log is used in an embedded database environment created by using advanced setup, make sure that you execute the `ajsembdboplog` command with the `-w` option specified before performing the expansion.

The expansion procedure is as follows.

For Windows:

1. Back up the following folder:

```
embedded-database-practical-folder#\CONF\embrm
```

2. Execute the `ajsembdbunset` command.
3. Execute the `ajsembdbbuild` command.
4. Execute the `ajsembdbsetup` command.
5. In the folder you backed up in step 1, rename the `addarea` file to `addarea.bat`, and then execute the file.
6. Execute the `ajsembdbrstr` command.
7. Change the name of the file you renamed in step 5 back to `addarea`.
8. Restore the folder you backed up in step 1 to the following folder:

```
embedded-database-practical-folder#\CONF
```
9. Delete the folder you backed up in step 1.

For UNIX:

1. Back up the following directory:

```
embedded-database-practical-directory#/conf/embrm
```

2. Execute the `ajsembdbunset` command.
3. Execute the `ajsembdbbuild` command.
4. Execute the `ajsembdbsetup` command.
5. In the folder you backed up in step 1, add execute permission to the access permissions of the `addarea` file, and then execute the file.

6. Execute the `ajsembdbrstr` command.
7. Restore the directory you backed up in step 1 to the following directory:
`embedded-database-practical-directory#/conf`
8. Delete the directory you backed up in step 1.

You can check the embedded database practical folder or directory by using the `ajsembdbidlist` command. For details on the `ajsembdbidlist` command, see [ajsembdbidlist](#) in *2. Commands Used during Setup*.

- Specifying the `-l` option causes an error in `ajsembdbrstr` command if update information is not stored in the actually specified unload log file.
- Do not execute multiple instances of this command concurrently. If you do so, the command instances might incorrectly result in an error.
- You cannot execute this command for an embedded database for which the backup enhancement function is enabled. If you do so, an error will occur

Return values

| | |
|---------------------|--------------|
| 0 | Normal end |
| Values other than 0 | Abnormal end |

Actions to be taken if an error occurs

An error might occur when `ajsembdbrstr` command is executed. If an error occurs, read the following table and take appropriate action.

Table 3–10: Actions to be taken if an error occurs when `ajsembdbrstr` command is executed

| Message | Cause | Action to be taken |
|---|--|---|
| KFPR26227-E | The unload log file is not specified. | Execute the following embedded database commands such as <code>pdstop</code> or <code>pdstart</code> , specify the unload log file in <code>-l</code> option, and then re-execute the <code>ajsembdbrstr</code> command. <pre>pdrels -r ALL -o</pre> |
| KAVS0996-E | <ul style="list-style-type: none"> • An argument is incorrect. • Some options are not specified. • Mutually exclusive options are specified simultaneously. • The path specified in <code>-i</code> does not indicate the embedded database practical directory, or the user does not have read privileges. | Review the specified arguments and re-execute the command. |
| KFPR00765-I <code>Pdrstr</code> terminated, return code=8 or KFPR00765-I <code>Pdrstr</code> terminated, return code=12 | <ul style="list-style-type: none"> • The host name specified in <code>-mh</code> option is incorrect. • The path specified in <code>-d</code>, <code>-bf</code>, <code>-e</code>, or <code>-l</code> option is incorrect. • The path specified in <code>-d</code>, <code>-bf</code>, <code>-e</code>, or <code>-l</code> option is not a absolute path. | Review the specified path, execute the following embedded database command, and re-execute the command. <pre>pdrels -r ALL -o</pre> |
| KFPR26203-E | There is no permission for the path specified in the <code>-e</code> option or <code>-ld</code> option. | Check the permissions for the specified path, and then re-execute the command. If AJS administrators operate the system, make |

| Message | Cause | Action to be taken |
|---|--|---|
| KFPR26203-E | There is no permission for the path specified in the <code>-e</code> option or <code>-ld</code> option. | sure that the AJS administrators have the appropriate privileges. |
| KFPS01984-E | The path specified in <code>-i</code> option is not a absolute path. | Revise the specified path, execute the <code>pdstart</code> command, and then re-execute the <code>ajsembdbrstr</code> command. |
| KFPH27006-E | There is no permission for the path specified in the <code>-d</code> option. | Check the permissions for the specified path, and then re-execute the command. If AJS administrators operate the system, make sure that the AJS administrators have the appropriate privileges. |
| KFPH27008-E | Referencing is not possible, because the database area is blocked. | Execute the following embedded database command, and then re-execute the <code>ajsembdbrstr</code> command. <pre>pdrels -r ALL -o</pre> |
| Bad directory specified in <code>-i</code> option | The path specified in the <code>-i</code> option is not the path for the embedded database practical directory, or the user does not have the appropriate privileges. Alternatively, the system has not been set up correctly. | Specify the correct embedded database directory in <code>-i</code> option. Alternatively, check the permissions and then re-execute the command. If the embedded database directory is specified correctly, retry set up of the embedded database. If AJS administrators operate the system, make sure that the AJS administrators have the appropriate privileges. |
| KAVS2104-E | The setup ID specified in <code>-id</code> option is invalid or the embedded database is not set up. | Check whether the setup ID specified in <code>-id</code> option is correct. Alternatively, use <code>ajsstatus</code> to check whether the embedded database is set as the database for the scheduler service. |
| KAVS8409-E | The command cannot be executed because the backup enhancement function is enabled. | To restore the embedded database for which the backup enhancement function is enabled, use the <code>jajs_dbrestore</code> command. |

ajsembdbstart

Format

```
ajsembdbstart
  [-R|Rf]
  [-r]
  [-id embedded-database-setup-ID]
```

Format 1 (for starting the embedded database)

```
ajsembdbstart
  [-id embedded-database-setup-ID]
```

Format 2 (for starting the embedded database to restore the area storing the internal information of the embedded database system)

```
ajsembdbstart
  -r
  [-id embedded-database-setup-ID]
```

Format 3 (for starting the embedded database after canceling suppression of starting the embedded database (in UNIX only))

```
ajsembdbstart
  -R [-r] [-id embedded-database-setup-ID]
```

Format 4 (for canceling suppression of starting the embedded database (in UNIX only))

```
ajsembdbstart
  -Rf [-id embedded-database-setup-ID]
```

Description

Starts the embedded database.

You can execute this command only while the embedded database and all the scheduler services for which the applicable embedded database was created as the scheduler database are not running.

Execution privileges

In Windows: Administrators privileges

In UNIX: Superuser privileges

Storage directory

In Windows:

JP1/AJS3 - Manager-installation-folder\tools

In UNIX:

/opt/jp1ajs2/tools/

Arguments

-r

Specify this option when you use the `ajsembdbrstr` command to restore the system area in the embedded database.

-id *embedded-database-setup-ID*

Specify the setup identifier that identifies the embedded database in the `_JFn` format (*n*: 0-9 or A-Z). The value specified in this argument must be the same as the value specified in the `-id` option of the `ajsembdbbuild` command.

If you want to operate an embedded database created by using the `jajs_setup`, `jajs_setup_cluster`, and `jajs_migrate` commands, use the `ajsembdbidlist` command to check the setup identifier of the embedded database. For details on the `ajsembdbidlist` command, see [ajsembdbidlist](#) in *2. Commands Used during Setup*.

If you omit this option, the system assumes `_JF0`.

-R

This option, which can be used in UNIX only, cancels suppression of starting the embedded database, and then starts the embedded database.

Before you specify this option, make sure that the embedded database is inactive and the error indicated by the reason code in the KFPS00715-E message has been corrected.

-Rf

This is a UNIX-specific option that is used to cancel suppression of starting the embedded database.

Specifying this option does not start the embedded database. However, if the embedded database uses a method to cancel suppression of starting the embedded database that was available earlier than version 10-00, and the embedded database is in a non-cluster environment, the embedded database is automatically started after the suppression of starting is canceled.

Specification of this option overrides the `-r` option specification.

Notes

- This command is implemented by a script. If you specify an excessively long character string or an invalid character string or value for an option, an unexpected error might occur. You must use the number of characters allowed for a character string or a value in the option as specified in the DBMS and JP1/AJS3 specifications.
- You cannot execute this command together with any of the following commands on the same logical host:
 - `ajspofalter` command
 - `ajsembdbstart` command
 - `ajsembdbstop` command
 - `ajsstart` command
 - `ajsstop` command
 - `jajs_hstd` command
 - `jajs_hstd_stop` command
 - `jajs_spmd` command
 - `jajs_spmd_status` command
 - `jajs_spmd_stop` command
 - `jajs_start` command (UNIX only)

`jajs_start.cluster` command (UNIX only)

`jajs_stop` command (UNIX only)

`jajs_stop.cluster` command (UNIX only)

- When JP1/AJS3 is running, the `jajs_dbmd` process stopped by the `ajsembdbstop` command also starts. Note, however, that if the type of the embedded database is one used for JP1/AJS3 - Manager before version 10-00, the `jajs_dbmd` process does not start.
- Do not execute this command more than once in quick succession. If you do so, the following problems might occur:
 - The message output is invalid. For example, an invalid message is output or a message that should be output is not output.
 - The command results in an error.
- In Windows, make sure that the embedded database service has started. If this command is executed when the service has not started, an error occurs and the messages KAVS2117-E and KFPS01801-E appear.

Return values

| | |
|--------------|---|
| 0 | Normal end |
| 1 | The embedded database is being started or stopped |
| 2 | The embedded database is active |
| Other values | Abnormal end |

Actions to be taken if an error occurs

If a command error occurs, take the indicated action in the following table.

| Message | Cause | Action to be taken |
|------------|--|--|
| KAVS0787-E | The system administration daemon is processing. | Use the <code>jajs_spmd_status</code> command to check the service status, and then re-execute the command. |
| KAVS0996-E | The specified option contains an error. | Check the specification of the option. |
| KAVS2102-E | The embedded database is being started or stopped. | Use the <code>-s ust</code> option of the <code>ajsembdbstatus</code> command to check whether the embedded database is running and then re-execute the command. |
| KAVS2103-E | The embedded database is running. | The embedded database is already started and no action is required. |
| KAVS2104-E | The embedded database is not set up. | Set up the embedded database and then re-execute the command. |
| KAVS2116-E | The specified option contains an error. | Check the option output in the message and then re-execute the command. |
| KAVS2117-E | An error occurred during execution of the command. | Check the message output in the maintenance information. |

ajsembdbstatus

Format

```
ajsembdbstatus
  {-s [ust|prc|usta] |
   -db [-d] |
   -l |
  -c}
  [-id embedded-database-setup-ID]
```

Format 1 (for monitoring the operating status of the embedded database 1)

```
ajsembdbstatus
  -s ust
  [-id embedded-database-setup-ID]
```

Format 2 (for monitoring the operating status of the embedded database 2)

```
ajsembdbstatus
  -s usta
  [-id embedded-database-setup-ID]
```

Format 3 (for monitoring the status of the processes of the embedded database)

```
ajsembdbstatus
  -s prc
  [-id embedded-database-setup-ID]
```

Format 4 (for monitoring the database areas in the embedded database)

```
ajsembdbstatus
  -db
  [-d]
  [-id embedded-database-setup-ID]
```

Format 5 (for monitoring the system log of the embedded database)

```
ajsembdbstatus
  -l
  [-id embedded-database-setup-ID]
```

Format 6 (for outputting embedded database configuration information)

```
ajsembdbstatus
  -c
  [-id embedded-database-setup-ID]
```

Description

Monitors the embedded database. You can monitor the following items:

- Operating status of the embedded database

- Status of the processes of the embedded database
- Database areas in the embedded database
- System log of the embedded database

To monitor the database areas in the embedded database (by specifying the `-db` option) or the status of the processes of the embedded database (by specifying the `-s prc` option), execute the command while the embedded database is running. In other cases, you can execute the command regardless of the operating status of the embedded database.

You can execute the command regardless of the operating status of JP1/AJS3.

Execution privileges

In Windows: Administrators privileges

In UNIX: Superuser privileges

Storage directory

In Windows:

JP1/AJS3 - Manager-installation-folder\tools

In UNIX:

/opt/jp1ajs2/tools/

Arguments

-s {ust|prc|usta}

Specify this option to monitor the status of the embedded database.

- `ust`
Specify this option to display the operating status of the embedded database, including the start and stop status of the embedded database.
- `prc`
Specify this option to display the status of the processes of the embedded database.
Use this option to check whether a command that manipulates the embedded database is accessing the embedded database. You can also use the option to acquire the name of the server or the program that you need when you want to cancel the command that is accessing the embedded database. You can then use the `ajsembdbcancel` command to cancel the command.
- `usta`
Specify this option to display the embedded database start status related to system area restoration in addition to the information displayed by the `ust` option.

-db

Specify this option to monitor the database areas in the embedded database.

Use this option to check the time of maintenance or the status of the database areas.

-d

Specify this option to display detailed information about the database.

When you specify this option, you can check the number of pages that can be released by using the `ajsembdbreclaim` command.

-l

Specify this option to monitor the system log of the embedded database.

Use this option to check the status of the system log file when you back up or restore the embedded database.

-c

Outputs the configuration information for the embedded database.

This option is used during setup for cluster use, to check the embedded database data area directory when the embedded database is backed up or restored and to check if the settings of the primary node and the secondary node are correct. Note, however, that this option is valid only if the command is executed for a embedded database built in JP1/AJS3 version 10-00 or later. If it is executed for the embedded database built in version 09-50 or earlier, the KAVS2129-I message appears and the command ends abnormally.

-id *embedded-database-setup-ID*

Specify the setup identifier that identifies the embedded database in the `_JFn` format (*n*: 0-9 or A-Z). The value specified in this argument must be the same as the value specified in the `-id` option of the `ajsembdbbuild` command.

If you want to operate an embedded database created by using the `jajs_setup`, `jajs_setup_cluster`, and `jajs_migrate` commands, use the `ajsembdbidlist` command to check the setup identifier of the embedded database. For details on the `ajsembdbidlist` command, see [ajsembdbidlist](#) in *2. Commands Used during Setup*.

If you omit this option, the system assumes `_JF0`.

Notes

- This command is implemented by a script. If you specify an excessively long character string or an invalid character string or value for an option, an unexpected error might occur. You must use the number of characters allowed for a character string or a value in the option as specified in the DBMS and JP1/AJS3 specifications.
- When you execute the `ajsembdbstatus` command with the `-db` option or the `-l` option specified while JP1/AJS3 is running, the output information might not be the latest information. To acquire the latest information when you execute the command, you need to execute the command while no operation (such as the definition and execution of a job) is being performed for a unit.
- Note that if multiple `ajsembdbstatus` commands are executed concurrently for a single embedded database, a conflict might occur during log output processing, and the following message might be output between lines in the output result:

```
The process cannot access the file. The file is being used by
another process.
```

You can ignore this message because there are no problems with the output results.

Return values

| | |
|----------|---|
| 0 | Normal end |
| 1 | The embedded database is being started or stopped |
| 2 | The embedded database is being stopped |
| 4, 8, 12 | Abnormal end |

| | |
|----|---|
| 16 | Windows The embedded database is inactive UNIX The pdprcd process is being stopped |
|----|---|

Actions to be taken if an error occurs

If a command error occurs, take the indicated action in the following table.

| Message | Cause | Action to be taken |
|------------|--|--|
| KAVS0996-E | The specified option contains an error. | Check the specification of the option. |
| KAVS2101-E | The embedded database is inactive. | Start the embedded database and then re-execute the command. |
| KAVS2102-E | The embedded database is being started or stopped. | Use the <code>-s ust</code> option of the <code>ajsembdbstatus</code> command to check whether the embedded database is running and then re-execute the command. |
| KAVS2104-E | The embedded database is not set up. | Set up the embedded database and then re-execute the command. |
| KAVS2116-E | The specified option contains an error. | Check the option output in the message and then re-execute the command. |
| KAVS2117-E | An error occurred during execution of the command. | Check the message output in the maintenance information. |

Output example

Checking the operating status of the embedded database

```
ajsembdbstatus -s usta -id _JF0

HOSTNAME      : 127.0.0.1 (144852)
SYSTEMID      : ajs2
UNITID        : unt1
ENTRYHOST     : 127.0.0.1
PAIRHOST      :
UNIT-STAT     FES-STAT  SETUP-STAT
ONLINE        *****  SETUP
START-OPT     : NORMAL
```

HOSTNAME

127.0.0.1 is displayed.

The item in parentheses is the hour, minutes, and seconds (format: *HHMMSS*) of the time when the `ajsembdbstatus` command is executed.

Cautionary note

If any of the conditions below is met, the host name of the embedded database installation directory is output by using no more than 32 characters. In a cluster configuration, the first host name that is set as the active server is output.

- When JP1/AJS3 - Manager for Windows version 09-50 or earlier is used and the embedded database has been built on a logical host
- When JP1/AJS3 - Manager for UNIX version 09-50 or earlier is used

- When JP1/AJS3 - Manager version 09-50 or earlier is updated to version 10-00 or later, and IPv6 has not been set up

SYSTEMID

Indicates the identifier of the embedded database with up to four characters. For JP1/AJS3, this identifier is fixed to `ajs2`.

UNITID

Indicates the system-specific identifier with up to four characters. For JP1/AJS3, this identifier is fixed to `unt1`.

ENTRYHOST

`127.0.0.1` is displayed.

Cautionary note

If any of the following conditions is met, the name of the host on which the `ajsembddbstatus` command is executed is output:

- When JP1/AJS3 - Manager for Windows version 09-50 or earlier is used and the embedded database has been built on a logical host
- When JP1/AJS3 - Manager for UNIX version 09-50 or earlier is used
- When JP1/AJS3 - Manager version 09-50 or earlier is updated to version 10-00 or later, and IPv6 has not been set up

PAIRHOST

Always blank.

UNIT-STAT

Indicates the system status.

PAUSE: The restart of the embedded database is suspended.#

STOP: The embedded database is stopped.

STARTING: The embedded database is being started.

ONLINE: The embedded database is running.

STOPPING: The embedded database is being stopped.

#

The embedded database has terminated abnormally and cannot be restored by its automatic restart function.

FES-STAT

Always `*****`.

SETUP-STAT

Indicates the setup status.

SETUP:

In Windows, this indicates that execution of the `ajsembddbbuild` command has been completed and the embedded database service is running. In UNIX, this indicates that execution of the `ajsembddbbuild` command has been completed.

UNSETUP:

In Windows, this indicates that the embedded database service is not running. In UNIX, this indicates that execution of the `ajsembdbunset` command with the `-r` option specified has been completed.

START-OPT(output only if the `-s usta` option was specified)

Indicates the start status of the embedded database.

NORMAL: The embedded database is starting normally.

RECOVERY: The embedded database is starting for system area recovery (the `ajsembdbstart` command with the `-r` option specified).

*****: The embedded database is not starting.

Checking the status of the processes of the embedded database

```
ajsembdbstatus -s prc -id _JF0

HOSTNAME : 127.0.0.1(110440)
STATUS  PID  UID  GID  SVID  TIME      PROGRAM  C-PID      C-GRP
L       856   0    0    ajs2  102826   ajsschd  3568 (XXX.YYY...)
L       1868  0    0    ajs2  102832   ajsflowd 3604 (XXX.YYY...)
L       2080  0    0    ajs2  102835   ajssubd  3792 (XXX.YYY...)
L       2116  0    0    ajs2  999999
L       2136  0    0    ajs2  999999
:
```

HOSTNAME

127.0.0.1 is displayed.

The item in parentheses is the hour, minutes, and seconds (format: *HHMMSS*) of the time when the `ajsembdbstatus` command is executed.

Cautionary note

If any of the conditions below is met, the host name of the embedded database installation directory is output by using no more than 32 characters. In a cluster configuration, the first host name that is set as the active server is output.

- When JP1/AJS3 - Manager for Windows version 09-50 or earlier is used and the embedded database has been built on a logical host
- When JP1/AJS3 - Manager for UNIX version 09-50 or earlier is used
- When JP1/AJS3 - Manager version 09-50 or earlier is updated to version 10-00 or later, and IPv6 has not been set up

STATUS

Indicates the status of the process for accessing started by the embedded database.

D: The process is being started or being terminated.

L: The process is running.

PID

Indicates the process ID using a decimal number of 10 digits or less.

UID

Always 0.

GID

Always 0.

SVID

Indicates the name of the server for the process. For the processes used by JP1/AJS3, this name is `ajs2`. When an embedded database operation command is executed, the information that is specified in the `-u` option of the `ajsembdbcancel` command might be output.

TIME

Indicates the time when the embedded database is connected in the *HHMMSS* (hour, minutes, seconds) format.

PROGRAM

Indicates the name of a command or a daemon of JP1/AJS3 with up to 30 characters.

When an embedded database operation command is executed, the name of a command, other than the executed command, might be output. The information you specify in the `-u` option in the `ajsembdbcancel` command is output here.

C-PID

Indicates the process ID of the JP1/AJS3 daemon process or command process connected to the embedded database by using a decimal number of 10 digits or less. The item in parentheses is the IP address up to 15 characters.

This item is not output for the process that is not connected.

C-GRP

Always blank.

Checking the status of the database areas in the embedded database

```
ajsembdbstatus -db -id _JF0

1684 hh:mm:ss unt1 _pd0dbst KFPK10300-I Pddbst started
1684 hh:mm:ss unt1 _pd0dbst KFPK10301-I Pddbst terminated, return code=0
pddbst 08-05(Object Option) ** RD Area Logical Analysis ** YYYY/MM/DD hh:m
m:ss
RD Area Name   : AJS2DATA
Server        : ajs2
Total Segment :      301   Segment Size :      10 Pages
Unused Segment:      297   Page Size   :     30720 Bytes
History1 Hold Status :      Hold Code :      0   Hold Time :
History2 Hold Status :      Hold Code :      0   Hold Time :
-----
Table Name : AJS1ARROW
Auth Id   : root
Status    :
Reference Pending Status :
Check Pending Status :
Segment Reuse :      18 segments
<Base row segment>
Search Mode : INS
Reuse Search Failure :      0/      0
      (1)Used(Full)      (2)Used(      Full)      Sum
Segment  0%( 0%)      0(      0)      0
Page     0%( 0%)      0(      0)      0
Collect On Segment :      0

Table Name : AJS1BODY
Auth Id   : root
Status    :
Reference Pending Status :
Check Pending Status :
Segment Reuse :      18 segments
<Base row segment>
Search Mode : INS
Reuse Search Failure :      0/      0
      Used(Full)      Used(      Full)      Sum
Segment  0%( 0%)      0(      0)      0
Page     0%( 0%)      0(      0)      0
Collect On Segment :      0
```

```

Table Name : AJS1CAL
Auth Id    : root
Status     :
Reference Pending Status :
Check      Pending Status :
Segment Reuse :      18 segments
<Base row segment>
Search Mode : INS
Reuse Search Failure :      0/      0
      Used(Full)      Used(      Full)      Sum
Segment  0%( 0%)      0(      0)      0
Page     0%( 0%)      0(      0)      0
Collect On Segment :      0

```

```

Table Name : AJS1ENTRY
Auth Id    : root
Status     :
Reference Pending Status :
Check      Pending Status :
Segment Reuse :      18 segments
<Base row segment>
Search Mode : INS
Reuse Search Failure :      0/      0
      Used(Full)      Used(      Full)      Sum
Segment  0%( 0%)      0(      0)      0
Page     0%( 0%)      0(      0)      0
Collect On Segment :      0

```

```

Table Name : AJS1GEN
Auth Id    : root
Status     :
Reference Pending Status :
Check      Pending Status :
Segment Reuse :      18 segments
<Base row segment>
Search Mode : INS
Reuse Search Failure :      0/      0
      Used(Full)      Used(      Full)      Sum
Segment  0%( 0%)      0(      0)      0
Page     0%( 0%)      0(      0)      0
Collect On Segment :      0

```

```

Table Name : AJS1ID
Auth Id    : root
Status     :
Reference Pending Status :
Check      Pending Status :
Segment Reuse :      18 segments
<Base row segment>
Search Mode : INS
Reuse Search Failure :      0/      0
      Used(Full)      Used(      Full)      Sum
Segment 100%( 0%)      1(      0)      1
Page    10%( 0%)      1(      0)      10
Collect On Segment :      0

```

```

Table Name : AJS1PERF
Auth Id    : root

```



```

Status      :
Reference Pending Status :
Check       Pending Status :
Segment Reuse :          18 segments
<Base row segment>
Search Mode : INS
Reuse Search Failure :          0/          0
      Used(Full)      Used(      Full)      Sum
Segment  0%(  0%)      0(      0)          0
Page     0%(  0%)      0(      0)          0
Collect On Segment :          0

```

```

Table Name : AJS1RELS
Auth Id    : root
Status     :
Reference Pending Status :
Check      Pending Status :
Segment Reuse :          18 segments
<Base row segment>
Search Mode : INS
Reuse Search Failure :          0/          0
      Used(Full)      Used(      Full)      Sum
Segment  0%(  0%)      0(      0)          0
Page     0%(  0%)      0(      0)          0
Collect On Segment :          0

```

```

Table Name : AJS1SCH
Auth Id    : root
Status     :
Reference Pending Status :
Check      Pending Status :
Segment Reuse :          18 segments
<Base row segment>
Search Mode : INS
Reuse Search Failure :          0/          0
      Used(Full)      Used(      Full)      Sum
Segment  0%(  0%)      0(      0)          0
Page     0%(  0%)      0(      0)          0
Collect On Segment :          0

```

```

Table Name : AJS1STAT
Auth Id    : root
Status     :
Reference Pending Status :
Check      Pending Status :
Segment Reuse :          48 segments
<Base row segment>
Search Mode : INS
Reuse Search Failure :          0/          0
      Used(Full)      Used(      Full)      Sum
Segment  0%(  0%)      0(      0)          0
Page     0%(  0%)      0(      0)          0
Collect On Segment :          0

```

```

Table Name : AJS1UNIT
Auth Id    : root
Status     :
Reference Pending Status :

```

```

Check      Pending Status :
Segment Reuse :          18 segments
<Base row segment>
Search Mode : INS
Reuse Search Failure :          0/          0
      Used(Full)          Used(          Full)          Sum
Segment 100%( 0%)          1(          0)          1
Page    10%( 0%)          1(          0)          10
Collect On Segment :          0

```

```

Table Name : AJSAGTEXECNT
Auth Id    : root
Status     :
Reference Pending Status :
Check      Pending Status :
Segment Reuse :          3 segments
<Base row segment>
Search Mode : INS
Reuse Search Failure :          0/          0
      Used(Full)          Used(          Full)          Sum
Segment 100%( 0%)          1(          0)          1
Page    10%( 0%)          1(          0)          10
Collect On Segment :          0

```

```

Table Name : AJSEXCAGT
Auth Id    : root
Status     :
Reference Pending Status :
Check      Pending Status :
Segment Reuse :          3 segments
<Base row segment>
Search Mode : INS
Reuse Search Failure :          0/          0
      Used(Full)          Used(          Full)          Sum
Segment 100%( 0%)          1(          0)          1
Page    10%( 0%)          1(          0)          10
Collect On Segment :          0

```

```

Table Name : AJSEXCAGTGRP
Auth Id    : root
Status     :
Reference Pending Status :
Check      Pending Status :
Segment Reuse :          3 segments
<Base row segment>
Search Mode : INS
Reuse Search Failure :          0/          0
      Used(Full)          Used(          Full)          Sum
Segment  0%( 0%)          0(          0)          0
Page    0%( 0%)          0(          0)          0
Collect On Segment :          0

```

```

Table Name : AJSLINKAGT
Auth Id    : root
Status     :
Reference Pending Status :
Check      Pending Status :
Segment Reuse :          3 segments

```

<Base row segment>

Search Mode : INS

Reuse Search Failure : 0/ 0

| | Used(Full) | Used(| Full) | Sum |
|----------------------|------------|-------|-------|-----|
| Segment | 0%(0%) | 0(| 0) | 0 |
| Page | 0%(0%) | 0(| 0) | 0 |
| Collect On Segment : | | 0 | | |

3649 hh:mm:ss until _pd0dbst KFPK10300-I Pddbst started

3649 hh:mm:ss until _pd0dbst KFPK10301-I Pddbst terminated, return code=0

pddbst 08-05(Object Option) ** RD Area Logical Analysis ** YYYY/MM/DD hh:m
m:ss

RD Area Name : AJS2DATA2

Server : ajs2

Total Segment : 100 Segment Size : 100 Pages

Unused Segment: 100 Page Size : 30720 Bytes

History1 Hold Status : Hold Code : 0 Hold Time :

History2 Hold Status : Hold Code : 0 Hold Time :

Table Name : AJS1JINF

Auth Id : root

Status :

Reference Pending Status :

Check Pending Status :

Segment Reuse : 70 segments

<Base row segment>

Search Mode : INS

Reuse Search Failure : 0/ 0

| | Used(Full) | Used(| Full) | Sum |
|----------------------|------------|-------|-------|-----|
| Segment | 0%(0%) | 0(| 0) | 0 |
| Page | 0%(0%) | 0(| 0) | 0 |
| Collect On Segment : | | 0 | | |

<BINARY segment>

Search Mode : INS

Reuse Search Failure : 0/ 0

| | Used(Full) | Used(| Full) | Sum |
|----------------------|------------|-------|-------|-----|
| Segment | 0%(0%) | 0(| 0) | 0 |
| Page | 0%(0%) | 0(| 0) | 0 |
| Collect On Segment : | | 0 | | |

3952 hh:mm:ss until _pd0dbst KFPK10300-I Pddbst started

3952 hh:mm:ss until _pd0dbst KFPK10301-I Pddbst terminated, return code=0

pddbst 08-05(Object Option) ** RD Area Logical Analysis ** YYYY/MM/DD hh:m
m:ss

RD Area Name : AJS2INDX

Server : ajs2

Total Segment : 904 Segment Size : 10 Pages

Unused Segment: 885 Page Size : 4096 Bytes

History1 Hold Status : Hold Code : 0 Hold Time :

History2 Hold Status : Hold Code : 0 Hold Time :

Index Name : AJS1ARROWINDEX1

Auth Id : root

Status :

| | Used(Full) | Used(| Full) | Sum |
|----------------------|------------|-------|-------|-----|
| Segment | 100%(0%) | 1(| 0) | 1 |
| Page | 10%(0%) | 1(| 0) | 10 |
| Collect On Segment : | | 0 | | |

```

Index Name : AJS1BODYINDEX1
Auth Id    : root
Status     :
           Used(Full)      Used(      Full)      Sum
Segment 100%( 0%)         1(        0)         1
Page     10%( 0%)         1(        0)         10
Collect On Segment :           0

```

```

Index Name : AJS1CALINDEX1
Auth Id    : root
Status     :
           Used(Full)      Used(      Full)      Sum
Segment 100%( 0%)         1(        0)         1
Page     10%( 0%)         1(        0)         10
Collect On Segment :           0

```

```

Index Name : AJS1ENTRYINDEX1
Auth Id    : root
Status     :
           Used(Full)      Used(      Full)      Sum
Segment 100%( 0%)         1(        0)         1
Page     10%( 0%)         1(        0)         10
Collect On Segment :           0

```

```

Index Name : AJS1GENINDEX1
Auth Id    : root
Status     :
           Used(Full)      Used(      Full)      Sum
Segment 100%( 0%)         1(        0)         1
Page     10%( 0%)         1(        0)         10
Collect On Segment :           0

```

```

Index Name : AJS1IDINDEX1
Auth Id    : root
Status     :
           Used(Full)      Used(      Full)      Sum
Segment 100%( 0%)         1(        0)         1
Page     10%( 0%)         1(        0)         10
Collect On Segment :           0

```

```

Index Name : AJS1PERFINDEX1
Auth Id    : root
Status     :
           Used(Full)      Used(      Full)      Sum
Segment 100%( 0%)         1(        0)         1
Page     10%( 0%)         1(        0)         10
Collect On Segment :           0

```

```

Index Name : AJS1PERFINDEX2
Auth Id    : root
Status     :
           Used(Full)      Used(      Full)      Sum
Segment 100%( 0%)         1(        0)         1
Page     10%( 0%)         1(        0)         10
Collect On Segment :           0

```

```

Index Name : AJS1RELSINDEX1

```

```

Auth Id      : root
Status      :
              Used(Full)      Used(      Full)      Sum
Segment 100%( 0%)      1(      0)      1
Page      10%( 0%)      1(      0)      10
Collect On Segment :      0

```

```

Index Name : AJS1RELSINDEX2
Auth Id    : root
Status     :
              Used(Full)      Used(      Full)      Sum
Segment 100%( 0%)      1(      0)      1
Page      10%( 0%)      1(      0)      10
Collect On Segment :      0

```

```

Index Name : AJS1RELSINDEX3
Auth Id    : root
Status     :
              Used(Full)      Used(      Full)      Sum
Segment 100%( 0%)      1(      0)      1
Page      10%( 0%)      1(      0)      10
Collect On Segment :      0

```

```

Index Name : AJS1SCHINDEX1
Auth Id    : root
Status     :
              Used(Full)      Used(      Full)      Sum
Segment 100%( 0%)      1(      0)      1
Page      10%( 0%)      1(      0)      10
Collect On Segment :      0

```

```

Index Name : AJS1STATINDEX1
Auth Id    : root
Status     :
              Used(Full)      Used(      Full)      Sum
Segment 100%( 0%)      1(      0)      1
Page      10%( 0%)      1(      0)      10
Collect On Segment :      0

```

```

Index Name : AJS1UNITINDEX1
Auth Id    : root
Status     :
              Used(Full)      Used(      Full)      Sum
Segment 100%( 0%)      1(      0)      1
Page      10%( 0%)      1(      0)      10
Collect On Segment :      0

```

```

Index Name : AJS1UNITINDEX2
Auth Id    : root
Status     :
              Used(Full)      Used(      Full)      Sum
Segment 100%( 0%)      1(      0)      1
Page      10%( 0%)      1(      0)      10
Collect On Segment :      0

```

```

Index Name : AJSAGTEXECCNTINDEX1
Auth Id    : root
Status     :

```

| | Used(Full) | Used(| Full) | Sum |
|----------------------|------------|-------|-------|-----|
| Segment | 100%(0%) | 1(| 0) | 1 |
| Page | 10%(0%) | 1(| 0) | 10 |
| Collect On Segment : | | 0 | | |

Index Name : AJSEXCAGTGRPINDEX1
Auth Id : root
Status :

| | Used(Full) | Used(| Full) | Sum |
|----------------------|------------|-------|-------|-----|
| Segment | 100%(0%) | 1(| 0) | 1 |
| Page | 10%(0%) | 1(| 0) | 10 |
| Collect On Segment : | | 0 | | |

Index Name : AJSEXCAGTINDEX1
Auth Id : root
Status :

| | Used(Full) | Used(| Full) | Sum |
|----------------------|------------|-------|-------|-----|
| Segment | 100%(0%) | 1(| 0) | 1 |
| Page | 10%(0%) | 1(| 0) | 10 |
| Collect On Segment : | | 0 | | |

Index Name : AJSLINKAGTINDEX1
Auth Id : root
Status :

| | Used(Full) | Used(| Full) | Sum |
|----------------------|------------|-------|-------|-----|
| Segment | 100%(0%) | 1(| 0) | 1 |
| Page | 10%(0%) | 1(| 0) | 10 |
| Collect On Segment : | | 0 | | |

3667 hh:mm:ss unt1 _pd0dbst KFPK10300-I Pddbst started
3667 hh:mm:ss unt1 _pd0dbst KFPK10301-I Pddbst terminated, return code=0
pddbst 08-05(Object Option) ** RD Area Logical Analysis ** YYYY/MM/DD hh:m
m:ss

RD Area Name : AJS2INDX2
Server : ajs2
Total Segment : 3000 Segment Size : 10 Pages
Unused Segment: 2998 Page Size : 4096 Bytes
History1 Hold Status : Hold Code : 0 Hold Time :
History2 Hold Status : Hold Code : 0 Hold Time :

Index Name : AJS1JINFINDEX1
Auth Id : root
Status :

| | Used(Full) | Used(| Full) | Sum |
|----------------------|------------|-------|-------|-----|
| Segment | 100%(0%) | 1(| 0) | 1 |
| Page | 10%(0%) | 1(| 0) | 10 |
| Collect On Segment : | | 0 | | |

Index Name : AJS1JINFINDEX2
Auth Id : root
Status :

| | Used(Full) | Used(| Full) | Sum |
|----------------------|------------|-------|-------|-----|
| Segment | 100%(0%) | 1(| 0) | 1 |
| Page | 10%(0%) | 1(| 0) | 10 |
| Collect On Segment : | | 0 | | |

RD Area Name

Indicates the name of the area used by JP1/AJS3.

AJS2DATA, AJS2DATA2#: Table area

AJS2INDX, AJS2INDX2#: Index area

#:

AJS2DATA2 and AJS2INDX2 information is output only if the backup enhancement function is enabled.

Server

Always ajs2.

Total Segment

Indicates the total number of segments in the indicated area.

Unused Segment

Indicates the total number of unused segments in the indicated area.

Segment Size

Indicates the number of pages in one segment.

Page Size

Indicates the size of one page in bytes.

History1 Hold Status Code, Hold Code, Hold Time

Information used by the system.

History2 Hold Status Code, Hold Code, Hold Time

Information used by the system.

Table Name

Indicates the name of the table used by JP1/AJS3.

Index Name

Indicates the name of the index used by JP1/AJS3.

Auth Id

Indicates the authorization identifier for the table or the index. For JP1/AJS3, this is usually root.

Segment Reuse

The value specified for the reuse start point (the number of segments) for the free-space reuse function is output. If the free-space reuse function is disabled, a hyphen (-) is output.

Collect On Segment

The output value is the number of segments in the state in which release processing is incomplete because the ajsembdbreclaim command is being executed or because the ajsembdbreclaim command did not end normally.

Status, Reference Pending Status, Check Pending Status, Search Mode, Reuse Search Failure

Information used by the system.

(1) Used (Full)

Indicates the percentage of the segments or pages being used. The number in parentheses indicates the percentage of full segments or pages in all the segments or pages being used.

(2) Used (Full)

Indicates the number of segments or pages being used. The number in parentheses indicates the number of full segments or pages in all the segments or pages being used.

Sum

Indicates the total number of segments or pages allocated to the table or the index.

Checking the details about the database areas in the embedded database

```
ajsembdbstatus -db -d -id _JF0

3240 hh:mm:ss unt1 _pd0dbst KFPK10300-I Pddbst started
3240 hh:mm:ss unt1 _pd0dbst KFPK10301-I Pddbst terminated, return code=0
pddbst 08-05(Object Option) ** RD Area Logical Analysis ** YYYY/MM/DD hh:m
m:ss
RD Area Name      : AJS2DATA
Server            : ajs2
Total Segment     301   Segment Size :          10 Pages
Unused Segment:   297   Page Size   :        30720 Bytes
History1 Hold Status :      Hold Code :    0 Hold Time :
History2 Hold Status :      Hold Code :    0 Hold Time :
-----
Table Name : AJS1ARROW
Auth Id    : root
Status     :
Reference Pending Status :
Check      Pending Status :
Segment Reuse :      18 segments
<Base row segment>
Search Mode : INS
Reuse Search Failure :          0/          0
      Used(Full)      Used(      Full)      Sum
Segment  0%( 0%)      0(          0)      0
Page     0%( 0%)      0(          0)      0
Collect On Segment :          0
Collect Prearranged Page :          0
Used Page Ratio      Page(Ratio)
      0% :          0( 0%)
      1- 10% :          0( 0%)
      11- 20% :          0( 0%)
      21- 30% :          0( 0%)
      31- 40% :          0( 0%)
      41- 50% :          0( 0%)
      51- 60% :          0( 0%)
      61- 70% :          0( 0%)
      71- 80% :          0( 0%)
      81- 90% :          0( 0%)
      91-100% :          0( 0%)
Total                                0

Table Name : AJS1BODY
Auth Id    : root
Status     :
Reference Pending Status :
Check      Pending Status :
Segment Reuse :      18 segments
<Base row segment>
Search Mode : INS
Reuse Search Failure :          0/          0
      Used(Full)      Used(      Full)      Sum
Segment  0%( 0%)      0(          0)      0
Page     0%( 0%)      0(          0)      0
```



```

Collect On Segment :          0
Collect Prearranged Page :    0
Used Page Ratio      Page(Ratio)
  0% :                0( 0%)
  1- 10% :            0( 0%)
 11- 20% :            0( 0%)
 21- 30% :            0( 0%)
 31- 40% :            0( 0%)
 41- 50% :            0( 0%)
 51- 60% :            0( 0%)
 61- 70% :            0( 0%)
 71- 80% :            0( 0%)
 81- 90% :            0( 0%)
 91-100% :           0( 0%)
Total                0

```

```

Table Name : AJS1CAL
Auth Id    : root
Status     :
Reference Pending Status :
Check      Pending Status :
Segment Reuse :      18 segments

```

```

<Base row segment>
Search Mode : INS
Reuse Search Failure :      0/      0
  Used(Full)      Used(      Full)      Sum
Segment  0%( 0%)      0(      0)      0
Page     0%( 0%)      0(      0)      0

```

```

Collect On Segment :          0
Collect Prearranged Page :    0
Used Page Ratio      Page(Ratio)
  0% :                0( 0%)
  1- 10% :            0( 0%)
 11- 20% :            0( 0%)
 21- 30% :            0( 0%)
 31- 40% :            0( 0%)
 41- 50% :            0( 0%)
 51- 60% :            0( 0%)
 61- 70% :            0( 0%)
 71- 80% :            0( 0%)
 81- 90% :            0( 0%)
 91-100% :           0( 0%)
Total                0

```

```

Table Name : AJS1ENTRY
Auth Id    : root
Status     :
Reference Pending Status :
Check      Pending Status :
Segment Reuse :      18 segments

```

```

<Base row segment>
Search Mode : INS
Reuse Search Failure :      0/      0
  Used(Full)      Used(      Full)      Sum
Segment  0%( 0%)      0(      0)      0
Page     0%( 0%)      0(      0)      0

```

```

Collect On Segment :          0
Collect Prearranged Page :    0

```

```

Used Page Ratio      Page(Ratio)
  0% :                0(  0%)
  1- 10% :            0(  0%)
 11- 20% :            0(  0%)
 21- 30% :            0(  0%)
 31- 40% :            0(  0%)
 41- 50% :            0(  0%)
 51- 60% :            0(  0%)
 61- 70% :            0(  0%)
 71- 80% :            0(  0%)
 81- 90% :            0(  0%)
 91-100% :           0(  0%)
Total                0

```

```

Table Name : AJS1GEN
Auth Id    : root
Status     :
Reference Pending Status :
Check      Pending Status :
Segment Reuse :      18 segments

```

```

<Base row segment>
Search Mode : INS
Reuse Search Failure :      0/      0
      Used(Full)      Used(      Full)      Sum
Segment  0%(  0%)      0(      0)      0
Page     0%(  0%)      0(      0)      0
Collect On Segment :      0
Collect Prearranged Page :      0

```

```

Used Page Ratio      Page(Ratio)
  0% :                0(  0%)
  1- 10% :            0(  0%)
 11- 20% :            0(  0%)
 21- 30% :            0(  0%)
 31- 40% :            0(  0%)
 41- 50% :            0(  0%)
 51- 60% :            0(  0%)
 61- 70% :            0(  0%)
 71- 80% :            0(  0%)
 81- 90% :            0(  0%)
 91-100% :           0(  0%)
Total                0

```

```

Table Name : AJS1ID
Auth Id    : root
Status     :
Reference Pending Status :
Check      Pending Status :
Segment Reuse :      18 segments

```

```

<Base row segment>
Search Mode : INS
Reuse Search Failure :      0/      0
      Used(Full)      Used(      Full)      Sum
Segment 100%(  0%)      1(      0)      1
Page     10%(  0%)      1(      0)      10
Collect On Segment :      0
Collect Prearranged Page :      0

```

```

Used Page Ratio      Page(Ratio)
  0% :                9( 90%)

```

```

    1- 10% :          1 ( 10%)
    11- 20% :         0 (  0%)
    21- 30% :         0 (  0%)
    31- 40% :         0 (  0%)
    41- 50% :         0 (  0%)
    51- 60% :         0 (  0%)
    61- 70% :         0 (  0%)
    71- 80% :         0 (  0%)
    81- 90% :         0 (  0%)
    91-100% :        0 (  0%)
Total                               10

```

```

Table Name : AJS1PERF
Auth Id    : root
Status     :
Reference Pending Status :
Check      Pending Status :
Segment Reuse :      18 segments

```

```

<Base row segment>
Search Mode : INS
Reuse Search Failure :          0/          0
      Used(Full)      Used(      Full)      Sum
Segment  0%(  0%)      0(          0)          0
Page     0%(  0%)      0(          0)          0
Collect On Segment :          0
Collect Prearranged Page :          0
Used Page Ratio      Page(Ratio)
    0% :          0(  0%)
    1- 10% :        0(  0%)
    11- 20% :        0(  0%)
    21- 30% :        0(  0%)
    31- 40% :        0(  0%)
    41- 50% :        0(  0%)
    51- 60% :        0(  0%)
    61- 70% :        0(  0%)
    71- 80% :        0(  0%)
    81- 90% :        0(  0%)
    91-100% :       0(  0%)
Total                               0

```

```

Table Name : AJS1RELS
Auth Id    : root
Status     :
Reference Pending Status :
Check      Pending Status :
Segment Reuse :      18 segments

```

```

<Base row segment>
Search Mode : INS
Reuse Search Failure :          0/          0
      Used(Full)      Used(      Full)      Sum
Segment  0%(  0%)      0(          0)          0
Page     0%(  0%)      0(          0)          0
Collect On Segment :          0
Collect Prearranged Page :          0
Used Page Ratio      Page(Ratio)
    0% :          0(  0%)
    1- 10% :        0(  0%)
    11- 20% :        0(  0%)

```

```

21- 30% :          0 ( 0%)
31- 40% :          0 ( 0%)
41- 50% :          0 ( 0%)
51- 60% :          0 ( 0%)
61- 70% :          0 ( 0%)
71- 80% :          0 ( 0%)
81- 90% :          0 ( 0%)
91-100% :          0 ( 0%)
Total                0

```

```

Table Name : AJS1SCH
Auth Id    : root
Status     :
Reference Pending Status :
Check      Pending Status :
Segment Reuse :      18 segments

```

```

<Base row segment>
Search Mode : INS
Reuse Search Failure :          0/          0
      Used(Full)      Used(      Full)      Sum
Segment  0%( 0%)      0(          0)          0
Page     0%( 0%)      0(          0)          0
Collect On Segment :          0
Collect Prearranged Page :          0
Used Page Ratio      Page(Ratio)
  0% :          0 ( 0%)
  1- 10% :          0 ( 0%)
 11- 20% :          0 ( 0%)
 21- 30% :          0 ( 0%)
 31- 40% :          0 ( 0%)
 41- 50% :          0 ( 0%)
 51- 60% :          0 ( 0%)
 61- 70% :          0 ( 0%)
 71- 80% :          0 ( 0%)
 81- 90% :          0 ( 0%)
 91-100% :          0 ( 0%)
Total                0

```

```

Table Name : AJS1STAT
Auth Id    : root
Status     :
Reference Pending Status :
Check      Pending Status :
Segment Reuse :      48 segments

```

```

<Base row segment>
Search Mode : INS
Reuse Search Failure :          0/          0
      Used(Full)      Used(      Full)      Sum
Segment  0%( 0%)      0(          0)          0
Page     0%( 0%)      0(          0)          0
Collect On Segment :          0
Collect Prearranged Page :          0
Used Page Ratio      Page(Ratio)
  0% :          0 ( 0%)
  1- 10% :          0 ( 0%)
 11- 20% :          0 ( 0%)
 21- 30% :          0 ( 0%)
 31- 40% :          0 ( 0%)

```

```

41- 50% :      0 ( 0%)
51- 60% :      0 ( 0%)
61- 70% :      0 ( 0%)
71- 80% :      0 ( 0%)
81- 90% :      0 ( 0%)
91-100% :      0 ( 0%)
Total      0

```

```

Table Name : AJS1UNIT
Auth Id    : root
Status     :
Reference Pending Status :
Check      Pending Status :
Segment Reuse :      18 segments

```

```

<Base row segment>
Search Mode : INS
Reuse Search Failure :      0/      0
      Used(Full)      Used(      Full)      Sum
Segment 100%( 0%)      1(      0)      1
Page    10%( 0%)      1(      0)      10
Collect On Segment :      0
Collect Prearranged Page :      0
Used Page Ratio      Page(Ratio)
    0% :      9( 90%)
    1- 10% :      1( 10%)
    11- 20% :      0( 0%)
    21- 30% :      0( 0%)
    31- 40% :      0( 0%)
    41- 50% :      0( 0%)
    51- 60% :      0( 0%)
    61- 70% :      0( 0%)
    71- 80% :      0( 0%)
    81- 90% :      0( 0%)
    91-100% :      0( 0%)
Total      10

```

```

Table Name : AJSAGTEXECCNT
Auth Id    : root
Status     :
Reference Pending Status :
Check      Pending Status :
Segment Reuse :      3 segments

```

```

<Base row segment>
Search Mode : INS
Reuse Search Failure :      0/      0
      Used(Full)      Used(      Full)      Sum
Segment 100%( 0%)      1(      0)      1
Page    10%( 0%)      1(      0)      10
Collect On Segment :      0
Collect Prearranged Page :      0
Used Page Ratio      Page(Ratio)
    0% :      9( 90%)
    1- 10% :      1( 10%)
    11- 20% :      0( 0%)
    21- 30% :      0( 0%)
    31- 40% :      0( 0%)
    41- 50% :      0( 0%)
    51- 60% :      0( 0%)

```

```

61- 70% :          0 ( 0%)
71- 80% :          0 ( 0%)
81- 90% :          0 ( 0%)
91-100% :          0 ( 0%)
Total                10

```

Table Name : AJSEEXECAGT

Auth Id : root

Status :

Reference Pending Status :

Check Pending Status :

Segment Reuse : 3 segments

<Base row segment>

Search Mode : INS

Reuse Search Failure : 0/ 0

| | Used(Full) | Used(| Full) | Sum |
|-------------------|------------|-------|-------|-----|
| Segment 100%(0%) | 1(| 0) | 0) | 1 |
| Page 10%(0%) | 1(| 0) | 0) | 10 |

Collect On Segment : 0

Collect Prearranged Page : 0

Used Page Ratio Page(Ratio)

0% : 9(90%)

1- 10% : 1(10%)

11- 20% : 0(0%)

21- 30% : 0(0%)

31- 40% : 0(0%)

41- 50% : 0(0%)

51- 60% : 0(0%)

61- 70% : 0(0%)

71- 80% : 0(0%)

81- 90% : 0(0%)

91-100% : 0(0%)

Total 10

Table Name : AJSEEXECAGTGRP

Auth Id : root

Status :

Reference Pending Status :

Check Pending Status :

Segment Reuse : 3 segments

<Base row segment>

Search Mode : INS

Reuse Search Failure : 0/ 0

| | Used(Full) | Used(| Full) | Sum |
|-----------------|------------|-------|-------|-----|
| Segment 0%(0%) | 0(| 0) | 0) | 0 |
| Page 0%(0%) | 0(| 0) | 0) | 0 |

Collect On Segment : 0

Collect Prearranged Page : 0

Used Page Ratio Page(Ratio)

0% : 0(0%)

1- 10% : 0(0%)

11- 20% : 0(0%)

21- 30% : 0(0%)

31- 40% : 0(0%)

41- 50% : 0(0%)

51- 60% : 0(0%)

61- 70% : 0(0%)

71- 80% : 0(0%)

```

      81- 90% :          0(  0%)
      91-100% :          0(  0%)
Total                                     0

```

```

Table Name : AJSLINKAGT
Auth Id    : root
Status     :
Reference Pending Status :
Check      Pending Status :
Segment Reuse :          3 segments

```

```

<Base row segment>
Search Mode : INS
Reuse Search Failure :          0/          0
      Used(Full)          Used(          Full)          Sum
Segment  0%(  0%)          0(          0)          0
Page     0%(  0%)          0(          0)          0
Collect On Segment :          0
Collect Prearranged Page :          0
Used Page Ratio          Page(Ratio)
      0% :          0(  0%)
      1- 10% :          0(  0%)
      11- 20% :          0(  0%)
      21- 30% :          0(  0%)
      31- 40% :          0(  0%)
      41- 50% :          0(  0%)
      51- 60% :          0(  0%)
      61- 70% :          0(  0%)
      71- 80% :          0(  0%)
      81- 90% :          0(  0%)
      91-100% :          0(  0%)
Total                                     0

```

```

3711 hh:mm:ss until __pd0dbst KFPK10300-I Pddbst started
3711 hh:mm:ss until __pd0dbst KFPK10301-I Pddbst terminated, return code=0
pddbst 08-05(Object Option) ** RD Area Logical Analysis **   YYYY/MM/DD hh:m
m:ss

```

```

RD Area Name   : AJS2DATA2
Server         : ajs2
Total Segment :          100   Segment Size :          100 Pages
Unused Segment:          100   Page Size    :          30720 Bytes
History1 Hold Status :          Hold Code :          0   Hold Time :
History2 Hold Status :          Hold Code :          0   Hold Time :

```

```

-----
Table Name : AJS1JINF
Auth Id    : root
Status     :
Reference Pending Status :
Check      Pending Status :
Segment Reuse :          70 segments

```

```

<Base row segment>
Search Mode : INS
Reuse Search Failure :          0/          0
      Used(Full)          Used(          Full)          Sum
Segment  0%(  0%)          0(          0)          0
Page     0%(  0%)          0(          0)          0
Collect On Segment :          0
Collect Prearranged Page :          0
Used Page Ratio          Page(Ratio)

```

```

    0% :          0(  0%)
    1- 10% :       0(  0%)
   11- 20% :       0(  0%)
   21- 30% :       0(  0%)
   31- 40% :       0(  0%)
   41- 50% :       0(  0%)
   51- 60% :       0(  0%)
   61- 70% :       0(  0%)
   71- 80% :       0(  0%)
   81- 90% :       0(  0%)
   91-100% :      0(  0%)

```

Total

0

<BINARY segment>

Search Mode : INS

Reuse Search Failure : 0/ 0

| | Used(Full) | Used(| Full) | Sum |
|---------|------------|-------|-------|-----|
| Segment | 0%(0%) | 0(| 0) | 0 |
| Page | 0%(0%) | 0(| 0) | 0 |

Collect On Segment : 0

Collect Prearranged Page : 0

Used Page Ratio Page(Ratio)

```

    0% :          0(  0%)
    1- 10% :       0(  0%)
   11- 20% :       0(  0%)
   21- 30% :       0(  0%)
   31- 40% :       0(  0%)
   41- 50% :       0(  0%)
   51- 60% :       0(  0%)
   61- 70% :       0(  0%)
   71- 80% :       0(  0%)
   81- 90% :       0(  0%)
   91-100% :      0(  0%)

```

Total

0

4872 hh:mm:ss unt1 __pd0dbst KFPK10300-I Pddbst started

4872 hh:mm:ss unt1 __pd0dbst KFPK10301-I Pddbst terminated, return code=0

pddbst 08-05(Object Option) ** RD Area Logical Analysis ** YYYY/MM/DD hh:m

m:ss

RD Area Name : AJS2INDX

Server : ajs2

Total Segment : 904 Segment Size : 10 Pages

Unused Segment: 885 Page Size : 4096 Bytes

History1 Hold Status : Hold Code : 0 Hold Time :

History2 Hold Status : Hold Code : 0 Hold Time :

Index Name : AJS1ARROWINDEX1

Auth Id : root

Status :

| | Used(Full) | Used(| Full) | Sum |
|---------|------------|-------|-------|-----|
| Segment | 100%(0%) | 1(| 0) | 1 |
| Page | 10%(0%) | 1(| 0) | 10 |

Collect On Segment : 0

Collect Prearranged Page : 1

Collect On Page : 0

Used Page Ratio Page(Ratio)

```

    0% :          10( 100%)
    1- 10% :       0(  0%)
   11- 20% :       0(  0%)

```



```

21- 30% :          0 ( 0%)
31- 40% :          0 ( 0%)
41- 50% :          0 ( 0%)
51- 60% :          0 ( 0%)
61- 70% :          0 ( 0%)
71- 80% :          0 ( 0%)
81- 90% :          0 ( 0%)
91-100% :          0 ( 0%)
Total                10

```

Index Name : AJS1BODYINDEX1

Auth Id : root

Status :

```

      Used(Full)      Used(      Full)      Sum
Segment 100%( 0%)      1(          0)      1
Page    10%( 0%)      1(          0)      10
Collect On Segment :          0
Collect Prearranged Page :          1
Collect On Page :          0
Used Page Ratio      Page(Ratio)
  0% :          10( 100%)
  1- 10% :          0( 0%)
 11- 20% :          0( 0%)
 21- 30% :          0( 0%)
 31- 40% :          0( 0%)
 41- 50% :          0( 0%)
 51- 60% :          0( 0%)
 61- 70% :          0( 0%)
 71- 80% :          0( 0%)
 81- 90% :          0( 0%)
 91-100% :          0( 0%)
Total                10

```

Index Name : AJS1CALINDEX1

Auth Id : root

Status :

```

      Used(Full)      Used(      Full)      Sum
Segment 100%( 0%)      1(          0)      1
Page    10%( 0%)      1(          0)      10
Collect On Segment :          0
Collect Prearranged Page :          1
Collect On Page :          0
Used Page Ratio      Page(Ratio)
  0% :          10( 100%)
  1- 10% :          0( 0%)
 11- 20% :          0( 0%)
 21- 30% :          0( 0%)
 31- 40% :          0( 0%)
 41- 50% :          0( 0%)
 51- 60% :          0( 0%)
 61- 70% :          0( 0%)
 71- 80% :          0( 0%)
 81- 90% :          0( 0%)
 91-100% :          0( 0%)
Total                10

```

Index Name : AJS1ENTRYINDEX1

Auth Id : root

```

Status      :
      Used(Full)      Used(      Full)      Sum
Segment 100%( 0%)      1(      0)      1
Page    10%( 0%)      1(      0)      10
Collect On Segment :      0
Collect Prearranged Page :      1
Collect On Page :      0
Used Page Ratio      Page(Ratio)
  0% :      10( 100%)
  1- 10% :      0(  0%)
 11- 20% :      0(  0%)
 21- 30% :      0(  0%)
 31- 40% :      0(  0%)
 41- 50% :      0(  0%)
 51- 60% :      0(  0%)
 61- 70% :      0(  0%)
 71- 80% :      0(  0%)
 81- 90% :      0(  0%)
 91-100% :      0(  0%)
Total      10

```

Index Name : AJS1GENINDEX1

Auth Id : root

```

Status      :
      Used(Full)      Used(      Full)      Sum
Segment 100%( 0%)      1(      0)      1
Page    10%( 0%)      1(      0)      10
Collect On Segment :      0
Collect Prearranged Page :      1
Collect On Page :      0
Used Page Ratio      Page(Ratio)
  0% :      10( 100%)
  1- 10% :      0(  0%)
 11- 20% :      0(  0%)
 21- 30% :      0(  0%)
 31- 40% :      0(  0%)
 41- 50% :      0(  0%)
 51- 60% :      0(  0%)
 61- 70% :      0(  0%)
 71- 80% :      0(  0%)
 81- 90% :      0(  0%)
 91-100% :      0(  0%)
Total      10

```

Index Name : AJS1IDINDEX1

Auth Id : root

```

Status      :
      Used(Full)      Used(      Full)      Sum
Segment 100%( 0%)      1(      0)      1
Page    10%( 0%)      1(      0)      10
Collect On Segment :      0
Collect Prearranged Page :      0
Collect On Page :      0
Used Page Ratio      Page(Ratio)
  0% :      9(  90%)
  1- 10% :      1(  10%)
 11- 20% :      0(  0%)
 21- 30% :      0(  0%)

```

```

31- 40% :          0 ( 0%)
41- 50% :          0 ( 0%)
51- 60% :          0 ( 0%)
61- 70% :          0 ( 0%)
71- 80% :          0 ( 0%)
81- 90% :          0 ( 0%)
91-100% :          0 ( 0%)

```

```
Total          10
```

Index Name : AJS1PERFINDEX1

Auth Id : root

Status :

| | Used(Full) | Used(| Full) | Sum |
|----------------------------|-------------|-------|-------|-----|
| Segment | 100%(0%) | 1 (| 0) | 1 |
| Page | 10%(0%) | 1 (| 0) | 10 |
| Collect On Segment : | | 0 | | |
| Collect Prearranged Page : | | | 1 | |
| Collect On Page : | | 0 | | |
| Used Page Ratio | Page(Ratio) | | | |
| 0% : | 10 (| 100%) | | |
| 1- 10% : | 0 (| 0%) | | |
| 11- 20% : | 0 (| 0%) | | |
| 21- 30% : | 0 (| 0%) | | |
| 31- 40% : | 0 (| 0%) | | |
| 41- 50% : | 0 (| 0%) | | |
| 51- 60% : | 0 (| 0%) | | |
| 61- 70% : | 0 (| 0%) | | |
| 71- 80% : | 0 (| 0%) | | |
| 81- 90% : | 0 (| 0%) | | |
| 91-100% : | 0 (| 0%) | | |
| Total | | | | 10 |

Index Name : AJS1PERFINDEX2

Auth Id : root

Status :

| | Used(Full) | Used(| Full) | Sum |
|----------------------------|-------------|-------|-------|-----|
| Segment | 100%(0%) | 1 (| 0) | 1 |
| Page | 10%(0%) | 1 (| 0) | 10 |
| Collect On Segment : | | 0 | | |
| Collect Prearranged Page : | | | 1 | |
| Collect On Page : | | 0 | | |
| Used Page Ratio | Page(Ratio) | | | |
| 0% : | 10 (| 100%) | | |
| 1- 10% : | 0 (| 0%) | | |
| 11- 20% : | 0 (| 0%) | | |
| 21- 30% : | 0 (| 0%) | | |
| 31- 40% : | 0 (| 0%) | | |
| 41- 50% : | 0 (| 0%) | | |
| 51- 60% : | 0 (| 0%) | | |
| 61- 70% : | 0 (| 0%) | | |
| 71- 80% : | 0 (| 0%) | | |
| 81- 90% : | 0 (| 0%) | | |
| 91-100% : | 0 (| 0%) | | |
| Total | | | | 10 |

Index Name : AJS1RELSINDEX1

Auth Id : root

Status :

| | Used(Full) | Used(| Full) | Sum |
|----------------------------|------------|-------------|-------|-----|
| Segment | 100%(0%) | 1(| 0) | 1 |
| Page | 10%(0%) | 1(| 0) | 10 |
| Collect On Segment : | | 0 | | |
| Collect Prearranged Page : | | | 1 | |
| Collect On Page : | | 0 | | |
| Used Page Ratio | | Page(Ratio) | | |
| 0% : | | 10(100%) | | |
| 1- 10% : | | 0(0%) | | |
| 11- 20% : | | 0(0%) | | |
| 21- 30% : | | 0(0%) | | |
| 31- 40% : | | 0(0%) | | |
| 41- 50% : | | 0(0%) | | |
| 51- 60% : | | 0(0%) | | |
| 61- 70% : | | 0(0%) | | |
| 71- 80% : | | 0(0%) | | |
| 81- 90% : | | 0(0%) | | |
| 91-100% : | | 0(0%) | | |
| Total | | 10 | | |

Index Name : AJS1RELSINDEX2

Auth Id : root

Status :

| | Used(Full) | Used(| Full) | Sum |
|----------------------------|------------|-------------|-------|-----|
| Segment | 100%(0%) | 1(| 0) | 1 |
| Page | 10%(0%) | 1(| 0) | 10 |
| Collect On Segment : | | 0 | | |
| Collect Prearranged Page : | | | 1 | |
| Collect On Page : | | 0 | | |
| Used Page Ratio | | Page(Ratio) | | |
| 0% : | | 10(100%) | | |
| 1- 10% : | | 0(0%) | | |
| 11- 20% : | | 0(0%) | | |
| 21- 30% : | | 0(0%) | | |
| 31- 40% : | | 0(0%) | | |
| 41- 50% : | | 0(0%) | | |
| 51- 60% : | | 0(0%) | | |
| 61- 70% : | | 0(0%) | | |
| 71- 80% : | | 0(0%) | | |
| 81- 90% : | | 0(0%) | | |
| 91-100% : | | 0(0%) | | |
| Total | | 10 | | |

Index Name : AJS1RELSINDEX3

Auth Id : root

Status :

| | Used(Full) | Used(| Full) | Sum |
|----------------------------|------------|-------------|-------|-----|
| Segment | 100%(0%) | 1(| 0) | 1 |
| Page | 10%(0%) | 1(| 0) | 10 |
| Collect On Segment : | | 0 | | |
| Collect Prearranged Page : | | | 1 | |
| Collect On Page : | | 0 | | |
| Used Page Ratio | | Page(Ratio) | | |
| 0% : | | 10(100%) | | |
| 1- 10% : | | 0(0%) | | |
| 11- 20% : | | 0(0%) | | |
| 21- 30% : | | 0(0%) | | |
| 31- 40% : | | 0(0%) | | |

```

41- 50% :          0 ( 0%)
51- 60% :          0 ( 0%)
61- 70% :          0 ( 0%)
71- 80% :          0 ( 0%)
81- 90% :          0 ( 0%)
91-100% :          0 ( 0%)
Total                10

```

Index Name : AJS1SCHINDEX1

Auth Id : root

Status :

```

      Used(Full)      Used(      Full)      Sum
Segment 100%( 0%)      1(          0)      1
Page    10%( 0%)      1(          0)      10
Collect On Segment :          0
Collect Prearranged Page :          1
Collect On Page :          0
Used Page Ratio      Page(Ratio)
  0% :          10 ( 100%)
  1- 10% :          0 ( 0%)
 11- 20% :          0 ( 0%)
 21- 30% :          0 ( 0%)
 31- 40% :          0 ( 0%)
 41- 50% :          0 ( 0%)
 51- 60% :          0 ( 0%)
 61- 70% :          0 ( 0%)
 71- 80% :          0 ( 0%)
 81- 90% :          0 ( 0%)
 91-100% :          0 ( 0%)
Total                10

```

Index Name : AJS1STATINDEX1

Auth Id : root

Status :

```

      Used(Full)      Used(      Full)      Sum
Segment 100%( 0%)      1(          0)      1
Page    10%( 0%)      1(          0)      10
Collect On Segment :          0
Collect Prearranged Page :          1
Collect On Page :          0
Used Page Ratio      Page(Ratio)
  0% :          10 ( 100%)
  1- 10% :          0 ( 0%)
 11- 20% :          0 ( 0%)
 21- 30% :          0 ( 0%)
 31- 40% :          0 ( 0%)
 41- 50% :          0 ( 0%)
 51- 60% :          0 ( 0%)
 61- 70% :          0 ( 0%)
 71- 80% :          0 ( 0%)
 81- 90% :          0 ( 0%)
 91-100% :          0 ( 0%)
Total                10

```

Index Name : AJS1UNITINDEX1

Auth Id : root

Status :

```

      Used(Full)      Used(      Full)      Sum

```

```

Segment 100%( 0%)          1(          0)          1
Page    10%( 0%)          1(          0)          10
Collect On Segment :          0
Collect Prearranged Page :          0
Collect On Page :          0
Used Page Ratio          Page(Ratio)
    0% :          9( 90%)
    1- 10% :          1( 10%)
    11- 20% :          0( 0%)
    21- 30% :          0( 0%)
    31- 40% :          0( 0%)
    41- 50% :          0( 0%)
    51- 60% :          0( 0%)
    61- 70% :          0( 0%)
    71- 80% :          0( 0%)
    81- 90% :          0( 0%)
    91-100% :          0( 0%)
Total                                10

```

```

Index Name : AJS1UNITINDEX2
Auth Id    : root
Status     :

```

```

          Used(Full)          Used(          Full)          Sum
Segment 100%( 0%)          1(          0)          1
Page    10%( 0%)          1(          0)          10
Collect On Segment :          0
Collect Prearranged Page :          0
Collect On Page :          0
Used Page Ratio          Page(Ratio)
    0% :          9( 90%)
    1- 10% :          1( 10%)
    11- 20% :          0( 0%)
    21- 30% :          0( 0%)
    31- 40% :          0( 0%)
    41- 50% :          0( 0%)
    51- 60% :          0( 0%)
    61- 70% :          0( 0%)
    71- 80% :          0( 0%)
    81- 90% :          0( 0%)
    91-100% :          0( 0%)
Total                                10

```

```

Index Name : AJSAGTEXECCNTINDEX1
Auth Id    : root
Status     :

```

```

          Used(Full)          Used(          Full)          Sum
Segment 100%( 0%)          1(          0)          1
Page    10%( 0%)          1(          0)          10
Collect On Segment :          0
Collect Prearranged Page :          0
Collect On Page :          0
Used Page Ratio          Page(Ratio)
    0% :          9( 90%)
    1- 10% :          0( 0%)
    11- 20% :          0( 0%)
    21- 30% :          1( 10%)
    31- 40% :          0( 0%)
    41- 50% :          0( 0%)

```

```

51- 60% :          0 ( 0%)
61- 70% :          0 ( 0%)
71- 80% :          0 ( 0%)
81- 90% :          0 ( 0%)
91-100% :          0 ( 0%)
Total                10

```

Index Name : AJSEXCAGTGRPINDEX1

Auth Id : root

Status :

```

      Used(Full)      Used(      Full)      Sum
Segment 100%( 0%)      1(          0)      1
Page    10%( 0%)      1(          0)      10
Collect On Segment :          0
Collect Prearranged Page :          1
Collect On Page :          0
Used Page Ratio      Page(Ratio)
  0% :          10( 100%)
  1- 10% :          0( 0%)
 11- 20% :          0( 0%)
 21- 30% :          0( 0%)
 31- 40% :          0( 0%)
 41- 50% :          0( 0%)
 51- 60% :          0( 0%)
 61- 70% :          0( 0%)
 71- 80% :          0( 0%)
 81- 90% :          0( 0%)
 91-100% :          0( 0%)
Total                10

```

Index Name : AJSEXCAGTINDEX1

Auth Id : root

Status :

```

      Used(Full)      Used(      Full)      Sum
Segment 100%( 0%)      1(          0)      1
Page    10%( 0%)      1(          0)      10
Collect On Segment :          0
Collect Prearranged Page :          0
Collect On Page :          0
Used Page Ratio      Page(Ratio)
  0% :          9( 90%)
  1- 10% :          1( 10%)
 11- 20% :          0( 0%)
 21- 30% :          0( 0%)
 31- 40% :          0( 0%)
 41- 50% :          0( 0%)
 51- 60% :          0( 0%)
 61- 70% :          0( 0%)
 71- 80% :          0( 0%)
 81- 90% :          0( 0%)
 91-100% :          0( 0%)
Total                10

```

Index Name : AJSLINKAGTINDEX1

Auth Id : root

Status :

```

      Used(Full)      Used(      Full)      Sum
Segment 100%( 0%)      1(          0)      1

```

```

Page      10%( 0%)          1(          0)          10
Collect On Segment :          0
Collect Prearranged Page :          1
Collect On Page :          0
Used Page Ratio          Page(Ratio)
  0% :          10( 100%)
  1- 10% :          0(  0%)
 11- 20% :          0(  0%)
 21- 30% :          0(  0%)
 31- 40% :          0(  0%)
 41- 50% :          0(  0%)
 51- 60% :          0(  0%)
 61- 70% :          0(  0%)
 71- 80% :          0(  0%)
 81- 90% :          0(  0%)
 91-100% :          0(  0%)
Total                                10

```

```

3729 hh:mm:ss until _pd0dbst KFPK10300-I Pddbst started
3729 hh:mm:ss until _pd0dbst KFPK10301-I Pddbst terminated, return code=0
pddbst 08-05(Object Option) ** RD Area Logical Analysis ** YYYY/MM/DD hh:m
m:ss

```

```

RD Area Name      : AJS2INDX2
Server            : ajs2
Total Segment    :      3000      Segment Size :          10 Pages
Unused Segment   :      2998      Page Size    :          4096 Bytes
History1 Hold Status :          Hold Code :      0 Hold Time :
History2 Hold Status :          Hold Code :      0 Hold Time :

```

```

-----
Index Name : AJS1JINFINDEX1
Auth Id    : root
Status     :
  Used(Full)      Used(      Full)      Sum
Segment 100%( 0%)          1(          0)          1
Page     10%( 0%)          1(          0)          10
Collect On Segment :          0
Collect Prearranged Page :          1
Collect On Page :          0
Used Page Ratio          Page(Ratio)
  0% :          10( 100%)
  1- 10% :          0(  0%)
 11- 20% :          0(  0%)
 21- 30% :          0(  0%)
 31- 40% :          0(  0%)
 41- 50% :          0(  0%)
 51- 60% :          0(  0%)
 61- 70% :          0(  0%)
 71- 80% :          0(  0%)
 81- 90% :          0(  0%)
 91-100% :          0(  0%)
Total                                10

```

```

Index Name : AJS1JINFINDEX2
Auth Id    : root
Status     :
  Used(Full)      Used(      Full)      Sum
Segment 100%( 0%)          1(          0)          1
Page     10%( 0%)          1(          0)          10

```



```

Collect On Segment :          0
Collect Prearranged Page :    1
Collect On Page :           0
Used Page Ratio      Page(Ratio)
   0% :                10 ( 100%)
   1- 10% :            0 (   0%)
  11- 20% :            0 (   0%)
  21- 30% :            0 (   0%)
  31- 40% :            0 (   0%)
  41- 50% :            0 (   0%)
  51- 60% :            0 (   0%)
  61- 70% :            0 (   0%)
  71- 80% :            0 (   0%)
  81- 90% :            0 (   0%)
  91-100% :           0 (   0%)
Total                  10

```

Collect Prearranged Page

Indicates the size in pages of the area that can be released by using the `ajsembdbreclaim` command.

Check this value to determine when to execute the `ajsembdbreclaim` command.

If this value is 0, no area is released even if you execute the `ajsembdbreclaim` command. We recommend that you execute the `ajsembdbreclaim` command when this value reaches 30 to 50% of the pages being used. However, this command is not very effective if the number of pages being used is 50 pages or less. If the number of pages being used exceeds 10,000, we recommend that you execute the `ajsembdbreclaim` command when this value reaches 20 to 30% of the pages being used.

Collect On Page

The output value is the number of pages in the state in which release processing is incomplete because the `ajsembdbreclaim` command is being executed or because the `ajsembdbreclaim` command did not end normally.

Used Page Ratio, Page(Ratio)

Indicates the detailed information about the pages allocated to the table or the index.

When more pages are at higher percentages, storage efficiency is better. When only a few pages are at higher percentages, storage efficiency is worse.

Because the percentages in parentheses are rounded up at the decimal point, the total might add up to more than 100%.

Checking the system log of the embedded database

```

ajsembdbstatus -l -id _JF0

HOSTNAME : 127.0.0.1(201942)
Group    Type Server  Gen No. Status   Run ID   Block No. Ex-Status
log1     sys  ajs2      1 oc-d--u 433a0c53  1      ae  -x-----
log2     sys  ajs2      0 os----- 00000000  0      0  -u-----
log3     sys  ajs2      0 os----- 00000000  0      0  -u-----
log4     sys  ajs2      0 os----- 00000000  0      0  -u-----
log5     sys  ajs2      0 os----- 00000000  0      0  -u-----
log6     sys  ajs2      0 os----- 00000000  0      0  -u-----
log7     sys  ajs2      0 os----- 00000000  0      0  -u-----
log8     sys  ajs2      0 os----- 00000000  0      0  -u-----
log9     sys  ajs2      0 os----- 00000000  0      0  -u-----
log10    sys  ajs2      0 os----- 00000000  0      0  -u-----
log11    sys  ajs2      0 os----- 00000000  0      0  -u-----
log12    sys  ajs2      0 os----- 00000000  0      0  -u-----

```

HOSTNAME

127.0.0.1 is displayed.

The item in parentheses is the hour, minutes, and seconds (format: *HHMMSS*) of the time when the `ajsembdbstatus` command is executed.

Cautionary note

If any of the conditions below is met, the host name of the embedded database installation directory is output by using no more than 32 characters. In a cluster configuration, the first host name that is set as the active server is output.

- When JP1/AJS3 - Manager for Windows version 09-50 or earlier is used and the embedded database has been built on a logical host
- When JP1/AJS3 - Manager for UNIX version 09-50 or earlier is used
- When JP1/AJS3 - Manager version 09-50 or earlier is updated to version 10-00 or later, and IPv6 has not been set up

Group

Indicates the name of the system log file group for the embedded database with up to eight characters.

Type

Always `sys`.

Server

Always `ajs2`.

Gen No.

Indicates the generation number of the system log with a hexadecimal number of eight digits or less. This number indicates the sequence of the system logs used by the embedded database and starts at 1. After the last system log file group has been used, the first system log file group is used again. At this time, the generation number of the system log is updated.

Status

Indicates the status of the system log file group with seven characters:

First character:

Open status of the system log file group

o: Open

c: Closed

This character is o when the embedded database is running. The character is c when the embedded database is not running.

Second character:

Current status of the system log file group

c: Active

s: Standby

n: Reserved

During operation, the system log file group currently used is indicated as c, and other system log file groups are indicated as s.

If no system log file can be accessed because, for example, the embedded database is not running or the disk that contains system log files is not mounted, n is output.

Third character:

Unload status of the system log file group

- u: The log file group is waiting to be unloaded.

(The log file group was active, but swapped and is not currently being used.)

No action is necessary if the operation does not use the system log (that is, the `ajsembddbbuild` command with neither the `-bs` nor `-br` option specified was executed during embedded database environment setup).

If the operation uses the system log (that is, the `ajsembddbbuild` command with the `-bs` or `-br` option specified was executed during embedded database environment setup), the system log file group must be unloaded. However, normally, this unloading is automatically performed.

- -: The log file group is unloaded.

Fourth character:

Indicates whether the system log file group can be overwritten.

- d: The log file group cannot be overwritten (the system log file group contains a log required for restoring the embedded database).

If all the system log files on the server are in this status, the embedded database stops. In that case, add a system log file.

This status might occur when an extremely large job is defined in a batch job and the resulting embedded database transaction is extremely long.

- -: The log file group can be overwritten (the system log file group does not contain a log required for restoring the embedded database).

Fifth character:

Internal information used by the system.

Sixth character:

The usage history of the system log file group

- c: The system log file group that is currently active
Displayed only when the embedded database has stopped.

Seventh character:

Internal information used by the system.

Run ID

Indicates information used by the system.

Block No.

Indicates the first block number and the last block number in the system log file with hexadecimal numbers of eight digits or less.

Ex-Status

Indicates the expansion status of the system log file group with eight characters.

First character:

Internal information used by the system.

Second character:

The automatic expansion status of the system log file group.

u: The system log file group is subject to the system log file auto-increment function.

e: System log files are expanded.

x: The system log file group is not subject to the system log file auto-increment function.

-: The system log file auto-increment function is not used.

Third character:

Whether automatic expansion of the system log file group is possible.

-: Possible by using the system log file auto-increment function.

x: Not possible by using the system log file auto-increment function.

Fourth, Fifth, sixth, seventh, and eighth characters:

Indicates information used by the system.

Checking the embedded database configuration information

```
ajsembdbstatus -c -id _JF1

HOSTNAME=lhost1
INSTALLDIR= "C:\Program Files\HITACHI\JP1AJS2\embdb\_JF1"
SETUPID=_JF1
RAWFILE= "ajssys01=\\.\D:,ajssys11=\\.\E:"
DATADIR=
WORKDIR=" C:\Program Files\HITACHI\JP1AJS2\embdb\_JF1\dbarea"
EMBDBPORT=22221
DBMODEL=1
PHYSICALHOST=phost
SYSLOGCNF=single
UNLDDIR="C:\Program Files\HITACHI\JP1AJS2\embdb\_JF1\unload"
EXTENDDB=no
EXTENDLOG=no
ENHANCEDBACKUP=yes
```

HOSTNAME

The name of the host that was set when the embedded database was built is output.

INSTALLDIR

The installation directory of the embedded database is output.

SETUPID

The embedded database setup identifier is output.

RAWFILE

The data area partition is output when a RAW file is used for the data area and the system area of the embedded database. This information is output for compatibility.

DATADIR

The data area directory of the embedded database is output. When system logging is being used, the system area directory is also output.

WORKDIR

The work area directory is displayed.

EMBDBPORT

The port number of the embedded database is displayed.

DBMODEL

The database model is output:

l: Large scale

m: Medium scale

s: Small scale

PHYSICALHOST

If a cluster configuration environment is used, the name of the primary node physical host is output.

SYSLOGCNF

The system logging setting is displayed:

single: The system file is not duplicated.

dual: The system file is duplicated.

none: System logging is disabled.

UNLDDIR

The directory where the unload log file has been created is output.

This information is not displayed if system logging is not used.

EXTENDDB

The setting of the database area auto-increment function is output:

yes: The function is enabled.

no: The function is disabled.

EXTENDLOG

The setting of the system log auto-increment function is output:

yes: The function is enabled.

no: The function is disabled.

ENHANCEDBACKUP

The setting of the backup enhancement function is output. This item is not displayed if the JP1/AJS3 version when the embedded database is configured is earlier than 12-10.

yes: The function is enabled.

no: The function is disabled.

ajsembdbstop

Format

```
ajsembdbstop
  [-f [-q]]
  [-id embedded-database-setup-ID]
```

Format 1 (for normally stopping the embedded database)

```
ajsembdbstop
  [-id embedded-database-setup-ID]
```

Format 2 (for forcibly stopping the embedded database)

```
ajsembdbstop
  -f
  [-q]
  [-id embedded-database-setup-ID]
```

Description

Stops the embedded database.

You can execute this command only while the embedded database and all the scheduler services for which the applicable embedded database was created as the scheduler database are not running.

Execution privileges

In Windows: Administrators privileges

In UNIX: Superuser privileges

Storage directory

In Windows:

```
JP1/AJS3 - Manager-installation-folder\tools\
```

In UNIX:

```
/opt/jplajs2/tools/
```

Arguments

-f

Specify this option to forcibly stop the embedded database.

When you specify this option in the command you execute, the embedded database is forcibly stopped whether or not the embedded database is being accessed. It might take some time for the embedded database to start the next time you attempt starting it.

-q

Use this option when a cluster environment is created.

Use this option to stop the embedded database when failover.

-id *embedded-database-setup-ID*

Specify the setup identifier that identifies the embedded database in the `_JFn` format (*n*: 0-9 or A-Z). The value specified in this argument must be the same as the value specified in the `-id` option of the `ajsembdbbuild` command.

If you want to operate an embedded database created by using the `jajs_setup`, `jajs_setup_cluster`, and `jajs_migrate` commands, use the `ajsembdbidlist` command to check the setup identifier of the embedded database. For details on the `ajsembdbidlist` command, see [ajsembdbidlist](#) in *2. Commands Used during Setup*.

If you omit this option, the system assumes `_JF0`.

Notes

- Before you stop the embedded database normally, stop all scheduler services that use the embedded database as the scheduler database. In addition, stop the JP1/AJS3 service and other services that access the embedded database. If you attempt to stop the embedded database normally without stopping these services, the embedded database might be unable to stop, causing you to wait for a long time.
- If you forcibly stop the embedded database while the embedded database is being accessed, jobs being executed are forcibly terminated or access from JP1/AJS3 - View is forcibly disconnected.
- This command is implemented by a script. If you specify an excessively long character string or an invalid character string or value for an option, an unexpected error might occur. You must use the number of characters allowed for a character string or a value in the option as specified in the DBMS and JP1/AJS3 specifications.
- You cannot execute this command together with any of the following commands on the same logical host:
 - `ajspofalter` command
 - `ajsembdbstart` command
 - `ajsembdbstop` command
 - `ajsstart` command
 - `ajsstop` command
 - `jajs_hstd` command
 - `jajs_hstd_stop` command
 - `jajs_spmd` command
 - `jajs_spmd_status` command
 - `jajs_spmd_stop` command
 - `jajs_start` command (UNIX only)
 - `jajs_start.cluster` command (UNIX only)
 - `jajs_stop` command (UNIX only)
 - `jajs_stop.cluster` command (UNIX only)
- When JP1/AJS3 is running, the `jajs_dbmd` process also stops. Note, however, that if the type of the embedded database is one used for JP1/AJS3 - Manager before version 10-00, the `jajs_dbmd` process does not stop.
- Do not execute this command more than once in quick succession. If you do so, the following problems might occur:
 - The message output is invalid. For example, an invalid message is output or a message that should be output is not output.
 - The command results in an error.

Return values

| | |
|--------------|---|
| 0 | Normal end |
| 1 | The embedded database is being started or stopped |
| 2 | The embedded database is being stopped |
| Other values | Abnormal end |

Actions to be taken if an error occurs

If a command error occurs, take the indicated action in the following table.

| Message | Cause | Action to be taken |
|------------|--|--|
| KAVS0787-E | The system administration daemon is processing. | Use the <code>jaajs_spmc_status</code> command to check the service status, and then re-execute the command. |
| KAVS0996-E | The specified option contains an error. | Check the specification of the option. |
| KAVS2101-E | The embedded database is inactive. | The embedded database is already stopped and no action is required. |
| KAVS2102-E | The embedded database is being started or stopped. | Use the <code>-s ust</code> option of the <code>ajsembdbstatus</code> command to check whether the embedded database is running and then re-execute the command. |
| KAVS2104-E | The embedded database is not set up. | Set up the embedded database and then re-execute the command. |
| KAVS2116-E | The specified option contains an error. | Check the option output in the message and then re-execute the command. |
| KAVS2117-E | An error occurred during execution of the command. | Check the message output in the maintenance information. |

ajsentry

Format

```
ajsentry
  [-F service-name]
  [{-s|-n|-f|-d[[year/]month/]day -t hours[:minutes] |
   -p schedule-information-file-name}] [-g number-of-scheduled-
   future-generations]
  [-o]
  [-w]
  [-c macro-variable-specification]
  [-R]
  [-L]
  [-T]
  [-m {hours:minutes|M-minutes|unlimited} -k {number-of-
   times|unlimited}]
  [-b [[year/]month/]day -e [[year/]month/]day]
  [-h]
  jobnet-name-or-job-group-name...
```

Description

Registers a defined jobnet for execution. The `ajsentry` command also checks whether the unit specified during registration for execution satisfies any of the following conditions, and if any are satisfied, an error is returned:

- A jobnet connector is created for a jobnet with start conditions.
- A jobnet with start conditions is specified as the connection-destination jobnet.
- A root jobnet that contains a job for which a jobnet connector is defined is specified as the connection-destination jobnet.
- Start conditions are set for a unit in the planning group specified as the connection-destination jobnet.
- A root remote jobnet is defined under the planning group specified as the connection-destination jobnet.
- A jobnet connector is defined under the planning group specified as the connection-destination jobnet.

Execution privileges

You must have any of the following JP1 privileges:

- JP1_AJS_Admin privilege
- JP1_AJS_Manager privilege
- JP1_AJS_Operator privilege

Arguments

-F *service-name*

Specify the name of the target scheduler service.

You can specify a character string of 1 to 30 bytes.

-s

Executes a jobnet according to the schedule defined for it (registers a jobnet for planned execution).

Unlike the `-f` option, this option causes the system to execute a jobnet which is scheduled to execute on the day even if you execute the command after the scheduled time for executing the jobnet has passed.

You cannot specify this option with the `-n`, `-f`, `-d`, `-t`, `-p`, `-g`, `-w`, `-m`, or `-k` option.

-n

Executes a jobnet immediately, ignoring any schedule defined for the jobnet (registers a jobnet for immediate execution). Note that the start conditions will be valid only when they are specified with the `-m` or `-k` option.

You cannot specify this option with the `-s`, `-f`, `-d`, `-t`, `-p`, `-g`, or `-o` option.

-f

Executes a jobnet according to the next schedule after the registration of execution (registers a jobnet for planned execution).

Unlike the `-s` option, this option does not cause the system to execute a jobnet which is scheduled to execute on the day if you execute the command after the scheduled time for executing the jobnet has passed.

You cannot specify this option with the `-s`, `-n`, `-d`, `-t`, `-p`, `-g`, `-w`, `-m`, or `-k` option.

-d [[year/] month/] day

Executes the jobnet at the specified date, irrespective of the schedule defined in the jobnet (the jobnet is determined, executed, and registered). Jobnets with start conditions are immediately executed without monitoring the start conditions.

Specify this option together with the `-t` option.

You cannot specify this option with the `-s`, `-n`, `-f`, `-p`, `-g`, `-w`, `-m`, or `-k` option.

- *year*

You can specify a value between 1994 and the value of the `SCHEDULELIMIT` environment setting parameter for the year. For details about the `SCHEDULELIMIT` environment setting parameter, see *20.4.2(123) SCHEDULELIMIT* in the *JP1/Automatic Job Management System 3 Configuration Guide*.

- *month*

You can specify a value between 1 (or 01) and 12.

- *day*

You can specify a value between 1 (or 01) and 31.

If you omit the specification of the year or both the year and month for this option, the system assumes the following values:

year: The *year* in which you executed the command

year/month: The year and month in which you executed the command

-t hours [:minutes]

Executes the jobnet at the specified time, irrespective of the schedule defined in the jobnet (the jobnet is determined, executed, and registered). Jobnets with start conditions are immediately executed without monitoring the start conditions.

Specify this option together with the `-d` option.

You cannot specify this option with the `-s`, `-n`, `-f`, `-p`, `-g`, `-w`, `-m`, or `-k` option.

- *hours*

You can specify a value between 0 (or 00) and 47 hours.

- *minutes*

You can specify a value between 0 (or 00) and 59 minutes. If you omit this option, the system assumes 0.

`-p` *schedule-information-file-name*

Specify the name of the schedule information file in which you have defined execution schedule for the jobnet (so that the jobnet is registered for fixed execution). you can use the `ajsschedule` command to create a schedule information file.

You can specify a character string of 1 to 255 bytes. The file name should use the full path name.

You cannot specify this option with the `-s`, `-n`, `-f`, `-d`, `-t`, `-w`, `-m`, or `-k` option.

When you specify the `-p` option, specify for the jobnet name only the root jobnet name that is specified when a schedule information file is created. This command ends abnormally when this option is specified together with the wildcard characters or the `-R` option, and the root jobnet name in the schedule information file does not match the specified root jobnet name.

`-g` *number-of-scheduled-future-generations*

Specify the number of subsequent generations you want to execute according to the fixed schedule.

You can specify a number between 1 and 99 (logs).

You cannot specify this option with the `-s`, `-n`, `-f`, `-d`, `-t`, `-w`, `-m`, or `-k` option.

`-o`

Does not execute a jobnet which is scheduled to execute on the day when you start the scheduler service, if its scheduled time for starting execution is prior to the time when you start the scheduler service.

You cannot specify this option with the `-w`, `-m`, `-k`, `-n`, or `-h` option. This option is valid if the service startup mode is set to a warm start or a disaster recovery start.

`-w`

Terminates the command upon the completion of executing the jobnet, if it is registered for immediate execution.

You can specify this option when registering the root jobnet for immediate execution.

Even if this option is specified, the command will terminate without waiting for the end of the jobnet in the following cases:

- The scheduler service stops during jobnet execution.
- The generation with a termination wait specified is left unexecuted using a carryover method.
- The generation with a termination wait specified is deleted. (For example, the generation that is unregistered for execution or registered for immediate execution or fixed execution discontinues its execution.)
- The generation with a termination wait specified is left unplanned.

You must specify this option with the `-n` option. You cannot specify this option with the `-m` or `-k` option.

-c *macro-variable-specification*

Specify the information that is to be set in the macro variable used by the jobs placed under the root jobnet. At the time of job execution, this is expanded into the passing information in the specified macro variable.

You can set up to 32 items in the form of `-c macro-variable-name : passing-information`. If you specify more than one of the same macro variable name, the passing information in only the first one is effective. For multiple items, you can specify a string of a maximum of 4,085 bytes (including the value of the macro variable name + the passing information + 4).

- *macro-variable-name*

Specify this name in AJS2xxxxx form, in which xxxxx is any character string. There is no need to prefix or suffix it with a question mark (?). You can use upper-case alphabetic characters, numeric characters, and periods (.).

You can specify a string of up to 62 bytes, which is calculated by subtracting 2 (two question marks at both ends) from 64.

- *passing-information*

Specify any character string.

You can specify a string of 1 to 255 bytes.

-R

Registers all units contained in the specified job group for execution.

If you specify this option with the `-L` and/or `-T` options, the system registers the jobnets for execution according to the specification of each option.

If you do not specify the `-T` option together with the `-R` option, all the units are registered for execution, and the execution registration processing for the units except the root jobnet ends abnormally.

-L

Registers jobnets which have not been registered for execution.

-T

Registers root jobnets.

-m { *hours:minutes* | *M-minutes* | *unlimited* }

Specify the time the system will wait for the start condition to be satisfied.

You must specify this option with the `-n` and `-k` options. You cannot specify this option with the `-w` option.

- *hour:minutes*

Specify an absolute time.

You can specify a value between 0 (or 00) and 47 for the hour.

You can specify a value between 0 (or 00) and 59 for the minute.

- *M-minutes*

Specify a time relative to the scheduled start time for the jobnet.

You can specify a value between 1 (or 01) and 2,879 minutes.

- *unlimited*

Waits for an unlimited time of period until the condition is satisfied.

-k {*number-of-times*|unlimited}

Specify the number of times the system will wait for the start condition to be satisfied.

You must specify this option with the `-n` and `-m` options. You cannot specify this option with the `-w` option.

- *number-of-times*
You can specify a value between 1 and 999 (times).
- *unlimited*
Sets an unlimited number of times for waiting.

-b [[*year*/]*month*/*day*]

Specify the start date of the period for executing a jobnet according to the schedule defined for the jobnet (fixed execution registration of the jobnet performed). The specified start date complies with the base time.

- *year*
You can specify a value between 1994 and the value of the `SCHEDULELIMIT` environment setting parameter for the year. For details about the `SCHEDULELIMIT` environment setting parameter, see *20.4.2(123) SCHEDULELIMIT* in the *JP1/Automatic Job Management System 3 Configuration Guide*.
- *month*
You can specify a value between 1 (or 01) and 12.
- *day*
You can specify a value between 1 (or 01) and 31.

If you omit the specification of the year or both the year and month for this option, the system assumes the following values:

year: The *year* in which you executed the command

year/month: The year and month in which you executed the command

You must specify this option with the `-e` option.

You cannot specify this option with the `-s`, `-n`, `-f`, `-d`, `-t`, `-p`, `-w`, `-m`, or `-k` option.

-e [[*year*/]*month*/*day*]

Specify the end date of the period for executing a jobnet according to the schedule defined for the jobnet (fixed execution registration of the jobnet performed). The specified end date complies with the base time.

- *year*
You can specify a value between 1994 and the value of the `SCHEDULELIMIT` environment setting parameter for the year. For details about the `SCHEDULELIMIT` environment setting parameter, see *20.4.2(123) SCHEDULELIMIT* in the *JP1/Automatic Job Management System 3 Configuration Guide*.
- *month*
You can specify a value between 1 (or 01) and 12.
- *day*
You can specify a value between 1 (or 01) and 31.

If you omit the specification of the year or both the year and month for this option, the system assumes the following values:

year: The *year* in which you executed the command

year/month: The year and month in which you executed the command

You must specify this option with the `-b` option.

You cannot specify this option with the `-s`, `-n`, `-f`, `-d`, `-t`, `-p`, `-w`, `-m`, or `-k` option.

-h

Holds the execution of the root jobnet when the jobnet is registered for execution.

The hold attribute is set in the first execution generation of those generations created when the jobnet is registered for execution.

If you specify the schedule information file name in the `-p` option to register a jobnet for execution, the hold attribute is set in the first created generation. Therefore, you must note that if schedule information entries are not arranged in date order while the schedule information file is being edited, the hold attribute might be set for unintended generations.

jobnet-name or job-group-name

Specify the name of the jobnet you want to register for execution. You can also specify a jobnet name or job group name with the `-R`, `-L`, or `-T` option.

You can specify a character string of 1 to 930 bytes.

You can specify more than one jobnet name or job group name. If you want to specify a jobnet name, however, you can specify only a root jobnet name. You cannot specify a manager job group name or manager jobnet name.

You can specify a logical host as a jobnet or job group name. You cannot specify an execution ID.

Notes

- Either of the following users can register fixed execution of a jobnet:
 - A user granted the operation privilege when all the units in the jobnet to be registered for execution were defined or when their attributes were changed
 - A JP1 user mapped to the OS user who has Administrators or superuser privileges
Note, however, that if `yes` is set after changing the `ADMACLIMIT` environment setting parameter from its default, even a JP1 user who was mapped to an OS user who has Administrators or superuser privileges must have the operation privilege.
- This command terminates abnormally if the scheduler service is not running.
- To register a jobnet for execution, be sure to use the same procedure as for registering the next execution schedule of the jobnet. If the next schedule of a jobnet has already been registered for planned execution, you cannot register this jobnet for planned execution. In these cases, the command terminates abnormally.
- You cannot register a jobnet for planned execution if the jobnet is scheduled to run next. The command terminates abnormally.
- A jobnet registered for immediate execution is not scheduled to be executed again, so the jobnet can be re-registered for immediate execution even if the jobnet has already been registered for immediate execution.
- If a jobnet you are going to register for execution is suspended, the command terminates abnormally.
- You can execute up to 50 instances of the following two commands at the same time:
 - The `ajsentry` command with the `-w` option specified

- The `ajspan` command with the `-w` option specified

If there are 50 instances of the two commands already running, the next instance terminates abnormally.

- For the root jobnet under the planning group, only fixed execution registration specified by the `-p` option, or the `-b` and `-e` options can be performed. If you execute the command in any other way, it ends abnormally.
- If you specify the `-w` option to terminate the `ajsendry` command after the jobnet is executed, you cannot obtain the result of jobnet execution in the return value of the `ajsendry` command. You must separately execute the `ajsshows` command to obtain the result of jobnet execution.
- If you specify none of the `-n`, `-f`, `-d`, `-t`, `-p`, and `-g` options, the `-s` option is assumed.
- This note applies to root jobnets whose execution order is controlled by using jobnet connectors. Even though there are no jobnet generations for which a connection relation is established between a root jobnet for which a jobnet connector is defined and the connection-destination jobnet, the jobnet is registered for execution.
- If you register a release-target jobnet (a root jobnet registered for release) for immediate execution, the jobnet is executed immediately with the jobnet definition that was applied.

Return values

| | |
|--|--------------|
| 0 | Normal end |
| 1 to 3 or multiple of 4 within the range from 4 to 124 | Abnormal end |

Example1

The following command registers jobnet `net1` for planned execution (executes the jobnet according to the schedule defined for it).

```
ajsendry -s net1
```

Example2

In this example, the command sets a macro variable (`AJS2ENV`) and a value (`/tmp/unit_data`) in a jobnet (`net1`), and registers the jobnet for immediate execution.

```
ajsendry -n -c AJS2ENV:/tmp/unit_data net1
```

Example 3

In this example, the command registers jobnet `net1` for fixed execution.

- Registration for fixed execution at a specific time (20:00 on July 1, 2010)

```
ajsendry -d 2010/07/01 -t 20 /net1
```

- Registration for fixed execution in a specific time period (based on the execution schedule specified in the schedule information file)

```
ajsendry -p schedule-information-file-name /net1
```

ajsexport

Format

```
ajsexport
  -o package-file-name
  export-unit-name
```

Description

This command can be used for the packaging feature provided by JP1/AJS3. You can only use these commands in a batch file or shell script for the packaging function.

To back up ordinary units, use the `ajsprint` or `ajsbackup` command.

This command exports all units under several units into a single package file (you can import the package file using the `ajsimport` command).

If the `AJSPRINTNETSCHPRF` environment setting parameter specifies the dependency on the schedule for the upper-level jobnet, you can specify either of the following methods to output the unit definition information for the nested jobnet having a schedule rule:

- Enable the schedule rule and do not depend on the schedule for the upper-level jobnet.
- Delete the schedule rule and depend on the schedule for the upper-level jobnet.

For details about how to set the `AJSPRINTNETSCHPRF` environment setting parameter, see [20.4.2\(79\) AJSPRINTNETSCHPRF](#) in the *JP1/Automatic Job Management System 3 Configuration Guide*.

Execution privileges

You must have any of the following JP1 privileges:

- JP1_AJS_Admin privilege
- JP1_AJS_Manager privilege
- JP1_AJS_Editor privilege
- JP1_AJS_Operator privilege
- JP1_AJS_Guest privilege

Arguments

-o *package-file-name*

Specify the name of the file in which you want to package units.

You can specify a character string of 1 to 255 bytes.

export-unit-name

Specify the units you want to package, in the following format:

Format

```
scheduler-service-name:/unit-full-name
```

Specification method

You can specify a character string of 1 to 930 bytes.

You can specify wildcard characters only for the full last element name of the unit name.

Notes on specification

You cannot export the root job group (/).

Notes

- Either of the following users can export a unit:
 - A user granted the reference privilege for the unit to be exported
 - A JP1 user mapped to the OS user who has Administrators or superuser privileges
Note, however, that if `yes` is set after changing the `ADMACLIMIT` environment setting parameter from its default, even a JP1 user who was mapped to an OS user with Administrators or superuser privileges must have the reference privilege.
- If you export more than one unit definition having the same unit name, specify a separate package file for each unit definition.
- If the command is executed for a release target jobnet (root jobnet for which release entry is made), the jobnet definitions in *Being applied* status are exported. However, the exported unit definition information does not include release information.

Return values

| | |
|--|--------------|
| 0 | Normal end |
| Multiple of 4 within the range from 4 to 124 | Abnormal end |

ajsfxbcstatus

Format

```
ajsfxbcstatus
```

Description

The command outputs the following information.

- Whether the agent is set up as a destination agent at the broadcast destination. If the agent is set up in this way, the command outputs the IP address or host name of the broadcast agent specified during setup.
- Whether the agent is set up as a broadcast agent. If the agent is set up in this way, the command outputs a list of IP addresses and host names of managed destination agents. The output is produced in order of ascending IP addresses.

Execution privileges

None

Storage directory

In Windows:

```
JP1/AJS3 - Manager-installation-folder\bin\  
JP1/AJS3 - Agent-installation-folder\bin\  

```

In UNIX:

```
/opt/jplajs2/bin/
```

Arguments

None

Return values

| | |
|--------------|---|
| 0 | The agent is not set up as a broadcast agent or a destination agent at the broadcast destination. |
| 1 | The agent is set up as a destination agent at the broadcast destination. |
| 2 | The agent is not set up as a broadcast agent. |
| 3 | The agent is set up as both a broadcast agent and a destination agent at the broadcast destination. |
| 4 or greater | Abnormal end |

Output example

The following shows an output example when the agent is set up as both a broadcast agent and a destination agent at the broadcast destination.

```
----- Destination Agent -----  
Setup Status:yes  
Broadcast Agent:192.168.1.10  
  
----- Broadcast Agent -----  
Setup Status:yes
```

Destination Agent List:

| Registered Date | Last Update Date | Destination | HostName |
|---------------------|---------------------|--------------|----------|
| 2016/04/02 09:05:01 | 2016/04/03 08:04:50 | 192.168.1.1 | Agent01 |
| 2016/04/01 13:05:01 | 2016/04/03 08:04:51 | 192.168.1.2 | Agent02 |
| 2016/04/01 13:15:01 | 2016/04/03 08:04:51 | 192.168.1.3 | Agent03 |
| 2016/04/03 00:05:01 | 2016/04/03 08:04:52 | 2001:db8::1e | Agent04 |

Destination Agent

Indicates information for the destination agent at the broadcast destination.

Setup Status

Indicates whether the agent is set up as a destination agent at the broadcast destination. If the agent is set up in this way, `yes` is displayed. If the agent is not set up in this way, `no` is displayed.

Broadcast Agent

Indicates the IP address or host name of the broadcast agent specified during setup. This item is not displayed if the agent is not set up as a destination agent at the broadcast destination.

Broadcast Agent

Indicates information for the broadcast agent.

Setup Status

Indicates whether the agent is set up as a broadcast agent. If the agent is set up in this way, `yes` is displayed. If the agent is not set up in this way, `no` is displayed.

Destination Agent List

Indicates information about managed destination agents. This item is not displayed if the agent is not set up as a broadcast agent.

- Registered Date

Indicates, in `YYYY/MM/DD hh:mm:ss` format, the date and time when a managed destination agent was first registered.

- Last Update Date

Indicates, in `YYYY/MM/DD hh:mm:ss` format, the last date and time when a heartbeat from the managed destination agent was received.

- Destination

Indicates the IP address of a managed destination agent.

- HostName

Indicates the host name of a managed destination agent.

ajsgtroot

Format

```
ajsgtroot
  [-F service-name]
  [-e]
  [-b]
  [-h]
  [-T]
```

Description

Outputs information for the operating environment of scheduler services to the standard output file.

Execution privileges

None

Arguments

-F *service-name*

Specify the name of the target scheduler service.

You can specify a character string of 1 to 30 bytes.

By default, the system assumes the main service name.

-e

Outputs the name of the error information directory.

-b

Outputs the name of the backup directory.

-h

Outputs the name of the history information file currently used.

If the JP1/AJS3 service is not running, however, the system outputs the name of log information file 1.

-T

Outputs the name of the temporary file directory.

Return values

| | |
|--|--------------|
| 0 | Normal end |
| Multiple of 4 within the range from 4 to 124 | Abnormal end |

Example

The following command outputs the name of the error information directory.

```
ajsgtroot -e
```

Output example

```
/var/opt/jplajs2/jobinf
```

ajsimport

Format

```
ajsimport
  [-f]
  [-S]
  -i package-file-name
  [import-unit-name]
```

Description

This command can be used for the packaging feature provided by JP1/AJS3. You can only use these commands in a batch file or shell script for the packaging function.

To restore ordinary units, use the `ajsdefine` or `ajsrestore` command.

Imports a package file you created with the `ajsexport` command.

Execution privileges

You must have any of the following JP1 privileges:

- JP1_AJS_Admin privilege
- JP1_AJS_Manager privilege
- JP1_AJS_Editor privilege

Arguments

-f

Forcibly updates the unit if the import destination contains a unit having the same name as the one you import.

If you omit this option, importing a unit to a destination containing an element having the same name will result in an error. The system does not update information.

-S

This option makes it possible to specify the particular jobnet name as the import unit name, even for suspended jobnets that have been registered for execution. Even for suspended jobnets, however, you cannot update definitions in the following situations:

- While the definition of the root jobnet is being updated
- While the definitions of job groups containing the definition of the root jobnet are being updated
- While jobnets are being executed

-i *package-file-name*

Specify the name of the package file you want to import.

You can specify a character string of 1 to 255 bytes.

import-unit-name

Specify the units you want to import, in the following format:

Format

```
scheduler-service-name:/unit-full-name
```

Specification method

- You can specify an arbitrary name for the import unit.
By default, the name specified in *Export unit name* in the `ajsexport` command is used for the import process.
- You can specify a character string of 1 to 930 bytes.

Notes on specification

You cannot use wildcard characters here.

Notes

- Either of the following users can import a unit:
 - A user granted the update privilege for the unit at the import destination
 - A JP1 user mapped to the OS user who has Administrators or superuser privileges
Note, however, that if `yes` is set after changing the `ADMACLIMIT` environment setting parameter from its default, even a JP1 user who was mapped to an OS user with Administrators or superuser privileges must have the update privilege.
- When importing a jobnet registered for execution (other than remote jobnets), you must put the jobnet at the import destination into a suspended state before specifying the `-S` option in this command.
- This command terminates abnormally if the jobnet specified in the import unit name is undergoing a suspended-stage change.
- You cannot import a planning group into a jobnet.
- You cannot import any unit other than a jobnet or remote jobnet into a planning group.
- You cannot update information about a root jobnet registered for execution or information about any job group or planning group containing that root jobnet.

Return values

| | |
|--|--------------|
| 0 | Normal end |
| Multiple of 4 within the range from 4 to 124 | Abnormal end |

ajsintrpt

Format

```
ajsintrpt
  [-F service-name]
  [-B execution-registration-number]
  [-R]
  [-E]
  [-T]
  [-X {yes|no|auto}]
  jobnet-name-or-job-group-name...
```

Description

Stops the execution of a jobnet after the currently running job is completed.

Execution privileges

You must have any of the following JP1 privileges:

- JP1_AJS_Admin privilege
- JP1_AJS_Manager privilege
- JP1_AJS_Operator privilege

Arguments

-F *service-name*

Specify the name of the target scheduler service.

You can specify a character string of 1 to 30 bytes.

-B *execution-registration-number*

Specify the execution registration number of the jobnet for which you want to stop execution, in the *YYYYMMDDNNN* format. The meaning of *YYYYMMDDNNN* is as follows:

YYYY: Year of the scheduled date of execution

MM: Month of the scheduled date of execution

DD: Day of the scheduled date of execution

NNN: Execution registration sequence number for the scheduled date of execution

For details of the execution registration number, see *4.5.13 Methods of specifying generations when executing commands* in the manual *JP1/Automatic Job Management System 3 Overview*.

-R

Stops the execution of all jobnets contained in the specified job group and jobnet.

If you specify this option with the *-E* and/or *-T* options, the system stops the execution of jobnets according to the specification of each option.

-E

Stops the execution of registered jobnets.

-T

Stops the execution of the root jobnet.

-X {yes|no|auto}

Specify whether to automatically select the current unit for operation from the units listed in a planning group. The units in the job group are not, however, automatically selected regardless of the specified value. You cannot omit a root jobnet name.

- `yes`

Specify this to automatically select a target unit.

When specifying a unit name in the command, omit a root jobnet name in a planning group.

- `no`

Specify this if you do not want to automatically select a target unit.

You must specify a unit for which the command will operate. You cannot omit a root jobnet name in a planning group.

- `auto`

Whether a target unit will automatically be selected depends on how the unit name is specified.

- If you want to automatically select a target unit

Specify a unit name without a root jobnet name in a planning group.

- If you do not want to automatically select a target unit

Specify a unit name with a root jobnet name in a planning group. The command will operate for the specified unit only. However, if there is a unit having the same name as the path name specified without a root jobnet name in a planning group, a root jobnet name is assumed to be omitted so that a target unit will be selected automatically.

jobnet-name-or-job-group-name

Specify the name of the jobnet for which you want to stop execution. You can also specify a jobnet name or job group name with the `-R`, `-E`, or `-T` option.

You can specify a character string of 1 to 930 bytes.

You can specify more than one jobnet name or job group name. If you want to specify a jobnet name, however, you can specify only a root jobnet name. You cannot specify a manager job group name or manager jobnet name.

You can specify a logical host name or execution ID as a jobnet or job group name. If you specify an execution ID, however, the `-B` option is disabled. For details about how to specify the execution ID, see [1.1 Command syntax](#).

Notes

- Either of the following users can interrupt execution of a jobnet:
 - A user granted the operation privilege when the units contained in the jobnet to be interrupted were defined or when their attributes were changed
 - A JP1 user mapped to the OS user who has Administrators or superuser privileges
Note, however, that if `yes` is set after changing the `ADMACLIMIT` environment setting parameter from its default, even a JP1 user who was mapped to an OS user who has Administrators or superuser privileges must have the operation privilege.
- This command terminates abnormally if you execute it when a scheduler service is not running.

- This command terminates abnormally if the target jobnet is being suspended.
- When you specify that a target unit automatically be selected from the units in a planning group, an error occurs if you do not have the appropriate operation privilege for the automatically selected unit.
- When the `-X` option is omitted, a target unit in a planning group is determined according to the value specified for the `AJSAUTOJUDGE` environment variable.
- For an explanation of how to specify the name of a unit in a planning group, see *Additional information in [ajsplan](#) in 3. Commands Used for Normal Operations.*
- If this command is executed, communication and database updating take place in JP1/AJS3. Therefore, if this command is executed many times in a short period, the overall JP1/AJS3 system will become heavily loaded and operations might be affected. For example, processing might be delayed. If you need to repeat execution of the command, pause for a few seconds between each execution. In particular, you must be careful when you execute the command for event jobs, custom event jobs or for a jobnet that uses event jobs or custom event jobs, because of the limit values for event jobs and custom event jobs. For details about the limit values for event jobs and custom event jobs, see *B.8 Limits for the event/action control in the JP1/Automatic Job Management System 3 System Design (Configuration) Guide.*

Return values

| | |
|--|--------------|
| 0 | Normal end |
| Multiple of 4 within the range from 4 to 124 | Abnormal end |

Additional information

- If you stop the generation in the Now monitoring status, that generation enters the Monitor terminated status. The generation in the Now running status or the generation in the Wait for start cond status waiting for the end of the generation in the Now running status is not stopped.
- You can use the `ajsrerun` command to re-execute a stopped jobnet.
- This command ends when a request is made to the scheduler service to interrupt the specified unit. The command does not wait for the specified unit to finish.

Example

The following command stops the execution of jobnet `net1`:

```
ajsintrpt net1
```

ajskill

Format

```
ajskill
  [-F service-name]
  [-B execution-registration-number]
  [-R]
  [-E]
  [{-T|-J}]
  [-X {yes|no|auto}]
  job-name-or-jobnet-name-or-job-group-name...
```

Description

Kills the execution of a job or jobnet.

If you kill a jobnet, the system aborts all jobs contained in that jobnet (including any nested jobnets). No other jobs in the jobnet will be newly created.

Execution privileges

You must have any of the following JP1 privileges:

- JP1_AJS_Admin privilege
- JP1_AJS_Manager privilege
- JP1_AJS_Operator privilege

Arguments

-F *service-name*

Specify the name of the target scheduler service.

You can specify a character string of 1 to 30 bytes.

-B *execution-registration-number*

Specify the execution registration number of the job or jobnet you want to kill, in the *YYYYMMDDNNN* format. The meaning of *YYYYMMDDNNN* is as follows:

YYYY: Year of the date of execution

MM: Month of the date of execution

DD: Day of the date of execution

NNN: Execution registration sequence number for the date of execution

For details of the execution registration number, see *4.5.13 Methods of specifying generations when executing commands* in the manual *JP1/Automatic Job Management System 3 Overview*.

-R

Kills all jobs and jobnets contained in the specified unit.

If you specify this option with the `-E`, `-T`, and/or `-J` options, the system kills the jobs or jobnets according to the specification of each option.

-E

Kills registered jobnets.

-T

Kills the root jobnet.

-J

Kills jobs.

-X {yes|no|auto}

Specify whether to automatically select the current unit for operation from the units listed in a planning group. The units in the job group are not, however, automatically selected regardless of the specified value. You cannot omit a root jobnet name.

- `yes`
Specify this to automatically select a target unit.
When specifying a unit name in the command, omit a root jobnet name in a planning group.
- `no`
Specify this if you do not want to automatically select a target unit.
You must specify a unit for which the command will operate. You cannot omit a root jobnet name in a planning group.
- `auto`
Whether a target unit will automatically be selected depends on how the unit name is specified.
 - If you want to automatically select a target unit
Specify a unit name without a root jobnet name in a planning group.
 - If you do not want to automatically select a target unit
Specify a unit name with a root jobnet name in a planning group. The command will operate for the specified unit only. However, if there is a unit having the same name as the path name specified without a root jobnet name in a planning group, a root jobnet name is assumed to be omitted so that a target unit will be selected automatically.

job-name-or-jobnet-name-or-job-group-name

Specify the name of the job or jobnet you want to kill. You can also specify a job, jobnet, or job group name with the `-R`, `-E`, `-T`, or `-J` option.

You can specify a character string of 1 to 930 bytes.

You can specify more than one job, jobnet, or job group name. If you want to specify a jobnet name, however, you can specify only a root jobnet name. You cannot specify a manager job group name or manager jobnet name.

You can specify a logical host name or execution ID as a job, jobnet or job group name. If you specify an execution ID, however, the `-B` option is disabled. For details about how to specify the execution ID, see [1.1 Command syntax](#).

Notes

- Either of the following users can kill a job:

- A user granted the operation privilege when the job and all jobnets that contain the job were defined or when their attributes were changed
- A JP1 user mapped to the OS user who has Administrators or superuser privileges
Note, however, that if `yes` is set after changing the `ADMACLIMIT` environment setting parameter from its default, even a JP1 user who was mapped to an OS user with Administrators or superuser privileges must have the operation privilege.
- Either of the following users can kill a jobnet:
 - A user granted the operation privilege when the jobs contained in the jobnet and the jobnet were defined or when their attributes were changed
 - A JP1 user mapped to the OS user who has Administrators or superuser privileges
Note, however, that if `yes` is set after changing the `ADMACLIMIT` environment setting parameter from its default, even a JP1 user who was mapped to an OS user with Administrators or superuser privileges must have the operation privilege.
- This command terminates abnormally if you execute it when a scheduler service is not running.
- This command terminates abnormally if you attempt to kill a job or jobnet which is not running.
- You can kill only processes started by JP1/AJS3. If a process has been started by JP1/AJS3, however, you may not be able to kill it depending on the status of the process.
- You cannot use this command for units subordinate to remote jobnets.
- This command terminates abnormally if the target job or jobnet is being suspended.
- When you specify that a target unit automatically be selected from the units in a planning group, an error occurs if you do not have the appropriate operation privilege for the automatically selected unit.
- When the `-X` option is omitted, a target unit in a planning group is determined according to the value specified for the `AJSAUTOJUDGE` environment variable.
- For an explanation of how to specify the name of a unit in a planning group, see [Additional information in *ajsplan* in 3. Commands Used for Normal Operations.](#)
- You cannot forcibly terminate a jobnet connector.
- You can forcibly terminate units that are in any of the following statuses:
 - A job that is queued or running
If the job is a queueless job, you can also forcibly terminate the job in *Waiting for execution* status.
 - A root jobnet that is in *Now running*, *Running + Warning*, *Running + Abend*, or *Now monitoring* status
- If this command is executed, communication and database updating take place in JP1/AJS3. Therefore, if this command is executed many times in a short period, the overall JP1/AJS3 system will become heavily loaded and might affect operations. For example, processing might be delayed. If you need to repeat execution of the command, pause for a few seconds between each execution. In particular, you must be careful when you execute the command for event jobs, custom event jobs or for a jobnet that uses event jobs or custom event jobs, because of the limit values for event jobs and custom event jobs. For details about the limit values for event jobs and custom event jobs, see [B.8 Limits for the event/action control in the *JP1/Automatic Job Management System 3 System Design \(Configuration\) Guide*.](#)

Return values

| | |
|--|--------------|
| 0 | Normal end |
| Multiple of 4 within the range from 4 to 124 | Abnormal end |

Additional information

- If you kill a particular job, other jobs and jobnets in the jobnet containing the killed job, say jobnet A, will be executed as scheduled. To prevent other jobs and jobnets from running, you should stop the execution of jobnet A beforehand. You can use the `ajsintrpt` command to stop the execution of a jobnet.
- Under UNIX, the system uses `SIGKILL` to kill a job or jobnet, so that you can also kill any application which captures a signal.
- If you kill the generation in the Now monitoring status, that generation enters the Monitor terminated status. The generation in the Now running status or the generation in the Wait for start cond status waiting for the end of the generation in the Now running status is not killed.
- This command ends when a request is made to the scheduler service to kill the specified unit. The command does not wait for the specified unit to finish.

Example

The following command kills job `job1`. Assume that this job is contained in the root jobnet, `net1`, and that the job group name is set in environment variable `AJSPATH` (if environment variable `AJSPATH` contains the job group name, you can omit the specification of the job group when executing the command).

```
ajskill net1/job1
```

ajsleave

Format

```
ajsleave
  [-F service-name]
  [-B execution-registration-number
    | -b [[year/]month/]day [-e [[year/]month/]day]
    | -v [[year/]month/]day [-w [[year/]month/]day]]
  [-R]
  [-E]
  [-T]
  jobnet-name-or-job-group-name...
```

Description

Cancels the execution registration of a jobnet.

Execution privileges

You must have any of the following JP1 privileges:

- JP1_AJS_Admin privilege
- JP1_AJS_Manager privilege
- JP1_AJS_Operator privilege

Arguments

-F *service-name*

Specify the name of the target scheduler service.

You can specify a character string of 1 to 30 bytes.

-B *execution-registration-number*

Specify the execution registration number of the jobnet whose execution registration you want to cancel.

The following table lists the execution registration numbers you can specify:

Table 3–11: Execution registration numbers

| Execution registration number | Description |
|-------------------------------|---|
| all | All execution registration information for the jobnet |
| schedule | Schedule information |
| result | Result information |
| YYYYMMDDNNN# | Specified execution schedule or result |
| YYYYMMDD# | Specified execution schedule or result |

#

The meaning of the characters is as follows:

YYYY: Year of the scheduled date of execution

MM: Month of the scheduled date of execution

DD: Day of the scheduled date of execution

NNN: Execution registration sequence number for the scheduled date of execution

For details of the execution registration number, see *4.5.13 Methods of specifying generations when executing commands* in the manual *JP1/Automatic Job Management System 3 Overview*.

If you omit this option, the system assumes `-B all`.

You cannot specify this option with the `-b`, `-e`, `-v`, or `-w` option.

-b [[*year*/] *month*/] *day*

Specify the start date of the period for which you want to cancel registration as a calendar date.

The start time is the base time.

- *year*

You can specify a value between 1994 and the value of the `SCHEDULELIMIT` environment setting parameter for the year. For details about the `SCHEDULELIMIT` environment setting parameter, see *20.4.2(123) SCHEDULELIMIT* in the *JP1/Automatic Job Management System 3 Configuration Guide*.

- *month*

You can specify a value between 1 (or 01) and 12.

- *day*

You can specify a value between 1 (or 01) and 31.

If you omit the specification of the year or both the year and month for this option, the system assumes the following values:

year: The *year* in which you executed the command

year/month: The year and month in which you executed the command

You cannot specify this option with the `-B`, `-v`, or `-w` option.

-e [[*year*/] *month*/] *day*

Specify the end date of the period for which you want to cancel registration as a calendar date.

The end date must be the same as or follow the start date.

If you omit this option, the system assumes the date specified with the `-b` option.

The end time is the base time plus 23 hours: 59 minutes; 59 seconds.

- *year*

You can specify a value between 1994 and the value of the `SCHEDULELIMIT` environment setting parameter for the year. For details about the `SCHEDULELIMIT` environment setting parameter, see *20.4.2(123) SCHEDULELIMIT* in the *JP1/Automatic Job Management System 3 Configuration Guide*.

- *month*

You can specify a value between 1 (or 01) and 12.

- *day*

You can specify a value between 1 (or 01) and 31.

If you omit the specification of the year or both the year and month for this option, the system assumes the following values:

year: The *year* in which you executed the command

year/month: The year and month in which you executed the command

You must specify this option with the `-b` option. You cannot specify this option with the `-B`, `-v`, or `-w` option.

`-v` [[*year*/] *month*/] *day*

Specify the start date of the period for which you want to cancel registration as an execution date.

The start time is the base time.

- *year*
You can specify a value between 1994 and the value of the `SCHEDULELIMIT` environment setting parameter for the year. For details about the `SCHEDULELIMIT` environment setting parameter, see 20.4.2(123) *SCHEDULELIMIT* in the *JPI/Automatic Job Management System 3 Configuration Guide*.
- *month*
You can specify a value between 1 (or 01) and 12.
- *day*
You can specify a value between 1 (or 01) and 31.

If you omit the specification of the year or both the year and month for this option, the system assumes the following values:

year: The *year* in which you executed the command

year/month: The year and month in which you executed the command

You cannot specify this option with the `-B`, `-b`, or `-e` option.

`-w` [[*year*/] *month*/] *day*

Specify the end date of the period for which you want to cancel registration as an execution date.

The end date must be the same as or follow the start date.

If you omit this option, the system assumes the date specified with the `-v` option.

The end time is the base time plus 23 hours; 59 minutes; 59 seconds.

- *year*
You can specify a value between 1994 and the value of the `SCHEDULELIMIT` environment setting parameter for the year. For details about the `SCHEDULELIMIT` environment setting parameter, see 20.4.2(123) *SCHEDULELIMIT* in the *JPI/Automatic Job Management System 3 Configuration Guide*.
- *month*
You can specify a value between 1 (or 01) and 12.
- *day*
You can specify a value between 1 (or 01) and 31.

If you omit the specification of the year or both the year and month for this option, the system assumes the following values:

year: The *year* in which you executed the command

year/month: The year and month in which you executed the command

You must specify this option with the `-v` option. You cannot specify this option with the `-B`, `-b`, or `-e` option.

-R

Cancels execution registration for all units contained in the specified job group.

If you specify this option with the `-E` and/or `-T` options, the system cancels the execution registration for jobnets according to the specification of each option.

If you do not specify the `-T` option together with the `-R` option, the registration of all the units is canceled, and the registration cancel processing for the units except the root jobnet ends abnormally.

-E

Cancels execution registration for all registered jobnets.

-T

Cancels execution registration for the root jobnet.

jobnet-name-or-job-group-name

Specify the name of the jobnet whose execution registration you want to cancel. You can also specify a jobnet name or job group name with the `-R`, `-E`, or `-T` option.

You can specify a character string of 1 to 930 bytes.

You can specify more than one jobnet name or job group name. If you want to specify a jobnet name, however, you can specify only a root jobnet name. You cannot specify a manager job group name or manager jobnet name.

You can specify a logical host name or execution ID as a jobnet or job group name. If you specify an execution ID, however, the `-B` option is disabled. For details about how to specify the execution ID, see [1.1 Command syntax](#).

Notes

- Either of the following users can cancel the registration of a jobnet for execution:
 - A user granted the operation privilege when the jobs contained in the jobnet and the jobnet were defined or when their attributes were changed
 - A JP1 user mapped to the OS user who has Administrators or superuser privileges
Note, however, that if `yes` is set after changing the `ADMACLIMIT` environment setting parameter from its default, even a JP1 user who was mapped to an OS user who has Administrators or superuser privileges must have the operation privilege.
- This command terminates abnormally if you execute it when a scheduler service is not running.
- You can cancel execution registration for the root jobnet only.
- This command terminates abnormally if the jobnet that you attempt to cancel execution registration is running.
- This command terminates abnormally if the target jobnet is being suspended.

Return values

| | |
|--|--------------|
| 0 | Normal end |
| Multiple of 4 within the range from 4 to 124 | Abnormal end |

Additional information

The specification method for the `-b`, `-e`, `-v`, and `-w` options might differ depending on the value specified in the `ROOTJOBNETSCHEDULERANGE` environment setting variable. The following describes how to specify the `-b`, `-e`, `-v`, and `-w` options when the schedule definition is based on 48 hours and 24 hours:

- When the root jobnet schedule definition is based on 48 hours

When the root jobnet schedule definition is based on 48 hours, an execution date may differ from the corresponding calendar date.

When the base time is 7:00, for example, registering the execution start date/time for `/jobnet001` as 2010/7/2 32:00 results in the calendar date being July 3 and the execution date being July 2. (The calendar date is the date on which the jobnet will be started, assuming a day is 24 hours, so that 32:00 on July 2, 2010 is assumed as 8:00 on July 3, 2010.) You can cancel registration by specifying either of the following commands because the `-b` and `-e` options specify a calendar date while the `-v` and `-w` options specify an execution date:

- For a calendar date

```
ajsleave -b 2010/7/3 -e 2010/7/3 /jobnet001
```

- For an execution date

```
ajsleave -v 2010/7/2 -w 2010/7/2 /jobnet001
```

Note, however, that you cannot use the `-b` and `-e` options when canceling registration of a jobnet execution scheduled at or after 24:00 on December 31 in the year set for the `SCHEDULELIMIT` environment setting parameter. To cancel registration of such a jobnet, use the `-v` and `-w` options. This is because if you use the `-b` and `-e` options, the time you specify will be at or after 0:00 on January 1 of the year after the year set for the `SCHEDULELIMIT` environment setting parameter. For the `-b` and `-e` options, you can specify a four-digit year in the range from 1994 to the value of the `SCHEDULELIMIT` environment setting parameter. For details about the `SCHEDULELIMIT` environment setting parameter, see *20.4.2(123) SCHEDULELIMIT* in the *JP1/Automatic Job Management System 3 Configuration Guide*.

- When the root jobnet schedule definition is based on 24 hours

When the root jobnet schedule definition is based on 24 hours, an execution date equals the corresponding calendar date.

When the base time is 7:00, for example, registering the execution start date/time for `/jobnet001` as 2010/7/2 32:00 results in the calendar date being July 3 and the execution date being July 3. You can cancel registration by specifying either of the following commands because the `-b` and `-e` options specify a calendar date while the `-v` and `-w` options specify an execution date:

- For a calendar date

```
ajsleave -b 2010/7/3 -e 2010/7/3 /jobnet001
```

- For an execution date

```
ajsleave -v 2010/7/3 -w 2010/7/3 /jobnet001
```

Example

The following command cancels the execution registration of jobnet net1:

```
ajsleave net1
```

ajslogprint

Format

```
ajslogprint
  [-b extract-start-day]
  [-e extract-end-day]
  [-k log-type]
  [-F service-name]
  [-u unit-name]
  [-m message-ID]
  scheduler-log-file-name
```

Description

The `ajslogprint` command extracts log records that match the specified conditions from the scheduler log, and outputs the extracted log records.

Execution privileges

None

Arguments

-b *extract-start-day*

Specify the start day of the range (term) for which you want to extract log records.

You can specify the day in `[YYYY/]MM/DD` format.

- *YYYY*
Specify a numeric value from 1994 to 2099 as the year. If you omit this element, the year that the command is executed is assumed.
- *MM*
Specify a numeric value from 1 to 12 (or 01 to 12) as the month.
- *DD*
Specify a numeric value from 1 to 31 (or 01 to 31) as the day.

If this option is specified, the command does not extract the log records output when `no` is specified for the `AJSLOGOUTPUTYEAR` or `HOSTLOGOUTPUTYEAR` environment setting parameter (log records that do not include year information).

If this option is omitted, log records are extracted from the beginning of the log.

-e *extract-end-day*

Specify the end day of the range (term) for which you want to extract log records.

You can specify the day in `[YYYY/]MM/DD` format.

- *YYYY*
Specify a numeric value from 1994 to 2099 as the year. If you omit this element, the year that the command is executed is assumed.

- *MM*
Specify a numeric value from 1 to 12 (or 01 to 12) as the month.
- *DD*
Specify a numeric value from 1 to 31 (or 01 to 31) as the day.

If this option is specified, the command does not extract the log records output when `no` is specified for the `AJSLOGOUTPUTYEAR` or `HOSTLOGOUTPUTYEAR` environment setting parameter (log records that do not include year information).

If this option is omitted, log records to the end of the log are extracted.

-k *log-type*

Specify the type of log you want to extract.

For the log types that can be specified, see *C.1 Log entries output by the scheduler services* in the manual *JP1/Automatic Job Management System 3 Troubleshooting*.

If this option is omitted, all types of log records are subject to extraction.

-F *service-name*

Specify the name of the scheduler service for which you want to extract.

You can specify a character string of 1 to 30 bytes.

If this option is omitted, log records for all scheduler services are subject to extraction.

-u *unit-name*

Specify the full path name of the unit for which you want to extract.

You can specify a character string of 1 to 930 bytes.

If this option is specified, log records that do not contain the specified unit name are not subject to extraction. Also note that only the log records for the specified unit are subject to extraction. The log records for subordinate units of the unit are not subject to extraction.

If this option is omitted, log records for all units are subject to extraction.

-m *message-ID*

Specify the message you want to extract.

You can specify a character string of 1 or 10 bytes.

To extract only the log records that report normal termination of operation for log types of a scheduler service or unit (log types beginning with C), specify 0.

To extract log records that contain a specific message, specify the ID of the message in `KAVSxxxx-Z` format.

If this option is omitted, log records containing any message are subject to extraction.

scheduler-log-file-name

Specify a scheduler log file name.

You can specify a character string of 1 to 255 bytes.

You can specify only one scheduler log file name.

Notes

- If the `-k`, `-F`, `-u`, and `-m` options are specified, the conditions specified for these options are combined as an AND extraction.
- You cannot use a regular expression to specify service names, unit names, message IDs, or scheduler log file names.
- If you want to extract log records across two scheduler log files, merge these files into one file, and then execute the command.
- If a log record in an incorrect format is found, output the KAVS0476-E message, and resume the processing from the next line.

Arguments that can be specified when executing the command from JP1/AJS3 - View

You can specify the following arguments when executing the `ajslogprint` command from JP1/AJS3 - View:

| No. | Arguments | Required? |
|-----|--------------------------------------|-----------|
| 1 | <code>-b extract-start-day</code> | -- |
| 2 | <code>-e extract-end-day</code> | -- |
| 3 | <code>-k log-type</code> | -- |
| 4 | <code>-F service-name</code> | Y |
| 5 | <code>-u unit-name</code> | -- |
| 6 | <code>-m message-ID</code> | -- |
| 7 | <code>scheduler-log-file-name</code> | Y |

Legend:

Y: Required

--: Optional

You cannot specify any other options when executing the `ajslogprint` command from JP1/AJS3 - View.

For details about how to execute JP1/AJS3 commands from JP1/AJS3 - View, see *10.4 Executing JP1/AJS3 commands from JP1/AJS3 - View* in the *JP1/Automatic Job Management System 3 Operator's Guide*.

Return values

| | |
|----|--|
| 0 | Normal end. |
| 4 | Any of the following results: <ul style="list-style-type: none">• Arguments are specified incorrectly.• Log records that match the conditions do not exist.• The format of the scheduler log file is incorrect.• The scheduler log file name is not specified.• The scheduler log file name is too long. |
| 12 | Insufficient memory |
| 24 | The specified scheduler log file cannot be accessed. |
| 36 | An error occurred while the scheduler log file is being loaded. |

Example 1

In this example, the command extracts and outputs log records related to all operations for /net1 in the period from October 1, 2010 to March 31, 2011 from the scheduler log of the scheduler service AJSROOT1.

In Windows:

```
ajslogprint -b 2010/10/01 -e 2011/03/31 -u /net1 "C:\Program Files\HITACHI\JP1AJS2\log\schedule\AJSROOT1\ajs-log1.log"
```

In UNIX:

```
ajslogprint -b 2010/10/01 -e 2011/03/31 -u /net1 /var/opt/jplajs2/log/schedule/AJSROOT1/ajs-log1.log
```

Example 2

In this example, from the scheduler log of the scheduler service AJSROOT1, the command extracts and outputs log records related to unit creation (C304) in the period from October 1, 2010 to March 31, 2011.

In Windows:

```
ajslogprint -b 2010/10/01 -e 2011/03/31 -k C304 "C:\Program Files\HITACHI\JP1AJS2\log\schedule\AJSROOT1\ajs-log1.log"
```

In UNIX:

```
ajslogprint -b 2010/10/01 -e 2011/03/31 -k C304 /var/opt/jplajs2/log/schedule/AJSROOT1/ajs-log1.log
```

ajsname

Format

```
ajsname
  [-F service-name]
  [-V]
  [-R]
  [{-L|-E}]
  [-T]
  [{-G|-N|-J}]
  [-I]
  job-name-or-jobnet-name-or-job-group-name...
```

Description

Outputs a unit name to the standard output file.

Execution privileges

You must have any of the following JP1 privileges:

- JP1_AJS_Admin privilege
- JP1_AJS_Manager privilege
- JP1_AJS_Editor privilege
- JP1_AJS_Operator privilege
- JP1_AJS_Guest privilege

Arguments

-F *service-name*

Specify the name of the target scheduler service.

You can specify a character string of 1 to 30 bytes.

-V

Does not output unit names in remote jobnets.

-R

Outputs all the unit names in a specified unit.

If you specify this option with the **-L**, **-E**, **-T**, **-G**, **-N**, and/or **-J** options, the system outputs the unit names according to the specification of each option.

-I

Outputs the names of the jobnets not registered for execution.

You cannot specify this option with the **-E** or **-G** option.

-E

Outputs the names of the jobnets registered for execution.

You cannot specify this option with the `-L` or `-G` option.

-T

Outputs the root jobnet name.

You cannot specify this option with the `-G` or `-J` option.

-G

Outputs a job group name.

You cannot specify this option with the `-L`, `-E`, `-T`, `-N`, or `-J` option.

-N

Outputs a jobnet name.

You cannot specify this option with the `-G` or `-J` option.

-J

Outputs a job name.

You cannot specify this option with the `-T`, `-G`, or `-N` option.

-I

Specify this option during troubleshooting to output the full unit name by specifying the unit ID that is output in an error message. Do not use the option other than for troubleshooting.

You cannot specify this option together with the `-V`, `-R`, `-E`, `-L`, `-T`, `-G`, `-N`, or `-J` option.

job-name-or-jobnet-name-or-job-group-name

Specify the name of the job, jobnet or job group that you want to output to the standard output file. You can also specify a job name, jobnet name, or job group name with the `-R`, `-L`, `-E`, `-T`, `-G`, `-N`, or `-J` option.

You can specify a character string of 1 to 930 bytes.

You can specify more than one job name, jobnet name or job group name.

You cannot specify a logical host name or execution ID as a job, jobnet or job group name.

When specifying the `-I` option, specify the unit ID in decimal notation (do not specify the unit name).

Notes

- Either of the following users can output a unit name:
 - A user granted the reference privilege when the units contained in the unit were defined or when their attributes were defined
 - A JP1 user mapped to the OS user who has Administrators or superuser privileges

Note, however, that if `yes` is set after changing the `ADMACLIMIT` environment setting parameter from its default, even a JP1 user who was mapped to an OS user with Administrators or superuser privileges must have the reference privilege.

- If the command is executed for a release target jobnet (root jobnet for which release entry is made), the unit names in the jobnet definitions in *Being applied* status are output.

Return values

| | |
|--|--------------|
| 0 | Normal end |
| Multiple of 4 within the range from 4 to 124 | Abnormal end |

Example1

The following command outputs all the job names in the jobnet `/GRP/net1` to the standard output file.

```
ajsname -RJ /GRP/net1
```

Output example 1

```
/GRP/net1/job1  
/GRP/net1/job2  
/GRP/net1/n1/job  
/GRP/net1/n2/job
```

Example2

The following command outputs the full name of a unit whose unit ID is 10:

```
ajsname -I 10
```

Output example 2

```
/group
```

ajsplan

Format

```
ajsplan
  [-F service-name]
  [[-d[[year/]month/]day] [-t hours[:minutes]]] [-p] [-i]
    | [-b day] [-c minutes] [-p] [-i]
    | -q[-p|-w] [-i] |-p|-u]
  [-h|-r]
  [-n {priority-value|none}]
  [-s {none|hours:minutes|M-minutes|U-minutes|C-minutes}]
  [-e {none|hours:minutes|M-minutes|U-minutes|C-minutes}]
  [-f {none|minutes}]
  [-B execution-registration-number]
  [-j|-m {hours:minutes|M-minutes|unlimited}]
    -k {number-of-times|unlimited}]
  [-l {y|n}]
  [-xw {enable|disable} -xn unit-whose-end-is-being-waited-for]
  [-R]
  [-E]
  [-T]
  [-N|-J]
  [-X {yes|no|auto}]
  job-name-or-jobnet-name-or-job-group-name...
```

Description

1. Temporarily changes the next execution schedule of a jobnet registered for execution and it follows the schedule defined for the jobnet.
2. Temporarily changes the execution order control method for the jobnet to which the jobnet connector is connected if the root jobnet execution order is controlled. (Note that this change applies to only root jobnets and planning groups.)
3. Temporarily holds, releases, cancels, or resumes a job and it follows by execution according to the attributes defined for the job.
4. Temporarily enables or disables a wait condition assigned to a job or jobnet. (After executing with the modified wait condition setting, the job runs according to the definition.)

This feature is only available when the database uses a standard configuration.

Execution privileges

You must have any of the following JP1 privileges:

- JP1_AJS_Admin privilege
- JP1_AJS_Manager privilege
- JP1_AJS_Operator privilege

Arguments

-F *service-name*

Specify the name of the target scheduler service.

You can specify a character string of 1 to 30 bytes.

-d [[*year/*] *month/*] *day*

Specify the next execution start date to be changed temporarily.

You cannot specify this option for a job. If you set this option with the `-p` option in a root jobnet and push ahead the next schedule, the former schedule for the next execution is canceled. If you push ahead the next schedule without specifying the `-p` option, the schedule is added.

For a nested jobnet, the command only modifies the scheduled date/time regardless of whether the `-p` option is specified.

- *year*
You can specify a value between 1994 and the value of the `SCHEDULELIMIT` environment setting parameter for the year. For details about the `SCHEDULELIMIT` environment setting parameter, see 20.4.2(123) `SCHEDULELIMIT` in the *JPI/Automatic Job Management System 3 Configuration Guide*.
- *month*
You can specify a value between 1 (or 01) and 12.
- *day*
You can specify a value between 1 (or 01) and 31.

If you omit the year or the year/month in this option, the following values are assumed.

year: Year when the command was executed

year/month: Year and month when the command was executed

Assuming that the `-t` option has been specified instead of this option, the system assumes the *year/month/day* value if a jobnet with the generation as the target of temporary change is scheduled to be executed next time. Otherwise, an error takes place.

-t *hours* [: *minutes*]

Specify the absolute time when to start the next execution.

You cannot specify this option for a job. If you set this option with the `-p` option in a root jobnet and push ahead the next schedule, the former schedule for the next execution is canceled. If you push ahead the next schedule without specifying the `-p` option, the schedule is added.

For a nested jobnet, the command only modifies the scheduled date/time regardless of whether the `-p` option is specified.

If you specify this option with the `-i` option, the next execution schedule time for any jobnets in the specified jobnet are also changed relatively.

- *hours*
You can specify a value between 0 (or 00) and 47.
- *minutes*
You can specify a value between 0 (or 00) and 59. If you omit this option, the system assumes 0.

If you specify the `-d` option instead of this option, and if the jobnet of the generation for which a temporary change is being made has a schedule for execution, the scheduled time of execution (*hours : minutes*) is assumed.

If the jobnet has no schedule for execution, an error occurs.

You can also temporarily change the jobnet execution start time from JP1/AJS3 - View. For details about the operation procedure in JP1/AJS3 - View, see *9.3.1 Changing the execution start time of a jobnet* in the *JP1/Automatic Job Management System 3 Operator's Guide*.

-p

Cancels the next execution schedule for a jobnet or job.

If you have already temporarily changed the next execution schedule, reset the current status using the `-u` option, then execute this command.

If you specify this option with the `-d`, `-t`, `-b`, `-c`, or `-q` option in a root jobnet to push ahead the next schedule, the next execution schedule is canceled.

For a nested jobnet, this option does not take effect if specified with the `-d`, `-t`, `-b`, `-c`, or `-q` option.

-b day

Specify the execution start date you want to change temporarily. To specify it, use the number of days relative to the scheduled execution day in the generation for which a temporary change should be made.

If there is no schedule for execution, an error occurs.

You can specify a value between -99 and 99 (days) except 0.

If you specify the `-c` option instead of this option, 0 days are assumed as the relative number of days.

You cannot specify this option for a job. If you set this option with the `-p` option in a root jobnet and push ahead the next schedule, the former schedule for the next execution is canceled. If you push ahead the next schedule without specifying the `-p` option, the schedule is added.

For a nested jobnet, the command only modifies the scheduled date/time regardless of whether the `-p` option is specified.

If you specify this option with the `-i` option, the next execution schedule time for any jobnets in the specified jobnet are also changed relatively.

-c minutes

Specify the execution start time you want to change temporarily. To specify it, use the number of minutes relative to the scheduled execution time in the generation for which a temporary change should be made.

If there is no schedule for execution, an error occurs.

You can specify a value between -2,879 and 2,879 (minutes) except 0.

You cannot specify this option for a job. If you set this option with the `-p` option in a root jobnet and push ahead the next schedule, the former schedule for the next execution is canceled. If you push ahead the next schedule without specifying the `-p` option, the schedule is added.

For a nested jobnet, the command only modifies the scheduled date/time regardless of whether the `-p` option is specified.

If you specify this option with the `-i` option, the next execution schedule time for any jobnets in the specified jobnet are also changed relatively.

-q

The jobnet generation scheduled to be executed the next time is immediately executed as soon as the command is entered regardless of the schedule definition for the root jobnet. If you specify this option for a nested jobnet, it modifies the base time for the execution date for a root jobnet.

If you specify this option with the `-p` option in a root jobnet, the former schedule for the next execution is canceled. Pushing ahead the next schedule without specifying the `-p` option results in the addition of a schedule. Executing the command with the `-p` option specified or postponing the next schedule without specifying the `-p` option results in the moving schedule to a later time.

For a nested jobnet, the command only modifies the scheduled date/time regardless of whether the `-p` option is specified.

If you specify this option with the `-i` option, the next execution schedule time for any jobnets in the specified jobnet are also changed relatively.

You can also use JP1/AJS3 - View to immediately execute a jobnet that has already been scheduled. For details about operation in JP1/AJS3 - View, see *9.4 Immediately executing the execution schedule of a jobnet* in the *JP1/Automatic Job Management System 3 Operator's Guide*.

-w

Ends the command after the end of jobnet execution.

Only specify this option to register the root jobnet for immediate execution. You cannot specify it when the root jobnet is to be held or undergo a planned temporary change.

Even if you specify this option, the command will terminate without waiting for the end of the jobnet in the following cases:

- The scheduler service stops during jobnet execution.
- The generation with a termination wait is left unexecuted when using the carryover method.
- The generation with a termination wait is deleted. (For example, the generation that is unregistered for execution or registered for immediate execution or fixed execution discontinues its execution.)
- The generation with a termination wait specified is left unplanned. (For example, the subsequent schedule is left unplanned as a result of a schedule or calendar change in a jobnet registered for planned execution)

You can specify this option only in the root jobnet. Specify together with the `-q` option. You cannot specify this option with the `-m` or `-k` option.

-i

Relatively changes the starting time for executing a specified job.

You can specify these options only for a jobnet. Specify this option with the `-d`, `-t`, `-b`, `-c`, or `-q` option.

-u

Resets the schedule changed temporarily by the `-d`, `-t`, `-b`, `-c`, `-q`, or `-p` option to the original status.

If you temporarily change the schedule multiple times, the information prior to the first change is restored.

-h

Temporarily holds the next jobnet or job execution.

-r

Temporarily releases a held jobnet or job.

-n {*priority-value* | none }

Temporarily changes the priority of jobnet execution.

You cannot specify this option for a job.

- *priority-value*

You can specify a value between 1 and 5.

The lowest priority is 1 and the highest is 5.

- none

Sets the priority of execution defined for the jobnet.

-s {none | *hours : minutes* | *M-minutes* | *U-minutes* | *C-minutes* }

Specify the next delayed start time.

You can specify this option only for a jobnet.

- none

Does not monitor the delayed start.

- *hour : minutes*

Specify absolute hours and minutes.

You can specify a value between 0 (or 00) and 47 for the hours.

You can specify a value between 0 (or 00) and 59 for the minutes.

- *M-minutes*

Specify the next delayed start time by the relative minutes from the time when the root jobnet starts to be executed.

You can specify a value between 1 (or 01) and 2,879 (minutes).

- *U-minutes*

Specify the next delayed start time by the relative minutes from the time when the upper-level jobnet starts to be executed.

You can specify a value between 1 (or 01) and 2,879 (minutes).

- *C-minutes*

Specify the next delayed start time by the relative minutes from the time when the jobnet starts to be executed.

You can specify a value between 1 (or 01) and 2,879 (minutes).

-e {none | *hours : minutes* | *M-minutes* | *U-minutes* | *C-minutes* }

Specify the next delayed end time.

You cannot specify this option for a job.

- none

Does not monitor the delayed end.

- *hour : minutes*

Specify an absolute time.

You can specify a value between 0 (or 00) and 47 for the hours.

You can specify a value between 0 (or 00) and 59 for the minutes.

- *M-minutes*

Specify the next delayed end time by the relative minutes from the time when the root job net starts to be executed. You can specify a value between 1 (or 01) and 2,879 (minutes).

- *U-minutes*

Specify the next delayed end time by the relative minutes from the time when the upper jobnet starts to be executed. You can specify a value between 1 (or 01) and 2,879 (minutes).

- *C-minutes*

Specify the next delayed end time by the relative minutes from the time when the jobnet starts to be executed. You can specify a value between 1 (or 01) and 2,879 (minutes).

-f {none | minutes}

Specify the end delay monitoring time using the time required to execute the next jobnet or remote jobnet.

You cannot specify this option for a job.

- none

Does not monitor the delayed end based on the time required for execution.

- minutes

Monitors the delayed end based on the time required for execution.

You can specify a value between 1 (or 01) and 2,879 minutes.

-B execution-registration-number

Specify the execution registration number of a jobnet whose next execution schedule is to be changed temporarily, in the *YYYYMMDDNNN* format. The meaning of *YYYYMMDDNNN* is as follows:

YYYY: Year of the scheduled date of execution

MM: Month of the scheduled date of execution

DD: Day of the scheduled date of execution

NNN: Execution registration sequence number for the scheduled date of execution

For details of the execution registration number, see *4.5.13 Methods of specifying generations when executing commands* in the manual *JP1/Automatic Job Management System 3 Overview*.

-j

Invalidates start conditions set for a jobnet.

You can specify this option only in the root jobnet. You cannot specify this option with the *-m* or *-k* option.

-m {hours:minutes | M-minutes | unlimited}

Specify the wait time until start conditions are met.

You can specify this option only for the root jobnet. Specify this option with the *-k* option. You cannot specify it with the *-w* or *-j* option.

- *hour:minutes*

Specify the wait time by the absolute time.

You can specify a value between 0 (or 00) and 47 for the hours.

You can specify a value between 0 (or 00) and 59 for the minutes.

- *M-minutes*

Specify the wait time by relative minutes from the time when the jobnet starts to be executed.

You can specify a value between 1 (or 01) and 2,879 (minutes).

- *unlimited*

Waits for an unlimited period of time until the conditions are met.

-k {*number-of-times*|*unlimited*}

Specify the number of times the system waits for start conditions to be met.

You can specify this option only in the root jobnet. Specify this option with the `-m` option. You cannot specify it with the `-w` or `-j` option.

- *number-of-times*

You can specify a value between 1 and 999 (times).

- *unlimited*

Sets an unlimited number of times for waiting until the conditions are met.

-l {*y*|*n*}

Specify this option to temporarily change the execution order control method only if execution order control is enabled in the unit definition for a root jobnet or planning group.

- *y*: The execution order is synchronous with the jobnet connector.

- *n*: The execution order is asynchronous with the jobnet connector.

You can specify this option for only a jobnet or planning group to which a jobnet connector is connected.

-xw {*enable*|*disable*}

Specify this option to temporarily enable or disable a wait condition assigned to a job or jobnet.

- *enable*

Enables the wait condition.

- *disable*

Disables the wait condition.

You can specify this option only for units with wait conditions.

Use this option together with the `-xn` option. The `-xn` option specifies the unit whose end is being waited for to which the change applies.

This feature is only available when the database uses a standard configuration.

You cannot specify multiple `-xw` options. Execute the command multiple times if you want to operate on multiple units with wait conditions.

You cannot specify this option with options other than `-R`, `-E`, `-T`, `-N`, `-J`, `-B`, `-X`, or `-F`.

-xn *unit-whose-end-is-being-waited-for*

Specify the name of the unit whose end is being waited for by the job or jobnet whose wait condition you want to enable or disable by the `-xw` option. Note that if you specify only the unit name, the `AJSPATH` environment variable does not supply the rest of the path.

Specify this option together with the `-xw` option.

This feature is only available when the database uses a standard configuration.

You can specify a character string of 1 to 930 bytes as the name of the unit whose end is being waited for. You can also use regular expressions.

You cannot specify multiple `-xn` options. To modify a wait condition targeting multiple units whose ends are being waited for, either execute the command multiple times or use regular expressions to specify the unit names. If you use a regular expression, the command enables or disables the wait conditions for all units whose ends are being waited for that match the regular expression.

You cannot specify this option with options other than `-R`, `-E`, `-T`, `-N`, `-J`, `-B`, `-X`, or `-F`.

An error occurs when:

- You specify a nonexistent unit whose end is being waited for
- You specify a unit that is not assigned a wait condition
- The unit whose end is being waited for is deleted while the command is executing
- No units whose ends are being waited for match the regular expression

-R

Temporarily changes all the jobnets and jobs contained in the specified unit.

If you specify this option with the `-E`, `-T`, `-N`, and/or `-J` options, the system temporarily changes the jobnets or jobs according to the specification of each option.

-E

Temporarily changes the schedule of a jobnet registered for execution.

-T

Temporarily changes the schedule of the root jobnet.

-N

Temporarily changes the schedules of all jobnets.

You cannot specify this option with the `-J` option.

-J

Temporarily changes the job status.

You cannot specify this option with the `-N` option.

-X {yes|no|auto}

Specify whether to automatically select the current unit for operation from the units listed in a planning group. The units in the job group are not, however, automatically selected regardless of the specified value. You cannot omit a root jobnet name.

- **yes**
Specify this to automatically select a target unit.
When specifying a unit name in the command, omit a root jobnet name in a planning group.
- **no**
Specify this if you do not want to automatically select a target unit.
You must specify a unit for which the command will operate. You cannot omit a root jobnet name in a planning group.
- **auto**
Whether a target unit will automatically be selected depends on how the unit name is specified.
 - If you want to automatically select a target unit
Specify a unit name without a root jobnet name in a planning group.
 - If you do not want to automatically select a target unit
Specify a unit name with a root jobnet name in a planning group. The command will operate for the specified unit only. However, if there is a unit having the same name as the path name specified without a root jobnet name in a planning group, a root jobnet name is assumed to be omitted so that a target unit will be selected automatically.

job-name-or-jobnet-name-or-job-group-name

Specify the name of the job or jobnet whose schedule or status you want to temporarily change. You can also specify a job, jobnet, or job group name with the **-R**, **-N**, **-E**, or **-T** option.

You can specify a character string of 1 to 930 bytes.

You can specify more than one job, jobnet, or job group names. You cannot specify a manager job group name or manager jobnet name.

You can specify a logical host name or execution ID as a job, jobnet or job group name. If you specify an execution ID, however, the **-B** option is disabled. For details about how to specify the execution ID, see [1.1 Command syntax](#).

Notes

- Either of the following users can change the jobnet schedule temporarily:
 - A user granted the operation privilege when the units contained in the jobnet whose schedule is to be changed were defined or when their attributes were changed
 - A JP1 user mapped to the OS user who has Administrators or superuser privileges
Note, however, that if **yes** is set after changing the **ADMACLIMIT** environment setting parameter from its default, even a JP1 user who was mapped to an OS user who has Administrators or superuser privileges must have the operation privilege.
- Either of the following users can change the job status temporarily:
 - A user granted the operation privilege for the jobnets that contain the job whose status is to be changed
 - A JP1 user mapped to the OS user who has Administrators or superuser privileges
Note, however, that if **yes** is set after changing the **ADMACLIMIT** environment setting parameter from its default, even a JP1 user who was mapped to an OS user who has Administrators or superuser privileges must have the operation privilege.

- This command terminates abnormally if you execute it when a scheduler service is not running.
- This command ends abnormally when jobnets or jobs cannot be temporarily changed, as shown below:
 - You cannot temporarily change the `-d`, `-t`, `-b`, `-c`, `-q`, `-p`, `-u`, `-h`, `-r`, `-s`, `-j`, `-m`, or `-k` options if the status of the jobnet or job is *Now running* or *Wait for start cond.* (that is, jobnet or job that have started). However, you can temporarily change the `-p` option for root jobnets whose status is *Wait for start cond.* and whose start conditions are met. You can also temporarily change the `-h` or `-r` options for root jobnets whose status is *Wait for start cond.*
 - You cannot temporarily change the `-d`, `-t`, `-b`, `-c`, `-q`, `-p`, or `-u` options while the root jobnet has an end status or is in the *Wait for start time* status after a rerun, even if the root jobnet has not started.
 - You cannot temporarily change the `-d`, `-t`, `-b`, or `-c` options for a jobnet whose status is *Not sched. to exe.* if the `-d` and `-t` options are not specified at the same time.
 - You cannot temporarily change the `-p` option for jobnets whose status is *Not sched. to exe.* However, you can change the `-p` option for jobs whose status is *Not sched. to exe.*
 - You cannot temporarily change the `-d`, `-t`, `-b`, `-c`, `-q`, `-p`, `-u`, `-s`, `-e`, `-j`, `-m`, or `-k` options for jobnets and jobs that have an end status if the jobnet's execution ID or execution registration number is not specified.
- If you temporarily changed a jobnet or job that has ended execution, the change takes place when the unit is re-executed. For details on temporarily setting or canceling the hold attribute, see 4.5.6 *Temporarily changing the hold attribute of a job or jobnet* in the manual *JP1/Automatic Job Management System 3 Overview*.
- You cannot use this command for units subordinate to remote jobnets.
- Temporary changes to the priority of execution for remote jobnets do not take effect on the agent at the destination.
- When making temporary changes to the schedules for remote jobnets, you should pay attention to the post-change execution date and the starting date for executing a jobnet.
For the execution date, see 3.3.1 *Time formats and schedule rules for root jobnets* in the manual *JP1/Automatic Job Management System 3 Overview* or 3.3.2 *Defining a schedule* in the manual *JP1/Automatic Job Management System 3 Overview*.
- If the 48-hour schedule is used and you want to change the scheduled execution time of a root jobnet to a time after 24:00, specify the new execution time as an absolute time in the `-t` option. The new execution time, which is after 24:00, is treated as a continuation of the previous day. However, if you specify the new execution time as a relative time, it is treated as a time on the next day.
- If the 48-hour schedule is used for the schedule definition of a root jobnet, be careful with the base time. If the base time is not 0:00, operation might become complicated because the specified time might be different from the time in JP1/AJS3, or units that are specified to be executed in succession might not be executed in the intended order. For details, see 3.3.2 *Defining a schedule* in the manual *JP1/Automatic Job Management System 3 Overview*.
- This command terminates abnormally if the target jobnet or job is being suspended.
- When you specify that a target unit automatically be selected from the units in a planning group, an error occurs if you do not have the appropriate operation privilege for the automatically selected unit.
- When the `-X` option is omitted, a target unit in a planning group is determined according to the value specified for the `AJSAUTOJUDGE` environment variable.
- This command will terminate normally even if you use the `-r` option to release a unit that is not held.
- For a release target jobnet (root jobnet for which release entry is made), you cannot perform the following operations:
 - Changing the execution start date in a jobnet definition in *Being applied* status to a date after the release date, or canceling the date changing to set the execution start date to a date after the release date
 - Changing the execution start date in a jobnet definition in *Release wait* status to a date before the release date, or canceling the date changing to set the execution start date to a date before the release date
- You can execute up to 50 instances of the following two commands at the same time:

- The `ajsplan` command with the `-w` option specified
- The `ajsentry` command with the `-w` option specified

If there are 50 instances of the two commands already running, the next instance terminates abnormally.

Return values

| | |
|--|--------------|
| 0 | Normal end |
| Multiple of 4 within the range from 4 to 124 | Abnormal end |

Additional information

- You can also temporarily change the schedule of a jobnet registered for immediate execution or the state of a job.
- The following example definition describes how to specify the name of a unit in a planning group:

Example planning group definition

Assume you modify a unit named `/net1/job1` to create root jobnets named `net1-1` and `net1-2` in a planning group named `/net1`. Under `net1-1` and `net1-2`, you create a job named `job1` and a nested jobnet named `net1-2`.

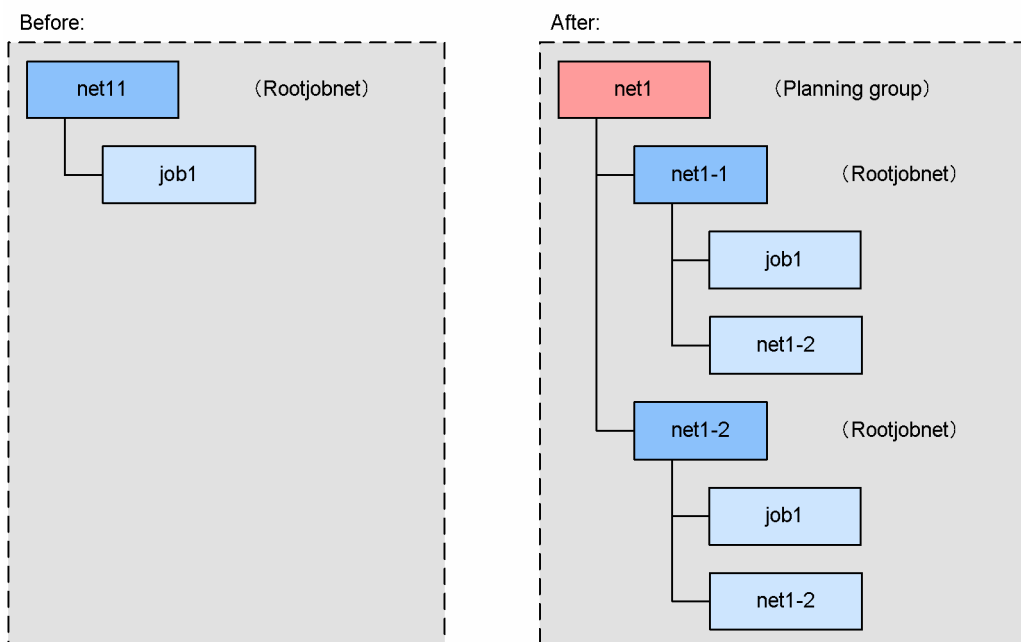

When `yes` is specified for the `-X` option

When specifying a unit name in the command, omit a root jobnet name in a planning group.

This causes the command to automatically select the current unit for operation from the root jobnets in the planning group.

Example: Specifying `/net1` for a unit name

```
ajsplan -h -X yes /net1
```

Explanation:

In this case, the command automatically selects the current unit for operation from `/net1/net1-1` and `/net1/net1-2`.

For units under root jobnets in the planning group, the command selects the current unit for operation from the units having the same path name under a root jobnet.

Example: Specifying `/net1/job1` for a unit name

```
ajsplan -h -X yes /net1/job1
```

Explanation:

In this case, the command automatically selects the current unit for operation from `/net1/net1-1/job1` and `/net1/net1-2/job1`.

When `no` is specified for the `-X` option

Specify a unit name in the planning group without omitting a root jobnet name.

Example: Specifying `/net1/net1-1/job1` for a unit name

```
ajsplan -h -X no /net1/net1-1/job1
```

Explanation:

In this case, the command operates for the specified unit `/net1/net1-1/job1`.

When `auto` is specified for the `-X` option

Whether a target unit will automatically be selected depends on how the unit name is specified.

If you want to automatically select a target unit

The specification format is the same as that used when `yes` is specified for the `-X` option.

If the command cannot find a unit having the path name with a root jobnet name omitted in the planning group, however, it assumes that you specified the unit name without omitting a root jobnet name and operates for the specified unit.

Example 1: Specifying `/net1` for a unit name

```
ajsplan -h -X auto /net1
```

Explanation:

In this case, the command assumes that a unit name is omitted, and automatically selects the current unit for operation from `/net1/net1-1` and `/net1/net1-2`.

Example 2: Specifying `/net1/net1-2` for a unit name

```
ajsplan -h -X auto /net1/net1-2
```

Explanation:

In this case, the command assumes that a unit name is omitted, and automatically selects the current unit for operation from `/net1/net1-1/net1-2` and `/net1/net1-2/net1-2`.

If you want to execute the command for `/net1/net1-2`, specify either of the following:

- Specify `no` for the `-X` option.
- Specify `NO` for the `AJSAUTOJUDGE` environment variable without specifying the `-X` option.

If you do not want to automatically select a target unit

The specification format is the same as that used when `no` is specified for the `-X` option. However, if there is a unit having the same name as the path name specified without the root jobnet name in the planning group, the root jobnet name is assumed to be omitted so that a target unit will be selected automatically.

Example: Specifying `/net1/net1-1` for a unit name

```
ajsplan -h -X auto /net1/net1-1
```

Explanation:

In this case, the command attempts to operate assuming that a unit name is omitted. There is, however, no unit having the unit name without a root jobnet in the planning group, so that the command operates for `/net1/net1-1`.

When `-X` option is not specified

According to the value specified in the `AJSAUTOJUDGE` environment variable, the command determines the target unit in the planning group.

- `AJSAUTOJUDGE` is set to `YES`.
The specification format is the same as that used when `yes` is specified for the `-X` option.
- `AJSAUTOJUDGE` is set to `NO`.
The specification format is the same as that used when `no` is specified for the `-X` option.
- `AJSAUTOJUDGE` is set to `AUTO` or not set
The specification format is the same as that used when `auto` is specified for the `-X` option.
- For details about a planning group, see *11.1 Using a planning group to change the plans for root jobnets* in the manual *JP1/Automatic Job Management System 3 Overview*.

Example 1

The following command temporarily changes the start time of the jobnet `net1` to 17:00.

```
ajsplan -t 17:00 net1
```

Example 2

The following command temporarily stops the unit with wait conditions, `job1` (`/RootJobNet1/job1`), from waiting for the unit whose end is being waited for, `job2` (`/RootJobNet2/job2`).

```
ajsplan -xw disable -xn /RootJobNet2/job2 /RootJobNet1/job1
```

To disable all wait conditions for `job1` (`/RootJobNet1/job1`), execute the command as follows:

```
ajsplan -xw disable -xn * /RootJobNet1/job1
```

ajsplanout

Format

```
ajsplanout
  [-F service-name]
  [-b output-start-date]
  [-d|-c]
  [-R]
  [-E]
  [-T]
  job-name-or-jobnet-name
```

Description

Outputs to the standard output about temporary changes information made to the execution schedule of a root jobnet, or a jobnet or job defined under a root jobnet.

Execution privileges

You must have any of the following JP1 privileges for the root jobnet:

- JP1_AJS_Admin privilege
- JP1_AJS_Manager privilege
- JP1_AJS_Editor privilege
- JP1_AJS_Operator privilege
- JP1_AJS_Guest privilege

Arguments

-F *service-name*

Specify the name of the target scheduler service.

You can specify a character string of 1 to 30 bytes.

-b *output-start-date*

Specify the start date of the range for which you want to output temporary change information, in the format *yyyy/mm/dd*.

You can specify a value in the range from 1994/01/01 to 2099/12/31.

If you omit this option, the command outputs temporary change information for the current date onwards.

-d

Outputs temporary change information.

You cannot specify this option together with the **-c** option.

If you omit both the **-d** and **-c** options, the system assumes the **-d** option.

-c

Outputs temporary change information to the command line.

You cannot specify this option together with the `-d` option.

If you omit both the `-d` and `-c` options, the system assumes the `-d` option.

-R

Outputs temporary change information for all specified units including subordinate units.

If you specify this option together with the `-E` and `-T` options, the command outputs temporary change information according to the specification of each option.

If you do not specify the `-T` option together with the `-R` option, the command applies to all unit types and the output processing of temporary change information ends abnormally for units other than the root jobnet.

-E

Outputs temporary change information for units that have been registered for execution.

-T

Outputs temporary change information for the root jobnet.

job-name-or-jobnet-name

Specify the name of the jobnet for which to output temporary change information, or the name of the job group if specified together with the `-R`, `-E`, or `-T` option.

You can specify a character string of 1 to 930 bytes.

You can specify more than one jobnet name or job group name. However, if you want to specify a jobnet name, you can specify only a root jobnet name. You cannot specify a manager job group name or manager jobnet name.

Notes

- Either of the following users can execute this command:
 - A user granted the reference privilege for the root jobnet to be specified
 - A JP1 user mapped to the OS user who has Administrators or superuser privileges
Note, however, that if `yes` is set after changing the `ADMACLIMIT` environment setting parameter from its default, even a JP1 user who was mapped to an OS user with Administrators or superuser privileges must have the reference privilege.
- If you re-executed a temporary change in the Temporary Changes dialog box of JP1/AJS3 - View, the command does not output the first attempted execution of the temporary change that was later re-executed. It only outputs the temporary change information for the re-execution of the change.

Return values

| | |
|--|--------------|
| 0 | Normal end |
| Multiple of 4 within the range from 4 to 124 | Abnormal end |

Example 1

The following command outputs the temporary change information for generations of root jobnet (`net1`) and its subordinate units scheduled for execution from today to the standard output file.

```
ajsplanout -d /net1
```

Example 2

The following command outputs the temporary change information for generations of root jobnet (`net1`) and its subordinate units scheduled for execution on 2011/08/01 or later to the standard output file.

```
ajsplanout -d -b 2011/08/01 /net1
```

Example 3

The following command outputs the temporary change information for generations of root jobnet (`net1`) and its subordinate units scheduled for execution on 2011/08/01 or later to standard output as an executable command line.

```
ajsplanout -c -b 2011/08/01 /net1
```

Output example 1

The following shows an output example when the `-d` option is specified.

```
(1) Root jobnet = /net
(2) Output time = 2011/10/01 21:45:40
(3)          (4)          (5)  (6)          (7)
Re-executed  Start date   Seq  Operation time  Operation user
(8)
Command
-           2011/10/15  001  2011/10/01 08:20:23  jp1admin
ajsplan -F AJSROOT1 -d 2011/10/15 -t 15:00 -B 20111015001 -X no /net1

Operated     2011/10/15  002  2011/10/01 10:50:10  jp1admin
ajsplan -F AJSROOT1 -p -B 20111015002 -X no /net1/netA

-           2011/10/14  001  2011/10/01 18:00:01  jp1admin
TZ=JST-9 ajsentry -F AJSROOT1 -d 2011/10/14 -t 10:00 /net1

Operated     2011/10/11  001  2011/10/01 20:45:40  jp1admin
ajsplan -F AJSROOT1 -p -B 20111011001 -X no /net1
```

Explanation of the output items

- When temporary change information exists for the target root jobnet
Outputs lines (1) to (8).
If more than one piece of temporary change information is associated with the root jobnet, the command repeats lines (3) to (8) without the title portion.
- When no temporary change information exists for the target root jobnet
Outputs lines (1) and (2) and the message KAVS4670-I before terminating abnormally.

(1) Root jobnet

The full path name of the root jobnet whose temporary change information is being output.

(2) Output time

The date and time when the `ajsplanout` command output the temporary change information (according to the locale setting of the scheduler service), in the format `YYYY/MM/DD HH:MM:SS`.

(3) Re-executed

Outputs `Operated` if the temporary change has been re-executed.

This field displays a hyphen (-) if the temporary change has not been re-executed.

(4) Start date

Outputs the scheduled start date component (`YYYYMMDD`) of the execution registration number (`YYYYMMDDNNN`) in the format `YYYY/MM/DD`.

Single-digit `MM` or `DD` values are prefixed with 0 (for example: `2012/01/01`). `****/**/**` appears in this field if you used the `-d` or `-t` option of the `ajsentry` command to add an execution date, or added a fixed execution schedule in the Daily Schedule or Monthly Schedule window.

(5) Seq

Outputs the sequence number component (`NNN`) of the execution registration number (`YYYYMMDDNNN`)

`***` appears in this field if you used the `-d` or `-t` option of the `ajsentry` command to add an execution date, or added a fixed execution schedule in the Daily Schedule or Monthly Schedule window.

(6) Operation time

Outputs the date and time when the temporary change was executed in the format `YYYY/MM/DD HH:MM:SS`.

(7) Operation user

Outputs the name of the user who executed the temporary change.

(8) Command

Outputs executed temporary changes as an executable command line.

Lines for temporary changes that were scheduled for execution with a `TZ` environment variable set are prefixed with the value of the `TZ` environment variable.

Depending on the target environment, you might not be able to execute the command line as output. In this case, modify the command line to suit the target environment.

Output example 2

The following shows an output example when the `-c` option is specified.

```
Output time = 2011/10/01 21:45:40
ajsplan -F AJSROOT1 -d 2011/10/15 -t 15:00 -B 20111015001 -X no /net1
ajsplan -F AJSROOT1 -p -B 20111015002 -X no /net1/netA
TZ=JST-9 ajsentry -F AJSROOT1 -d 2011/10/14 -t 10:00 /net1
ajsplan -F AJSROOT1 -p -B 20111011001 -X no /net1
```

Explanation of the output items

The command outputs the date and time the temporary change information were output, and details of each temporary change in the form of an executable command line. For a description of the contents of the Output time and Command fields, see items (2) and (8) in output example 1.

This command does not output the root jobnet name or the title row. If no temporary change information exists for the root jobnet, the command outputs the Output time field and the message KAVS4670-I before terminating abnormally.

ajsprint

Format

```
ajsprint
  [-F service-name]
  {-a|-c year[/month[/day]]|-d|-f format-indicator|-v}
  [-t format-indicator]
  [-s {yes|no}]
  [-J|-N|-G]
  [-R]
  [-L|-E]
  [-T]
  job-name-or-jobnet-name-or-job-group-name...
```

Description

Outputs definitions of a unit to the standard output file.

Execution privileges

You must have any of the following JP1 privileges:

- JP1_AJS_Admin privilege
- JP1_AJS_Manager privilege
- JP1_AJS_Editor privilege
- JP1_AJS_Operator privilege
- JP1_AJS_Guest privilege

Arguments

-F *service-name*

Specify the name of the target scheduler service.

You can specify a character string of 1 to 30 bytes.

-a

Specify this option to output the unit definition information of the specified unit and its subordinate units in the format available for the `ajsdefine` command.

With this option specified, you cannot specify the root job group "/" as its argument.

You cannot specify this option with the `-t` option.

You can use the `AJSPRINTNETSCHPRF` environment setting parameter to specify either of the following output formats when outputting unit definition information for a nested jobnet having a schedule rule with a specification depending on the schedule for the upper-level jobnet:

- Enable the schedule rule and do not depend on the schedule for the upper-level jobnet.
- Delete the schedule rule and depend on the schedule for the upper-level jobnet.

For details about how to set the `AJSPRINTNETSCHPRF` environment setting parameter, see 20.4.2(79) *AJSPRINTNETSCHPRF* in the *JPI/Automatic Job Management System 3 Configuration Guide*.

-c *year*[/*month*[/*day*]

Specify the date when you want to output calendar information (open or closed day).

You can specify this option with the `-t` option, but cannot specify it with the `-J`, `-N`, `-L`, `-E`, or `-T` option.

- *year*
You can specify a value between 1994 and 2099 for the year.
- *month*
You can specify value between 1 and 12 for the month.
- *day*
You can specify a value between 1 and 31 for the day.

You can select one of the following output formats. (Also see *Example 1* later.)

- *year/month/day*
Outputs calendar information on that day.
- *year/month*
Outputs calendar information on one month after the base date[#].
- *year*
Outputs calendar information on the 12 months from the base date[#] for each of January to December.

#

You can use the `ajscalendar` command to specify the base date.

If you specify this option, you can specify only a job group name as the argument for the unit. (If you specify a job or jobnet name, no characters are output.)

If you define a job group under another job group, the calendar information of the job group you defined and the calendar information of all upper-level job groups are merged, as shown in the example below.

Example:

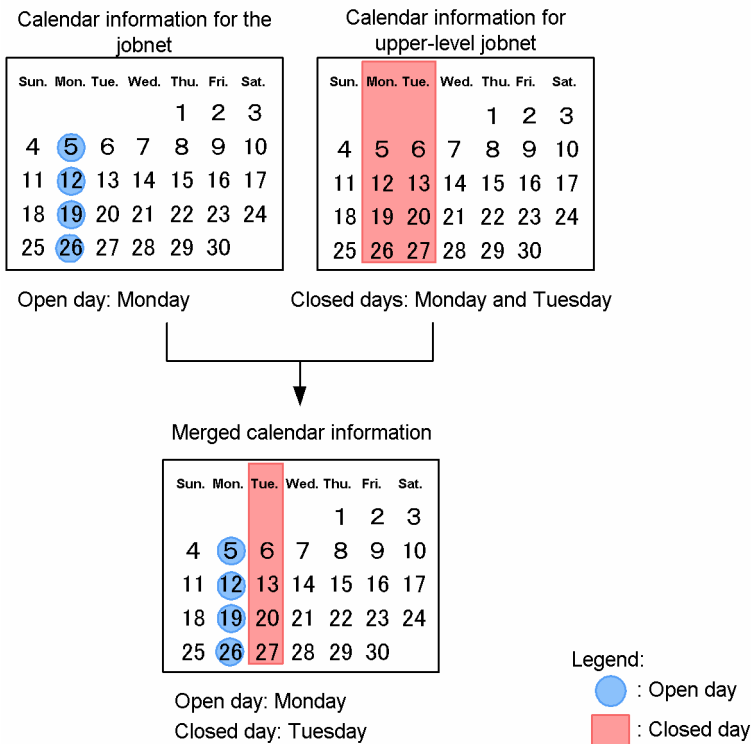

-d

Outputs the calendar information parameter needed to deliver calendar information.

If you specify this option, you can specify only a job group name as the argument for the unit. (If you specify a job or jobnet name, no characters are output.) You can specify the root job group "/" as well.

Output information is the unit definition parameters for the open and closed days. By outputting the information in a file, you can specify the file as the calendar information file in the `-df` option in the `ajscalendar` command. For details about their format, see [5.1 Creating a unit definition file](#).

You cannot specify this option with the `-J`, `-N`, `-L`, `-E`, `-T` or `-t` option.

-f format-indicator

Outputs the information specified by the format indicator.

Specify the format indicator by `%` followed by a one- or two-byte string of alphabetic characters. For details about the format indicator, see [Additional information](#) later.

Characters are output as specified, except for the format indicator enclosed in double quotation marks (").

You can specify this option with the `-t` option.

-v

Searches for units that are placed in a particular directory and are using macro variables. The option thus outputs three items of information about such units, if any, in list form. The information refers to the full name of the unit, the definition item name (the unit definition parameter name), and the macro variable name in the definition information. The three items of information correspond to a single line of output data. If two or more of the same item are found, there will be as many outputs as there are lines. Even when one definition item in a single unit has several macro variables defined, one line of data is divided and output on several lines.

The output format is shown below (also see [Example 3](#) later in this section):

- *information-1 information-2 information-3*
information-1: Full name of the unit
information-2: Unit definition parameter name
information-3: Macro variable name in the definition information

These items of information are separated by single-byte spaces before they are output.

If the units under the particular directory have no units using macro variables, then nothing is output and the command terminates normally.

You cannot specify this option together with the `-a`, `-c`, `-d`, `-f`, or `-t` option.

-t *format-indicator*

Outputs the information specified by the format indicator to the title row.

Specify the format indicator by % followed by a one- or two-byte string of alphabetic characters. For details about the format indicator, see [Additional information](#) later.

Characters are output as specified, except for the format indicator enclosed in double quotation marks (").

You can specify this option with the `-c` and `-f` options, but cannot specify this option with the `-a` option.

-s {*yes* | *no*}

Specifies whether to fix the order of relation line information entries that are output in unit definition information when the `-f` or `-a` option is specified. If the `-f` option is specified, each entry of relation line information is output as a value represented by the `%ar` format indicator. If you specified the `-a` option, each entry of relation line information is output as the `ar` parameter.

- *yes*
Fixes the output order of relation line information entries for units. The following rules apply when relation line information entries are output:
 1. Entries are output in ascending order of the character codes of the preceding unit names.
 2. If the preceding units are the same, entries are output in ascending order of character codes of the succeeding unit names.
- *no*
Does not fix the output order of relation line information entries for units. The output order of relation line entries depends on the unit creation order.

If you omit this option, the value specified for the `AJSPRINTSORTUNITINF` environment setting parameter (*yes* or *no*) is used for operation. If you omit both the `-s` option and the `AJSPRINTSORTUNITINF` environment setting parameter, *no* is assumed.

If the values of the `-s` option and the `AJSPRINTSORTUNITINF` environment setting parameter are different, the `-s` option takes precedence over the parameter.

For details about how to set the `AJSPRINTSORTUNITINF` environment setting parameter, see [20.4.2\(109\) AJSPRINTSORTUNITINF](#) in the *JPI/Automatic Job Management System 3 Configuration Guide*.

Use the `-s yes` option to compare definition information of two units when, for example, you migrate an environment or customize a defined unit as shown below:

- In the environment before migration, execute the `ajsprint` command to output unit definition information. Then, in the environment after migration, execute the `ajsdefine` command to import the unit definition information.
- Create a jobnet by executing a defined jobnet, and then customize the definition of the original jobnet.

To compare information as shown above, specify `yes` for the `-s` option to output definition information. Thus, relation line information entries are output in alphabetical order of unit name for the original jobnet, its copy, and a new jobnet created by the `ajsdefine` command. This prevents unintended differences from being generated.

For examples of using the `-s` option, see [Example 4](#) later and [13.1.8 Editing units defined by JP1/AJS3 - View and comparing definitions before and after editing](#) in the *JP1/Automatic Job Management System 3 Administration Guide*.

-J

Outputs job definitions.

You cannot specify this option with the `-c`, `-d`, or `-T` option.

-N

Outputs jobnet definitions.

You cannot specify this option with the `-c` or `-d` option.

-G

Outputs job group definitions.

You cannot specify this option with the `-L`, `-E`, and/or `-T` option.

-R

Outputs the definitions of all the job groups, jobnets, and jobs contained in the specified unit. The items are output repeatedly on a layer-by-layer basis.

If you specify this option with the `-L`, `-E`, and/or `-T` options, the system outputs the definitions of the unit according to the specification of each option.

It is recommended that you avoid specifying this option together with the `-a` option. If you specify this option together with the `-a` option, an attempt to specify the output result in the unit definition information in the `ajsdefine` command may fail to define the unit correctly.

-L

Outputs definitions of a jobnet not registered for execution.

You cannot specify this option with the `-c`, `-d`, or `-G` option.

-E

Outputs definitions of a jobnet registered for execution.

You cannot specify this option with the `-c`, `-d`, or `-G` option.

-T

Outputs definitions of the root jobnet.

You cannot specify this option with the `-c`, `-d`, `-J`, or `-G` option.

job-name-or-jobnet-name-or-job-group-name

Specify the name of the job, jobnet, or job group that you want to output definitions.

You can specify a character string of 1 to 930 bytes.

You can specify more than one job, jobnet, or job group names. If you set the `-c` and `-d` options, however, you can specify only a job group name.

With the `-a` option specified, you cannot specify the root job group `"/` as its argument.

With the `-d` option specified, you can specify the root job group `"/` as its argument.

You can specify a logical host name as a job, jobnet or job group name. You cannot specify an execution ID.

Notes

- Either of the following users can output the unit definition:
 - A user granted the reference privilege when the unit whose definition is output was defined or when its attributes were changed
 - A JP1 user mapped to the OS user who has Administrators or superuser privilegesNote, however, that if `yes` is set after changing the `ADMACLIMIT` environment setting parameter from its default, even a JP1 user who was mapped to an OS user with Administrators or superuser privileges must have the reference privilege.
- When you specify the `-a` option to output the unit definition information in the unit, if the defined content is equal to the default value of a parameter, the parameter is not output. If the parameter is not output, then its default value is defined as in the table below. For details about individual parameters, see [5.2 Definition format and parameters](#).

Table 3–12: Parameter default values

| Unit type | Parameter | Default value |
|-----------------|-----------|---------------|
| Job group | Gty | n |
| Jobnet | Wt | N, no |
| | Wc | N, no |
| | Cftd | N, no |
| | Rg | 1 |
| | Ha | n |
| | Cd | no |
| | De | y |
| | Ms | sch |
| | Mp | n |
| | Mm | and |
| | Nmg | n |
| | Ega | none |
| Uem | n | |
| start condition | Ab | exec |

| Unit type | Parameter | Default value |
|---------------------|-----------|---------------|
| start condition | Mcs | m |
| | Cgs | y |
| UNIX/PC job | Soa | new |
| | Sea | new |
| | Jd | cod |
| | Abr | n |
| | Ha | n |
| | Eu | ent |
| | Jty | q |
| | Mm | and |
| | Nmg | n |
| | Ega | none |
| | Uem | n |
| Queue job | Jd | cod |
| | Abr | n |
| | Ha | n |
| | Eu | ent |
| | Mm | and |
| | Nmg | n |
| | Ega | none |
| | Uem | n |
| Judgment job | Ej | gt |
| | Ejm | ge |
| | Eju | le |
| Flexible job | Jd | cod |
| | Abr | n |
| | Ha | n |
| | Eu | ent |
| | Mm | and |
| | Nmg | n |
| | Ega | none |
| | Uem | n |
| HTTP Connection job | Htknd | GET |
| | Htspt | diff |
| | Jd | cod |

| Unit type | Parameter | Default value |
|------------------------------------|-----------|---------------|
| HTTP Connection job | Abr | n |
| | Ha | n |
| | Eu | def |
| | Mm | and |
| | Nmg | n |
| | Ega | none |
| | Uem | n |
| JP1 event reception-monitoring job | Evtmc | n |
| | Ha | n |
| | Eu | ent |
| | Evesc | no |
| | Ets | kl |
| | Mm | and |
| | Nmg | n |
| | Ega | none |
| | Uem | n |
| File monitoring job | Flwc | c |
| | Flwi | 60 |
| | Flco | n |
| | Ha | n |
| | Eu | ent |
| | Ets | kl |
| | Mm | and |
| | nmg | n |
| | ega | none |
| | uem | n |
| Email reception-monitoring job | pfm | p |
| | mlsav | y |
| | ha | n |
| | eu | ent |
| | ets | kl |
| | mm | and |
| | nmg | n |
| | ega | none |
| uem | n | |

| Unit type | Parameter | Default value |
|--|-----------|---------------|
| Message queue reception-monitoring job | ha | n |
| | eu | ent |
| | ets | kl |
| | mm | and |
| | nmg | n |
| | ega | none |
| | uem | n |
| MSMQ reception-monitoring job | ha | n |
| | eu | ent |
| | ets | kl |
| | mm | and |
| | nmg | n |
| | ega | none |
| | uem | n |
| Log file monitoring job | lfdft | s |
| | lfsrc | n |
| | lfcrc | n |
| | ha | n |
| | eu | ent |
| | ets | kl |
| | mm | and |
| | nmg | n |
| | ega | none |
| | uem | n |
| Windows event log monitoring job | ntnsr | y |
| | ntncl | y |
| | ntnei | y |
| | ha | n |
| | eu | ent |
| | ets | kl |
| | mm | and |
| | nmg | n |
| | ega | none |
| | uem | n |
| Execution interval control job | etn | n |

| Unit type | Parameter | Default value |
|--------------------------------|-----------|---------------|
| Execution interval control job | ha | n |
| | eu | ent |
| | ets | kl |
| | mm | and |
| | nmg | n |
| | ega | none |
| | uem | n |
| JP1 event sending job | pfm | p |
| | ha | n |
| | eu | ent |
| | evsrt | n |
| | evspl | 10 |
| | evsrc | 0 |
| | jty | q |
| | mm | and |
| | nmg | n |
| | ega | none |
| | uem | n |
| Email sending job | pfm | p |
| | ha | n |
| | eu | ent |
| | jty | q |
| | mm | and |
| | nmg | n |
| | ega | none |
| uem | n | |
| Message queue sending job | mqprm | n |
| | pfm | p |
| | ha | n |
| | eu | ent |
| | jty | q |
| | mm | and |
| | nmg | n |
| | ega | none |
| uem | n | |

| Unit type | Parameter | Default value |
|----------------------------|-----------|---------------|
| MSMQ sending job | msmod | h |
| | msjnl | n |
| | msunr | n |
| | ha | n |
| | eu | ent |
| | jty | q |
| | mm | and |
| | nmg | n |
| | ega | none |
| | uem | n |
| OpenView status report job | cmsts | un |
| | pfm | p |
| | ha | n |
| | eu | ent |
| | jty | q |
| | mm | and |
| | nmg | n |
| | ega | none |
| | uem | n |
| Local power control job | pwl t | f |
| | pwl f | f |
| | pfm | p |
| | ha | n |
| | eu | ent |
| | jty | q |
| | mm | and |
| | nmg | n |
| | ega | none |
| | uem | n |
| Remote power control job | pwrn | a |
| | pwrr | n |
| | pwrw | n |
| | pwrp | p |
| | pfm | p |
| | ha | n |

| Unit type | Parameter | Default value |
|--------------------------|------------------|---------------|
| Remote power control job | eu | ent |
| | jty | q |
| | mm | and |
| | nmg | n |
| | ega | none |
| | uem | n |
| Custom UNIX/PC job | jd | cod |
| | abr | n |
| | ha | n |
| | eu | ent |
| | soa | new |
| | sea | new |
| | mm | and |
| | nmg | n |
| | ega | none |
| | uem | n |
| | Jobnet connector | mm |
| nmg | | n |
| ega | | none |
| uem | | n |
| custom event job | ha | n |
| | eu | ent |
| | ets | kl |
| | mm | and |
| | nmg | n |
| | ega | none |
| | uem | n |

- If the command is executed for a release target jobnet (root jobnet for which release entry is made), only the jobnet definitions in *Being applied* status are output.

Arguments that can be specified when executing the command from JP1/AJS3 - View

You can specify the following arguments when executing the `ajsprint` command from JP1/AJS3 - View:

| No. | Arguments | Required? |
|-----|------------------------------|-----------|
| 1 | <code>-F service-name</code> | Y |
| 2 | <code>-a</code> | -- |

| No. | Arguments | Required? |
|-----|--|-----------|
| 3 | -c <i>year[/month[/day]]</i> | -- |
| 4 | -d | -- |
| 5 | -f <i>format-indicator</i> | -- |
| 6 | -v | -- |
| 7 | -s {yes no} | -- |
| 8 | -t <i>format-indicator</i> | -- |
| 9 | -J | -- |
| 10 | -N | -- |
| 11 | -G | -- |
| 12 | -R | -- |
| 13 | -L | -- |
| 14 | -E | -- |
| 15 | -T | -- |
| 16 | <i>job-name-or-jobnet-name-or-job-group-name</i> | Y |

Legend:

Y: Required

--: Optional

You cannot specify any other options when executing the `ajsprint` command from JP1/AJS3 - View.

For details about how to execute JP1/AJS3 commands from JP1/AJS3 - View, see *10.4 Executing JP1/AJS3 commands from JP1/AJS3 - View* in the *JP1/Automatic Job Management System 3 Operator's Guide*.

Return values

| | |
|--|--------------|
| 0 | Normal end |
| Multiple of 4 within the range from 4 to 124 | Abnormal end |

Additional information

- This section describes how to migrate information (job groups, jobnets, jobs, calendar information, etc.) specified on one server ("Server A") to another ("Server B"), as well as an example in which the command is actually used. You can use this procedure when information defined on a development server is migrated to a server for actual operation.

- Execute the `ajsprint` command on Server A and output (save) the definition information to a file.

```
ajsprint */** > temporary-file-name
```

- Execute the `ajsdefine` command on Server B and recover the information saved in step 1.

```
ajsdefine -d / temporary-file-name
```

Cautionary note

With this method, you cannot save or recover the calendar information and other items defined in root job groups. This procedure is mentioned later in [Example 2](#).

- *Table 3-13* lists the format indicators to output definitions of units. You can set all the format indicators listed in the table for the `-f` option. For the `-t` option, you can set only the format indicators with a superscript (^{#1}).

Depending on the unit type, there are restrictions for which you can specify format indicators. If you specify a format identifier that cannot be specified for a unit type, the information corresponding to the format identifier is not output. Abbreviations are used to specify which format indicators are applicable to which unit types. For these abbreviations, see the `ty` parameter in *5.2.1 Attribute definition*.

Table 3-14 lists the other format indicators.

Table 3-15 provides the output formats of the format indicators.

Table 3-16 lists the indications of the permission mode.

Table 3–13: Format indicators for unit output

| Format indicator | Output information | Unit type abbreviations ^{#3} |
|-------------------------------|--|---|
| <code>%JN^{#1}</code> | Full name of a unit Character string of up to 930 bytes | mg, g, mn, rc, n, rm, j, pj, qj, jdj, cj, cpj, orj, cmsj, evsj, evwj, flwj, lfwj, mlsj, mlwj, mqsj, mqwj, mssj, mswj, ntwj, pwlj, pwrj, tmwj, nc, fxj, htpj, cewj |
| <code>%jn^{#1}</code> | unit-name Character string of up to 30 bytes | mg, g, mn, rc, n, rm, j, pj, qj, jdj, cj, cpj, orj, cmsj, evsj, evwj, flwj, lfwj, mlsj, mlwj, mqsj, mqwj, mssj, mswj, ntwj, pwlj, pwrj, tmwj, nc, fxj, htpj, cewj |
| <code>%ap^{#1}</code> | Character string set for <code>AJSCONF=</code> or <code>AJSPATH=</code> Character string specified with <code>%JN</code> except the part that follows the right-most slash (/) | mg, g, mn, rc, n, rm, j, pj, qj, jdj, cj, cpj, orj, cmsj, evsj, evwj, flwj, lfwj, mlsj, mlwj, mqsj, mqwj, mssj, mswj, ntwj, pwlj, pwrj, tmwj, nc, fxj, htpj, cewj |
| <code>%TY^{#1}</code> | Unit type mgroup: Manager job group group: Job group mnet: Manager jobnet condn: Start condition (.CONDITION) net: Jobnet rnet: Jobnet for recovery rmnet: Remote jobnet rnet: Remote jobnet for recovery job: Unix job rjob: Unix job for recovery pjob: PC job rpjob: PC job for recovery qjob: QUEUE job rqjob: QUEUE job for recovery jdjob: Judgment job rjdjob: Judgment job for recovery orjob: OR job rorjob: OR job for recovery fxjob: Flexible job rfxjob: Flexible job for recovery htpjb: HTTP Connection job rhtpjb: HTTP Connection job for recovery cmsjb: OpenView status report job rcmsjb: OpenView status report job for recovery | mg, g, mn, rc, n, rm, j, pj, qj, jdj, cj, cpj, orj, cmsj, evsj, evwj, flwj, lfwj, mlsj, mlwj, mqsj, mqwj, mssj, mswj, ntwj, pwlj, pwrj, tmwj, nc, fxj, htpj, cewj |

| Format indicator | Output information | Unit type abbreviations ^{#3} |
|------------------|---|---|
| %TY#1 | evwjb: JP1 event reception monitoring job revwjb: JP1 event reception monitoring job for recovery flwjb: File monitoring job rflwjb: File monitoring job for recovery mlwjb: Email reception monitoring job rmlwjb: Email reception monitoring job for recovery mqwjb: Message queue reception monitoring job rmqwjb: Message queue reception monitoring job for recovery mswjb: MSMQ reception monitoring job rmswjb: MSMQ reception monitoring job for recovery lfwjb: Log file monitoring job rflwjb: Log file monitoring job for recovery ntwjb: Windows event-log monitoring job rntwjb: Windows event-log monitoring job for recovery tmwjb: Execution interval control job rtmwjb: Execution interval control job for recovery cewjb: Custom event job rcewjb: Custom event job for recovery evsjb: JP1 event sending job revsjb: JP1 event sending job for recovery mlsjb: Email sending job rmlsjb: Email sending job for recovery mqsjb: Message queue sending job rmqsjb: Message queue sending job for recovery mssjb: MSMQ sending job rmssjb: MSMQ sending job for recovery pwljb: Local power control job rpwljb: Local power control job for recovery pwrjb: Remote power control job rpwrjb: Remote power control job for recovery cuujb: Custom Unix job rcuujb: Custom Unix job for recovery cupjb: Custom PC job rcupjb: Custom PC job for recovery netcn: Jobnet connector | mg, g, mn, rc, n, rm, j, pj, qj, jdj, cj, cpj, orj, cmsj, evsj, evwj, flwj, lfwj, mlsj, mlwj, mqsj, mqwj, mssj, mswj, ntwj, pwlj, pwrj, tmwj, nc, fxj, htpj, cewj |
| %ow#1 | Owner name Character string of up to 31 bytes. By default, no characters are output. | mg, g, mn, rc, n, rm, j, pj, qj, jdj, cj, cpj, orj, cmsj, evsj, evwj, flwj, lfwj, mlsj, mlwj, mqsj, mqwj, mssj, mswj, ntwj, pwlj, pwrj, tmwj, nc, fxj, htpj, cewj |
| %gr#1 | JP1-resource-group-name Character string of up to 63 bytes. By default, no characters are output. | mg, g, mn, rc, n, rm, j, pj, qj, jdj, cj, cpj, orj, cmsj, evsj, evwj, flwj, lfwj, mlsj, mlwj, mqsj, mqwj, mssj, mswj, ntwj, pwlj, pwrj, tmwj, nc, fxj, htpj, cewj |
| %ud#1 | Last updated time ^{#2} | mg, g, mn, rc, n, rm, j, pj, qj, jdj, cj, cpj, orj, cmsj, evsj, evwj, flwj, lfwj, mlsj, mlwj, mqsj, mqwj, mssj, mswj, ntwj, pwlj, pwrj, tmwj, nc, fxj, htpj, cewj |
| %cm | Comment Character string of up to 80 bytes. By default, no characters are output. | mg, g, mn, rc, n, rm, j, pj, qj, jdj, cj, cpj, cmsj, evsj, evwj, flwj, |

| Format indicator | Output information | Unit type abbreviations ^{#3} |
|------------------|---|---|
| %cm | Comment Character string of up to 80 bytes. By default, no characters are output. | lfwj, mlsj, mlwj, mqsj, mqwj, mssj, mswj, ntwj, pwlj, pwrj, tmwj, nc, fxj, htpj, cewj |
| %mh | Manager host name Character string of up to 255 bytes. By default, no characters are output. | mg, mn |
| %mu | Manager unit name Character string of up to 961 bytes. By default, no characters are output. | mg, mn |
| %en | Name of a unit contained in the specified unit Character string of up to 30 bytes | g, rc, n, rm |
| %eN | Unit name enclosed by type symbols contained in the specified unit Character string of 35 or fewer bytes. The enclosing symbols indicate the type of each unit. <job-group-name> (jobnet-name) (remote-jobnet-name) R [Unix-job-name] <manager-job-group-name>M (manager-jobnet-name) M {QUEUE-job-name} [PC-job-name] P !name-of-the-jobnet-with-start-conditions! [judgment-job-name] J [OR-job-name] O [JP1-event-reception-monitoring-job-name] E [file-monitoring-job-name] F [Email-reception-monitoring-job-name] M [message-queue-reception-monitoring-job-name] Q [MSMQ-reception-monitoring-job-name] S [log-file-monitoring-job-name] L [Windows-event-log-monitoring-job-name] N [execution-interval-control-job-name] T [JP1-event-sending-job-name] e [Email-sending-job-name] m [message-queue-sending-job-name] q [MSMQ-sending-job-name] s [OpenView-status-report-job-name] C [local-power-control-job-name] W [remote-power-control-job-name] w [custom-Unix-job-name] U [custom-PC-job-name] u (jobnet-connector-name) C [flexible-job] c [HTTP-connection-job] H In the case of a recovery unit, enclosing symbols are doubled. Example: [[Unix-job-for-recovery-name]] | g, rc, n, rm |
| %Ce | Whether to enable linkage of root jobnet execution order control between scheduler services | g, n, nc |

| Format indicator | Output information | Unit type abbreviations ^{#3} |
|------------------|---|---------------------------------------|
| %Ce | y: Linkage between scheduler services is enabled. n: Linkage between scheduler services is disabled. | g, n, nc |
| %Ch | Connection host name Character string of no more than 255 bytes. By default, no characters are output. | g, n, nc |
| %Cs | Connection service name Character string of no more than 30 bytes. By default, no characters are output. | g, n, nc |
| %et | Type of a unit contained in the specified unit See %TY. | g, rc, n, rm |
| %eH | Horizontal display position of a unit contained in the specified unit 0 to 16,000 pixels | g, rc, n, rm |
| %eV | Vertical display position of a unit contained in the specified unit 0 to 10,000 pixels | g, rc, n, rm |
| %sH | How many units contained in the specified unit are to be displayed horizontally 1 to 100 | g, rc, n, rm |
| %sV | How many units contained in the specified unit are to be displayed vertically 1 to 100 | g, rc, n, rm |
| %oP | Open day (Specify a particular day.) ^{#2} | G |
| %c1 | Closed day (Specify a particular day.) ^{#2} | G |
| %w0 to %w6 | Standard-week value %w0: Sunday %w1: Monday %w2: Tuesday %w3: Wednesday %w4: Thursday %w5: Friday %w6: Saturday o: Open day x: Closed day -: None | G |
| %sd | Base date 1 to 31: day xx: n: Day of the week (xx is su, mo, tu, we, th, fr or sa) and week (n is 1 to 5) None | G |
| %md | Base month this: Current month next: Next month -: None | G |
| %st | Base time hh:mm : Hours (hh is 0 to 23 hours, and mm is 0 to 59 minutes.) **:**: None | G |
| %Sd | Date when the jobnet execution is started ^{#2} | n, rm |
| %St | Time when the jobnet execution is started ^{#2} | n, rm |
| %sY | Time when the jobnet start is delayed ^{#2} | n, rm |

| Format indicator | Output information | Unit type abbreviations ^{#3} |
|------------------|--|---------------------------------------|
| %ey | Time when the jobnet end is delayed ^{#2} | n, rm |
| %ln | Link number <i>N, n</i> : <i>N</i> indicates a rule number (1 to 144) when multiple schedules are defined. <i>n</i> indicates a link number (1 to 144). Nothing is output if the rule number is the same as the link number. -,-: None (The related jobnet does not have any link number to be output). | n, rm |
| %cy | Processing cycle <i>N, n, X</i> : <i>N</i> indicates a rule number when multiple schedules are defined (1 to 144). <i>n</i> is the value corresponding to <i>X</i> , being 1 to 31 (year, month, week or day). <i>X</i> indicates the type of a processing cycle, being <i>y</i> , <i>m</i> , <i>w</i> or <i>d</i> . <i>n, y</i> : Year (<i>n</i> is 1 to 9.) <i>n, m</i> : Month (<i>n</i> is 1 to 12.) <i>n, w</i> : Week (<i>n</i> is 1 to 5.) <i>n, d</i> : Day (<i>n</i> is 1 to 31.) -,-,-: None | n, rm |
| %sh | Method of substitution <i>N, XXXX</i> : <i>N</i> indicates a rule number when multiple schedules are defined (1 to 144). <i>XXXX</i> indicates the method of substitution, being <i>before</i> , <i>after</i> , <i>cancel</i> or <i>none</i> . <i>before</i> : Execute on the previous day <i>after</i> : Execute on the next day <i>cancel</i> : Do not execute <i>none</i> : Execute without shift | n, rm |
| %hd | Maximum number of shift days <i>N, XX</i> : <i>N</i> indicates a rule number when multiple schedules are defined (1 to 144). <i>XX</i> indicates the maximum number of shift days, being 1 to 31. | n, rm |
| %Wt | Waiting time for an event <i>{N, t, HH:MM N, r, MMMM N, u N, -}</i> : <i>N</i> indicates a rule number when multiple schedules are defined (1 to 144). <i>t</i> , <i>r</i> , <i>u</i> and <i>-</i> provide the types of waiting time for an event. <i>HH:MM</i> (<i>HH</i> is hours of 0 to 47, and <i>MM</i> is minutes of 0 to 59) and <i>MMMM</i> (1 to 2,879 minutes) provide waiting time for an event. <i>t</i> : Absolute time <i>r</i> : Relative minutes <i>u</i> : Unlimited -: None | n, rm |
| %Wc | Number of times the event is awaited <i>{N, w, n N, u N, -}</i> : <i>N</i> indicates a rule number when multiple schedules are defined (1 to 144). <i>w</i> , <i>n</i> , <i>u</i> and <i>-</i> provide the types of the number of times the event is awaited. <i>n</i> indicates the number of times the event is awaited (0 to 999). <i>w</i> : Specifies the number of events to be awaited. <i>u</i> : Specifies an unlimited number of times for waiting. -: None | n, rm |
| %Cf | Shift information <i>{N, m, C -, c -}</i> : <i>N</i> indicates a rule number when multiple schedules are defined (1 to 144). <i>m</i> indicates a shift type, being <i>a</i> , <i>b</i> , <i>db</i> , <i>da</i> , or <i>n</i> . <i>C</i> indicates shift days, being 1 to 31. <i>c</i> indicates the maximum number of shift days, being 1 to 31. <i>-</i> means none. | n, rm |

| Format indicator | Output information | Unit type abbreviations ^{#3} |
|------------------|--|---|
| %Cf | If <i>m</i> is n, - is output in place of <i>C</i> or <i>c</i> . If <i>m</i> is db or da, - is output in place of <i>c</i> . b: Execute on an open day preceding the previous day. a: Execute on an open day following the next day. db: Execute on a day preceding the previous day. da: Execute on an open day following the next day. n: None | n, rm |
| %Ej | Name of a jobnet not to be executed concurrently Character string of up to 30 bytes. By default, no characters are output. | n, rm |
| %ed | Term until the jobnet can be executed ^{#2} | n, rm |
| %rg | Number of logs to keep 1 to 99 You can, however, enable the system setting option to output up to 999 generations. | n, rm |
| %Ni | Execution priority of a jobnet 1 to 5. The default is -. | n, rm |
| %jc | Calendar information Character string of up to 930 bytes. By default, no characters are output. | n, rm |
| %cd | Time-out period for waiting for an event 1day: Waits for one day. 2day: Waits for two days. unlimited: Waits without any limit. -: None | n, rm |
| %de | Dependence on the schedule of the upper-level jobnet yes: Depends. no: Does not depend. | n, rm |
| %ms | Schedule option skip: Schedule skip muti: Multi-schedule | n, rm |
| %mp | Concurrent execution attribute yes: Permitted no: Not permitted | n, rm |
| %ha | Hold attribute yes: Holds no: Does not hold ifAbend: Hold if the previous state was abend ifAbendW: Hold if the previous state was warning | n, rm, j, pj, qj, jdj, cj, cpj, cmsj, evsj, evwj, flwj, lfwj, mlsj, mlwj, mqsj, mqwj, mssj, mswj, ntwj, pwlj, pwrj, tmwj, fxj, htpj, cewj |
| %Rh | Name of the execution manager defined for the remote jobnet Character string of up to 255 bytes. By default, no characters are output. | Rm |
| %ar | Order in which units are executed <i>preceding-unit-name, succeeding-unit-name, connection-type</i> Specify the name of a unit name. Use a character string of up to 30 bytes. The connection type is <i>s</i> or <i>c</i> . The default is -,-. <i>s</i> : Sequential connection <i>c</i> : Conditional connection | n, rm |
| %CO | Start condition | Rc |

| Format indicator | Output information | Unit type abbreviations ^{#3} |
|------------------|--|--|
| %CO | and: AND or: OR | Rc |
| %eU | JP1 user for job execution ent: User who registered the job def: User who defined the job | j, pj, qj, cj, cpj, cmsj, evsj, evwj, flwj, lfwj, mlsj, mlwj, mqsj, mqwj, mssj, mswj, ntwj, plwj, pwrj, tmwj, fxj, htpj, cewj |
| %cn | Custom job name Character string of up to 16 bytes. By default, no characters are output. | cj, cpj |
| %Te | Command text Character string of up to 1,023 bytes. By default, no characters are output. | j, cj, cpj |
| %sc | Script file name (for UNIX), or target file name (for Windows) Character string of up to 511 bytes. By default, no characters are output. | j, pj, qj, cj, cpj, fxj |
| %pm | Parameter Character string of up to 1,023 bytes. By default, no characters are output. | j, pj, qj, cj, cpj, fxj |
| %wk | Work path name Character string of up to 511 bytes. By default, no characters are output. | j, pj |
| %ev | Environment variable file name Character string of up to 511 bytes. By default, no characters are output. | j, pj |
| %En | Environment variable Character string of up to 20,479 bytes. By default, no characters are output. If multiple environment variables are specified, they are output delimited by a semicolon (;). | j, pj, cj, cpj, fxj |
| %si | Standard input file name Character string of up to 511 bytes. By default, no characters are output. | j, pj |
| %so | Standard output file name Character string of up to 511 bytes. By default, no characters are output. | j, pj, cj, cpj, htpj |
| %se | Standard error output file name Character string of up to 511 bytes. By default, no characters are output. | j, pj, cj, cpj, htpj |
| %oa | Option to update information in the standard output file new: Outputs information to a new standard output file. add: Adds information to the existing standard output file. | j, pj |
| %ea | Option to update information in the standard error output file new: Outputs information to a new standard error output file. add: Adds information to the existing standard error output file. | j, pj |
| %Et | Time-out period 1 to 1,440 minutes | j, pj, cj, cpj, cmsj, evsj, evwj, flwj, lfwj, mlsj, mlwj, mqsj, mqwj, mssj, mswj, ntwj, plwj, pwrj, tmwj, htpj, cewj |
| %pr | Execution priority of a jobnet or job 1 to 5. The default is -. | n, rm, j, pj, qj, cj, cpj, htpj |
| %rh | Execution agent name or Execution agent group name Character string of up to 255 bytes. By default, no characters are output. For a flexible job, the name of the execution agent to be used as a relay agent or the execution agent group name is output. | n, rm, j, pj, cj, cpj, cmsj, evsj, evwj, flwj, lfwj, mlsj, mlwj, mqsj, mqwj, mssj, mswj, ntwj, plwj, pwrj, tmwj, fxj, htpj, cewj |

| Format indicator | Output information | Unit type abbreviations ^{#3} |
|------------------|---|---------------------------------------|
| %un | Target user name Character string of up to 63 bytes. By default, no characters are output. | j, pj, cj, cpj, httpj |
| %jd | End judgment normal: Always normal abnorm: Always abnormal code: Return code exist: Normal if a file is created modify: Normal if the file is updated | j, pj, qj, cj, cpj, fxj, httpj |
| %wt | Threshold for the end with warning 0 to 2,147,483,647. The default is -. | j, pj, qj, cj, cpj, fxj, httpj |
| %Th | Threshold for the abnormal end 0 to 2,147,483,647 | j, pj, qj, cj, cpj, fxj, httpj |
| %jf | End judgment file name Character string of up to 511 bytes. By default, no characters are output. | j, pj, cj, cpj, fxj, httpj |
| %Ab | Retry on abnormal end y: Automatic retry is performed for an abnormal end. n: Automatic retry is not performed for an abnormal end. | j, pj, qj, cj, cpj, fxj, httpj |
| %rs | Lower limit of the return code for automatic retry 1 to 4,294,967,295. If omitted, - is output. In this case, <i>abnormal threshold + 1</i> for end judgment is assumed at execution. Nothing is output if automatic retry is not performed on abnormal end. | j, pj, qj, cj, cpj, fxj, httpj |
| %re | Upper limit of the return code for automatic retry 1 to 4,294,967,295. If omitted, - is output. In this case, 4,294,967,295, which is the maximum value, is assumed at execution. Nothing is output if automatic retry is not performed on abnormal end. | j, pj, qj, cj, cpj, fxj, httpj |
| %rc | Maximum number of retry executions 1 to 12 (times). Nothing is output if automatic retry is not performed on abnormal end. | j, pj, qj, cj, cpj, fxj, httpj |
| %ri | Retry interval 1 to 10 (minutes). Nothing is output if automatic retry is not performed on abnormal end. | j, pj, qj, cj, cpj, fxj, httpj |
| %qu | Queue name Character string of up to 63 bytes. By default, no characters are output. | Qj |
| %qm | Queue manager host name Character string of up to 255 bytes. By default, no characters are output. | Qj |
| %rq | Job name Character string of up to 63 bytes. By default, no characters are output. | Qj |
| %s1 to %s4 | Transfer source file name Character string of up to 511 bytes. By default, no characters are output. %s1: Name of transfer source file 1 %s2: Name of transfer source file 2 %s3: Name of transfer source file 3 %s4: Name of transfer source file 4 | j, pj, qj |
| %d1 to %d4 | Transfer destination file name Character string of up to 511 bytes. By default, no characters are output. | j, pj, qj |

| Format indicator | Output information | Unit type abbreviations ^{#3} |
|------------------|--|---------------------------------------|
| %d1 to %d4 | %d1: Name of transfer destination file 1 %d2: Name of transfer destination file 2 %d3: Name of transfer destination file 3 %d4: Name of transfer destination file 4 | j, pj, qj |
| %T1 to %T4 | Option to delete the transfer destination file after the end of job execution save: Saves the file. delete: Deletes the file. | j, pj |
| %ej | Judgment method greater: Greater than the judgment value greater: equal Equal to or greater than the judgment value less: Less than the judgment value less equal: Equal to or less than the judgment value equal: Equal to the judgment value not equal: Not equal to the judgment value range in: Within the judgment value range range out: Outside the judgment value range exist: A file is created. not exist: No file is created. variable greater: The variable is greater than the judgment value. variable greater equal: The variable is equal to or greater than the judgment value. variable less: The variable is less than the judgment value. variable less equal: The variable is equal to or less than the judgment value. variable equal: The variable is equal to the judgment value. variable not equal: The variable is not equal to the judgment value. variable range in: The variable is within the judgment value range. variable range out: The variable is outside the judgment value range. string equal: The variable is equal to the judgment string. string part equal: The variable includes the judgment string. string not equal: The variable is not equal to the judgment string. string part not equal: The variable does not include a judgment string. string not null: The value of the variable exists. string null: The value of the variable does not exist. | Jdj |
| %eC | Return code for judgment 0 to 4,294,967,295 | Jdj |
| %eL | Lower limit end judgment code 0 to 4,294,967,295 This information is output when the judgment method is <i>within the judgment value range</i> or <i>outside the judgment value range</i> . | Jdj |
| %eH | Upper limit end judgment code 0 to 4,294,967,295 This information is output when the judgment method is <i>within the judgment value range</i> or <i>outside the judgment value range</i> . | Jdj |
| %eF | End judgment file name Character string of up to 260 bytes. By default, no characters are output. | Jdj |
| %jV | Variable name String of up to 64 bytes. By default, nothing is output. | Jdj |
| %jT | Judgment string for variables String of up to 511 bytes. By default, nothing is output. | Jdj |

| Format indicator | Output information | Unit type abbreviations ^{#3} |
|------------------|---|---------------------------------------|
| %jI | Judgment value for variables Value of 0 to 2,147,483,647 | Jdj |
| %jS | Lower limit variable judgment numeric value 0 to 2,147,483,647 This information is output when the judgment method indicates <i>the variable is within the judgment value range</i> or <i>the variable is outside the judgment value range</i> . | Jdj |
| %jG | Upper limit variable judgment numeric value 0 to 2,147,483,647 This information is output when the judgment method indicates <i>the variable is within the judgment value range</i> or <i>the variable is outside the judgment value range</i> . | Jdj |
| %lP | Boundary condition (lower limit) of the return code or variable judgment numeric value greater: Greater than the judgment value greater equal: Equal to or greater than the judgment value This information is output when the judgment method is <i>within the judgment value range</i> , <i>outside the judgment value range</i> , <i>the variable is within the judgment value range</i> , or <i>the variable is outside the judgment value range</i> . | Jdj |
| %uP | Boundary condition (upper limit) of the return code or variable judgment numeric value less: Smaller than the judgment value less equal: Equal to or smaller than the judgment value This information is output when the judgment method is <i>within the judgment value range</i> , <i>outside the judgment value range</i> , <i>the variable is within the judgment value range</i> , or <i>the variable is outside the judgment value range</i> . | Jdj |
| %CI | Additional status information reported to HP NNM Character string of up to 256 bytes. By default, no characters are output. | Cmsj |
| %CC | Status reported to HP NNM un: Unknown no: Normal wa: Warning mi: Minor ma: Major cr: Critical re: Restricted te: Testing di: Disabled | Cmsj |
| %ED | Detailed event information Character string of up to 1,024 bytes. By default, no characters are output. | Evwj |
| %Eg | Event issue source group ID -1 to 9,999,999,999. The default is *****. | Evwj |
| %EG | Event issue source group name Character string of up to 20 bytes. The default is *****. | Evwj |
| %EH | Event issue source host name, event destination host name Character string of up to 255 bytes. By default, no characters are output. | evsj, evwj |
| %EI | Monitor event ID Character string of up to 17 bytes. The default is *****. | Evwj |
| %eI | Send event ID | Evsj |

| Format indicator | Output information | Unit type abbreviations ^{#3} |
|------------------|--|---------------------------------------|
| %eI | Character string of up to 8 bytes. The default is *****. | Evsj |
| %Ei | Event issue source IP address Character string of up to 15 bytes. The default is *****. | Evwj |
| %eM | Event message information (Send) Character string of up to 1,023 bytes. By default, no characters are output. | Evsj |
| %EM | Event message information (Receive) Character string of up to 1,024 bytes. By default, no characters are output. | Evwj |
| %Ep | Event issue source process ID Character string of up to 10 bytes. The default is *****. | Evwj |
| %eS | Event level for the extended attribute of an event (Send) em: Sets Emergency. al: Sets Alert. cr: Sets Critical. er: Sets Error. wr: Sets Warning. no: Sets Notice. in: Sets Information. db: Sets Debug. | evsj |
| %ES | Event level for the extended attribute of an event (Receive) em: Sets Emergency as the condition to be met. al: Sets Alert as the condition to be met. cr: Sets Critical as the condition to be met. er: Sets Error as the condition to be met. wr: Sets Warning as the condition to be met. no: Sets Notice as the condition to be met. in: Sets Information as the condition to be met. db: Sets Debug as the condition to be met. | evwj |
| %Ef | Optional extended attribute of an event (Send) Character string of up to 128 bytes. By default, no characters are output. | evsj |
| %ET | Conditions of end judgment n: Always normal end a: Always abnormal end n, <i>file-name</i> : Normal end if the message matches the contents of the specified file a, <i>file-name</i> : Abnormal end if the message matches the contents of the specified file d, <i>file-name</i> : Normal end if detailed information matches the contents of the specified file b, <i>file-name</i> : Abnormal end if detailed information matches the contents of the specified file The file name consists of a character string of up to 256 bytes. | evwj |
| %Eu | Event issue source user ID -1 to 9,999,999,999. The default is *****. | evwj |
| %EU | Event issue source user name Character string of up to 20 bytes. The default is *****. | evwj |
| %EF | Optional extended attribute of an event (Receive) Character string of up to 2,048 bytes. By default, no characters are output. | evwj |
| %FC | Monitoring conditions | flwj |

| Format indicator | Output information | Unit type abbreviations ^{#3} |
|------------------|--|---------------------------------------|
| %FC | c: Monitors file creation. d: Monitors file deletion. s: Monitors file resizing. m: Monitors the changes in the updating time of the last file. | flwj |
| %FF | Name of a file to be monitored Character string of up to 255 bytes. By default, no characters are output. | flwj |
| %FI | Monitoring interval 1 to 600 seconds | flwj |
| %FO | When there is a file to be monitored y: Conditions are met (Normal termination). n: Monitoring is continued. | flwj |
| %Lw | Error option for a file not created yes: Error no: Not error | lfwj |
| %Ld | Output data format for log files s: Sequential file (Data is appended to one log file, and when the file is filled to its capacity, a new log file is created with another name, and new log data is written to the new file.) s2: Sequential file (A log file with the same name is continuously used for logging by creating a new file with the same name after backing up the current file with another name or deleting the current file.) w1: Wraparound (When log data is written to the end of the log file, the existing data is overwritten with new data, starting with the beginning of the file.) w2: Wraparound (When log data is written to the end of the log file, the existing data is deleted and then new data is written from the beginning of the file.) | lfwj |
| %LF | Log file name Character string of up to 256 bytes. By default, no characters are output. | lfwj |
| %LL | Header l: Number of rows (0 to 99,999 rows) s: Size (0 to 9,999,999 rows) -: None | lfwj |
| %LM | Data other than log information (the distinction between AND and OR is not output.) Character string of up to 1,024 bytes. By default, no characters are output. | lfwj |
| %Lm | Data other than log information Character string of up to 1,024 bytes. By default, no characters are output. A colon (:) is output for AND. A linefeed is output for OR. Output example: For "AAA" and "BBB" or "CCC" "AAA" : "BBB" "CCC" | lfwj |
| %LX | Maximum length of event data 2 to 512 (bytes) | lfwj |
| %LR | Record format of log data v: Delimits the row by a variable-length record (consisting of a character string of 3 to 4 bytes). f: Delimits the row by a fixed-length record (consisting of a character string of 1 to 9,999,999 bytes). | lfwj |
| %LI | File search interval | lfwj |

| Format indicator | Output information | Unit type abbreviations ^{#3} |
|------------------|---|---------------------------------------|
| %LI | 1 to 86,400 seconds | lfwj |
| %Ls | Search start option yes: Enters data from its top. no: Does not enter data from its top. | lfwj |
| %LD | Data to be trapped (the distinction between AND and OR is not output.) Character string of up to 2,048 bytes. By default, no characters are output. | lfwj |
| %LT | Data to be trapped Character string of up to 2,048 bytes. By default, no characters are output. A colon (:) is output for AND. A linefeed is output for OR. Output example: For "AAA" and "BBB" or "CCC" "AAA" : "BBB" "CCC" | lfwj |
| %MA | " <i>email-address</i> ", or xxx: " <i>email-address</i> " (Only for an email sending job) to: " <i>email-address</i> ": Sends email to the destination. cc: " <i>email-address</i> ": Sends an email copy to the destination. bcc: " <i>email-address</i> ": Sends an email copy to the destination; like paper BBC (blind carbon copy), this copy is hidden from other recipients. The email address consists of a character string of up to 256 bytes. | mlsj, mlwj |
| %ML | Received email list name Character string of up to 255 bytes. By default, no characters are output. | mlwj |
| %MP | Profile name Character string of up to 256 bytes. By default, no characters are output. | mlsj, mlwj |
| %Ms | Email saving yes: Saves email. no: Does not save email. | mlwj |
| %MS | Subject Character string of up to 256 bytes. By default, no characters are output. | mlsj, mlwj |
| %MF | Name of a folder to save the attached file Character string of up to 256 bytes. By default, no characters are output. | mlwj |
| %mF | Attached file name Character string of up to 256 bytes. By default, no characters are output. | mlsj |
| %mF | Name of a list file to list the attached file Character string of up to 256 bytes. By default, no characters are output. | mlsj, mlwj |
| %Mt | Name of a file to save text Character string of up to 256 bytes. By default, no characters are output. | mlwj |
| %MT | Text Character string of up to 512 bytes. By default, no characters are output. | mlsj, mlwj |
| %mt | Text file name Character string of up to 256 bytes. By default, no characters are output. | mlsj |
| %QC | Correlation ID Character string of up to 24 bytes. The default is -. | mqsj, mqwj |
| %QD | Message ID Character string of up to 24 bytes. The default is -. | mqsj, mqwj |

| Format indicator | Output information | Unit type abbreviations ^{#3} |
|------------------|---|---------------------------------------|
| %qE | Dead letter queue name Character string of up to 48 bytes. The default is -. | mqsj |
| %qH | Holding time 1 to 9,999,999 minutes. The default is -. | mqsj |
| %QM | Model queue name Character string of up to 48 bytes. The default is -. | mqsj, mqwj |
| %qd | Message data file name Character string of up to 256 bytes. By default, no characters are output. | mqsj |
| %qF | Message format name Character string of up to 8 bytes. The default is -. | mqsj |
| %qM | Queue manager name Character string of up to 48 bytes. The default is -. | mqsj |
| %qp | Program name for related queue management Character string of up to 48 bytes. The default is -. | mqsj |
| %qR | Priority 0 to 9. The default is -. | mqsj |
| %qP | Permanence yes: Permanent no: Not permanent | mqsj |
| %QQ | Queue name Character string of up to 48 bytes. The default is -. | mqsj, mqwj |
| %QS | Message storage file name Character string of up to 256 bytes. By default, no characters are output. | mqwj |
| %SA | Application information 0 to FFFFFFFF. The default is -. | mssj, mswj |
| %SH | Holding time -1 to 2,147,483,647 (seconds) | mssj |
| %sJ | Message storage to the journal queue yes: Stores the message. no: Does not store the message. | mssj |
| %SM | Message label Character string of up to 249 bytes. The default is -. | mssj, mswj |
| %sL | Delivery limit time -2 to 2,147,483,647 (seconds) | mssj |
| %sM | Delivery mode h: High-speed mode r: Recoverable mode | mssj |
| %sP | Priority 0 to 7 | mssj |
| %s1 | Queue label name Character string of up to 124 bytes. The default is -. | mssj |
| %SQ | Queue path name Character string of up to 259 bytes. By default, no characters are output. | mssj, mswj |

| Format indicator | Output information | Unit type abbreviations ^{#3} |
|------------------|---|---------------------------------------|
| %SR | Correlation ID Character string of up to 20 bytes. The default is -. | mssj, mswj |
| %SF | Message storage file name Character string of up to 256 bytes. By default, no characters are output. | mswj |
| %sF | Text file name Character string of up to 259 bytes. By default, no characters are output. | mssj |
| %sT | Text type 0 to FFFFFFFF. The default is -. | mssj |
| %sU | Message storage to the dead letter queue yes: Stores the message. no: Does not store the message. | mssj |
| %NJ | Classification judgment conditions yes: Judges the classification. no: Does not judge classification. | ntwj |
| %NC | Classification Character string of up to 255 bytes. By default, no characters are output. | ntwj |
| %ND | Explanation Character string of up to 1,024 bytes. By default, no characters are output. | ntwj |
| %Nj | Judgment conditions for an event ID yes: Judges the classification. no: Does not judge classification. | ntwj |
| %NI | Event ID Character string of up to 16 bytes. The default is -. | ntwj |
| %NE | Event type v: Monitors the verbose event. I: Monitors the information event. w: Monitors the warning event. e: Monitors the error event. c: Monitors the critical event. s: Monitors the success audit event. f: Monitors the failure audit event. | ntwj |
| %NL | Log type sys: Monitors the system log. sec: Monitors the security log. app: Monitors the application log. dns: Monitors the DNS Server log (for Windows 2000 only). dir: Monitors the Directory Service log (for Windows 2000 only). frs: Monitors the file reproduction service log (for Windows 2000 only). oth: Monitors the log type specified for %Nt (any log type). | ntwj |
| %Nt | Any log type Character string of up to 255 bytes. By default, no characters are output. | ntwj |
| %Ns | Judgment conditions for a source yes: Judges the classification. no: Does not judge classification. | ntwj |
| %NS | Source | ntwj |

| Format indicator | Output information | Unit type abbreviations ^{#3} |
|------------------|--|---|
| %NS | Character string of up to 255 bytes. The default is -. | ntwj |
| %jP | Macro variable Character string of up to 2,048 bytes. By default, no characters are output. | evwj, flwj, lfwj, mlwj, mqwj, mswj, ntwj, tmwj, cewj |
| %Mp | Platform type u: Execution in the UNIX environment p: Execution in the Windows environment and Windows-compatible environment | cmsj, evsj, mlsj, mlwj, mqsj, pwlj |
| %PT | Type of execution f: Turns off the power supply. r: Shuts down, then restarts the power supply. s: Shuts down. | pwlj |
| %Pf | Type of an end request m: Termination with monitoring r: Restrictive termination f: Kill p: Planned termination | pwlj |
| %PH | Target host name Character string of up to 255 bytes. By default, no characters are output. | pwrj |
| %PF | Request type o: Turns on the power supply. m: Termination with monitoring r: Restrictive termination f: Kill p: Forced termination s: Forced stop | pwrj |
| %PN | Time when the power supply is turned on next n: Does not set the next power-on time. a: Validates the next power-on time set for the agent. c: { [mm/dd.] hh:mm } Next power-on time mm: 1 to 12 (month) dd: 1 to 31 (day) hh: 0 to 23 (hour) mm: 0 to 59 (minute) | pwrj |
| %PR | Restart yes: Restarts the agent host. no: Does not restart the agent host. | pwrj |
| %PW | Waiting for the end of power-off yes: If you turn off the power supply for a remote power agent, the system waits for a shutdown. no: Does not wait for a shutdown. The end of power-off means that the JP1/Power Monitor on the agent host reports the start of a shutdown to the manager host of the JP1/Power Monitor. | pwrj |
| %PM | Type of platform subject to power control u: Execution in the UNIX environment p: Execution in the Windows environment and Windows-compatible environment | pwrj |
| %Tw | Waiting time 1 to 1,440 minutes. | tmwj |

| Format indicator | Output information | Unit type abbreviations ^{#3} |
|------------------|--|--|
| %Tn | Whether the unit is completed immediately after it starts y: Completed n: Not completed | tmwj |
| %gt | Job group type n: Job group p: Planning group No characters are output for a group other than a job or planning group. | g |
| %Ed | Date and time of creation | mg, g, mn, rc, n, rm, j, pj, qj, jdj, cj, cpj, orj, cmsj, evsj, evwj, flwj, lfwj, mlsj, mlwj, mqsj, mqwj, mssj, mswj, ntwj, pwlj, pwrj, tmwj, hln, nc, fxj, htpj, cewj |
| %jt | Job queuing attribute type q: Has the queuing attribute. n: Does not have the queuing attribute. | j, pj, evsj, mlsj, mqsj, mssj, cmsj, pwlj, pwrj |
| %es | Event job and custom event job time-out state k1: Killed nr: Ended normally wr: Ended with warning an: Ended abnormally | evwj, flwj, lfwj, mlwj, mqwj, mswj, ntwj, tmwj, cewj |
| %Ee | Searches for events before execution Searches for the JP1 events that occurred since the specified minutes before the JP1 event reception monitoring job was executed. 1 to 720 minutes. no: Does not search for previous JP1 events. | evwj |
| %eK | Event arrival check y: Checks the arrival of the event. n: Does not check the arrival of the event. | evsj |
| %eP | Event arrival check interval. 3 to 600 seconds. If you do not check the arrival of the event, specify -. | evsj |
| %eR | Number of times event arrival is checked 0 to 999 times. If you do not check the arrival of the event, specify -. | evsj |
| %fd | Time required for executing the jobnet or remote jobnet for which the end delay is monitored 1 to 2,879 minutes. Alternatively, the time required for executing the job. 1 to 1,440 minutes. By default, no characters are output. | n, rm, j, pj, qj, cj, cpj, cmsj, evsj, evwj, flwj, lfwj, mlsj, mlwj, mqsj, mqwj, mssj, mswj, ntwj, pwlj, pwrj, tmwj, htpj, cewj |
| %AB | Operation that occurs after a jobnet with start conditions terminates abnormally exec: Start the execution of the jobnet. hold: Hold the execution of the jobnet. stop: Stop the monitoring of start conditions. | rc |
| %mS | Startup of multiple monitoring generations multi: Another monitoring generation starts. | rc |

| Format indicator | Output information | Unit type abbreviations ^{#3} |
|------------------|--|--|
| %mS | wait: Another monitoring generation waits for the current monitoring generation to terminate. skip: Another monitoring generation does not start. | rc |
| %gs | Whether to stay an execution generation whose start conditions are satisfied yes: Execution of the jobnet is not repeated so that the generation stays. no: Execution of the jobnet is repeated so that the generation does not stay. | rc |
| %Nl | Whether to control the root jobnet execution order y: The root jobnet execution order is controlled. n: The root jobnet execution order is not controlled. | g, n |
| %Nn | Jobnet connector name Character string of no more than 930 bytes By default, no characters are output. | g, n |
| %Nm | Root jobnet execution order control method y: Root jobnets are executed synchronously with jobnet connectors. n: Root jobnets are executed asynchronously with jobnet connectors. -: The root jobnet execution order is not controlled. | g, n |
| %Nr | Name of the root jobnet to be connected Character string of no more than 930 bytes. By default, no characters are output. | nc |
| %Ud | Last update time of a unit including its subordinate units Cautionary note If the <code>ajsprint</code> command is executed with the %Ud format indicator specified, processing takes time because the command references information about all units subordinate to the target units. The processing time depends on the total number of subordinate units. | mg, g, mn, rc, n, rm, j, pj, qj, jdj, cj, cpj, orj, cmsj, evsj, evwj, flwj, lfwj, mlsj, mlwj, mqsj, mqwj, mssj, mswj, ntwj, pwlj, prwj, tmwj, hln, nc, fxj, htpj, cewj |
| %mm | Wait method and: Starts executing when all units whose ends are being waited for have finished executing. or: Starts executing when any one of the units whose ends are being waited for has finished executing. If no units whose ends are being waited for are defined for the wait condition, nothing is output. | n, j, pj, qj, cmsj, evsj, evwj, flwj, lfwj, mlsj, mlwj, mqsj, mqwj, mssj, mswj, ntwj, pwlj, prwj, tmwj, nc, cj, cpj, fxj, htpj, cewj |
| %NM | Behavior when there are no applicable generations of units whose ends are being waited for y: Start executing. n: Do not start executing. If no units whose ends are being waited for are defined for the wait condition, nothing is output. | n, j, pj, qj, cmsj, evsj, evwj, flwj, lfwj, mlsj, mlwj, mqsj, mqwj, mssj, mswj, ntwj, pwlj, prwj, tmwj, nc, cj, cpj, fxj, htpj, cewj |
| %EN | Name of unit whose end is being waited for You can specify a character string of 1 to 930 bytes. If no units whose ends are being waited for are defined for the wait condition, nothing is output. If more than one unit whose end is being waited for is defined for the wait condition, each unit appears on its own line. | n, j, pj, qj, cmsj, evsj, evwj, flwj, lfwj, mlsj, mlwj, mqsj, mqwj, mssj, mswj, ntwj, pwlj, prwj, tmwj, nc, cj, cpj, fxj, htpj, cewj |
| %an | Execution order relationship to unit whose end is being waited for The unit whose end is being waited for and the target unit are output in the following format: <i>unit-whose-end-is-being-waited-for, target-unit-name</i> | n, j, pj, qj, cmsj, evsj, evwj, flwj, lfwj, mlsj, mlwj, mqsj, mqwj, mssj, mswj, ntwj, pwlj, prwj, tmwj, nc, cj, cpj, fxj, htpj, cewj |

| Format indicator | Output information | Unit type abbreviations ^{#3} |
|------------------|---|---|
| %an | The full path name of each unit is output as a character string of no more than 930 bytes. If no units whose ends are being waited for are defined for the wait condition, nothing is output. If more than one unit whose end is being waited for is defined for the wait condition, each unit appears on its own line. | n, j, pj, qj, cmsj, evsj, evwj, flwj, lfwj, mlsj, mlwj, mqsj, mqwj, mssj, mswj, ntwj, pwlj, pwrj, tmwj, nc, cj, cpj, fxj, htj, cewj |
| %ga | Behavior when there is an abnormal end in the execution generation. No information is output if there is no unit whose end is being waited for. exec: Start executing. execdeffer: Do not start executing. Note, however, that if the execution generation is in the <i>Skipped so not exe.</i> status, execution starts. none: Do not start executing. | n, j, pj, qj, cmsj, evsj, evwj, flwj, lfwj, mlsj, mlwj, mqsj, mqwj, mssj, mswj, ntwj, pwlj, pwrj, tmwj, nc, cj, cpj, fxj, htj, cewj |
| %um | Behavior when the monitoring generation is in the <i>Unmonitored + Ended</i> status. No information is output if there is no unit whose end is being waited for. y: Start executing. n: Do not start executing. | n, j, pj, qj, cmsj, evsj, evwj, flwj, lfwj, mlsj, mlwj, mqsj, mqwj, mssj, mswj, ntwj, pwlj, pwrj, tmwj, nc, cj, cpj, fxj, htj, cewj |
| %da | Destination or broadcast agent You can specify a character string of 1 to 128 bytes. By default, no characters are output. | fxj |
| %fg | Broadcast execution method none: Do not perform broadcast execution. sync: Performs broadcast execution in synchronous mode. async: Performs broadcast execution in asynchronous mode. | fxj |
| %HC | Connection configuration file name You can specify a character string of 1 to 511 bytes. By default, no characters are output. | htj |
| %HK | Request type <ul style="list-style-type: none"> • GET • POST • PUT • DELETE | htj |
| %HS | Transmission information file name You can specify a character string of 1 to 511 bytes. By default, no characters are output. | htj |
| %HT | Statuses store file name You can specify a character string of 1 to 511 bytes. By default, no characters are output. | htj |
| %HD | How to store received data: diff: The header and body of the received data acquired from the API are output to separate files. same: The header and body of the received data acquired from the API are output to the same file. | htj |
| %HH | Received header store file name You can specify a character string of 1 to 511 bytes. By default, no characters are output. | htj |
| %HB | Received body store file name You can specify a character string of 1 to 511 bytes. By default, no characters are output. | htj |

| Format indicator | Output information | Unit type abbreviations ^{#3} |
|------------------|--|---------------------------------------|
| %HE | Extended mode y: Extended mode is used. n: Extended mode is not used. | htpj |
| %HU | Transmission information file name (URL parameter) You can specify a character string of 1 to 511 bytes. By default, no characters are output. | htpj |
| %HM | Transmission information file name (message body) You can specify a character string of 1 to 511 bytes. By default, no characters are output. | htpj |
| %HR | Return code specification You can specify a character string of 1 to 511 bytes. By default, no characters are output. | htpj |
| %CN | Custom event job name Character string of up to 16 bytes. By default, no characters are output. | cewj |
| %cp | Definition parameter Character string of up to 20,479 bytes. By default, no characters are output. | cewj |

#1

Format indicator that can be set for the `-t` option

#2

For details about the output format, see [Table 3-15](#).

#3

For details about the abbreviations of unit types, see the description of the parameter `ty=` in [5.2.1 Attribute definition](#).

Table 3–14: Other format indicators

| Format indicator | Output information |
|------------------|---------------------------|
| %% | % |
| %n | Line feed character |
| %t | Tab character |
| %x | Current date [#] |
| %X | Current time [#] |

#

Time at which you started executing the `ajspri` command. For details about the output format, see the following table:

Table 3–15: Output format of format indicators

| Format indicator | Output format |
|------------------|-----------------------------|
| %ud | <i>MMM DD YYYY hh:mm:ss</i> |
| %Ed | Example: |
| %Ud | DEC 30 2006 18:39:12 |

| Format indicator | Output format |
|-------------------------|--|
| %c1 %op %ed %x | YYYY/MM/DD Example: 2006/12/30 When not specified: ***/**/** |
| %X | hh:mm:ss Example: 12:30:30 |
| %Sd | <p>[<i>N</i>,] { [[yyyy/] <i>mm</i> /] { [+ * @] <i>dd</i> [+ * @] <i>b</i> [-<i>DD</i>] [+] { su mo tu we th fr sa } [: { <i>n</i> b }] } en ud }</p> <ul style="list-style-type: none"> • <i>N</i> indicates a rule number when multiple schedules are defined (1 to 144). • <i>yyyy</i> indicates a year of four digits. • <i>mm</i> indicates a month. • + indicates relative days. • * indicates an open day. • @ indicates a closed day. • <i>dd</i> indicates a day in a month. • <i>b</i> indicates the last day. • -<i>DD</i> indicates the number of days from the last date (1 to 35). • su, mo, tu, we, th, fr and sa indicate the days of the week beginning with Sunday (Sunday to Saturday). • <i>n</i> indicates the <i>n</i>-th week (1 to 5). <p>By default, the system assumes the start date to be the next day of the week after the date when the jobnet was registered for execution and the date when the <code>ajsschedule</code> command was executed. If you do not specify anything when either <i>year</i> or <i>month</i> is specified for the execution start date, the system assumes the first week when you register anything for execution and when you execute the <code>ajsschedule</code> command.</p> <ul style="list-style-type: none"> • en indicates the specified day to start execution. • ud indicates "undefined." |
| %St | <p>[<i>N</i>,] [+] <i>hh</i> : <i>mm</i></p> <ul style="list-style-type: none"> • <i>N</i> indicates a rule number when multiple schedules are defined (1 to 144). • + indicates relative time. • <i>hh</i> indicates hours (0 to 47). • <i>mm</i> indicates minutes (0 to 59). • When not specified: ** : ** |
| %sy %ey | <p>[<i>N</i>,] { <i>hh</i> : <i>mm</i> <i>P</i><i>mmmm</i> }</p> <ul style="list-style-type: none"> • <i>N</i> indicates a rule number when multiple schedules are defined (1 to 144). • <i>hh</i> indicates hours (0 to 47). • <i>mm</i> indicates minutes (0 to 59). • <i>P</i> indicates M (from the root jobnet), U (from the upper-level jobnet) or C (from the jobnet itself). • <i>mmmm</i> indicates minutes (0 to 2,879). • When not specified: ** : ** |

Table 3–16: Indications of the permission mode

| Digit | Meaning | value |
|-------|--|------------------------------------|
| 1 | Sets a set user ID bit and a set group ID bit for a job. | Set user ID bit provided 4 or 5 |

| Digit | Meaning | value |
|--------|--|--|
| 1 | Sets a set user ID bit and a set group ID bit for a job. | Set group ID bit provided 2 or 3 Both provided 6 or 7 Neither provided 0 or 1 |
| 2 to 4 | Octal value indicating the update, manipulation, reference, or no privilege for the owner (2nd digit), group (3rd digit), and others (4th digit) | Update: 7 Manipulation: 5 Reference: 4 or 6 No privilege: 0, 1, 2, or 3 |

Example 1

The following commands output calendar information on job group `group1` to the standard output file.

The base date is the 21st.

(1) When information on one day (October 30, 2010) is output:

```
ajsprint -c 2010/10/30 /group1
```

Output example

```
o (open day) or x (closed day)
o
```

(2) When information on one month (October 2010) is output:

```
ajsprint -c 2010/10 /group1
```

Output example

```
First Date of Output/Day of week/Standard Day/o (open day) or x (close
d day)...
Oct 2010                Wed                Oct 21 2010 o o o o x x o o o o o x x
.....
```

(3) When information on 12 months (2010) is output:

```
ajsprint -c 2010 /group1
```

Output example

```
First Date of Output/Day of week/Standard Day/o (open day) or x (close
d day)...
Jan 2010                Wed                Jan 21 2010 o o o o x x o o o o o x x .
..
Feb 2010                Sat                Feb 21 2010 o x x o o o o o x x o o o .
..
(Omitted)
Dec 2010                Mon                Dec 21 2010 x o x o o o x x x x x x x .
..
```

Example 2

Use the following commands to save and recover all the unit definition information and calendar information under the root job group "/".

Using Windows version JP1/AJS3

The procedure for saving is explained below together with how to specify commands.

1. Save the unit definition information in all the units.

```
ajsprint -a /* > c:\temp\winbackup.txt
```

2. Save the calendar information for the open and closed days in the root job group "/" (that is, the root job group AJSROOT).

```
ajsprint -d / > c:\temp\rootcal.txt
```

3. Save the base time, base day, and month term of AJSROOT.

```
ajsprint -f"-lt %st -ld %sd -md %md" / > c:\temp\calopt.txt
```

4. Save the comment, ownership, and group of AJSROOT.

```
ajsprint -f"-C %cm -o %ow -g %gr" / > c:\temp\chgopt.txt
```

For the recovery procedure, you would specify the commands as follows:

1. `ajsdefine c:\temp\winbackup.txt`
2. `ajscalendar -df c:\temp\rootcal.txt /`
3. `for /F "tokens=*" %i in (c:\temp\calopt.txt) do ajscalendar %i /`
4. `for /F "tokens=*" %i in (c:\temp\chgopt.txt) do ajschange %i /`

Using the UNIX version JP1/AJS3

The procedure for saving is explained below together with how to specify commands.

1. Save the unit definition information in all the units.

```
ajsprint -a "/*" > /tmp/unitbackup.txt
```

2. Save the calendar information for the open and closed days in the root job group "/" (that is, the root job group AJSROOT).

```
ajsprint -d / > /tmp/rootcal.txt
```

3. Save the base time, base day, and month term of AJSROOT.

```
ajsprint -f"-lt %st -ld %sd -md %md" / > /tmp/calopt.txt
```

4. Save the comment, ownership, and group of AJSROOT.

```
ajsprint -f"-C %cm -o %ow -g %gr" / > /tmp/chgopt.txt
```

For the recovery procedure, you would specify the commands as follows:

1. `ajsdefine /tmp/unitbackup.txt`
2. `ajscalendar -df /tmp/rootcal.txt /`
3. `ajscalendar 'cat /tmp/calopt.txt' /`
4. `ajschange 'cat /tmp/chgopt.txt' /`

- When you save and recover the unit definition information and calendar information according to the above procedure, make sure that none of the jobnets contained in the destination's unit are currently being executed. For this reason, we recommend that you first stop the scheduler service using the `jaajs_spmc_stop` command.
- Steps 2, 3, and 4 above are intended when all of the following options have been set: the calendar information, base time, base day, treat as, comment, ownership, and group. If any of these options is missing, using the above procedure may cause you to receive inappropriate information or encounter an error during recovery. You should confirm the contents of unit settings and select options to be specified during the recovery procedure. The following describes how to confirm the contents and how to specify options for recovery.
 - Confirm the file specified in step 2 during the saving procedure. If the file contains no output of calendar information, step 2 for recovery is unnecessary.
 - Confirm the file specified in steps 3 and 4 during the saving procedure. If the file's `ajscalendar` or `ajschange` command contains no option value setting or contains an initial value, such as a hyphen (-), you must delete the option before moving on to the recovery procedure.
- If a file created during saving is copied to another host and the copied file is recovered, you can copy all the hierarchical levels below the root job group "/".

Example 3

Search for macro variables defined in the unit placed under the jobnet (`/net1`) and output them in list form. One assumption is that there are three jobs (`job1`, `job2`, and `job3`) under this jobnet. Let us also assume that the parameter (`prm`) of `job1` has `?AJS2PARAM?` defined and that the definition of the environment variable (`env`) of `job3` has `?AJS2ENV1?` and `?AJS2ENV2?` defined.

```
ajsprint -F AJSROOT1 -v /net1
```

Output example

```
/net1/job1 prm ?AJS2PARAM?  
/net1/job3 env ?AJS2ENV1?  
/net1/job3 env ?AJS2ENV2?
```

Example 4

Collect unit definition information files for defined jobnet 1 (`/net1`), and jobnet 2 (`/net2`) created by copying jobnet 1. To ensure that no difference is generated when comparing these two files, execute the command with the `-s yes` option specified for jobnets 1 and 2.

The following shows the defined jobnet 1:

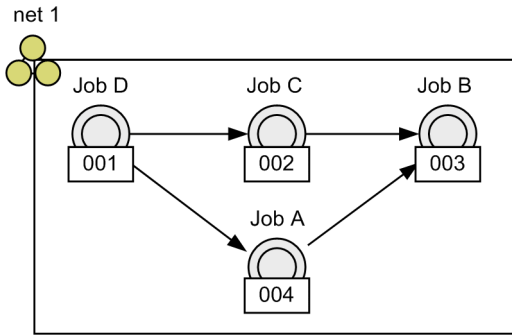

Legend:

Unit creation order

```
ajsprint -F AJSROOT1 -s yes /net1 > C:\temp\net1.txt
```

Example of output of relation line information for jobnet 1 when the `-s yes` option is specified:

```
:
ar=(f=JobA,t=JobB,seq);
ar=(f=JobC,t=JobB,seq);
ar=(f=JobD,t=JobA,seq);
ar=(f=JobD,t=JobC,seq);
:
```

The following shows jobnet 2 created by copying jobnet 1:

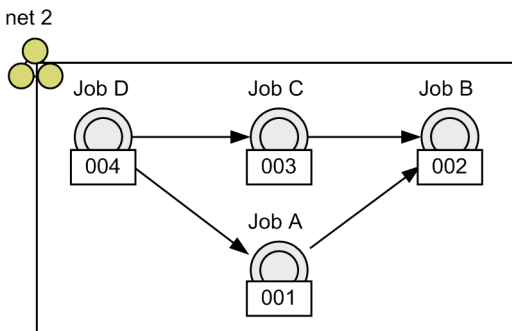

Legend:

Unit creation order

```
ajsprint -F AJSROOT1 -s yes /net2 > C:\temp\net2.txt
```

Example of output of relation line information for jobnet 2 when the `-s yes` option is specified:

```
:
ar=(f=JobA,t=JobB,seq);
ar=(f=JobC,t=JobB,seq);
ar=(f=JobD,t=JobA,seq);
ar=(f=JobD,t=JobC,seq);
:
```

Because the `-s yes` option is specified, relation line information entries are output in alphabetical order of unit names. Therefore, no difference is generated between jobnets 1 and 2.

Cautionary note

When you collect and compare unit definition information files for two units, confirm that the character set of the scheduler service (value of the `AJSCHARCODE` environment setting parameter) is the same. If the character set differs, the output order of unit definition information entries might change.

ajsprofalter

Format

```
ajsprofalter
  [-F service-name]
  -t {agent|unit}
  -m {set|unset}
```

Description

Specify this command to enable, disable, or change the settings of an operation profile.

For details, see *21.1 Setting up functions by using operation profiles* in the *JPI/Automatic Job Management System 3 Configuration Guide*.

Execution privileges

In Windows: Administrators privilege

In UNIX: Superuser privileges

Arguments

-F *service-name*

Specify the name of the scheduler service whose operation profile you want to modify. You can specify a character string of 1 to 30 bytes.

If you omit this option, the system assumes the default scheduler service name.

-t {agent|unit}

Specify the type of operation profile whose settings you want to change.

- agent
Changes the settings of an execution agent profile.
- unit
Changes the settings of a unit attribute profile.

-m {set|unset}

Enables, disables, or changes the settings of an operation profile.

- set
Applies the operation profile stored in the environment settings file storage folder[#]. Specify the operation profile type in the `-t` option, and the target scheduler service in the `-F` option.
If you apply a disabled operation profile, that operation profile becomes active. If you apply an operation profile that is already active, the operation profile settings are changed to those in effect when the command is executed.
- unset
Disables the operation profile stored in the environment settings file storage folder[#]. Specify the operation profile type in the `-t` option, and the target scheduler service in the `-F` option.

If the operation profile you specify is already disabled, the command outputs an error message and terminates abnormally.

#

The *environment settings file storage folder* refers to the following folder:

For a physical host:

Windows: *JP1/AJS3-Manager-installation-folder*\conf

UNIX: /etc/opt/jp1ajs2/conf

For a logical host:

Windows: *shared-folder*\jp1ajs2\conf

UNIX: *shared-directory*/jp1ajs2/conf

Notes

- For details on timing when changes to operation profiles take effect, see *7.10 Changing an operation profile* in the *JP1/Automatic Job Management System 3 Administration Guide*.
- If the command terminates abnormally when you use the `-m` option to enable, disable, or change the settings of an operation profile, the settings in effect before the command was executed are retained.
- When you use the `-m unset` option to disable an operation profile, the operation profile takes effect again the next time the JP1/AJS3 service starts. If you want the operation profile to stay disabled, delete the operation profile or move it to another location.
- This command can be executed regardless of whether the scheduler service is running. For this reason, it does not output log entries to the scheduler log.
- You cannot execute this command together with any of the following commands on the same logical host:

`ajsprofalter` command

`ajsembdbstart` command

`ajsembdbstop` command

`ajsstart` command

`ajsstop` command

`jajs_hstd` command

`jajs_hstd_stop` command

`jajs_spmd` command

`jajs_spmd_status` command

`jajs_spmd_stop` command

`jajs_start` command (UNIX only)

`jajs_start.cluster` command (UNIX only)

`jajs_stop` command (UNIX only)

`jajs_stop.cluster` command (UNIX only)

Return values

| | |
|--------------|--------------|
| 0 | Normal end |
| Other values | Abnormal end |

Example 1

Enables the unit attribute profile for the scheduler service *AJSROOT2*.

```
ajsprofalter -F AJSROOT2 -t unit -m set
```

Example 2

Disables the execution agent profile for the scheduler service *AJSROOT1*.

```
ajsprofalter -F AJSROOT1 -t agent -m unset
```

ajsprofstatus

Format

```
ajsprofstatus
  [-F service-name]
  -t {agent|unit}
  [-s|-p]
```

Description

Outputs the status and definition of an operation profile to the standard output file.

Execution privileges

None

Arguments

-F *service-name*

Specify the name of the scheduler service whose operation profile information you want to output. You can specify a character string of 1 to 30 bytes.

If you omit this option, the system assumes the default scheduler service name.

-t {agent|unit}

Specify the type of operation profile for which to output information.

- `agent`
Outputs information for the execution agent profile.
- `unit`
Outputs information for the unit attribute profile.

[-s|-p]

Specify the output format of the standard output file.

The operation profile to be output is stored in the environment settings file storage folder[#]. Specify the operation profile type by the `-t` option, and the target scheduler service by the `-F` option.

#

The *environment settings file storage folder* refers to the following folder:

For a physical host:

Windows: *JP1/AJS3-Manager-installation-folder*\conf

UNIX: /etc/opt/jp1ajs2/conf

For a logical host:

Windows: *shared-folder*\jp1ajs2\conf

UNIX: *shared-directory*/jp1ajs2/conf

If this option is omitted, `-s` is assumed.

- `-s`
Outputs the type, status, date and time of application, and full name of the operation profile. If the operation profile is disabled, the command does not output the date and time of application or the full profile name.
- `-p`
Outputs the definition of the active operation profile.
If the operation profile is disabled, the command outputs an error message and terminates abnormally.

Return values

| | |
|--------------|--------------|
| 0 | Normal end |
| Other values | Abnormal end |

Example 1

Outputs the status of the unit attribute profile for *AJSROOT1* to the standard output file.

```
ajsprofstatus -F AJSROOT1 -t unit
```

Example 2

Outputs the definition of the execution agent profile applied to *AJSROOT2* to the standard output file.

```
ajsprofstatus -F AJSROOT2 -t agent -p
```

Output example 1

The following shows an output example when the unit attribute profile applied to *AJSROOT1* is active and you execute the command with the `-s` option specified.

```
(1) Unit-attribute profile
(2) Status                has an effect
(3) Apply date            Jul 30 2011 20:15
(4) Operation profile name /etc/opt/jplajs2/conf/ajsprof_AJSROOT1_unit.conf
```

Explanation of the output items

(1) Unit-attribute profile

The type of operation profile to be output, as specified in the `-t` option.

(2) Status

The status of the operation profile.

(3) Apply date

If the operation profile is active, this line displays the date and time when the operation profile was applied.

This line is not output if the operation profile is disabled.

(4) Operation profile name

Outputs the full profile name if the operation profile is active.

This line is not output if the operation profile is disabled.

Output example 2

The following shows an output example when the execution agent profile applied to *AJSROOT2* is active and you execute the command with the `-p` option specified.

```
(1) @SYS_RESTRICT_START
(2) unit_path=/Group1/Work
(3) View=on
(4) ViewCheckLevel=error
(5) JobExec=on
(6) @SYS_AGENTLIST_START
(7) AGT1
(8) @SYS_AGENTLIST_END
(9) @SYS_RESTRICT_END
(10) KAVS8007-I Output of the operation profile information ended.
```

Explanation of the output items

(1) to (9) Definition of operation profile

Outputs the operation profile definition.

If the operation profile contains settings for multiple units, the command output repeats lines (1) to (9).

(10) Output completion message

A message indicating that output of the definition of the operation profile has completed.

ajsrelease

Format

```
ajsrelease
  [-F service-name]
  {-a release-target-root-jobnet-name
   -rid release-ID [-rcm release-comment]
   -rdy release-date [-rti release-time]
   -ru release-source-root-jobnet-name |
  -c release-target-root-jobnet-name |
  -i release-target-root-jobnet-name...}
```

Format1 (for making release entry)

```
ajsrelease
  [-F service-name]
  -a release-target-root-jobnet-name
  -rid release-ID
  [-rcm release-comment]
  -rdy release-date
  [-rti release-time]
  -ru release-source-root-jobnet-name
```

Format2 (for making release cancellation)

```
ajsrelease
  [-F service-name]
  -c release-target-root-jobnet-name
```

Format3 (for outputting release information)

```
ajsrelease
  [-F service-name]
  -i release-target-root-jobnet-name...
```

Description

The `ajsrelease` command can be used to perform the following operations on a root jobnet:

- Making release entry
To enter the time that the jobnet definition will be switched, and the definition to be switched
- Making release cancellation
To cancel the switching of the definition of a jobnet for which release entry has been made
- Outputting release information
To output release information

If you register a jobnet-definition release specifying a release-target jobnet for which the upper-level unit-attribute inheritance function is set, the owner and JP1 resource group of that jobnet will be set by the function. For details on this function, see *6.4.1(4)(a) Overview of the upper-level unit-attribute inheritance function* in the *JP1/Automatic Job Management System 3 System Design (Work Tasks) Guide*.

Execution privileges

You must have any of the following JP1 privileges:

For making release entry or release cancellation:

- JP1_AJS_Admin privilege
- JP1_AJS_Manager privilege
- JP1_AJS_Editor privilege and JP1_AJS_Operator privilege

For outputting release information:

- JP1_AJS_Admin privilege
- JP1_AJS_Manager privilege
- JP1_AJS_Editor privilege
- JP1_AJS_Operator privilege
- JP1_AJS_Guest privilege

Arguments

-F service-name

Specify the name of the scheduler service in which the target root jobnet (the release-target root jobnet) has been defined.

You can specify a character string of 1 to 30 bytes.

-a release-target-root-jobnet-name

Specify this option when making release entry.

Specify the full name of the release target root jobnet, which has the definitions to be switched to the new definition.

You can specify a character string of 1 to 930 bytes.

You can specify this option only if the release target root jobnet does not have jobnet definitions in *Release wait*, *Delete wait*, or *Release entry wait* status.

If the specified root jobnet does not exist, an error occurs. You cannot specify the following root jobnets:

- Root jobnet in a planning group
- Remote jobnet
- Jobnet for recovery
- Manager jobnet

-c release-target-root-jobnet-name

Specify this option when canceling the switching of the jobnet definition to a jobnet definition for which release entry is made.

Specify the full name of the root jobnet for which you want to cancel the switching of the definition.

You can specify a character string of 1 to 930 bytes.

If you specify this option, the command deletes the jobnet definitions in the *Release wait*, *Delete wait*, and *Release entry wait* statuses.

-i

Specify this option to output release information for the root jobnet.

If you specify this option, the command outputs information about the jobnet definitions in *Being applied*, *Release wait*, *Delete wait*, and *Release entry wait* statuses as release information. The command does not output release information about the jobnet definitions in other statuses.

-rid *release-ID*

Specify the release ID of the root jobnet (release-target root jobnet) definition for which the command is to be executed. You can specify a character string of 1 to 30 bytes.

You must specify this option with the **-a** option.

You must specify this option if you specify the **-a** option.

You cannot specify the following release IDs:

- A release ID associated with the release-target jobnet for which the command is to be executed.
- A release ID that begins with `AJS` (upper case)
- A release ID that includes a space, tab, linefeed, or any of the following characters:
() , / : ; = " & ' * < > ? [\] ^ ` { | } ~

You cannot specify this option with the **-c** and **-i** option.

-rcm *release-comment*

Specify a comment on the release entry you are making.

You can specify a character string of 1 to 80 bytes.

You must specify this option with the **-a** option.

You cannot specify this option with the **-C** and **-i** option.

If you omit this option, no release comment is registered.

-rdy *release-date*

Specify in the `YYYY/MM/DD` format the date on which the jobnet definition will be switched.

You can specify a value in the range from 1994/01/01 to December 31 in the year set for the `SCHEDULELIMIT` environment setting parameter. For details about the `SCHEDULELIMIT` environment setting parameter, see *20.4.2(123) SCHEDULELIMIT* in the *JP1/Automatic Job Management System 3 Configuration Guide*.

You must specify this option if you specify the **-a** option.

You cannot specify this option with the **-c** and **-i** option.

If you specify a date in the past, an error occurs. An error also occurs if you specify the same date as the release date of a jobnet definition for which release entry is already made.

-rti *release-time*

Specify in the `hh:mm` format the time at which the jobnet definition will be switched.

You can specify a value in the range from 00:00 to 23:59. If you omit this option, the system assumes 00:00.

You must specify this option with the `-a` option.

You cannot specify this option with the `-c` and `-i` option.

If you specify a time in the past, an error occurs.

`-ru release-source-root-jobnet-name`

Specify the full name of the release source root jobnet, the definition of which is to be applied to another root jobnet.

You can specify a character string of 1 to 930 bytes.

You cannot specify any of the following root jobnets:

- Root jobnet for which release entry is made
- Root jobnet in a planning group
- Remote jobnet
- Jobnet for recovery
- Manager jobnet

You must specify this option if you specify the `-a` option.

You cannot specify this option with the `-c` and `-i` option.

`release-target-root-jobnet-name . . .`

Specify the root jobnets for which you want to switch the definition.

You can specify multiple units or wildcard characters of units.

You cannot specify a character string that contains a logical host name, service name, or execution ID.

You can specify a character string of 1 to 930 bytes.

You must specify this option if you specify the `-i` option.

You cannot specify this option with the `-a` and `-c` option.

Notes

- Either of the following users can register or cancel release:
 - A user granted the operation privilege and the update privilege for the unit to be released
 - A JP1 user mapped to the OS user who has Administrators or superuser privileges
Note, however, that if `yes` is set after changing the `ADMACLIMIT` environment setting parameter from its default, even a JP1 user who was mapped to an OS user with Administrators or superuser privileges must have the operation and the update privileges.
- Either of the following users can output release information:
 - A user granted the reference privilege for the unit to be output
 - A JP1 user mapped to the OS user who has Administrators or superuser privileges

Note, however, that if `yes` is set after changing the `ADMACLIMIT` environment setting parameter from its default, even a JP1 user who was mapped to an OS user with Administrators or superuser privileges must have the reference privilege.

Notes on registering jobnets for release

- A jobnet whose schedule is later than the release time and which has been registered for fixed execution with either a period or a date specified cannot be specified as a release target. In such cases, cancel the registration or prohibit the execution of schedules after the release time, and then register the jobnet-definition release. Note, however, that if a number of future generations is also specified for the jobnet registered for fixed execution, you can register the jobnet-definition release even when the schedule of the jobnet is later than the release time.
- You cannot use the jobnet release function for jobnets of different scheduler services.
- The following jobnets cannot be specified as a release source:
 - A jobnet that has already been specified as a release target
 - A suspended jobnet
 - A jobnet being edited
 - A jobnet being used by another user
 - A jobnet for which at least two of the following are defined: a jobnet connector, a connection-destination jobnet, or a start condition (.CONDITION)
- The following jobnets cannot be specified as release targets:
 - A suspended jobnet
 - A jobnet whose status is *Shutdown*
 - A jobnet being edited
 - A jobnet being used by another user

If the other user is setting or releasing a hold attribute that applies to a unit under a jobnet whose status is *Being applied*, the jobnet can be specified as a release target.

 - A jobnet for which at least two of the following are defined: a jobnet connector, a connection-destination jobnet, or a start condition (.CONDITION)
- A jobnet whose definition is in *Release wait*, *Delete wait* or *Release entry wait* status cannot be specified as a release-target jobnet. If you want to register a jobnet definition in the *Release wait* status, wait for the jobnet status to change to *Being applied*. For a jobnet definition in *Delete wait* or *Release entry wait* status, cancel the jobnet-definition release, and then re-register it.
- The scheduler service needs to be running to register a release.
- Registering a jobnet-definition release creates a system load that is equal to or greater than the load created by the definition for the release-source jobnet. Do not register a jobnet-definition release during peak job execution times.
- If you register a jobnet-definition release specifying a release-target jobnet for which the upper-level unit-attribute inheritance function is set, the owner and JP1 resource group of that jobnet are set by the function.
- When you register a jobnet-definition release, generations after the release date are re-created based on the registered jobnet definition. Therefore, any changes made by temporarily changing the plan before the registering the jobnet-definition release are not passed to the generations after the release date (The information specified during registration for execution, such as macro variables and JP1 user, is passed). You can reinstate temporary plan changes for generations of a jobnet after its release date by using the temporary change re-execution function to re-execute of temporary changes made prior to its release. For details on this function, see *4.5.16 Displaying and re-executing temporary change operations for a job or jobnet* in the manual *JP1/Automatic Job Management System 3 Overview*.
- Even if you register, for release, a jobnet definition that (in the schedule definition) will have no next scheduled generation created, no scheduled generation will be created from that definition. Therefore, use JP1/AJS3 - View

or the `ajsshows` command to make sure that a scheduled generation has been created correctly from the jobnet definition that was released. If a scheduled generation has not been created, cancel the jobnet-definition release, review the release-source jobnet definition, and then re-register the jobnet-definition release.

- When fixed execution registration is used, the jobnet definition returns to the unregistered status if:
 - Generations exist only after the specified release date, and
 - A jobnet-definition release is registered for a jobnet definition for which (in the schedule definition) no next scheduled generation is created.

In such cases, cancel the registration of the jobnet-definition release, review the release-source jobnet definition, again register the jobnet-definition release, and then re-register the jobnet definition for execution.

- If you want to change the definition of a jobnet whose release status is *Release wait*, cancel the release, change the definition, and then perform release entry. If you do not have enough time to cancel the release or to re-do release entry, or if you want to change the definition whose status is *Being applied*, suspend the jobnet and then change the definition.
- If release entry fails, the jobnet definition remains in the *Release entry wait* status and release entry is not performed. To prevent this problem, after you perform release entry, check whether the release status of the released jobnet definition changes from *Release entry wait* to *Being applied* or *Release wait*. If release entry fails and a definition remains in the *Release entry wait* status, cancel the release to delete the definition.
- Release of the following jobnets cannot be canceled:
 - A suspended jobnet
 - A jobnet whose status is *Shutdown*
 - A jobnet being edited
 - A jobnet being used by another userIf the other user is setting or releasing a hold attribute that applies to a unit under a jobnet whose status is *Being applied*, the release of the jobnet can be canceled.
- It is not recommended that you change the JP1 resource group of the release-target unit by means of a release entry. If you use a release entry to change the JP1 resource group, a JP1 user who can access the unit that existed before the release must execute commands or use JP1/AJS3 - View even after the release.

Cautionary notes on canceling a release

- You cannot cancel release of a root jobnet that is being operated on by another user.
- You cannot cancel a release for a root jobnet that has been suspended. In such cases, release the suspension of the root jobnet and try again to cancel the release.
- You cannot cancel a release for a root jobnet in shutdown status. In such cases, cancel the execution registration of the root jobnet and try again to cancel the release.
- The scheduler service needs to be running to cancel a release.
- Canceling a release creates a system load that is equal to or greater than the load caused by deleting the jobnet definitions in the release information. Do not cancel a release during peak job execution times.
- When you cancel a release, generations are re-created based on the jobnet definition whose status becomes *Being applied* after the release is canceled. Therefore, any changes made by temporarily changing the plan before canceling the release are not passed to the jobnets after the release is canceled. Note, however, that the information specified during registration for execution, such as macro variables and JP1 users, is passed.
- If no next scheduled generation is created because of cancellation of the release of a jobnet definition whose status became *Being applied* after the cancellation, no scheduled generation will be created from that definition. Therefore, use JP1/AJS3 - View or the `ajsshows` command to make sure that the scheduled generation has been created correctly after the release is canceled. If a scheduled generation has not been created, review the jobnet definition that is in the *Being applied* status.

- When fixed execution registration is used, the jobnet definition returns to the unregistered status if:
 - Generations exist only in the jobnet definition whose release is to be canceled, and
 - No next scheduled generation is created because the release was cancelled for a jobnet definition whose status became *Being applied* after the cancellation.
 Review the jobnet definition that is in *Being applied* status after the release was canceled, and then re-register the jobnet for execution.

Cautionary notes on outputting release information

- When extracting data from the output information, extract the data based on its delimiting spaces, not by fixed byte count.

Return values

| | |
|--|--------------|
| 0 | Normal end |
| Multiple of 4 within the range from 4 to 124 | Abnormal end |

Example 1

In the following example, the command applies the definition of the *test-environment/Rel001* jobnet to the *production-environment/unit001* jobnet as release 001 at 20:00 on August 10, 2010.

```
ajsrelease -F AJSROOT1 -a / production-environment /unit001 -rid 001 -rcm 20
10/08/10 release-definition -rdy 2010/08/10 -rti 20:00 -ru / test-environmen
t /Rel001
```

Example 2

In the following example, the command removes the release entry for the *production-environment/unit001* root jobnet.

```
ajsrelease -F AJSROOT1 -c / production-environment /unit001
```

Example 3

In the following example, the command displays the release information for the *production-environment/unit001* root jobnet.

```
ajsrelease -F AJSROOT1 -i / production-environment /unit001
```

Output example

The following shows a sample execution of the command with the *-i* option specified:

```
upper job group name = /production-environment
Unit name  Release ID  Release time      Release status  Release comment  Release source jobnet
unit001    001         08 10 20XX 20:00  being applied  Aug 10-Sep 4        /test/release-model-2
unit002    002         09 05 20XX 08:30  release wait   Final release       /test/release-model-3
```

The following shows the meaning of the output.

upper job group name

The name of the upper-level job group is indicated here.

Unit name

Unit names are listed in this column.

Release ID

Release IDs are listed in this column.

Release time

Release times are listed in *MM DD YYYY HH:MM* format in this column.

Release status

Any of the following release statuses is displayed in this column.

- `release wait`:
The unit is waiting for the new definition to be applied.
- `being applied`:
The jobnet definition registered by release entry is currently applied.
- `delete wait`:
There is a definition for which release cancellation failed.
- `release entry wait`:
There is a definition for which release entry failed. Alternatively, release entry was successful but the status has not changed to *Release wait* yet.

Release comment

Comments specified when release entry was made are displayed in this column.

Release source jobnet

The name of the release source jobnet whose definition is used as the new definition is displayed in this column.

ajsrerun

Format

```
ajsrerun
  [-F service-name]
  [-B execution-registration-number]
  [{-t|-s|-n|_a|-w|-f|-p|-e}]
  [-h]
  [-c]
  [-rr [-rn number-of-retry-executions] [-ri retry-interval]]
  [-R]
  [-E]
  [-T]
  [-N|-J]
  [-X {yes|no|auto}]
  job-name-or-jobnet-name-or-job-group-name...
```

Description

Re-executes a jobnet. (Upon re-execution specification, the jobnet is executed immediately.) You can place a jobnet or job in the hold state and re-execute it later.

Execution privileges

You must have any of the following JP1 privileges:

- JP1_AJS_Admin privilege
- JP1_AJS_Manager privilege
- JP1_AJS_Operator privilege

-F *service-name*

Specify the name of the target scheduler service.

You can specify a character string of 1 to 30 bytes.

-B *execution-registration-number*

Specify the execution registration number of the jobnet you want to re-execute in the *YYYYMMDDNNN* format. The following gives the contents of *YYYYMMDDNNN*.

YYYY: Year of the date of execution

MM: Month of the date of execution

DD: Day of the date of execution

NNN: Execution registration sequence number for the date of execution

For details of the execution registration number, see *4.5.13 Methods of specifying generations when executing commands* in the manual *JP1/Automatic Job Management System 3 Overview*.

-t

Re-executes the jobnet from the top.

You can also re-execute a jobnet which has ended normally or ended with warning.

You can specify this option only in the root jobnet.

-s

Re-executes the jobnets directly under which jobs that terminated abnormally are included.

You can specify this option only in the root jobnet.

-n

Re-executes the jobs from the next job of an abnormally ended one.

However, among the units connected by a relation line, if the status of the first unit that ended abnormally is *Not executed* + *Ended* or *Skipped so not exe.*, those units will also rerun the job.

You can specify this option only in the root jobnet.

-a

Re-executes the jobs from an abnormally ended one.

You can specify this option only in the root jobnet.

-w

Re-executes a job ended with warning.

If the re-execution of a job which has ended with warning results in an abnormal end, you can further re-execute the job as a job ended with warning. (For example, job A has ended with warning and you re-execute the job (first re-execution). If job A terminates abnormally during the first re-execution, you can specify the **-w** option to further re-execute job A (second re-execution).

You can specify this option only in the root jobnet.

-f

Starts re-execution by first re-executing a specified jobnet or job.

-p

Re-executes a specified jobnet or job.

-e

Re-executes the jobnets or jobs from the next jobnet or job of a specified one.

You cannot specify this option for the root jobnet. You cannot specify this option with the **-h** option.

-h

Temporarily holds and then re-executes the target job or jobnet.

You cannot specify this option for jobnet connector. You cannot specify this option with the **-e** option.

-c

Re-executes an abnormal preceding job or jobnet after placing it in the "ended with warning" status.

-rr

Specify this option if re-execution of a target unit needs to be retried when the unit is not in the end status. When a unit ends abnormally, this option can be used to immediately run the `ajsrerun` command for the succeeding unit.

If multiple units are specified, this command retries re-execution of the units one at a time. The next retry does not start until the current retry ends.

Specifying a root jobnet causes this command to end abnormally.

Note that it is possible that this command will not retry re-execution of a target unit due to some factor other than the state of the target unit. For example, when the root jobnet of a target unit is suspended.

For details on rerunning a unit, see *4.5.11 Rerunning a job or jobnet* in the manual *JP1/Automatic Job Management System 3 Overview*. For examples of using the `-rr` option, see *2.4.6 Executing a specific process when a job ends abnormally (example of defining a jobnet that uses a recovery unit)* in the *JP1/Automatic Job Management System 3 System Design (Work Tasks) Guide*.

-rn number-of-retry-executions

Specify the number of retry executions. You can specify a value between 1 and 10.

You must specify this option with the `-rr` options. If you omit this option, the system assumes 6.

-ri retry-interval

Specify the retry interval. You can specify a value between 2 and 60 (seconds).

You must specify this option with the `-rr` options. If you omit this option, the system assumes 10.

-R

Re-executes all jobnets and jobs contained in the specified unit.

If you specify this option with the `-E` and/or `-T` options, the system re-executes jobnets and jobs according to the specification of each option.

-E

Re-executes a jobnet registered for execution.

-T

Re-executes the root jobnet.

-N

Starts re-execution by first re-executing a jobnet.

-J

Starts re-execution by first re-executing a job.

-X {yes|no|auto}

Specify whether to automatically select the current unit for operation from the units listed in a planning group. The units in the job group are not, however, automatically selected regardless of the specified value. You cannot omit a root jobnet name.

- yes

Specify this to automatically select a target unit.

When specifying a unit name in the command, omit a root jobnet name in a planning group.

- no

Specify this if you do not want to automatically select a target unit.

You must specify a unit for which the command will operate. You cannot omit a root jobnet name in a planning group.

- auto

Whether a target unit will automatically be selected depends on how the unit name is specified.

- If you want to automatically select a target unit

Specify a unit name without a root jobnet name in a planning group.

- If you do not want to automatically select a target unit

Specify a unit name with a root jobnet name in a planning group. The command will operate for the specified unit only. However, if there is a unit having the same name as the path name specified without a root jobnet name in a planning group, a root jobnet name is assumed to be omitted so that a target unit will be selected automatically.

job-name-or-jobnet-name-or-job-group-name

Specify the name of the job or jobnet you want to re-execute. You can also specify a job, jobnet, or job group name with the `-R`, `-E`, or `-T` option.

You can specify a character string of 1 to 930 bytes.

You can specify more than one job, jobnet, or job group name. You cannot specify a manager job group name or manager jobnet name.

You can specify a logical host name or execution ID as a job, jobnet, or job group name. If you specify an execution ID, however, the `-B` option is disabled. For details about how to specify the execution ID, see [1.1 Command syntax](#).

Notes

- Either of the following users can re-execute a jobnet:
 - A user granted the operation privilege when the units contained in the jobnet to be re-executed were defined or when their attributes were changed
 - A JP1 user mapped to the OS user who has Administrators or superuser privileges
Note, however, that if `yes` is set after changing the `ADMACLIMIT` environment setting parameter from its default, even a JP1 user who was mapped to an OS user who has Administrators or superuser privileges must have the operation privilege.
- This command terminates abnormally if you execute it without a scheduler service running.
- With the `-f`, `-p`, or `-e` option specified, this command terminates abnormally if:
 - The root jobnet is placed in the Being held or Waiting for the start time status.
 - The nest jobnet or job is placed in any of the following statuses: Now running, Running + Abend, Running + Warning, Being held, Waiting for the start time, Waiting for previous to end, Not sched. to exe., Now queuing, or Waiting to execute.
 - The upper-level jobnet of the nested jobnet or job does not have a schedule.
- If you re-execute a jobnet or a job during the execution of the jobnet by specifying the `-f` or `-e` option when the re-execution start point is before the job being executed, the job being executed is executed twice.
- This command terminates abnormally if the target job is a judgment job.

- If the job that is to be re-executed is a dependent job and `no` is set for the `RERUNSUBORDINATE` environment setting parameter, this command ends abnormally. For details about the `RERUNSUBORDINATE` environment setting parameter, see *20.4.2(106) RERUNSUBORDINATE* in the *JPI/Automatic Job Management System 3 Configuration Guide*.
- You cannot use this command for units subordinate to remote jobnets.
- This command terminates abnormally if the target jobnet or job is being suspended.
- When you specify that a target unit automatically be selected from the units in a planning group, an error occurs if you do not have the appropriate operation privilege for the automatically selected unit.
- When the `-X` option is omitted, a target unit in a planning group is determined according to the value specified for the `AJSAUTOJUDGE` environment variable.
- For an explanation of how to specify the name of a unit in a planning group, see *Additional information* in *ajsplan* in *3. Commands Used for Normal Operations*.
- If you specify none of the `-t`, `-s`, `-n`, `-w`, `-f`, `-p`, and `-e` options, the `-a` option is assumed.
- When you specify the `-s`, `-n`, and `-a` options, the following states are treated as abnormal end states:
 - Ended abnormally (`abnormal`)
 - Not executed + Ended (`unexec`)
 - Interrupted
 - Killed
 - Invalid exe. seq.
 - Failed to start (`fail`)
 - Unknown end status (`unknown`)
 - Skipped, so not executed (`skipped so not exe`)
- When monitoring of start conditions ends and the status changes from *Now monitoring* to any of the following, the status of the units in the root jobnet changes to *Not execute + Ended*:
 - Unmonitored + Ended
 - Monitor terminated
 - Monitor-end normal

The *Not execute + Ended* status is treated as abnormal termination. Keep this in mind when you re-execute a generation in any of the above statuses.
- Care must be taken when a root jobnet or preceding unit is re-executed as a result of a judgment job. For details, see *2.4.3 Dynamically changing a process depending on the result of a preceding job (example of defining a jobnet that uses a judgment job)* in the *JPI/Automatic Job Management System 3 System Design (Work Tasks) Guide*.

Return values

| | |
|--|--------------|
| 0 | Normal end |
| Multiple of 4 within the range from 4 to 124 | Abnormal end |

Additional information

If you attempt to re-execute a jobnet which ended on or before the previous day, schedule information for the previous execution is applied to this re-execution. The following gives an example of the re-execution.

Example:

Jobnet A that is executed every day and jobnet B that is executed only on Friday are operated as one jobnet X.

Because jobnet A ended abnormally on Thursday, however, this jobnet is re-executed on Friday.

In this example, only jobnet A is executed on Friday. As definition information for the previous execution (on Thursday) applies to the re-execution, jobnet B scheduled to be executed only on Friday is not executed.

Example

The following command re-executes the jobnet (`net1`) interrupted by the `ajsintrpt` command from the top.

```
ajsrerun -t net1
```

ajsreport

Format

```
ajsreport
  [-F scheduler-service-name] | [-d performance-log-file-storage-directory]
  [-n [-r minutes] |
      [-b year/month/day] [-s hours:minutes]
      [-e year/month/day] [-f hours:minutes]]
  [-i collection-interval]
  [-H]
```

Description

The `ajsreport` command outputs JP1/AJS3 performance reports.

Execution privileges

In Windows: Administrators privileges

In UNIX: Superuser privileges

Arguments

-F scheduler-service-name

Specify the name of the target scheduler service.

You can specify a character string of 1 to 30 bytes.

If you omit this option, the system assumes the default scheduler service name.

You cannot specify this option with the `-d` option.

-d performance-log-file-storage-directory

Specify the name of the directory in which performance log files are to be stored.

If you omit this option, the value set in the `AJSREPORTDIR` environment setting parameter is used as the storage directory.

Use the absolute path to specify the directory name. If you want to specify a directory whose name contains spaces, enclose the entire path in double quotation marks ("").

You cannot specify this option with the `-F` option.

-n

Specify this option to output the operation status that is most recent as of the date and time when the command was executed.

If you specify `-r`, the command outputs the operation status for the number of minutes (specified for `-r`) immediately before the zero seconds (.000) of the command execution time. The value specified for `-r` is based on the zero seconds on the date and time that the command was executed.

If you specify `-i`, you can specify the interval at which the operation status is to be collected within the time range specified for `-r`.

You cannot specify this option with the `-b`, `-s`, `-e`, and `-f` options.

`-r` *minutes*

Specify the number of minutes before the time at which the command was executed.

The default is 1 (minute).

You cannot specify this option with the `-b`, `-s`, `-e`, and `-f` options.

- *minutes*
You can specify a value between 1 and 1,440 for the minute.

`-b` *year/month/day*

Specify the start date of the period for which the operating status is to be output.

If you omit this option, the start date is assumed to be the date on which the command was executed.

You cannot specify this option with the `-n` and `-r` options.

- *year*
You can specify a value between 1994 and 2099 for the year.
- *month*
You can specify a value between 1 (or 01) and 12.
- *day*
You can specify a value between 1 (or 01) and 31.

`-s` *hours:minutes*

Specify the start time of the period for which the operating status is to be output.

If you omit this option, the start time is assumed to be 00:00.

You cannot specify this option with the `-n` and `-r` options.

- *hours*
You can specify a value between 0 (or 00) and 23.
- *minutes*
You can specify a value between 0 (or 00) and 59.

`-e` *year/month/day*

Specify the end date of the period for which the operating status is to be output.

If you omit this option, the end date is assumed to be the same as the start date specified for `-b`.

You cannot specify this option with the `-n` and `-r` options.

You cannot specify a date earlier than the start date that is specified for the `-b` option or that is set by default.

- *year*

You can specify a value between 1994 and 2099 for the year.

- *month*

You can specify a value between 1 (or 01) and 12.

- *day*

You can specify a value between 1 (or 01) and 31.

-f hours:minutes

Specify the end time of the period for which the operating status is to be output.

If you omit this option, the end time is assumed to be 24 hours after the start time.

If you omit both the -e option and -f option, the end date and time are calculated by adding 24 hours to the start date and time.

You cannot specify this option with the -n and -r options.

The date and time you specify for the -e and -f options cannot be same or earlier than the date and time you specify for the -b and -s options.

- *hours*

You can specify a value between 0 (or 00) and 23.

- *minutes*

You can specify a value between 0 (or 00) and 59.

The following table shows examples of performance report collection periods specified by using combinations of the -b, -s, -e, and -f options.

Table 3–17: Examples of performance report collection periods based on specified by using combinations of the -b, -s, -e, and -f options (when the command is executed on 2018-04-08)

| N o. | -b option | -s option | -e option | -f option | Start date and time | End date and time | Collection period |
|------|------------|-----------|-----------|-----------|---------------------|-------------------|---|
| 1 | Omitted | Omitted | Omitted | Omitted | 2018/04/08 00:00 | 2018/04/09 00:00 | 1 day from 2018-04-08 00:00:00.000 to 2018-04-08 23:59:59.999 |
| 2 | 2018/04/01 | Omitted | Omitted | Omitted | 2018/04/01 00:00 | 2018/04/02 00:00 | 1 day from 2018-04-01 00:00:00.000 to 2018-04-01 23:59:59.999 |
| 3 | Omitted | 09:00 | Omitted | Omitted | 2018/04/08 09:00 | 2018/04/09 09:00 | Approximately 1 day from 2018-04-08 09:00:00.000 to 2018-04-09 08:59:59.999 |
| 4 | 2018/04/01 | 11:00 | Omitted | Omitted | 2018/04/01 11:00 | 2018/04/02 11:00 | Approximately 1 day from 2018-04-01 11:00:00.000 to 2018-04-02 10:59:59.999 |

| N o. | -b option | -s option | -e option | -f option | Start date and time | End date and time | Collection period |
|------|------------|-----------|------------|-----------|---------------------|-------------------|--|
| 5 | Omitted | Omitted | 2018/04/08 | Omitted | 2018/04/08 00:00 | 2018/04/09 00:00 | 1 day from 2018-04-08 00:00:00.000 to 2018-04-08 23:59:59.999 |
| 6 | Omitted | Omitted | Omitted | 20:00 | 2018/04/08 00:00 | 2018/04/08 20:00 | Approximately 1 day from 2018-04-08 00:00:00.000 to 2018-04-08 19:59:59.999 |
| 7 | Omitted | Omitted | 2018/04/08 | 22:30 | 2018/04/08 00:00 | 2018/04/08 22:30 | Approximately 1 day from 2018-04-08 00:00:00.000 to 2018-04-08 22:29:59.999 |
| 8 | 2018/04/01 | Omitted | 2018/04/07 | Omitted | 2018/04/01 00:00 | 2018/04/08 00:00 | 7 days from 2018-04-01 00:00:00.000 to 2018-04-07 23:59:59.999 |
| 9 | Omitted | 11:00 | Omitted | 22:30 | 2018/04/08 11:00 | 2018/04/08 22:30 | Approximately 0.5 days from 2018-04-08 11:00:00.000 to 2018-04-08 22:29:59.999 |
| 10 | 2018/04/01 | 08:00 | 2018/04/07 | 21:30 | 2018/04/01 08:00 | 2018/04/07 21:30 | Approximately 7 days from 2018-04-01 08:00:00.000 to 2018-04-07 21:29:59.999 |

-i *collection-interval*

Specify the interval at which to collect the operating status.

The default is 1 (minute).

If you specify this option at the same time as the `-r` option, the value you specify for this option must not be greater than the value you specify for the `-r` option.

- *collection-interval*
You can specify a value between 1 and 1,440 for the minute.

-H

Specify this option if you do not want to output header information (including the date and time when the command was executed, the command specification details, and item names) for the operating status.

Notes

- This command cannot be executed remotely.
- Always separate the option and its value by at least one space character.
- You cannot use regular expressions when you specify scheduler service names.

- This command outputs the results collected at the system time. The local date and time setting of a scheduler service is not applied.
- If you execute this command while a jobnet or job is running, information about the jobnet or job whose status changed during execution is not included in the collection results. This information is assumed as the information after the start of the collection.
- You cannot execute this command by specifying a directory path on another host for the `-d` option, or by specifying a performance log file that was recorded in a different OS environment.
- If the message "KAVS1112-E" is output when the `ajsreport` command is executed, make sure that the performance log file storage directory exists.
- This command increases the execution time and memory usage of the command as the report period increases. If you want to shorten the execution time of the `ajsreport` command, or reduce the impact of increased memory usage, specify a shorter report output period and execute the `ajsreport` command separately.
- When the `ajsreport` command is executed, the CPU load is temporarily increased by the process of the `ajsreport` command. We recommend to execute the `ajsreport` command when the CPU load is low.

Return values

| | |
|-----|---|
| 0 | Normal end |
| 4 | An environment variable used for command execution is incorrect. |
| 8 | An argument specified in the command is incorrect. |
| 12 | Memory became insufficient during command processing. |
| 24 | Permission to execute the command is not granted. |
| 32 | The performance log file contains an invalid record. |
| 40 | A system limit was exceeded during allocation of shared memory, file descriptors, or resources for exclusive use. |
| 120 | An unexpected error was detected for an OS system call. |
| 124 | An unexpected error was detected in JP1/AJS internal processing. |

Items output to a performance report

The following describes the items that are output to a performance report.

Table 3–18: List of items output to a performance report

| No. | Item | Description | Collection type ^{#1} |
|-----|--------------------------|--|-------------------------------|
| 1 | RJ_EXEC_START_NUM | Number of root jobnets or root remote jobnets whose execution has started. This value is incremented according to the number of jobnets that are placed in the <i>Now running</i> status. | Number/time |
| 2 | CONDRJ_MONITOR_START_NUM | Number of monitoring generations of jobnets with start conditions for which monitoring has started. This value is incremented according to the number of monitoring generations that are placed in the <i>Now monitoring</i> status. | Number/time |
| 3 | CONDRJ_EV_DETECTED_NUM | Number of satisfied start conditions for a jobnet with start conditions. This value is incremented according to the number of jobnets whose start conditions are satisfied. | Number/time |
| 4 | CONDRJ_EXEC_START_NUM | Number of execution generations (of jobnets with start conditions) whose execution has started. This value is incremented according | Number/time |

| No. | Item | Description | Collection type ^{#1} |
|-----|-----------------------------|--|-------------------------------|
| 4 | CONDRJ_EXEC_START_NUM | to the number of execution generations that are placed in the <i>Now running</i> status. | Number/time |
| 5 | NEST_EXEC_START_NUM | Number of nested jobnets or nested remote jobnets whose execution has started. This value is incremented according to the number of jobnets that are placed in the <i>Now running</i> status. | Number/time |
| 6 | JOB_EXECWAIT_NUM | Number of jobs ^{#2} that changed to the <i>Waiting to execute</i> status. This value is incremented according to the number of jobs that are placed in the <i>Waiting to execute</i> status. | Number/time |
| 7 | JOB_TRANSITTED_QUEUEING_NUM | Number of jobs ^{#2} that changed to the <i>Now queuing</i> status. This value is incremented according to the number of jobs that are placed in the <i>Now queuing</i> status. | Number/time |
| 8 | JOB_EXEC_START_NUM | Number of jobs ^{#2} whose execution has started. This value is incremented according to the number of jobs that are placed in the <i>Now running</i> status. | Number/time |
| 9 | EVJOB_EXEC_START_NUM | Number of event jobs and custom event jobs whose execution has started. This value is incremented according to the number of jobs that are placed in the <i>Now running</i> status. | Number/time |
| 10 | QLJOB_EXEC_START_NUM | Number of queueless jobs whose execution has started. This value is incremented according to the number of jobs that are placed in the <i>Now running</i> status. | Number/time |
| 11 | OTHERJOB_EXEC_START_NUM | Number of OR jobs and judgment jobs whose execution has started. This value is incremented each time execution of an OR job or a judgment job begins. | Number/time |
| 12 | JOBCON_EXEC_START_NUM | Number of jobnet connectors whose execution has started. This value is incremented according to the number of jobnet connectors that are placed in the <i>Now running</i> status. | Number/time |
| 13 | RJ_EXEC_END_N_NUM | Number of root jobnets or root remote jobnets that terminated normally. This value is incremented according to the number of jobnets that are placed in the <i>Ended normally</i> status. This item is also applicable to cases where rerunning of monitoring generations of jobnets with start conditions terminated normally. | Number/time |
| 14 | RJ_EXEC_END_W_NUM | Number of root jobnets or root remote jobnets that ended with warning detected. This value is incremented according to the number of jobnets that are placed in the <i>Ended with warning</i> status. This item is also applicable to cases where rerunning of monitoring generations of jobnets with start conditions terminated with a warning detected. | Number/time |
| 15 | RJ_EXEC_END_E_NUM | Number of root jobnets or root remote jobnets that ended abnormally. This value is incremented according to the number of jobnets that are placed in any of the following statuses: <ul style="list-style-type: none"> • Ended abnormally • abnormal-WR • Invalid exe. seq. • Interrupted • Killed • kill-WR | Number/time |
| 16 | CONDRJ_MONITOR_END_N_NUM | Number of monitoring generations of jobnets with start conditions that changed to the <i>Monitor-end normal</i> status. This value is incremented according to the number of jobnets that are placed in the <i>Monitor-end normal</i> status. | Number/time |

| No. | Item | Description | Collection type ^{#1} |
|-----|-----------------------------------|--|-------------------------------|
| 17 | CONDRJ_NOMONITOR_END_NUM | Number of monitoring generations of jobnets with start conditions that changed to the <i>Unmonitored + Ended</i> status. This value is incremented according to the number of jobnets that are placed in the <i>Unmonitored + Ended</i> status. | Number/time |
| 18 | CONDRJ_MONITOR_END_ENUM | Number of monitoring generations of jobnets with start conditions that changed to the <i>Monitor terminated</i> status. This value is incremented according to the number of jobnets that are placed in the <i>Monitor terminated</i> status. | Number/time |
| 19 | CONDRJ_MONITOR_STOPPED_END_NUM | Number of monitoring generations of jobnets with start conditions that changed to the <i>Interrupted monitoring</i> status. This value is incremented according to the number of jobnets that are placed in the <i>Interrupted monitoring</i> status. | Number/time |
| 20 | CONDRJ_EXEC_END_N_NUM | Number of execution generations of jobnets with start conditions that changed to the <i>Ended normally</i> status. This value is incremented according to the number of jobnets that are placed in the <i>Ended normally</i> status. | Number/time |
| 21 | CONDRJ_EXEC_END_W_NUM | Number of execution generations of jobnets with start conditions that changed to the <i>Ended with warning</i> status. This value is incremented according to the number of jobnets that are placed in the <i>Ended with warning</i> status. | Number/time |
| 22 | CONDRJ_EXEC_END_E_NUM | Number of execution generations of jobnets with start conditions that ended abnormally. This value is incremented according to the number of jobnets that are placed in any of the following statuses: <ul style="list-style-type: none"> • Ended abnormally • abnormal-WR • Invalid exe. seq. • Interrupted • Killed • kill-WR | Number/time |
| 23 | NEST_EXEC_END_N_NUM | Number of nested jobnets or nested remote jobnets that terminated normally. This value is incremented according to the number of jobnets that are placed in the <i>Ended normally</i> status. | Number/time |
| 24 | NEST_EXEC_END_W_NUM | Number of nested jobnets or nested remote jobnets that ended with warning detected. This value is incremented according to the number of jobnets that are placed in the <i>Ended with warning</i> status. | Number/time |
| 25 | NEST_EXEC_END_E_NUM | Number of nested jobnets or nested remote jobnets that ended abnormally. This value is incremented according to the number of jobnets that are placed in any of the following statuses: <ul style="list-style-type: none"> • Ended abnormally • abnormal-WR • Invalid exe. seq. • Interrupted • Killed • kill-WR | Number/time |
| 26 | JOB_END_NOTIFICATION_DETECTED_NUM | Number of jobs ^{#2} whose end was detected. This value is incremented when a job end notification is received from an agent. Note that this value is also incremented when a job is terminated either forcibly or due to an error. However, as in the following cases, if an error occurs before the reception of a job finishes, the job is not counted. <ul style="list-style-type: none"> • A job, for which a non-existing execution agent group or execution agent is specified, is registered for execution. | Number/time |

| No. | Item | Description | Collection type ^{#1} |
|-----|-----------------------------------|---|-------------------------------|
| 26 | JOB_END_NOTIFICATION_DETECTED_NUM | <ul style="list-style-type: none"> A QUEUE job, for which a non-existing queue or agent is specified, is registered for execution. | Number/time |
| 27 | JOB_EXEC_END_N_NUM | Number of jobs ^{#2} that terminated normally. This value is incremented according to the number of jobs that are placed in the <i>Ended normally</i> status. | Number/time |
| 28 | JOB_EXEC_END_W_NUM | Number of jobs ^{#2} that ended with a warning detected. This value is incremented according to the number of jobs that are placed in the <i>Ended with warning</i> status. | Number/time |
| 29 | JOB_EXEC_END_E_NUM | Number of jobs ^{#2} that terminated abnormally. This value is incremented according to the number of jobs that are placed in any of the following statuses: <ul style="list-style-type: none"> Ended abnormally abnormal-WR Killed kill-WR Failed to start fail-WR Unknown end status unknown-WR | Number/time |
| 30 | EVJOB_DETECTED_EV_NUM | Number of event job and custom event job notifications received from an agent. This value does not match the number of detected events because the number of satisfied start conditions for a jobnet with start conditions depends on the valid range setting. To confirm the number of satisfied start conditions, see CONDRJ_EV_DETECTED_NUM. | Number/time |
| 31 | EVJOB_EXEC_END_N_NUM | Number of event jobs and custom event jobs that terminated normally. This value is incremented according to the number of jobs that are placed in the <i>Ended normally</i> status. | Number/time |
| 32 | EVJOB_EXEC_END_W_NUM | Number of event jobs and custom event jobs that ended with a warning detected. This value is incremented according to the number of jobs that are placed in the <i>Ended with warning</i> status. | Number/time |
| 33 | EVJOB_EXEC_END_E_NUM | Number of event jobs and custom event jobs that terminated abnormally. This value is incremented according to the number of jobs that are placed in any of the following statuses: <ul style="list-style-type: none"> Ended abnormally abnormal-WR Killed kill-WR Failed to start fail-WR Unknown end status unknown-WR | Number/time |
| 34 | QLJOB_EXEC_END_N_NUM | Number of queueless jobs that terminated normally. This value is incremented according to the number of jobs that are placed in the <i>Ended normally</i> status. | Number/time |
| 35 | QLJOB_EXEC_END_W_NUM | Number of queueless jobs that ended with a warning detected. This value is incremented according to the number of jobs that are placed in the <i>Ended with warning</i> status. | Number/time |

| No. | Item | Description | Collection type ^{#1} |
|-----|-------------------------------|--|-------------------------------|
| 36 | QLJOB_EXEC_END_E_NUM | Number of queueless jobs that terminated abnormally. This value is incremented according to the number of jobs that are placed in any of the following statuses: <ul style="list-style-type: none"> • Ended abnormally • abnormal-WR • Killed • kill-WR • Failed to start • fail-WR • Unknown end status • unknown-WR | Number/time |
| 37 | OTHERJOB_EXEC_END_N_NUM | Number of OR jobs and judgment jobs that changed to the <i>Ended normally</i> or <i>Normal end + False</i> status. This value is incremented according to the number of jobs that are placed in the <i>Ended normally</i> or <i>Normal end + False</i> status. | Number/time |
| 38 | OTHERJOB_EXEC_END_E_NUM | Number of judgment jobs that terminated with an error detected. This value is incremented according to the number of jobs that are placed in the <i>Ended abnormally</i> status. | Number/time |
| 39 | JOBCON_EXEC_END_N_NUM | Number of jobnet connectors that terminated normally. This value is incremented according to the number of jobnet connectors that are placed in the <i>Ended normally</i> status. | Number/time |
| 40 | JOBCON_EXEC_END_W_NUM | Number of jobnet connectors that ended with a warning detected. This value is incremented according to the number of jobnet connectors that are placed in the <i>Ended with warning</i> status. | Number/time |
| 41 | JOBCON_EXEC_END_E_NUM | Number of jobnet connectors that terminated abnormally. This value is incremented according to the number of jobnet connectors that are placed in any of the following statuses: <ul style="list-style-type: none"> • Ended abnormally • Killed • Unknown end status | Number/time |
| 42 | CONDRJ_EXEC_START_BACKLOG_NUM | Total number of execution generations among the jobnets that have start conditions whose conditions were satisfied but that did not start, and whose statuses are waiting for start condition or being held. For potential reasons behind the failure of a jobnet to start even though the jobnet's start condition was satisfied, see 3.4.6 <i>Retention of execution generations with satisfied start conditions</i> in the manual <i>JP1/Automatic Job Management System 3 Overview</i> or 3.4.7 <i>Suppressing further executions of a jobnet with start conditions after it abnormally terminates</i> in the manual <i>JP1/Automatic Job Management System 3 Overview</i> . | Total |
| 43 | JOB_SUBMIT_RETRY_BACKLOG_NUM | Total number of submission-enabled jobs ^{#2} that failed to be submitted due to overflow of the job-execution information communication buffer. The communications buffer for job execution information overflows if many jobs are submitted at the same time. | Total |
| 44 | JOB_QUEUING_BACKLOG_NUM | Total number of jobs ^{#2} in the following statuses: <ul style="list-style-type: none"> • Waiting to execute • Now queuing | Total |
| 45 | EVJOB_QUEUING_BACKLOG_NUM | Total number of event jobs and custom event jobs in the <i>Now queuing</i> status. | Total |

| No. | Item | Description | Collection type ^{#1} |
|-----|--|---|-------------------------------|
| 46 | EVJOB_START_BACKLOG_NUM | Number of unprocessed event jobs and custom event jobs for which the scheduler service has not received a start notification, among the jobs that started event monitoring on an agent. | Total |
| 47 | CONDRJ_EXEC_END_BACKLOG_NUM | Total number of unprocessed jobnets for which the scheduler service has not received a notification of satisfied conditions, among the jobnets for which start conditions are satisfied. | Total |
| 48 | JOB_EXEC_END_BACKLOG_NUM | Total number of jobs that have not changed to an end status after the end of job ^{#2} was detected. This value is incremented when the end of a job is detected, and is decremented when a job changes to an end status. | Total |
| 49 | EVJOB_DETECTED_NOTIFICATION_WITHOUT_EV_END_BACKLOG_NUM | Total number of unprocessed notifications that failed to be sent to the scheduler service, except for the notifications of satisfied events of event jobs and custom event jobs received from the agent. | Total |
| 50 | EVJOB_DETECTED_EV_END_BACKLOG_NUM | Total number of unprocessed notifications that failed to be sent to the scheduler service, among the notifications of satisfied events of event jobs and custom event jobs received from the agent. | Total |
| 51 | JOB_EXCEEDED_MAX_CONEXE | Indicates whether the maximum number of concurrently executable jobs ^{#2} (except for QUEUE jobs) is reached. 0: The maximum number of concurrently executable jobs is not reached. 1: The maximum number of concurrently executable jobs is reached. If one of the following conditions is met, the system assumes that the maximum number of concurrently executable jobs is not reached: <ul style="list-style-type: none"> • A job is executed on an execution agent for which the maximum number of concurrently executable jobs is set to 0. • Even if the maximum number of concurrently executable jobs is reached on an execution agent linked to the execution agent group, jobs can be transferred to another execution agent. | Presence/time |
| 52 | JOB_MAXIMUM_TRANSFER_FILE_SIZE | The size (in bytes) of the transfer file for the largest job ^{#2} in the collection interval (excluding QUEUE jobs) is displayed. If multiple transfer files are specified for one job, the total size of those files is indicated. Note that the indicated value is larger than the actual file size by hundreds of bytes. If the value of the <code>ReceiveFileSizeStatus</code> environment setting parameter is set to 1, 2, or 3, the system does not receive a transfer file when the maximum reception size is reached. At this time, the maximum size of the transfer file is set to 0. | Max./time |
| 53 | JOB_ERROR_AGENT_DETECTED | Indicates whether an error agent exists when jobs ^{#2} (except for QUEUE jobs) are executed. 0: No error agent exists. 1: An error agent exists. The system indicates 1 if job transfer to an execution agent failed. Note that, if the job is sent directly to an execution agent that is working normally (without first being sent to an agent that has failed), 0 is displayed. Example: When execution agents AGT1 and AGT2 are linked to execution agent group AGTGR The system assumes that an error agent exists if: When an attempt to send a job to AGT1 fails, and then an attempt to send the job to AGT2 succeeds. | Presence/time |

| No. | Item | Description | Collection type ^{#1} |
|-----|--|---|-------------------------------|
| 53 | JOB_ERROR_AGENT_DETECTED | The system assumes that no error agent exists if: Job transfer to AGT1 is not performed and job transfer to AGT2 is successful. | Presence/time |
| 54 | EVJOB_ERROR_AGENT_DETECTED | Indicates whether an error agent exists when event jobs and custom event jobs are executed. 0: No error agent exists. 1: An error agent exists. | Presence/time |
| 55 | JOB_MAXIMUM_RESULT_FILE_SIZE | The size (in bytes) of the result files for the largest job ^{#2} in the collection interval (excluding QUEUE jobs) is displayed. When 1, 2, or 3 is specified for the environment setting parameter ReceiveFileSizeStatus, data in excess of the upper limit on the size of received files is discarded. However, the data size displayed for this item includes the size of the discarded data. Note that the indicated value is larger than the actual file size by hundreds of bytes. | Max./time |
| 56 | RUNNING_AND_SCHEDULED_NEXT_GENERATIONS_NUM | Total number of generations that are being executed, or that are scheduled to be executed next. Result generations for which execution is complete and generations that are scheduled for execution after the generations to be executed next are not included. Generations that are being executed, or that are scheduled to be executed next applies to the generations that have the following statuses. <ul style="list-style-type: none"> • running • WA-cont • AB-cont • monitoring • holding • condition-wait • time-wait | Total |
| 57 | ALL_NOEXEC_END_UNITS_NUM | The number of units that ended without being executed. This number increases when a unit transitions to one of the following statuses. The calculation of this number does not include status transitions that occur when the scheduler service is started. <ul style="list-style-type: none"> • Unmonitored + Ended^{#3} • Skipped so not exe. • Bypassed • Not executed + Ended • Not executed + Ended-W | Number/time |
| 58 | DELAY_NET_START_NUM | Number of jobnet-start delays. This value is incremented when the jobnet delay monitor function detects a start delay. | Number/time |
| 59 | DELAY_NET_END_NUM | Number of jobnet-end delays. This value is incremented when the jobnet delay monitor function detects an end delay. | Number/time |
| 60 | DELAY_ALLJOB_END_NUM | Number of end delays of jobs ^{#2} , event jobs and custom event jobs. This value is incremented when the end delay monitor function based on the time required for executing jobs ^{#2} , event jobs and custom event jobs detects an end delay. | Number/time |
| 61 | CONTENTJOB_NUM | Number of concurrently executed jobs ^{#2} (sum total of the number of jobs ^{#2} in the <i>Now queuing</i> status and <i>Now running</i> status). The largest value in the collection intervals is displayed. | Max./time |

| No. | Item | Description | Collection type ^{#1} |
|-----|----------------------------|--|-------------------------------|
| 62 | EVJOB_UNREPORTED_EVENT_NUM | Total number of the following reports that were not sent to the scheduler service. The largest value in the collection intervals is displayed. <ul style="list-style-type: none"> • Event job start report • Custom event job start report • Start condition match report • Event establishment report • Report of other than event establishment (for example, forced termination) | Max./time |

#1

The following shows the collection type of performance reports.

| Collection type | Description |
|-----------------|---|
| Number/time | Indicates the number as a result of increment starting from 0 in the collection period. |
| Max./time | Indicates the maximum value recorded for the target item in the collection period. |
| Presence/time | Indicates whether an event of the target item occurred in the collection period. |
| Total | Indicates the sum total for the target item when the collection period has elapsed. |

#2

Jobs indicate PC jobs, Unix jobs (excluding queueless jobs), QUEUE jobs, flexible jobs, HTTP connection jobs, custom jobs, action jobs (excluding queueless jobs), and passing information setting jobs.

#3

The calculation of this number does not include units that transition to the *Unmonitored + Ended* status after monitoring of their corresponding monitoring generation starts. However, the calculation of this number does include units that transition to the *Unmonitored + Ended* status without their corresponding execution generation starting.

Example 1

The following command outputs the operating status on the current date (2018-01-01).

```
ajsreport
```

Output example

```
#exectime: 2018/01/01 19:00:13
#command: ajsreport
#DATE,RJ_EXEC_START_NUM,CONDRJ_MONITOR_START_NUM,CONDRJ_EV_DETECTED_NUM, .
..
2018/01/01 00:00,0,0,0,...
2018/01/01 00:01,0,0,0,...
      :      ,:,:,.,...
2018/01/01 23:59,0,0,0,...
```

Example 2

The following command outputs the operating status, without header information, on the current date (2018-01-01).

```
ajsreport -H
```

Output example

```
2018/01/01 00:00,0,0,0,...
2018/01/01 00:00,0,0,0,...
      :      ,:,:,:,...
2018/01/01 23:59,0,0,0,...
```

Example 3

The following command outputs the operating status for the command execution time (15:10) on the current date (2018-01-01).

```
ajsreport -n
```

Output example

```
#exectime: 2018/01/01 15:10:34
#command: ajsreport -n
#DATE,RJ_EXEC_START_NUM,CONDRJ_MONITOR_START_NUM,CONDRJ_EV_DETECTED_NUM, .
..
2018/01/01 15:09,0,0,0,...
```

Example 4

The following command outputs the operating status for 10 minutes before the command execution time (15:10) on the current date (2018-01-01).

```
ajsreport -n -r 10
```

Output example

```
#exectime: 2018/01/01 15:10:34
#command: ajsreport -n -r 10
#DATE,RJ_EXEC_START_NUM,CONDRJ_MONITOR_START_NUM,CONDRJ_EV_DETECTED_NUM, .
..
2018/01/01 15:00,0,0,0,...
2018/01/01 15:01,0,0,0,...
      :      ,:,:,:,...
2018/01/01 15:09,0,0,0...
```

Example 5

The following command outputs the operating status for the period from 9:00 to 21:30 on the current date (2018-01-01).

```
ajsreport -s 9:00 -f 21:30
```

Output example

```
#exectime: 2018/01/01 22:02:51
#command: ajsreport -s 9:00 -f 21:30
#DATE,RJ_EXEC_START_NUM,CONDRJ_MONITOR_START_NUM,CONDRJ_EV_DETECTED_NUM, .
..
2018/01/01 09:00,0,0,0,...
2018/01/01 09:01,0,0,0,...
```

```
2018/01/01 21:29,0,0,0,0,...
```

Example 6

The following command outputs the operating status of the scheduler service AJSROOT2 for the period from 9:00 on 2018-01-02 to 09:00 on 2018-01-03 at intervals of 7 minutes.

The last row is less than the collection interval of 7 minutes. Therefore, the command outputs the operating status for the period up to the end time of the collection range (in this case, 5 minutes from 08:55 on 2018-01-03).

```
ajsreport -F AJSROOT2 -b 2018/01/02 -s 9:00 -i 7
```

Output example

```
#exectime: 2018/01/03 12:17:26
#command: ajsreport -F AJSROOT2 -b 2018/01/02 -s 9:00 -i 7
#DATE,RJ_EXEC_START_NUM,CONDRJ_MONITOR_START_NUM,CONDRJ_EV_DETECTED_NUM,.
..
2018/01/02 09:00,0,0,0,0,...
2018/01/02 09:07,0,0,0,0,...
      :      ,:,:,:,...
2018/01/03 08:55,0,0,0,0,...
```

Example 7

The following command outputs the operating status for the period of seven days from 2018-07-01 to 2018-07-07 at intervals of five hours (300 minutes).

The last row is less than the collection interval of 5 hours (300 minutes). Therefore, the command outputs the operating status for the period up to the end time of the collection range (in this case, 180 minutes from 21:00 on 2018-07-07).

```
ajsreport -b 2018/07/01 -e 2018/07/07 -i 300
```

Output example

```
#exectime: 2018/07/10 18:31:57
#command: ajsreport -b 2018/07/01 -e 2018/07/07 -i 300
#DATE,RJ_EXEC_START_NUM,CONDRJ_MONITOR_START_NUM,CONDRJ_EV_DETECTED_NUM,.
..
2018/07/01 00:00,0,0,0,0,...
2018/07/01 05:00,0,0,0,0,...
      :      ,:,:,:,...
2018/07/07 21:00,0,0,0,0,...
```

Example 8

The following command outputs the operating status for the period from 2018/09/01 8:00 to 2018/9/15 17:30 at intervals of 2 hours (120 minutes).

The last row is less than the collection interval of 2 hours (120 minutes). Therefore, the command outputs the operating status for the period up to the end time of the collection range (in this case, 90 minutes from 16:00 on 2018-9-15).

```
ajsreport -b 2018/09/01 -s 8:00 -e 2018/9/15 -f 17:30 -i 120
```

Output example

```
#exectime: 2018/12/04 08:43:35
#command: ajsreport -b 2018/09/01 -s 8:00 -e 2018/9/15 -f 17:30 -i 120
#DATE,RJ_EXEC_START_NUM,CONDRJ_MONITOR_START_NUM,CONDRJ_EV_DETECTED_NUM,.
..
2018/09/01 08:00,0,0,0,...
2018/09/01 10:00,0,0,0,...
      :      ,:,:,:,...
2018/09/15 16:00,0,0,0,...
```

ajsrestore

Format

```
ajsrestore
  [-F service-name]
  [-b backup-information-directory-name]
  [-d restoration-destination-unit-name]
  [{-i|_e|-f}]
  [-t]
  [-S]
  -n backup-box-name
  [backup-file-name...]
```

Description

Restores a unit backed up to the backup box to the unit definition information directory.

Execution privileges

You must have any of the following JP1 privileges:

- JP1_AJS_Admin privilege
- JP1_AJS_Manager privilege
- JP1_AJS_Editor privilege

We recommend that the user who executes this command have administrator privileges (in Windows systems) or superuser privileges (in UNIX systems).

Arguments

-F *service-name*

Specify the name of the target scheduler service.

You can specify a character string of 1 to 30 bytes.

-b *backup-information-directory-name*

Specify the full path of the directory if you use a directory other than the backup information directory[#] specified at the time of configuration.

You can specify a character string of 1 to 255 bytes.

By default, the system assumes the backup information directory[#] specified at the time of configuration.

#

It refers to the directory name specified by the AJSBKUROOT environment setting parameter.

-d *restoration-destination-unit-name*

When restoring a unit backed up, specify a job group or jobnet name to be used in the restoration destination.

You can specify a character string of 1 to 899 bytes.

-i

If the restoration destination contains a unit having the same name as a unit to be restored, this option displays a message and a prompt for confirmation.

-e

An error occurs if the restoration destination contains a unit having the same name as a unit to be restored. No information is updated.

-f

Forcibly updates the unit even if the restoration destination contains a unit having the same name as a unit to be restored.

-t

Outputs a list of names of the units backed up in the backup box to the standard output file.

You can change the output format by setting the `AJSDISPSUBUNITTYPE` environment variable.

- When outputting a job group type
Set the `AJSDISPSUBUNITTYPE` environment variable to YES.

Note

A job group type is displayed only when the type of the saved unit is a job group.

- When not outputting a job group type
Select either of the following:
 - Set the `AJSDISPSUBUNITTYPE` environment variable to NO.
 - Specify no value for the `AJSDISPSUBUNITTYPE` environment variable.

For details about the `AJSDISPSUBUNITTYPE` environment variable, see [Table 1-5](#) in *1.4.1 Environment variables used to execute JP1/AJS3 commands*.

-s

Even for suspended jobnets that have been registered for execution, this option makes it possible to update the unit in these jobnets. Even for suspended jobnets, however, you cannot update definitions if any of the following situations occur:

- When the definition of the root jobnet is being updated
- When the definitions of job groups containing the definition of the root jobnet are being updated
- When jobnets are being executed

-n *backup-box-name*

Specify a backup box name.

You can specify a character string of 1 to 50 bytes.

The name of the backup box depends on the file system of your operating system. It is case-sensitive if you are using UNIX and case-insensitive if you are using Windows.

backup-file-name

Specify the name of a file to be restored in the backup box.

You can specify a value from 0001 to 1024.

You can specify multiple backup file names.

If you omit this option, all the backup files in the backup box are restored.

Notes

- Either of the following users can restore a unit:
 - A user who has the update privilege for the unit to be restored
 - A JP1 user mapped to the OS user who has Administrators or superuser privileges

Note, however, that if `yes` is set after changing the `ADMACLIMIT` environment setting parameter from its default, even a JP1 user who was mapped to an OS user with Administrators or superuser privileges must have the update privilege.
- You cannot restore the unit in the following cases:
 - You do not have the reference privilege for both the backup box and backup file.
 - The restoration destination contains no units.
 - Restoration would result in an invalid hierarchical structure, such as restoring a job group in a jobnet.
 - The number of nests in the job group or jobnet exceeds 30 (10 if the `DEFLENTYPE` environment setting parameter is set to `sjis`), the maximum allowed.
- If the restoration destination contains a unit having the same name as a unit to be restored, delete that unit before attempting to restore a unit.
- Before restoring a root jobnet registered for execution and the job group or planning group containing the root jobnet, you must use the `ajsleave` command to cancel the registration (Otherwise, the restore process is not effective). For those units other than in the root jobnet, the job group containing the root jobnet, and the remote jobnet, however, specifying the `-s` option in this command while keeping the target jobnet suspended makes it possible to conduct the delete process without having to cancel the registered jobnet. (If the target unit is currently being executed, the delete process is not effective even if the `-s` option is specified.)
- This command terminates abnormally if the jobnet specified at the destination's unit is undergoing a suspended-state change.
- You cannot restore a planning group into a jobnet.
- You cannot restore any unit other than a jobnet or remote jobnet into a planning group.

Return values

| | |
|--|--------------|
| 0 | Normal end |
| Multiple of 4 within the range from 4 to 124 | Abnormal end |

Additional information

- If you omit a backup file name, the backup files are restored in the order in which they were created.
- The place where a recovered unit appears in the Jobnet Editor window of JP1/AJS3 - View is determined automatically. The unit with the same name appears in the same location as before restoration.

Example 1

The following command forcibly restores all the backup files saved in backup box `BOX1` to job group `/Materials/ShipManagement` although it contains a unit having the same name as the unit to be restored.

```
ajsrestore -f -d /Materials/ShipManagement -n BOX1
```

Example 2

The following command outputs a list of the units (jobnets) saved in backup box BOX1.

```
ajsrestore -t -n BOX1
```

Output example:

```
0001:/Materials:Template:g  
0002:/Materials/ShipManagement:ShipSlipCreation:n
```

Example 3

The following command outputs a list of the units (jobnet connectors) saved in backup box BOX1.

```
ajsrestore -t -n BOX1
```

Output example

```
0001:/Materials:Template:g  
0002:/Materials/ShipManagement/ShipSlipCreation:JobnetExecutionWait:nc
```

ajsrgexport

Format

```
ajsrgexport
  [-F service-name]
  [-R]
  [-e {s|f}]
  [-o file-of-registered-execution-schedule-information-for-jobnet-name]
  [-m]
  unit-name...
```

Description

The `ajsrgexport` command exports registered execution-schedule information about the root jobnet registration for execution.

Execution privileges

You must have any of the following JP1 privileges:

- JP1_AJS_Admin privilege
- JP1_AJS_Manager privilege
- JP1_AJS_Editor privilege
- JP1_AJS_Operator privilege
- JP1_AJS_Guest privilege

Arguments

-F *service-name*

Specify the name of the target scheduler service.

You can specify a character string of 1 to 30 bytes. If you omit this option, the system assumes the default scheduler service name.

-R

If this option is specified, all root jobnets included in the specified units, in addition to the specified units themselves, are subject to exporting.

-e {*s*|*f*}

Specify the execution registration type or types of jobnets for which you want to export registered execution-schedule information.

- *s*
The command exports registered execution-schedule information about root jobnets that have been registered for planned execution.
- *f*
The command exports registered execution-schedule information about root jobnets that have been registered for fixed execution.

If you want to export registered execution-schedule information about root jobnets that have been registered for planned execution and also root jobnets that have been registered for fixed execution, specify `-e sf`.

If you omit this option, the command exports information about root jobnets that have been registered for planned execution and also root jobnets that have been registered for fixed execution.

If no root jobnets have been registered for the specified type of execution or if the specified root jobnets will no longer be executed, a message to that effect is output.

You can suppress this message output by specifying the `-m` option.

-m

Specify this option if you do not want a message to be output.

-o file-of-registered-execution-schedule-information-for-jobnet-name

Specify the name of the file to which registered execution-schedule information will be exported.

You can specify a character string of 1 to 255 bytes. If the length of the specified file name exceeds 255 bytes, an error message is output. If this option is omitted, the registered execution-schedule information is output to the standard output file. If the name of an existing file is specified, the existing file is overwritten.

Please do not modify this file. If a modified file is imported, the system might be unable to operate correctly.

unit-name . . .

Specify the names of root jobnets or job groups to be exported. The maximum total length of the names is 930 bytes.

Note that you can specify scheduler service names but cannot specify host names and execution IDs.

Return values

| | |
|--|--------------|
| 0 | Normal end |
| Multiple of 4 within the range from 4 to 124 | Abnormal end |

Notes

- Either of the following users can execute this command:
 - A user who has the reference privilege for the unit to be exported
 - A JP1 user mapped to the OS user who has Administrators or superuser privilegesNote, however, that if `yes` is set after changing the `ADMACLIMIT` environment setting parameter from its default, even a JP1 user who was mapped to an OS user with Administrators or superuser privileges must have the reference privilege.
- This command can export registered execution-schedule information about only root jobnets that have been registered for planned or fixed execution.
- This command cannot be executed remotely.
- If there is no information to be exported, the command outputs the following message: `KAVS4837-I There is no information to be exported.`
- Do not export or import registered execution-schedule information between systems that use different time zones. Before you execute the `ajsrgeexport` or `ajsrgeimport` commands, make sure that the time zone settings on the systems on which you execute these commands are the same.

- If the target root jobnet is or contains a release target jobnet (a root jobnet for which release entry is made), and has been registered for fixed execution, the data to be exported changes on the release date. On and after the release date, the new jobnet definition (the definition of the release-source jobnet) is exported.
- For details about how to back up and recover the execution registration status, see *3.4 Backing up and recovering the execution registration status of jobnets by using the ajsrgexport and ajsrgimport commands in the JPI/Automatic Job Management System 3 Administration Guide*.

Example 1

The following command exports registered execution-schedule information about the root jobnets in job group /GROUPA.

```
ajsrgexport -F AJSROOT1 -o /tmp/unitreg.txt /GROUPA/*
```

Example 2

The following command exports registered execution-schedule information about root jobnet /GROUPA/JOBNETA only.

```
ajsrgexport -F AJSROOT1 -o /tmp/unitreg_net.txt /GROUPA/JOBNETA
```

Example 3

The following command exports registered execution-schedule information about the root jobnets in job group /GROUPA.

```
ajsrgexport -F AJSROOT1 -R -o /tmp/unitreg_net.txt /GROUPA
```

ajsgimport

Format

```
ajsgimport
  [-F service-name]
  [-f]
  [-h]
  [-c]
  [-u unit-name]
  [-o unit-name]
  -i file-of-registered-execution-schedule-information-for-jobnet-name
```

Description

The `ajsgimport` command imports jobnet registered execution-schedule information, and registers root jobnets for execution based on the imported information.

Execution privileges

You must have any of the following JP1 privileges:

- JP1_AJS_Admin privilege
- JP1_AJS_Manager privilege
- JP1_AJS_Operator privilege

Arguments

-F *service-name*

Specify the name of the target scheduler service.

You can specify a character string of 1 to 30 bytes. If you omit this option, the system assumes the default scheduler service name.

-f

Specify this option if you do not want to execute jobnets that have been scheduled for execution on the current day and the execution time has already passed. This option is valid for all jobnets specified in the file of registered execution-schedule information for jobnets regardless of whether the type of execution registration is planned execution or fixed execution.

-h

Holds execution of root jobnets when they are registered for execution based on the imported information.

When the command imports jobnets registered for planned execution or fixed execution, execution of only the first execution generation is held among generations created when jobnets are registered for execution. For generations to be held, the specification of this option takes precedence over the hold-release information in the file of registered execution-schedule information for jobnets.

If jobnets registered for planned execution with the hold attribute set[#] are exported by the `ajsgexport` command and then imported by the `ajsgimport` command, the first execution generation after the import is not held. If you want to hold the first execution generation after the import, specify the `-h` option in the `ajsgimport` command.

If jobnets registered for fixed execution with the hold attribute set[#] are exported by the `ajsrsexport` command and then imported by the `ajsrimport` command, the execution schedule after the execution date of the `ajsrimport` command is imported. This means that, depending on the exported execution schedule and the execution day of the `ajsrimport` command, the execution schedule with the hold attribute might or might not be imported. Specify the `-h` option for the `ajsrimport` command if you want to hold the first execution generation after importing the registered execution-schedule information, regardless of the value of the hold setting of exported execution schedule.

#

Jobnets registered for execution by using one of the following methods:

- Jobnets are registered for execution by using the `ajsenry` command with the `-h` option specified (including operations retried from the Temporary Changes dialog box of JP1/AJS3 - View).
- Registered execution-schedule information is imported by using the `ajsrimport` command with the `-h` option specified.
- In the Register for Execution dialog box of JP1/AJS3 - View or JP1/AJS3 - Web Console, the **Hold** check box is selected for **Holding**, and then jobnets are registered for execution.
- In the Add dialog box of JP1/AJS3 - View (for root jobnets), the **Hold** check box is selected for **Holding**, and then a fixed execution schedule is added.

-c

If an error occurs because a schedule cannot be created when the command is registering imported jobnets for execution, this option allows the command to continue if there is another root jobnet to be registered.

However, if the file specified for the `-i` option (that is, the file containing registered execution-schedule information for jobnets) contains invalid information, the system stops the execution of the command and terminates processing.

If you omit this option, the system stops the execution of the command and terminates processing when an error occurs.

-u *unit-name*

Specify the unit name of a root jobnet or job group you want to import. You can use a maximum of 930 bytes to specify the unit name. Note that you cannot use wildcard characters. Also, you cannot specify a scheduler service name, host name, or execution ID.

You can specify multiple `-u` options in the `-u unit-name -u unit-name ...` format.

If root jobnets that have the same name as the specified unit names are found in the registered execution-schedule information file, these root jobnets are registered for execution. Similarly, if root jobnets belonging to job groups that have the same name as the specified unit names are found in the registered execution-schedule information file, these root jobnets are registered for execution.

If you specify neither the `-o` option nor this option, registered execution-schedule information about all units specified in the file of registered execution-schedule information for jobnets specified in the `-i` option is imported.

You cannot specify the `-u` option together with the `-o` option.

-o *unit-name*

Specify the unit name of a root jobnet or job group you do not want to import. You can use a maximum of 930 bytes to specify the unit name. Note that you cannot use wildcard characters. Also, you cannot specify a scheduler service name, host name, or execution ID.

You can specify multiple `-o` options in the `-o unit-name -o unit-name ...` format.

If root jobnets that have the same name as the specified unit names are found in the registered execution-schedule information file, the other root jobnets are registered for execution. Similarly, if root jobnets belonging to job groups that have the same name as the specified unit names are found in the registered execution-schedule information file, the other root jobnets are registered for execution. If a specified unit name is not found in the file, this option is ignored.

If you specify neither the `-u` option nor this option, registered execution-schedule information about all units specified in the file of registered execution-schedule information for jobnets specified in the `-i` option is imported.

You cannot specify the `-o` option together with the `-u` option.

-i file-of-registered-execution-schedule-information-for-jobnet-name

Specify the name of the file to which registered execution-schedule information has been exported.

You can specify a character string of 1 to 255 bytes. If the length of the specified file name exceeds 255 bytes, the following message is output: KAVS4829-E Specified file name (*file-name*) is too long.

Return values

| | |
|--|--------------|
| 0 | Normal end |
| Multiple of 4 within the range from 4 to 124 | Abnormal end |

Notes

- Either of the following users can execute this command:
 - A user who is the same JP1 user as the export JP1 user and who has the operation privilege for the units that are in the root jobnet to be imported and that are coded in the registered execution-schedule information file
 - A JP1 user mapped to the OS user who has Administrators or superuser privileges

Note, however, that if `yes` is set after changing the `ADMACLIMIT` environment setting parameter from its default, even a JP1 user who was mapped to an OS user who has Administrators or superuser privileges must have the operation privilege.
- When fixed execution of the root jobnet is performed by multiple users, only the JP1 user who is mapped to an OS user with Administrators or superuser privileges can execute this command. Note, however, that if `yes` is set after changing the `ADMACLIMIT` environment setting parameter from its default, even a JP1 user who was mapped to an OS user who has Administrators or superuser privileges must have the operation privilege.

If a JP1 user who cannot execute the `ajsgimport` command performs import, the KAVS4824-E message appears, and registered execution-schedule information cannot be imported.
- You can import registered execution-schedule information about only root jobnets registered for planned or fixed execution.
- You cannot execute this command remotely.
- Do not export and import registered execution-schedule information between systems that use different time zones. Before you execute the `ajsgexport` or `ajsgimport` commands, make sure that the time zone settings on the systems on which you execute these commands are the same.
- For details about how to back up and recover the execution registration status, see *3.4 Backing up and recovering the execution registration status of jobnets by using the `ajsgexport` and `ajsgimport` commands* in the *JP1/Automatic Job Management System 3 Administration Guide*.

Example 1

The following command imports all contents of the file of registered execution-schedule information for jobnets.

```
ajsgimport -F AJSROOT1 -i unitreg.txt
```

Example 2

The following command imports information about a specific unit (/GROUPA/JOBNETA) specified in the file of registered execution-schedule information for jobnets.

```
ajsgimport -F AJSROOT1 -i unitreg.txt -u /GROUPA/JOBNETA
```

ajsschedule

Format

```
ajsschedule
  [-F service-name]
  -b [[year/]month/]day
  -e [[year/]month/]day
  root-jobnet-name
```

Description

Creates a jobnet execution schedule for a certain period. The result of the creation is output to the standard output file according to the format of the schedule information parameter. For details about the schedule information parameter, see [5.4 Creating a schedule information file](#).

Execution privileges

You must have any of the following JP1 privileges:

- JP1_AJS_Admin privilege
- JP1_AJS_Manager privilege
- JP1_AJS_Editor privilege
- JP1_AJS_Operator privilege
- JP1_AJS_Guest privilege

Arguments

-F *service-name*

Specify the name of the target scheduler service.

You can specify a character string of 1 to 30 bytes.

-b [[*year/*]*month/*]*day*

Specify the start date of the period applied to a schedule to be created.

The start time is the base time.

- *year*
You can specify a value between 1994 and 2099 for the year.
- *month*
You can specify a value between 1 (or 01) and 12.
- *day*
You can specify a value between 1 (or 01) and 31.

If you omit the year or the year/month in this option, the following values are assumed.

year: Year when the command was executed

year/month: Year and month when the command was executed

-e [[year/] month/] day

Specify the end date of the period applied to a schedule to be created. The end date must be the same as or follow the start date.

The end time is the base time plus 23 hours: 59 minutes: 59 seconds.

- *year*
You can specify a value between 1994 and 2099 for the year.
- *month*
You can specify a value between 1 (or 01) and 12.
- *day*
You can specify a value between 1 (or 01) and 31.

If you omit the year or the year/month in this option, the following values are assumed.

year: Year when the command was executed

year/month: The year and month in which you executed the command

root-jobnet-name

Specify the name of a target root jobnet by using a maximum of 930 bytes.

Note that you cannot use wildcard characters to create an execution schedule for multiple root jobnets. If you specify a character string that includes a wildcard character and the specification can represent multiple root jobnets, an execution schedule is created for only one root jobnet.

Also note that you cannot specify a logical host name or execution ID for *root-jobnet-name*.

Notes

- Either of the following users can create an execution schedule:
 - A user granted the reference privilege when the jobnet was defined or when its attributes were changed
 - A JP1 user mapped to the OS user who has Administrators or superuser privilegesNote, however, that if *yes* is set after changing the *ADMACLIMIT* environment setting parameter from its default, even a JP1 user who was mapped to an OS user with Administrators or superuser privileges must have the reference privilege.
- The execution date can be specified in the *-b* or *-e* option. For the execution date, see *3.3.1 Time formats and schedule rules for root jobnets* in the manual *JP1/Automatic Job Management System 3 Overview*.
- If the 48-hour schedule is used for the schedule definition of a root jobnet, be careful with the base time. If the base time is not 0:00, for a root jobnet that will be executed across two days, the schedule information output by this command might be different from the schedule that is actually defined. For details about the execution date output by the command, see *3.3.1 Time formats and schedule rules for root jobnets* in the manual *JP1/Automatic Job Management System 3 Overview*. For the execution time of a nested jobnet, a time in the range from 0:00 to 23:59 is output, even if the jobnet is executed across two days. The concept of the base time is not necessary for a nested job because a nested job follows the root jobnet, which uses the base time for execution. For this reason, the 24-hour schedule is used for the execution time output for a nested job.
- If the specified root jobnet is a release target root jobnet (a root jobnet for which release entry has been made), the definition of the schedule to be created changes on the release date. On and after the release date, the new jobnet definition (the definition of the release-source jobnet) is applied.

Return values

| | |
|--|--------------|
| 0 | Normal end |
| Multiple of 4 within the range from 4 to 124 | Abnormal end |

Example

The following command creates the schedule of jobnet net1 for June 20XX.

```
ajsschedule -b 20XX/6/1 -e 20XX/6/30 /net1
```

Output example

```
PN=net1:20XX06050000:h:::::;  
{  
  PJ=job:y:y:h;  
}  
PN=net1:20XX06120000:h:::::;  
{  
  PJ=job:y:y:h;  
}  
PN=net1:20XX06190000:h:::::;  
{  
  PJ=job:y:y:n;  
}  
PN=net1:20XX06260000:h:::::;  
{  
  PJ=job:y:y:n;  
}
```

ajsshow

Format

```
ajsshow
  [-F service-name]
  [{-s|-p|_l|-xw [-xi {b|c}]|-r|-f "format-indicator"|
    -i "two-byte-format-indicator"}]
  [-t "format-indicator"]
  [-k]
  [-g {number-of-generations|a}
    |-b year/month[/day] [-e year/month[/day]]
    |-v year/month[/day] [-w year/month[/day]]
    |-B execution-registration-number]
  [-u user-name]
  [-c]
  [-R]
  [-E]
  [-T]
  [-N|-J]
  [-d [[year/]month/]day]
  [-h hours[:minutes]]
  [-X {yes|no|auto}]
  job-name-or-jobnet-name-or-job-group-name...
```

Description

Outputs the results of the past execution, the current status, the next execution schedule, and other information on a jobnet or job already registered for execution to the standard output file. (For details about the output format, see [Additional information 1](#) later.)

Execution privileges

You must have any of the following JP1 privileges:

- JP1_AJS_Admin privilege
- JP1_AJS_Manager privilege
- JP1_AJS_Editor privilege
- JP1_AJS_Operator privilege
- JP1_AJS_Guest privilege

Arguments

-F *service-name*

Specify the name of the target scheduler service.

You can specify a character string of 1 to 30 bytes.

-s

Outputs execution registration information scheduled to be performed in the specified jobnet in the next cycle.

If there is nothing scheduled for subsequent execution, the option outputs the execution registration information for the jobnet that was executed in the previous cycle or is currently being executed.

Note that for a jobnet that has been registered for planned execution, if the next execution is not scheduled, a non-scheduled generation is generated for the next execution. Therefore, if you specify this option when the next execution is not scheduled, `Not sched. to exe.` is output as the status.

When you use the function that automatically selects a unit being operated, select a jobnet scheduled to be executed in the next cycle from those in the root jobnet under the planning group, and output the execution registration information. If there is nothing scheduled for subsequent execution, the option selects the jobnet that was executed in the previous cycle or is currently being executed and outputs the execution registration information.

You cannot specify this option for a job.

You cannot specify this option with the `-p`, `-l`, `-xw`, `-r`, `-f`, `-i`, `-g`, `-b`, `-e`, `-v`, `-w`, `-B`, or `-J` option.

You cannot specify this option if you specify the execution ID for a job, jobnet, or job group name.

-p

Outputs information on the next execution schedule of a specified jobnet.

If you are using the function for automatically selecting a target unit, the command outputs information on the next execution schedule of the jobnet scheduled to be executed next under the root jobnets in a planning group.

You cannot specify this option for a job.

You cannot specify this option with the `-s`, `-l`, `-xw`, `-r`, `-f`, `-i`, `-g`, `-b`, `-e`, `-v`, `-w`, `-B`, or `-J` option.

You cannot specify this option if you specify the execution ID for a job, jobnet, or job group name.

-l

Outputs execution result information on a specified jobnet, and jobs and jobnets in it.

If you are using the function for automatically selecting a target unit, the command outputs result information for the jobnets or jobs that belong to as many generations as the number specified with the `-g` option, starting from generation number 1, under the root jobnets in a planning group.

You cannot specify this option with the `-s`, `-p`, `-xw`, `-r`, `-f`, `-i`, `-b`, `-e`, `-v`, `-w`, or `-B` option.

You cannot specify this option if you specify the execution ID for a job, jobnet, or job group name.

-xw

Outputs the status of the specified unit with wait conditions and the units whose ends are being waited for. Information about the units whose ends are being waited for relates to the generation whose end is currently being waited for.

When a jobnet with start conditions for which wait conditions are set is to be output, specify `c` for the `-xi` option. If a jobnet with start conditions for which wait conditions are set is output without `c` being specified for the `-xi` option, the `ajsshows` command ends abnormally. For details, see the `-xi` option.

For details about checking units whose ends are being waited for, see 2.2.5(8) *Checking units whose ends are being waited for* in the *JP1/Automatic Job Management System 3 System Design (Work Tasks) Guide*.

If you are using the function for automatically selecting a target unit, the command outputs results for a number of generations of jobnets or jobs equivalent to the number specified with the `-g` option, starting from generation number 1, under the root jobnets in a planning group.

You cannot specify this option together with the `-l`, `-s`, `-p`, `-r`, `-f`, `-i`, `-b`, `-e`, `-v`, or `-w` option.

This option is only available when the database uses a standard configuration.

If you specify an execution ID in the `-B` option or as the unit name, the command outputs information only for that generation.

If you specify a value of 1 or greater for the `-g` option, the command outputs information for a number of generations of jobnets or jobs equivalent to the number specified with the `-g` option, starting from generation 1. If generation 1 does not exist, the command outputs information for generation 0.

If you specify 0 in the `-g` option, the command outputs results for generation 0.

If you omit the `-B` option, an execution ID, and the `-g` option, the system assumes 1 as the value of the `-g` option.

-xi {b|c}

Specify the output format of wait information. Specify this option together with the `-xw` option. If it is omitted, `b` is assumed.

When a jobnet with start conditions for which wait conditions are set is to be output, the generation to be output (monitoring generation or execution generation) differs depending on the specification (`b` or `c`).

- `b`
 Outputs information about the units with wait conditions or the information set as a wait condition. Note, however, that settings information for **A jobnet with start conditions is waiting** is not output.
 To output a jobnet with start conditions, output both monitoring and execution generations. Note, however, that if the execution generation does not have wait information, the `ajsshows` command ends abnormally.
- `c`
 Information about units with wait conditions or the information set as wait conditions are output. Settings information for **A jobnet with start conditions is waiting** is also output.
 When a jobnet with start conditions is to be output, only the monitoring generation is output. The execution generations are not output. If you use the `-g` option to output only the execution generations, the `ajsshows` command ends abnormally.

The following table describes the differences between generations that are output according to the argument of the `-xi` option.

Table 3–19: Differences between the generations that are output according to the argument specified for the `-xi` option

| No. | -xi option argument | How generations are specified | Jobnet generation where a start condition is used | | Jobnet generation where no start condition is used |
|-----|---------------------|---|---|----------------------|--|
| | | | Monitoring generation | Execution generation | |
| 1 | b | Execution ID or execution registration number | Y | E | Y |
| 2 | | -g option | Y | E | Y |

| No. | -xi option argument | How generations are specified | Jobnet generation where a start condition is used | | Jobnet generation where no start condition is used |
|-----|---------------------|---|---|----------------------|--|
| | | | Monitoring generation | Execution generation | |
| 3 | c | Execution ID or execution registration number | Y | N | Y |
| 4 | | -g option | Y | N or E [#] | Y |

Legend

Y: Information is subject to output, and is output.

N: Information is not subject to output

E: Information is subject to output, but the `ajsshows` command ends abnormally.

#

If the `-g` option is used to include all generations, information is not to be output. If the `-g` option is used to output the execution generation only, the `ajsshows` command ends abnormally.

For output examples of the `-xi` option, see [Example 8](#).

-r

Outputs the standard error output file name for a specified job.

If the specified job does not send information to the standard error output, the default standard error output file name is output.

If an external database is used, a standard error output file is created in the directory specified for the `STDFILEOUTDIR` environment setting parameter, and the file name is output to the standard output.

You cannot specify this option with the `-s`, `-p`, `-l`, `-xw`, `-f`, `-i`, `-T`, or `-N` option.

-f "format-indicator"

Outputs the information specified by the format indicator for a specified jobnet or job.

Specify the format indicator by `%` followed by an alphabetic character of one byte. For details about the format indicator, see [Additional information 1](#) later.

Characters are output as specified, except for the format indicator enclosed in double quotation marks (`"`).

-i "two-byte-format-indicator"

Outputs the information specified by the format indicator for a specified jobnet or job.

Specify the format indicator by `%` followed by an alphabetic character of two bytes. For details about the format indicator, see [Additional information 1](#) later.

Characters are output as specified, except for the format indicator enclosed in double quotation marks (`"`).

-t "format-indicator"

Outputs the information specified by the format indicator to the title row.

Specify the format indicator by % followed by an alphabetic character of one byte. For details about the format indicator, see *Additional information 1* later.

Characters are output as specified, except for the format indicator enclosed in double quotation marks (").

You must specify this option with the `-f` or `-i` option. Specify this option with the `-f` option. If you specify it with the `-s`, `-p`, `-l`, `-xw`, or `-k` option, it is disabled.

-k

Does not output the title row.

When you specify this option with the `-s`, `-p`, `-l`, or `-xw` option, only the `AJSPATH=` row is output.

-g {number-of-generations | a}

Outputs execution result information in descending order from the latest generation to the specified generation.

The default is 1. However, even when you specify 1 for *number-of-generations*, if generation number 1 does not exist, 0 is assumed as the number of generations.

If you are using the function for automatically selecting a target unit, the command outputs information about the jobnets or jobs that belong to as many generations as the specified number, starting from generation number 1 or 0, under the root jobnets in a planning group.

You cannot specify this option with the `-s`, `-p`, `-b`, `-e`, `-v`, `-w`, or `-B` option.

- *number-of-generations*

You can specify 0 to 99 generations. You can, however, enable the system setting option to expand the number of generations up to 999.

If you set 0, the system outputs information on the jobnets not executed and jobnets being held (in this case, you cannot specify this option with the `-l` option).

Even though a nest jobnet is not executed or is being held, the number of generations is assumed to be 1 if its root jobnet is being executed.

If the number of generations is other than 0, the generation number is output to the title row when you specify the `-l` option.

- a

Outputs execution result information on all the generations.

When you execute this command for a unit that has never been executed, the results of generation 0 are output. When you execute this command for a unit that has already been executed, the results of generation 1 or greater are output.

-b year/month[/day]

Specify the start date of the period of information output as a calendar date.

The start time is the base time.

- *year*

You can specify a value between 1994 and 2099 for the year.

- *month*

You can specify a value between 1 (or 01) and 12.

- *day*

You can specify a value between 1 (or 01) and 31. If you omit this option, the system assumes the base date for the specified year and month.

Specify the end date of the information output period in the `-e` option.

The command outputs information for specified units that have results or have schedule information in the period from the start date to the end date.

If the specified unit has no result or no schedule information in the period from the start date to the end date, the command does not output information.

If you are using the function for automatically selecting a target unit, the command outputs information about the units having result or schedule information for the specified period under the jobnets in a planning group.

Specify this option together with the `-f` or `-i` option. You cannot specify it with the `-s`, `-p`, `-l`, `-xw`, `-g`, `-v`, `-w`, or `-B` option.

See the usage examples below for details on how to use this option.

`-e year/month [/day]`

Specify the end date of the period of information output as a calendar date.

For the end date, specify a date the same as or following the start date.

If you omit this option, the system assumes the date specified with the `-b` option.

The end time is the base time plus 23 hours: 59 minutes: 59 seconds.

- *year*
You can specify a value between 1994 and 2099 for the year.
- *month*
You can specify a value between 1 (or 01) and 12.
- *day*
You can specify a value between 1 (or 01) and 31. If you omit this option, the system assumes the base date for the specified year and month. (For example, if you set the base date to 20, the system assumes 19 as the end date.)

Specify this option with the `-f` or `-i` option and the `-b` option. You cannot specify it with the `-s`, `-p`, `-l`, `-xw`, `-g`, `-v`, `-w`, or `-B` option.

`-v year/month [/day]`

Specify the start date of the period of information output as an execution date.

The start time is the base time.

- *year*
You can specify a value between 1994 and 2099 for the year.
- *month*
You can specify a value between 1 (or 01) and 12.
- *day*
You can specify a value between 1 (or 01) and 31. If you omit this argument, the system assumes the base date in the specified month and year.

The command outputs information for specified units whose root jobnets have results or have schedule information in the period from the start date to the end date.

If results or schedule information exists for the upper-level root jobnet in the period from the start date to the end date, but none exists for the specified unit in the period specified by the `-v` and `-w` options, the command outputs information for all units (including unscheduled units) defined under the specified unit.

If you are using the function for automatically selecting a target unit, the command outputs information about the units having result or schedule information for the specified period under the jobnets in a planning group.

Specify this option together with the `-f` or `-i` option. You cannot specify it with the `-s`, `-p`, `-l`, `-xw`, `-g`, `-b`, `-e`, or `-B` option.

See the usage examples below for details on how to use this option.

`-w year/month [/day]`

Specify the end date of the period of information output as an execution date.

For the end date, specify a date the same as or following the start date.

If you omit this option, the system assumes the date specified with the `-v` option.

The end time is the base time plus 23 hours: 59 minutes: 59 seconds.

- *year*
You can specify a value between 1994 and 2099.
- *month*
You can specify a value between 1 (or 01) and 12.
- *day*
You can specify a value between 1 (or 01) and 31. If you omit this option, the system assumes the base date for the specified year and month. (For example, if you set the base date to 20, the system assumes 19 as the end date.)

Specify this option with the `-f` or `-i` option and the `-v` option. You cannot specify it with the `-s`, `-p`, `-l`, `-xw`, `-g`, `-b`, `-e`, or `-B` option.

`-B execution-registration-number`

Specify the execution registration number of the jobnet whose information you want to display in the `YYYYMMDDNNN` format. The following gives the contents of `YYYYMMDDNNN`.

YYYY: Year of the date of execution

MM: Month of the date of execution

DD: Day of the date of execution

NNN: Execution registration sequence number for the date of execution

For details about the execution registration number, see *4.5.13 Methods of specifying generations when executing commands* in the manual *JP1/Automatic Job Management System 3 Overview*.

If you are using the function for automatically selecting a target unit, the command outputs information about the units having an execution registration number under the jobnets in a planning group.

You cannot specify this option with the `-s`, `-p`, `-l`, `-g`, `-b`, `-e`, `-v`, or `-w` option. Specify this option together with the `-f`, `-i`, `-r`, or `-xw` option.

-u *user-name*

To output information on a jobnet registered by a specified user, specify the user name.

You can specify a character string of 1 to 31 bytes.

-c

Obtains information for the specified jobnet or job, and then outputs it in the high-speed mode.

You cannot obtain information about a job or jobnet that is added while it is suspended.

Format indicators `%B`, `%b`, `%O`, and `%o` are displayed in the `****/**/****: **: **` or `****/**/****: **` format.

Format indicator `%a` is displayed in the `00:00:00` format.

Specify this option with the `-f`, `-i`, or `-r` option.

You cannot specify this option with the `-s`, `-p`, `-l`, `-xw`, `-b`, `-e`, `-v`, `-w`, or `-R` option. However, you can specify this option with the `-R` option if you also specify the `-T` option.

-R

Outputs information on all the jobnets or jobs contained in a specified unit.

If you specify this option with the `-E`, `-T`, `-N`, and/or `-J` options, the system outputs information on the jobnets or jobs according to the specification of each option.

-E

Outputs information on a jobnet already registered for execution.

-T

Outputs information on the root jobnet.

You cannot specify this option with the `-r` or `-J` option.

-N

Outputs information on a jobnet.

You cannot specify this option with the `-r` or `-J` option.

-J

Outputs information on a job.

You cannot specify this option with the `-s`, `-p`, `-T`, or `-N` option.

-d [[*year*/] *month*/] *day*

Specify the starting date for re-executing the root jobnet. Use this option when you specify the 2-byte format indicator `%ab` or `%an` for the `-i` option to obtain the estimated required time.

- *year*

You can specify a value between 1994 and 2099.

- *month*

You can specify a value between 1 (or 01) and 12.

- *day*

You can specify a value between 1 (or 01) and 31.

If you omit the specification of the year or both the year and month for this option, the system assumes the following values:

year: The year when the command was executed

year/month: The year and month in which you executed the command

By default, the system assumes the date on which you execute the command.

This option is invalid if you do not specify the 2-byte format indicator %ab or %an for the *-i* option.

You cannot specify this option with the *-s*, *-p*, *-l*, *-xw*, *-r*, *-f*, *-g*, *-B*, or *-c* option.

You must specify this option with the *-i* option and either the *-b* or *-v* option.

-h hours[:minutes]

Specify the starting time for re-executing the root jobnet. Use this option when you specify the 2-byte format indicator %ab or %an for the *-i* option to obtain the estimated required time.

- *hours*

You can specify a value between 0 (or 00) and 24.

- *minutes*

You can specify a value between 0 (or 00) and 59. If you do not specify a value, 0 is assumed.

By default, the system assumes the time at which you execute the command.

This option is invalid if you do not specify the 2-byte format indicator %ab or %an for the *-i* option.

You cannot specify this option with the *-s*, *-p*, *-l*, *-xw*, *-r*, *-f*, *-g*, *-B*, or *-c* option.

You must specify this option with the *-i* option and either the *-b* or *-v* option.

-X {yes|no|auto}

Specify whether to automatically select the current unit for operation from the units listed in a planning group. The units in the job group are not, however, automatically selected regardless of the specified value. You cannot omit a root jobnet name.

- *yes*

Specify this to automatically select a target unit.

When specifying a unit name in the command, omit a root jobnet name in a planning group.

- *no*

Specify this if you do not want to automatically select a target unit.

You must specify a unit for which the command will operate. You cannot omit a root jobnet name in a planning group.

- *auto*

Whether a target unit will automatically be selected depends on how the unit name is specified.

- If you want to automatically select a target unit
Specify a unit name without a root jobnet name in a planning group.
- If you do not want to automatically select a target unit
Specify a unit name with a root jobnet name in a planning group. The command will operate for the specified unit only. However, if there is a unit having the same name as the path name specified without a root jobnet name in a planning group, a root jobnet name is assumed to be omitted so that a target unit will be selected automatically.

job-name-or-jobnet-name-or-job-group-name

Specify the name of the job or jobnet whose information you want to output. You can also specify a job, jobnet, or job group name with the `-R`, `-E`, `-T`, `-N`, or `-J` option.

You can specify a character string of 1 to 930 bytes.

You can specify more than one job, jobnet, or job group name. You cannot specify a manager job group name or manager jobnet name.

You can specify a logical host name or execution ID as a job, jobnet or job group name. If you specify an execution ID, however, the `-g`, `-b`, `-e`, `-v`, `-w`, and `-B` options are disabled.

To specify an execution ID as a job, jobnet or job group name, also specify the `-f`, `-i`, `-r`, or `-xw` option. You cannot specify the execution ID with the `-s`, `-p`, or `-l` (default) option. For details about how to specify the execution ID, see [1.1 Command syntax](#).

Notes

- When extracting data from the output information, extract the data based on its delimiting spaces, not by fixed byte count.
- Either of the following users can output unit information:
 - A user granted the reference privilege when the unit whose information is to be output was defined or when its attributes were changed
 - A JP1 user mapped to the OS user who has Administrators or superuser privileges
Note, however, that if `yes` is set after changing the `ADMACLIMIT` environment setting parameter from its default, even a JP1 user who was mapped to an OS user with Administrators or superuser privileges must have the reference privilege.
- The period of information output can be specified through a combination of the `-b` and `-e` options or the `-v` and `-w` options. Such different combinations give different output results. For details, see [Example 5](#).
- If you use the `-b`, `-e`, `-v`, or `-w` option to set the period of information output, the information is output in ascending order starting from the oldest generation.
- Information about a unit added to a suspended root jobnet is not output until the root jobnet is released from suspension. After the root jobnet is released from suspension, simulated results are output. Therefore, the results output when the root jobnet is suspended are different from the results output after the root jobnet is released from suspension.
- You may specify multiple units with the `-c` option and the `-g` option that specifies the number of generations. In this case, the system outputs execution result information on each jobnet or job in descending order from the latest generation to the specified generation.
- When you specify that a target unit automatically be selected from the units in a planning group, an error occurs if you do not have the appropriate operation privilege for the automatically selected unit.

- When the `-X` option is omitted, a target unit in a planning group is determined according to the value specified for the `AJSAUTOJUDGE` environment variable.
- For an explanation of how to specify the name of a unit in a planning group, see *Additional information in `ajsplan` in 3. Commands Used for Normal Operations.*
- If you specify none of the `-s`, `-p`, `-r`, `-f`, and `-i` options, the `-l` option is assumed.
- If you specify the `-l`, `-r`, `-f`, or `-i` option without specifying the `-g`, `-b`, `-e`, `-v`, `-w`, or `-B` option or execution ID, the system assumes `-g 1`.
- If you specify the `-b`, `-e`, `-v`, or `-w` option, a schedule simulation and an execution simulation are performed. When you specify `-g` (default), `-B`, or an execution ID, no simulation is performed. For details about simulations, see 4.4.2 *Simulation in the manual JP1/Automatic Job Management System 3 Overview.*
- If the `-r`, `-f %r`, or `-i %so` option is specified during external database connection, a standard output file or standard error output file is created. The update permission for these files is set to the user who executes the command. When a file is created, any existing file that has the same name as the file being created is deleted. If the specified job does not send information to the standard error output, a file is not created but the assumed standard error output file name is output to the standard output. The command terminates abnormally in the following cases:
 - The user who executed the command does not have access permissions for the directory specified for the `STDFILEOUTDIR` environment setting parameter.
 - The directory specified for the `STDFILEOUTDIR` environment setting parameter does not exist.
 - No directory is specified for the `STDFILEOUTDIR` environment setting parameter.
- The `ajsshows` command outputs calendar-based date and time information. Therefore, even if a 48-hour schedule is set for the root jobnet by using the `ROOTJOBNETSCHEDULERANGE` environment setting parameter, a time at or after 24:00 will be output as a time on the next day.
- Changing the generation number might not have completed immediately after starting execution of a generation. Therefore, if you specify the `-g` option, the command might not be able to output generation information as intended immediately after starting execution of a generation. In such a case, consider specifying the `-B` option or execution ID instead of the `-g` option. If you want to obtain information about the generation of a job that has started, you can specify the execution ID by using the `AJSEXECID` environment variable. For details about the `AJSEXECID` environment variable, see 1.4.2 *Environment variables set when a job is executed from JP1/AJS3.*

Arguments that can be specified when executing the command from JP1/AJS3 - View

You can specify the following arguments when executing the `ajsshows` command from JP1/AJS3 - View:

| No. | Arguments | Required? |
|-----|---|-----------|
| 1 | <code>-F service-name</code> | Y |
| 2 | <code>-s</code> | -- |
| 3 | <code>-p</code> | -- |
| 4 | <code>-l</code> | -- |
| 5 | <code>-xw</code> | -- |
| 6 | <code>-xi {b c}</code> | -- |
| 7 | <code>-r</code> | -- |
| 8 | <code>-f "format-indicator"</code> | -- |
| 9 | <code>-i "two-byte-format-indicator"</code> | -- |

| No. | Arguments | Required? |
|-----|---|-----------|
| 10 | -t "format-indicator" | -- |
| 11 | -k | -- |
| 12 | -g {number-of-generations a} | -- |
| 13 | -b year/month [/day] | -- |
| 14 | -e year/month [/day] | -- |
| 15 | -v year/month [/day] | -- |
| 16 | -w year/month [/day] | -- |
| 17 | -B execution-registration-number | -- |
| 18 | -u user-name | -- |
| 19 | -c | -- |
| 20 | -R | -- |
| 21 | -E | -- |
| 22 | -T | -- |
| 23 | -N | -- |
| 24 | -J | -- |
| 25 | -d [[year/]month/]day | -- |
| 26 | -h hours[:minutes] | -- |
| 27 | -X {yes no auto} | -- |
| 28 | job-name-or-jobnet-name-or-job-group-name | Y |

Legend:

Y: Required

--: Optional

You cannot specify any other options when executing the `ajslogprint` command from JP1/AJS3 - View.

For details about how to execute JP1/AJS3 commands from JP1/AJS3 - View, see *10.4 Executing JP1/AJS3 commands from JP1/AJS3 - View* in the *JP1/Automatic Job Management System 3 Operator's Guide*.

Return values

| | |
|--|--------------|
| 0 | Normal end |
| Multiple of 4 within the range from 4 to 124 | Abnormal end |

Additional information 1

[Table 3-20](#) lists the format indicators to output jobnet and job definitions.

[Table 3-21](#) lists the two-byte format indicators to output jobnet and job definitions.

[Table 3-22](#) lists the other format indicators.

[Table 3-23](#) provides the output formats of the format indicators.

Table 3–20: Format indicators for jobnet and job output.

| Format indicator | Output information | -f | -t |
|------------------|---|-----|-----|
| %J | Jobnet or job full-path name | Yes | Yes |
| %j | Jobnet or job name Character string of up to 30 bytes | Yes | Yes |
| %A | Character string specified for AJSPATH= Character string specified with %J except the part that follows the right-most slash (/) | Yes | Yes |
| %T | Unit type mgrou: Manager job group group: Job group mnet: Manager jobnet condn: Start condition (. CONDITION) net: Jobnet rnet: Jobnet for recovery rmnet: Remote jobnet rrnet: Remote jobnet for recovery job: Unix job rjob: Unix job for recovery pjob: PC job rpjob: PC job for recovery qjob: QUEUE job rqjob: QUEUE job for recovery jdjob: Judgment job rjdjob: Judgment job for recovery orjob: OR job rorjob: OR job for recovery cmsjb: OpenView status report job rcmsjb: OpenView status report job for recovery evwjb: JP1 event reception monitoring job revwjb: JP1 event reception monitoring job for recovery flwjb: File monitoring job rflwjb: File monitoring job for recovery mlwjb: Email reception monitoring job rmlwjb: Email reception monitoring job for recovery mqwjb: Message queue reception monitoring job rmqwjb: Message queue reception monitoring job for recovery mswjb: MSMQ reception monitoring job rmswjb: MSMQ reception monitoring job for recovery lfwjb: Log file monitoring job rlfwjb: Log file monitoring job for recovery ntwjb: Windows event-log monitoring job rntwjb: Windows event-log monitoring job for recovery tmwjb: Execution interval control job rtmwjb: Execution interval control job for recovery evsjb: JP1 event sending job revsjb: JP1 event sending job for recovery mlsjb: Email sending job rmlsjb: Email sending job for recovery mqsjb: Message queue sending job rmqsjb: Message queue sending job for recovery mssjb: MSMQ sending job | Yes | Yes |

| Format indicator | Output information | -f | -t |
|------------------|--|----------------------------|-----|
| %T | rmssjb: MSMQ sending job for recovery pwljb: Local power control job rpwljb: Local power control job for recovery pwrjb: Remote power control job rpwrjb: Remote power control job for recovery cuujb: Custom Unix job rcuujb: Custom Unix job for recovery cupjb: Custom PC job rcupjb: Custom PC job for recovery netcn: Jobnet connector fxjob: Flexible job rfxjob: Flexible job for recovery htpjb: HTTP connection job rhtpjb: HTTP connection job for recovery cewjb: Custom event job rcewjb: Custom event job for recovery | Yes | Yes |
| %C | Jobnet or job status ^{#30} | Yes ^{#10} | -- |
| %U | User name of a jobnet registered for execution Character string of up to 31 bytes | Yes ^{#9} | -- |
| %D | Time when the jobnet was registered for execution ^{#7} | Yes ^{#9} | -- |
| %L | Number of jobnet nests with respect to the root jobnet as 0 | Yes ^{#9} | Yes |
| %P ^{#3} | Whether the next execution is scheduled exist none | Yes ^{#27} | -- |
| %P ^{#3} | Date and time of the next execution schedule ^{#7} | Yes ^{#1} | -- |
| %M ^{#3} | Next execution method schedule plan shift | Yes ^{#1} | -- |
| %R | Return value or signal code * * * if there is no return value or signal code | Yes ^{#2} | -- |
| %S | Date and time when jobnet execution is started or when a job is submitted ^{#7} | Yes ^{#12} | -- |
| %s | Date and time when jobnet execution is started or when a job is submitted ^{#7} | Yes ^{#12} | -- |
| %K | Date and time when jobnet re-execution is started ^{#7} | Yes ^{#1} , #15 | -- |
| %k | Date and time when jobnet re-execution is started ^{#7} | Yes ^{#1} , #15 | -- |
| %E | Date and time when jobnet or job execution is ended ^{#7} | Yes | -- |
| %e | Date and time when jobnet or job execution is ended ^{#7} | Yes | -- |
| %V | Date and time when jobnet or job execution is started in another host ^{#7} | Yes ^{#2} | -- |
| %Q | Date and time when jobnet or job execution was ended in another host ^{#7} | Yes ^{#2} | -- |
| %W | \$LANG value | Yes ^{#9} | Yes |

| Format indicator | Output information | -f | -t |
|------------------|---|----------------------------------|-------------------|
| %Z | \$TZ value | Yes ^{#9} | Yes |
| %G | Generation number ^{#8} (0 or less for scheduled generations) (1 or greater for generations being executed or execution result generations) | Yes ^{#8} | Yes |
| %N | Priority of execution ^{#24} A value of 1 to 5 | Yes | -- |
| %H | Agent host name ^{#31} | Yes ^{#2} | -- |
| %I | Job number | Yes ^{#2, #17} | -- |
| %Y | The number of executions of jobnets or jobs that ended normally after the registration for execution ^{#13} | Yes | -- |
| %B | Scheduled execution start date and time obtained from a computed processing cycle ^{#7} | Yes ^{#4, #18, #22} | -- |
| %b | Scheduled execution start date and time obtained from a computed processing cycle ^{#7} | Yes ^{#4, #19} | -- |
| %a | Estimated time required for execution ^{#7} | Yes ^{#5, #16, #22} | -- |
| %O | Scheduled execution end date and time obtained from a computed processing cycle ^{#7} | Yes ^{#4, #14, #20, #22} | -- |
| %o | Scheduled execution end date and time obtained from a computed processing cycle ^{#7} | Yes ^{#4, #14, #21, #22} | -- |
| %v | Start time of the period that schedule and result information is output ^{#7, #28} | Yes ^{#6} | Yes ^{#6} |
| %w | End time of the period that schedule and result information is output ^{#7} | Yes ^{#6} | Yes ^{#6} |
| %F | Hold attribute of the next execution schedule ^{#26} yes no Before Abnormal End Before Warning End | Yes | -- |
| %i | Type of registration for execution immediate definit planned simulation | Yes ^{#9} | -- |
| %l | Execution registration number ^{#7} | Yes ^{#29} | -- |
| %r | Standard error output file name If the standard error output file does not exist, the default standard error output file name is output. The standard error output file will not exist when, for example, no jobs have been executed or no errors have occurred. If an external database is used, a standard error output file is created in the directory specified for the STDFILEOUTDIR environment setting parameter, and the file name is output to the standard output. | Yes ^{#8, #23} | -- |

| Format indicator | Output information | -f | -t |
|------------------|---|----------------|----|
| %r | Output example: /var/opt/jplajs2/jobinf/7.14a.0.8.err | Yes #8, #23 | -- |
| %d | Delay status none start-delay nest-start-delay end-delay nest-end-delay | Yes#25 | -- |
| %# | execution-ID | Yes#8 | -- |
| %m | Time at which start conditions are effective unlimited#7 | Yes#11 | -- |
| %q | Number of times by which start conditions are effective A decimal value unlimited | Yes#11 | -- |

Legend:

Yes: Format indicators specifiable in the -f or -t option

--: Format indicators not specifiable in the -f or -t option

#1

Valid only for a unit type of net. In the other cases, an asterisk (*) is output.

#2

Valid only for a unit type of job. In the other cases, an asterisk (*) is output.

#3

Information about a jobnet having a generation number of 0. If a jobnet is registered for release, the next schedule (information of generation number 0) that has the same definition as the output target will be output. For this reason, if a switch of the definition occurs between the output-target generation and the next schedule, output will be as if there is no next schedule.

#4

****/**/** **:** and ****/**/** **: **: ** are output if you also specify the -g option.

#5

For a jobnet and job not executed, a value of 1 is assumed.

#6

****/**/** **: **: ** is output if you do not specify the -b -e, -v, or -w option.

#7

For details about the output format, see [Table 3-23](#).

#8

For simulation, three asterisks (***) are output.

#9

Effective only when the unit type is net. Otherwise, three asterisks (***) are output.

#10

For a unit that is added while it is suspended, its output reads "plan unexecuted" if the existing upper-level unit is completed. Otherwise, the output reads "unplanned".

- #11
Effective only when the unit type is `net` or `condn`. Otherwise, three asterisks (***) are output.
- #12
For a job, the submitted time is output. For a queueless job, an event job or a custom event job, the time when the execution of the job was requested is output.
- #13
The total count after registration is output, regardless of the number of logs to keep or generations to be output.
- #14
The sum of the values of *Scheduled execution start date and time obtained from a computed processing cycle* and *Estimated time required for execution* is output as the time.
- #15
The start time at which the unit was re-executed is displayed.
When the unit is re-executed, the date/time re-execution started is set at the point re-execution of the upper-level jobnets started. If the root jobnet is being executed, however, the date/time of re-execution start is not set for the root jobnet.
When the root jobnet has been completed, the date/time re-execution started is set only for the root jobnet if the root jobnet is specified at the point re-execution started.
- #16
Output when `-b`, `-e`, `-v`, `-w`, `-B`, or an execution ID is specified.
In other cases, `00:00:00` is output.
- #17
For a queueless job, three asterisks (***) are output.
- #18
For a jobnet or job that has been completed, the date/time that is output here is the same as the actual date/time execution started for the jobnet or job (`%St`).
- #19
For a jobnet or job that has been completed, the date/time that is output here is the same as the actual date/time execution started for the jobnet or job (`%st`).
- #20
For a jobnet or job that has been completed, the date/time that is output here is the same as the actual date/time execution was completed for the jobnet or job (`%E`).
- #21
For a jobnet or job that has been completed, the date/time that is output here is the same as the actual date/time execution was completed for the jobnet or job (`%e`).
- #22
A result of execution simulation is output. For details about execution simulations, see *4.4.2(2) Execution simulation* in the manual *JP1/Automatic Job Management System 3 Overview*.
If the schedule is changed temporarily, execution simulation is performed based on the new time.
- #23
Effective only when the unit type is `job`, `netcn`, or a connection-destination jobnet.
Otherwise, three asterisks (***) are output.
- #24
Effective only when the unit type is `net`.

Otherwise, none is output (when the language type is English).

#25

Effective only when the unit type is any of the following:

net, pjob, job, qjob, evwjb, flwjb, mlwjb, mqwjb, mswjb, lfwjb, ntwjb, tmwjb, evsjb, mlsjb, mqsjb, mssjb, cmsjb, pwljb, pwrjb, cupjb, cuujb, cewj

Otherwise, three asterisks (***) are output.

#26

Effective only when the status of the jobnet or job is any of the following:

Wait for start time, Wait for prev. to end, Waiting to execute, Being held

Otherwise, three asterisks (***) are output.

#27

Effective only when the unit type is net or rnet. Otherwise, three asterisks (***) are output.

#28

For a flexible job, the following time is output.

When a relay agent is used:

Start time or end time of execution of the relay agent

When no relay agent is used:

Start time or end time of execution of the manager host

#29

For simulation, a non-scheduled generation, or a generation in Shutdown status, three asterisks (***) are output.

#30

For details about the status of a jobnet or job, see *6.1 Status levels of jobnets, jobs, and jobnet connectors* in the manual *JP1/Automatic Job Management System 3 Overview*.

#31

If it ends before the job starts on the execution host, for example, because the agent stopped or the job status changed, three asterisks (***) might be output.

Table 3–21: Two-byte format indicators for outputting definition information about jobnets and jobs

| Two-byte format indicator | Output information |
|---------------------------|--|
| %SP | The state of being suspended (or not) exist none |
| %OP | Execution date for a jobnet ^{#1} |
| %St | Actual execution start date and time of a jobnet or job ^{#1} |
| %st | Actual execution start date and time of a jobnet or job ^{#1} |
| %Pt | Date and time at which jobnet execution is to start ^{#2, #10} |
| %Jm | Full-path jobnet or job name (a root jobnet name is omitted for a unit in a planning group) |
| %Am | Character string specified with AJSPATH= (a root jobnet name is omitted for a unit in a planning group). Character string specified with %Jm except the part that follows the right-most slash (/). |

| Two-byte format indicator | Output information |
|---------------------------|--|
| %Ed | Whether or not to suppress the execution if the scheduled time for execution has passed during startup of the scheduler service. ^{#3} yes: Suppress the execution no: Do not suppress the execution |
| %cm | Comment ^{#4} (character string of up to 80 bytes) |
| %ab | Estimated time between the start of the abnormally ended job and the end of the root jobnet ^{#1, #5} |
| %an | Estimated time between the start of the unit next to the abnormally ended job and the end of the root jobnet ^{#1, #5} |
| %FG | Number of future generations ^{#6} (from 1 to 99) |
| %ds | Date/time for monitoring the start delay ^{#1} |
| %de | Date/time for monitoring the termination delay ^{#1, #7} |
| %Ft | Hold attributes hold: Holds not-hold: Does not hold abend-hold: Holds if the previous state was abend warning-hold: Holds if the previous state was warning hold-set: Sets the hold attribute temporarily, or sets hold when jobs or jobnets are registered for execution hold-release: Releases the hold attribute temporarily |
| %MV | Macro variable name and passing information specified at the time jobnets are registered for execution or the macro variable name and inherit result information taken over when jobs are executed ^{#1, #4, #8, #9, #21} |
| %CN | Unit full name of the connection-destination ^{#11, #14} If a jobnet connector is specified, the unit full name of the connection-destination jobnet is output. If a connection-destination jobnet is specified, the unit full name of the jobnet connector is output. |
| %CI | Execution ID of the connection-destination ^{#11, #12} If a jobnet connector is specified, the execution ID of the connection-destination jobnet is output. If a connection-destination jobnet is specified, the execution ID of the jobnet connector is output. |
| %CS | Method for controlling the execution order of the connection-destination jobnet ^{#13} |
| %CH | Host name of the connection-destination ^{#11, #15} If this format indicator is specified for a jobnet connector, the host name of the connection-destination jobnet is output. If this format indicator is specified for a connection-destination jobnet, the host name of the jobnet connector is output. |
| %CF | Name of the scheduler service for the connection-destination ^{#11, #15} If this format indicator is specified for a jobnet connector, the name of the scheduler service for the connection-destination jobnet is output. If this format indicator is specified for a connection-destination jobnet, the name of the scheduler service for the jobnet connector is output. |
| %RI | Release-ID ^{#16} |
| %SO | Standard output file name ^{#17, #18} The assumed standard output file name is output even if the standard output file does not exist. For example, the file does not exist if you specify a unit that does not use the standard output (an OR job, judgment job, event job, custom event job, jobnet connector, or connection-destination jobnet) or specify a job that has not been executed. If an external database is used, a standard output file is created in the directory specified for the STDFILEOUTDIR environment setting parameter, and the standard output file name is output to the standard output. |
| %PW | Whether any aspect of the wait condition is yet to be satisfied. exist: The wait condition is not satisfied |

| Two-byte format indicator | Output information |
|---------------------------|--|
| %PW | none: The wait condition is satisfied ***: No wait condition is defined |
| %RY | Number of retry executions ^{#19} |
| %RC | Retry status wait: An error occurred in an executable file of a job. Waiting is in progress for the time set as the retry interval to pass. exec: The job is being executed as a retry execution. end: They retry execution of the job finished. ***: No retry execution is performed. |
| %RS | Retry registration time ^{#1, #20} The date and time of submission for a retry execution (year, month, date, hour, and minute are output) |
| %Rs | Retry registration time ^{#1, #20} The date and time of submission for a retry execution (year, month, date, hour, minute, and second are output) |
| %RT | Retry start time ^{#1} The execution start date and time for a retry execution (year, month, date, hour, and minute are output) |
| %Rt | Retry start time ^{#1} The execution start date and time for a retry execution (year, month, date, hour, minute, and second are output) |

Note

The format indicators shown in [Table 3-20](#) allow specifying a set of two alphabetic characters as a two-byte format indicator. For example, %S can be specified as -i %SS. The -f and -t options will not accept two-byte format indicators. That is, all of the following are incorrect: -f %JJ, -t %JJ, and -f %SP.

#1

For details about the output format, see [Table 3-23](#).

#2

Effective only when the unit is a jobnet. Otherwise, an asterisk (*) is output.

#3

Effective only when the type of the unit is net, netcn, rmnet, or hlnet.
Otherwise, three asterisks (***) are output.

#4

Double quotation marks (") are output at the beginning and end of the character string.
If there is no value to be output, only "" is output.

#5

The required time is estimated based on the execution result after the root jobnet is registered for execution only when the -b, -e, -v, or -w option is specified. One minute is the estimate for a job that has never been executed in the generation containing a job that has ended abnormally. 0 seconds is the estimate for a job that has already ended normally. The information about a unit that has ended without being executed is not output by specifying the -b or -e option. To output the information about a unit that has ended without being executed, use the -v or -w option. For details about the estimated required time, see [Additional information 3](#) below.

#6

The *** string is output if the number of future generations is not specified at the time of registration for execution. This is the information about the root jobnet, which is 0 in the generation number sequence.

#7

If you use the time-required-for-execution to monitor the date/time for end delay, the monitoring date/time is not output. The * string is output instead.

#8

This is effective only when the unit type is root jobnet (excluding remote jobnets) or job. Otherwise, the *** string is output.

#9

The "" string is output for a pseudo schedule.

#10

The date and time that execution has been scheduled is output. If the schedule is temporarily changed, the new schedule is output.

#11

This is effective only when the unit type is a jobnet connector or jobnet (connection-destination jobnet).

Otherwise, the *** string is output. The *** string is also output when permission to view the jobnet connector or connection-destination jobnet is not granted.

If an invalid unit is specified as the unit to be connected by the jobnet connector or connection-destination jobnet, the execution ID, unit full name, host name, and scheduler service name are displayed. However, the status of the unit changes to *Ended abnormally* because a definition error occurs during execution.

To check whether the definition is correct, specify the jobnet connector in the `ajschkdef` command. For details on the `ajschkdef` command, see [ajschkdef in 3. Commands Used for Normal Operations](#) and [8. Definition Pre-Check in the JP1/Automatic Job Management System 3 System Design \(Work Tasks\) Guide](#).

#12

If a jobnet connector or connection-destination jobnet is defined on a different host or in a different scheduler service, the *** string is output for a generation scheduled to be executed.

For details about how to check the execution ID of a jobnet connector or connection-destination jobnet defined on a different host or in a different scheduler, see [Additional information 4](#) below.

#13

This is effective only for a connection-destination jobnet. Otherwise, three asterisks (***) are output.

#14

If **Connection range** is **Other service**, the information defined for the unit is output.

#15

If **Connection range** is **Same service**, the *** string is output.

#16

For a release target jobnet (a root jobnet for which release entry is made) or its subordinate unit, the release ID is output. Otherwise, three asterisks (***) are output.

#17

This is effective only when the unit type is any of the following:

net, pjob, job, qjob, evwjb, flwjb, mlwjb, mqwjb, mswjb, lfwjb, ntwjb, tmwjb, evsjob, mlsjob, mqsjob, mssjob, cmsjob, pwljob, pwrjob, cupjob, cuujob, orjob, jdjob, netcn, cewj

Otherwise, three asterisks (***) are output.

#18

For simulation, three asterisks (***) are output.

#19

0 is output if retry execution is not performed. For units that are not subject to automatic retry, *** is output.

#20

For a job, the time when the job was submitted is output. For a queueless job, the time when job execution was requested is output.

#21

For details about the result of inheriting information via macro variables, see 2.2.6(2)(b) *Viewing the result of inheriting information via macro variables* in the *JP1/Automatic Job Management System 3 System Design (Work Tasks) Guide*.

Table 3–22: Other format indicators

| Format indicator | Output information |
|------------------|---------------------------|
| %% | % |
| %n | Line feed character |
| %t | Tab character |
| %x | Current date [#] |
| %X | Current time [#] |

#

Time at which you started executing the `ajssh` command. For details about the output format, see the following table:

Table 3–23: Output format of format indicators

| Format indicator | Output format | |
|------------------|--|---|
| | Japanese | English |
| %D | YYYY/MM/DD hh:mm | MMM DD YYYY hh:mm |
| %P | For MM, DD, hh and mm, a zero (0) is prefixed. | For DD, if the value to be output is one digit, a space is prefixed. For hh and mm, a zero (0) is prefixed. |
| %S | Example: | Example: |
| %E | 2009/07/01 12:30 | Jul 1 2010 12:30 |
| %K | Note, however, that if there is no information to be output for the unit, ****/**/** **: ** is output. | Note, however, that if there is no information to be output for the unit, *** ** **** **: ** is output. |
| %V | | |
| %Q | | |
| %B | | |
| %O | | |
| %m | | |
| %St | | |
| %Pt | | |
| %ds | | |
| %de | | |
| %RS | | |
| %RT | | |
| %s | YYYY/MM/DD hh:mm:ss | MMM DD YYYY hh:mm:ss |
| %e | For MM, DD, hh, mm and ss, a zero (0) is prefixed. | For DD, if the value to be output is one digit, a space is prefixed. For hh and mm, a zero (0) is prefixed. |

| Format indicator | Output format | |
|---|---|---|
| | Japanese | English |
| %k %b %o %v %w %st %Rs %Rt | <p>Example:</p> <p>2009/07/01 12:30:00</p> <p>Note, however, that if there is no information to be output for the unit, ****/**/** **:**:** is output.</p> | <p>Example:</p> <p>Jul 1 2010 12:30:00</p> <p>Note, however, that if there is no information to be output for the unit, *** ** **** **:**:** is output.</p> |
| %x %OP | <p>YYYY/MM/DD</p> <p>For MM and DD, a zero (0) is prefixed.</p> <p>Example:</p> <p>2009/07/01</p> <p>Note, however, that if there is no information to be output for the unit, ****/**/** is output.</p> | <p>MMM DD YYYY</p> <p>For DD, if the value to be output is one digit, a space is prefixed.</p> <p>Example:</p> <p>Jul 1 2010</p> <p>Note, however, that if there is no information to be output for the unit, *** ** **** **:**:** is output.</p> |
| %X %a %ab %an | <p>hh:mm:ss</p> <p>Example:</p> <p>12:30:30</p> | |
| %l | <p>YYYYMMDDNNN</p> <p>Example:</p> <p>Job whose execution registration number is 20100701001</p> <p>20100701001</p> | |
| %MV | <p>"information-1:information-2" [, "information-1:information-2" [...]]</p> <p>information-1: macro variable name</p> <p>information-2: passing information, or inherit result information</p> <p>(Example 1) For the root jobnet</p> <p>"AJS2ENV:/data/job_report", "AJS2COM:c:\temp\test.exe"</p> <p>(Example 2) For a job</p> <p>"AJS2ENV:/data/job_report", "AJS2COM:c:\temp\test.exe"</p> | |

Additional information 2

The following table shows differences between information output when a target unit is automatically selected from the units in a planning group and that output when a target unit is not automatically selected.

Table 3–24: Differences in output information depending on whether a target unit is automatically selected from the units in a planning group

| Format indicator | When a target unit is automatically selected | When a target unit is not automatically selected |
|------------------|--|---|
| %p %P %M | Information about the unit to be executed next in the planning group | Schedule for the next execution of the specified unit |
| %G | Generation number obtained by integrating execution information for the root jobnets in the planning group | Generation number for the specified unit only |

| Format indicator | When a target unit is automatically selected | When a target unit is not automatically selected |
|----------------------|---|---|
| %l | Execution registration number obtained by integrating execution information for the root jobnets in the planning group | Execution registration number for the specified unit only |
| %Y %a | This information is maintained for each unit. Information for each unit is output even if you specify the function for automatically selecting a target unit. | |
| %B %b %O %o | Information obtained from processing cycle calculation is calculated based on information maintained for each unit. Information for each unit is output even if you specify the function for automatically selecting a target unit. | |

The following example planning group definition shows differences in information output with %P, %G, and %l depending on the specification with the -X option.

Example planning group definition

Planning group (/group1) has three units, /group1/jobnet001, /group1/jobnet002, and /group1/jobnet003.

The scheduled start times for the units are as follows:

The scheduled start time for /group1/jobnet001 is 08:00 (absolute time).

The scheduled start time for /group1/jobnet002 is 09:00 (absolute time).

The scheduled start time for /group1/jobnet003 is 10:00 (absolute time).

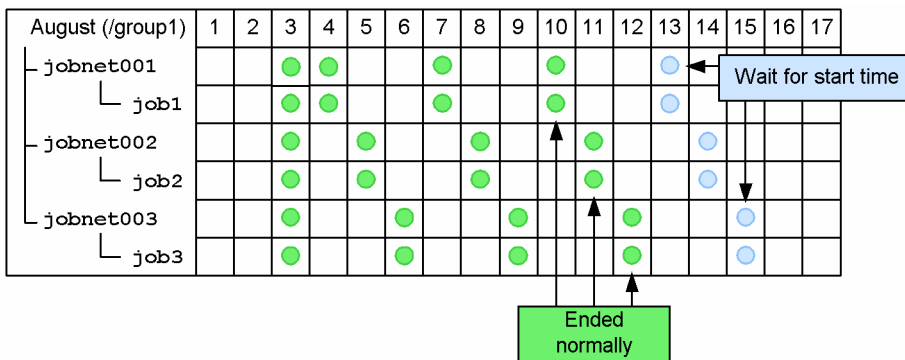

Example 1:

Information output with %P when the -X option is set to yes.

```
ajsshow -f "Next schedule=%P %C %J" -g 1 -X yes /group1
```

Output result

```
Next schedule=Aug 13 20XX 08:00 normal /group1/jobnet003
```

Explanation:

In this case, the command outputs the next scheduled execution time for the unit to be executed next (/group1/jobnet001) under the root jobnets in the planning group.

Example 2:

Information output with %P when the -X option is set to no.

```
ajsshow -f "Next schedule=%P %C %J" -g 1 -X no /group1/jobnet003
```

Output result

```
Next schedule=Aug 15 20XX 10:00 normal /group1/jobnet003
```

Explanation:

In this case, the command outputs the next scheduled execution time for the specified unit (/group1/jobnet003).

Example 3:

Information output with %G when the -X option is set to yes.

```
ajsshow -f "Generation=%G Start time=%S %C %J" -g 3 -X yes /group1
```

Output result

```
Generation=1 Start time=Aug 12 20XX 10:00 normal /group1/jobnet003
Generation=2 Start time=Aug 11 20XX 09:00 normal /group1/jobnet002
Generation=3 Start time=Aug 10 20XX 08:00 normal /group1/jobnet001
```

Explanation:

In this case, the command outputs the generation number obtained by integrating execution information for the root jobnets in the planning group.

Example 4:

Information output with %G when the -X option is set to no.

```
ajsshow -f "Generation=%G Start time=%S %C %J" -g 3 -X no /group1/jobnet
001
```

Output result

```
Generation=1 Start time=Aug 10 20XX 08:00 normal /group1/jobnet001
Generation=2 Start time=Aug 7 20XX 08:00 normal /group1/jobnet001
Generation=3 Start time=Aug 4 20XX 08:00 normal /group1/jobnet001
```

Explanation:

In this case, the command outputs the generation number based on execution information for the specified unit.

Example 5:

Information output with %l when the -X option is set to yes.

```
ajsshow -f "Registration number=%l Start time=%S %C %J" -b 20XX/8/3 -X ye
s /group1
```

Output result

```
Registration number=20XX0803001 Start time=Aug 3 20XX 08:00 normal /gr
oup1/jobnet001
Registration number=20XX0803002 Start time=Aug 3 20XX 09:00 normal /gr
oup1/jobnet002
Registration number=20XX0803003 Start time=Aug 3 20XX 10:00 normal /gr
oup1/jobnet003
```

Explanation:

In this case, the command outputs the execution registration number obtained by integrating execution information for the root jobnets in the planning group.

Example 6:

Information output with %l when the -X option is set to no.

```
ajsshow -f "Registration number=%l Start time=%S %C %J" -b 20XX/8/3 -X n
o /group1/jobnet003
```

Output result

```
Registration number=20XX0803001 Start time=20XX/08/03 10:00 Normal end
/group1/jobnet003
```

Explanation:

In this case, the command outputs the execution registration number based on execution information for the specified jobnet.

Additional information 3

The following example shows how to calculate the estimated required time for a job that has ended abnormally.

Example 1:

The following describes how to calculate the estimated required time to determine whether to immediately re-execute a job that has ended abnormally, using the example jobnet configuration as shown below.

| | 00:00 | 01:00 | 02:00 | 03:00 | 04:00 | 05:00 | 06:00 | 07:00 | 08:00 | 09:00 | ... |
|-----------------|-------|---------|---------|-------|---------|-------|---------|---------|-------|-------|-----|
| jobnet1 | | [Red] | | | | | | | | | |
| ├ nestjobnet001 | | [Red] | | | | | | | | | |
| │ └ job1 | | [Green] | | | | | | | | | |
| │ └ job2 | | | [Green] | | | | | | | | |
| │ └ job3 | | | | [Red] | | | | | | | |
| └ nestjobnet002 | | | | | [Red] | | | | | | |
| ├ job1 | | | | | [Green] | | | | | | |
| ├ job2 | | | | | | [Red] | | | | | |
| ├ job3 | | | | | | | [White] | | | | |
| └ job4 | | | | | | | | [White] | | | |

- Legend:
- [Red] : Ended abnormally
 - [Green] : Ended normally
 - [White] : Not executed + Ended

The jobs /jobnet1/nestjobnet001/job3 and /jobnet1/nestjobnet002/job2 have ended abnormally.

The following shows the output information and output results for %ab when the -v and -w options are specified.

Output information

```
ajsshow -i "Estimated required time=%ab UnitName=%JJ" -v 20XX/2/12 -w 2
0XX/2/12 -RN /jobnet1
```

Output result

```
Estimated required time=07:00:00 UnitName=/jobnet1
Estimated required time=07:00:00 UnitName=/jobnet1/nestjobnet001
Estimated required time=03:00:00 UnitName=/jobnet1/nestjobnet002
```

Explanation:

The output results indicate that the execution of `jobnet001` will require seven hours so that you might decide to re-execute only this unit (`jobnet1/nestjobnet001`) at night or immediately re-execute only the `jobnet1/nestjobnet002` unit, which will require three hours.

Example 2:

Suppose the jobnet that follows the abnormally ended job has a scheduled start time specified. The result of calculating the estimated required time may vary with whether the time when the job ends due to the start of re-execution precedes or follows the scheduled start time for the next jobnet.

- If the time when the job ends due to the start of re-execution precedes the scheduled start time for the next jobnet

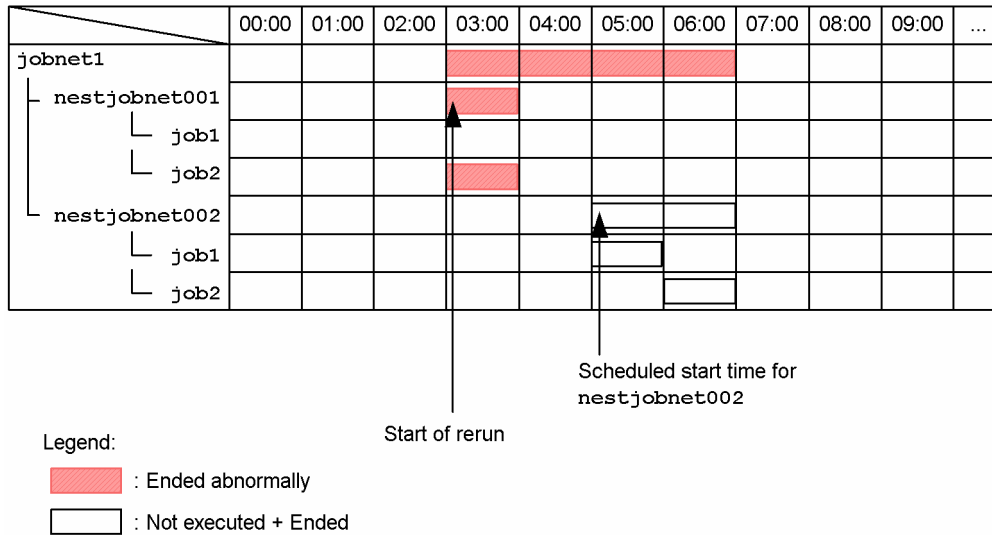

The job `/jobnet1/nestjobnet001/job2` has ended abnormally. The scheduled start time for the next jobnet (`/jobnet1/nestjobnet002`) is 05:00.

If re-execution starts at 03:00, the job `/jobnet1/nestjobnet001/job2` is executed between 03:00 and 04:00 and `nestjobnet001` ends at 04:00. The jobnet `nestjobnet002` waits until 05:00 (scheduled start time) and then starts at 05:00 and ends at 07:00. The following shows the output information and output results:

Output information

```
ajsshow -i "Estimated required time=%ab UnitName=%JJ" -v 20XX/8/21 -w 2
0XX/8/21 -d 20XX/8/21 -h 3:00 -RN /jobnet1
```

Output result

```
Estimated required time=04:00:00 UnitName=/jobnet1
Estimated required time=01:00:00 UnitName=/jobnet1/nestjobnet001
Estimated required time=02:00:00 UnitName=/jobnet1/nestjobnet002
```

Explanation:

The output results indicate that `jobnet1` will require four hours, 3:00 to 7:00.

- If the time when the job ends due to the start of re-execution follows the scheduled start time for the next jobnet

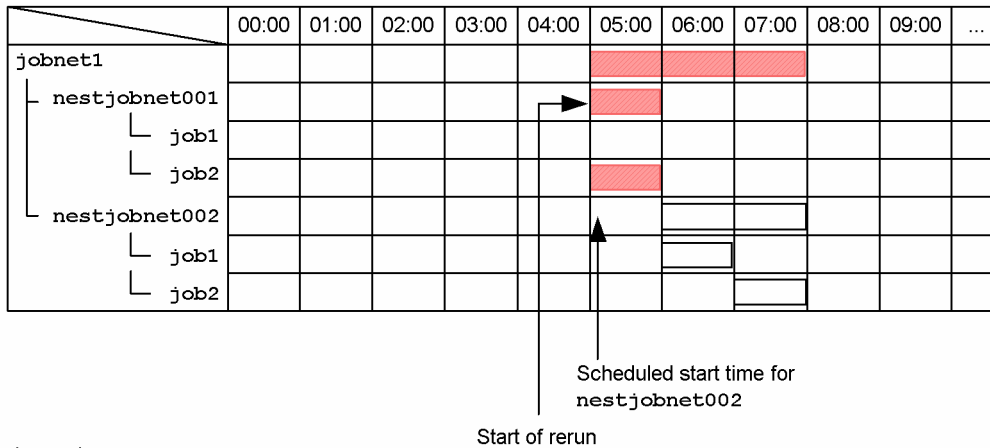

Legend:

- : Ended abnormally
- : Not executed + Ended

The job /jobnet1/nestjobnet001/job2 has ended abnormally. The scheduled start time for the next jobnet (/jobnet1/nestjobnet002) is 05:00.

If re-execution starts at 05:00, the job /jobnet1/nestjobnet001/job2 is executed between 05:00 and 06:00 and nestjobnet001 ends at 06:00. The jobnet nestjobnet002, for which the scheduled start time, 05:00 is already passed, is immediately executed and ends at 08:00. The following shows the output information and output results:

Output information

```
ajsshow -i "Estimated required time=%ab UnitName=%JJ" -v 20XX/8/21 -w 2
0XX/8/21 -d 20XX/8/21 -h 5:00 -RN /jobnet1
```

Output result

```
Estimated required time=03:00:00 UnitName=/jobnet1
Estimated required time=01:00:00 UnitName=/jobnet1/nestjobnet001
Estimated required time=02:00:00 UnitName=/jobnet1/nestjobnet002
```

Explanation:

The output results indicate that jobnet1 will require three hours, 5:00 to 8:00.

As shown above, you can specify the `-d` and `-h` options when calculating the estimated required time to determine how long re-execution will take depending on the time when re-execution is started.

Additional information 4

If a jobnet connector or a connection-destination jobnet connector is defined on a different host or in a different scheduler service, `***` is output even if `%CI` is specified in the `-i` option.

If you want to check the execution ID of a jobnet connector or connection-destination jobnet defined on a different host or in a different scheduler, remotely execute the `ajsshow` command as described in the following procedure.

To check the execution ID of a jobnet connector or connection-destination jobnet defined on a different host or in a different scheduler:

1. Remotely execute the `ajsshow` command to display the host name, scheduler service name, and unit full name of the connection-destination.

Execute the following command:

```
ajsshow -v 20XX/07/01 -i "%CH %CF %CN" unit-name
```

2. Display the execution ID of the connection-destination from the information displayed in step 1.

Execute the following command:

```
host-name-displayed-in-step-1:scheduler-service-name-displayed-in-step-1:ajsshow -v 20XX/07/01 -i "%CI" unit-name
```

Additional information 5

If you specify `a` for the `-g` option, execution result information for jobnets with start conditions specified is output in order from the generation with the latest scheduled start time to the one with the earliest.

If you register a jobnet for execution with start conditions specified, a generation for monitoring the start conditions is created when the start time is reached. At the same time, generations in the Wait for start cond. status are also created and are executed when the start conditions are satisfied.

The scheduled start time for the generation being monitored is also assumed for the generations in the Wait for start cond. status and the generations executed when start conditions are satisfied. If you are using jobnets with start conditions and jobnets without start conditions, note the order in which the execution result information is output.

The following shows an example when the number of logs to keep is 10. In this example, a jobnet (`net`) with start conditions specified is registered for execution, and later a jobnet without start conditions specified is registered for execution.

- When the number of logs to keep is 10

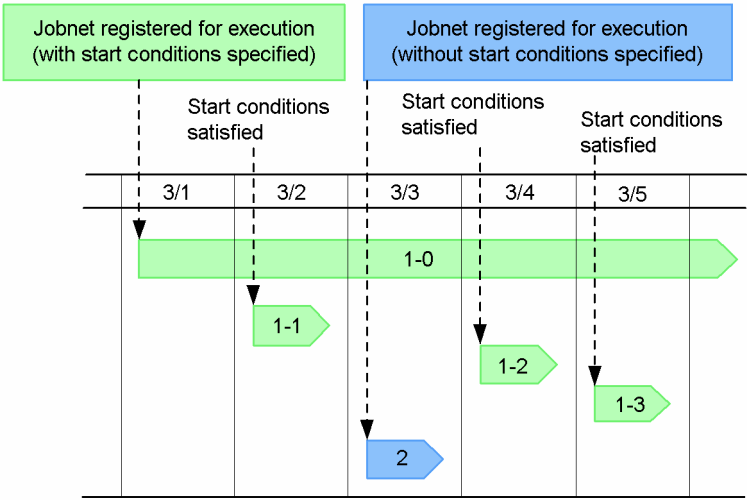

As shown, a jobnet (`net`) with start conditions specified is registered for execution on March 1 and a generation for monitoring the start conditions is created (1-0 in the figure). At the same time, generations in the Wait for start cond. status are created. These generations are executed on March 2, March 4, and March 5 when their start conditions are satisfied (1-1, 1-2, and 1-3 in the figure).

In addition, a jobnet (`net`) without start conditions specified is registered for execution on March 3(2 in the figure).

Output information

```
ajsshow -f "Generation=%G %J %# %C" -g a -T /net
```

Output result

```
Generation=1 /net @A103 Normal end
Generation=2 /net @A105 Wait for start cond.#
Generation=3 /net @A104 Normal end#
Generation=4 /net @A102 Normal end#
Generation=5 /net @A101 Normal end#
Generation=6 /net @A100 Now monitoring#
```

Execution result information for a generation with start conditions specified

Explanation:

When you execute the `ajsshow` command to output execution result information, the result of executing the jobnet that was registered for execution on March 3 is output as generation 1, since it is the latest execution result of the jobnet (`net`). For generations 2 to 6, the results of executing the jobnet with start conditions registered for execution on March 1 are output in order by generation according to the generation whose start conditions were satisfied last.

Example 1

The following command outputs the results of executing jobnet `net1`, and jobnets and jobs in it to the standard output file.

```
ajsshow -l net1
```

Example 2

The following command outputs two generations of results of executing a jobnet in the job group `group1`. The information to be displayed is the full-path jobnet name, the execution start time, and the execution end time.

```
ajsshow -t"Generation: %G" -g2 -f"%J %S %E" -RE /group1
```

Output example

```
Generation: 1
/group1/net1 Jun  8 20XX  10:00 Jun  8 20XX  12:00
Generation: 2
/group1/net1 Jun  1 20XX  10:00 Jun  1 20XX  11:30
Generation: 1
/group1/net2 Jun  8 20XX  11:00 Jun  8 20XX  11:30
Generation: 2
/group1/net2 Jun  1 20XX  11:00 Jun  1 20XX  12:00
```

Example 3

The following command outputs scheduled execution information (jobnet name, generation number and execution start time) on jobnet `net` for July 2010 (July 1, 2010 to July 31, 2010), displaying the target output period on the title row.

```
ajsshow -t "Period %v-%w" -f" %j %G %B"-b 2010/7/1 -e 2010/7/31 /net
```

Output example

```
Period Jul  1 2010  00:00:00-Jul 31 2010 23:59:59
net -5 Jul  7 2010   10:00
Period Jul  1 2010  00:00:00-Jul 31 2010 23:59:59
```

```

net -6 Jul 14 2010 10:00
Period Jul 1 2010 00:00:00-Jul 31 2010 23:59:59
net -7 Jul 21 2010 10:00
Period Jul 1 2010 00:00:00-Jul 31 2010 23:59:59
net -8 Jul 31 2010 10:00

```

Example 4

The following command outputs the name of the standard error output file for job `job1` in jobnet `net`, whose execution registration number is `20100701001`. Assume that the job error information directory (`/var/opt/jplajs2/jobinf`) is set for the `JOBINFDIR` environment setting parameter.

```
ajsshow -B 20100701001 -r /net/job1
```

Output example

```
/var/opt/jplajs2/jobinf/e/67/0.e.err
```

Example 5

For the following jobnet (`net`) and jobs (`job1`, `job2`, and `job3`) under the jobnet, this example specifies the period using the `-b`, `-e`, `-v`, and `-w` options to output the execution start and end dates and times.

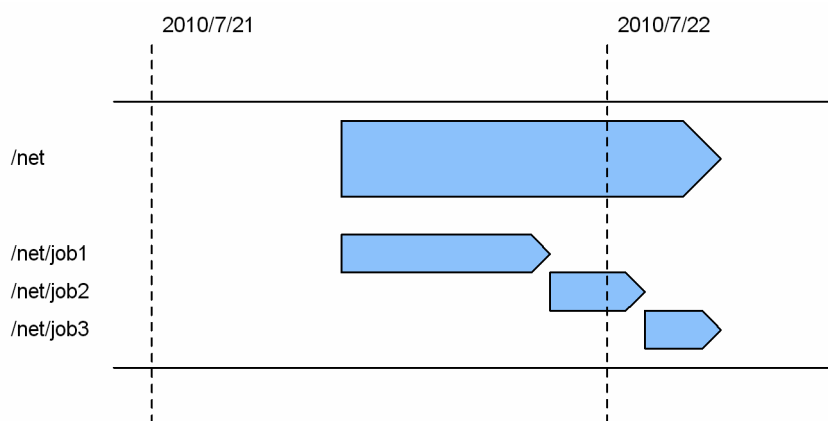

 : Execution time

Specifying 2010/07/21 in the `-b` and `-e` options

```
ajsshow -b 2010/07/21 -e 2010/07/21 -f "%S %E %J" -R /net
```

Output example

```

Jul 21 2010 10:00 Jul 22 2010 06:00 /net
Jul 21 2010 16:00 Jul 21 2010 21:00 /net/job1
Jul 21 2010 21:00 Jul 22 2010 02:00 /net/job2

```

Explanation:

The calendar date is the target of output.

The output covers the information about `net` as well as `job1` and `job2` under `net` where execution is started on 2010/07/21.

Specifying 2010/07/21 in the -v and -w options

```
ajsshow -v 2010/07/21 -w 2010/07/21 -f "%S %E %J" -R /net
```

Output example

```
Jul 21 2010 10:00 Jul 22 2010 06:00 /net
Jul 21 2010 16:00 Jul 21 2010 21:00 /net/job1
Jul 21 2010 21:00 Jul 22 2010 02:00 /net/job2
Jul 22 2010 02:00 Jul 22 2010 06:00 /net/job3
```

Explanation:

The execution date for the jobnet is the target of output.

The output covers the information about `net` as well as the three jobs under `net` where execution is started on 2010/07/21.

Specifying 2010/07/22 in the -b and -e options

```
ajsshow -b 2010/07/22 -e 2010/07/22 -f "%S %E %J" -R /net
```

Output example

```
Jul 21 2010 10:00 Jul 22 2010 06:00 /net
Jul 21 2010 21:00 Jul 22 2010 02:00 /net/job2
Jul 22 2010 02:00 Jul 22 2010 06:00 /net/job3
```

Explanation:

The calendar date is the target of output.

The output covers the information about `job2` where execution is ended on 2010/07/22, and `job3` where execution is started on 2010/07/22.

Specifying 2010/07/22 in the -v and -w options

```
ajsshow -v Jul 22 2010 -w Jul 22 2010 -f "%S %E %J" -R /net
```

Explanation:

The execution date for the jobnet is the target of output.

The output covers no information even if you specify 2010/07/22 in the `-v` and `-w` options because the execution date for `net` is 2010/07/21.

Example 6

This example explains how you can output information about a jobnet connector or connection-destination jobnet by using the `-i` option.

- jobnet connector
 - host name: HOSTA
 - scheduler service name: AJSROOT1
 - unit name: /JC/jobnet-connector
 - execution ID: @A544
- connection-destination jobnet
 - host name: HOSTB
 - scheduler service name: AJSROOT2
 - unit name: /JC-NET

execution ID: @A546

When a jobnet connector is specified for the `-i` option:

```
ajsshow -i "%JJ %TT %CH %CF %CN %CI %CS" /JC/jobnet-connector
```

Output example

```
/JC/jobnet-connector netcn HOSTB AJSROOT2 /JC-NET @A546 ***
```

When a connection-destination jobnet is specified for the `-i` option:

```
ajsshow -i "%JJ %TT %CH %CF %CN %CI %CS" /JC-NET
```

Output example

```
/JC-NET net HOSTA AJSROOT1 /JC/jobnet-connector @A544 nosync
```

Example 7

The following command outputs the name of the standard output file used by job `job1` in jobnet `net` executed in the period from 2010/08/06 to 2010/08/07. Assume that the job information storage directory (`C:\Program Files\HITACHI\JP1AJS2\jobinf`) is set for the `JOBINFDIR` environment setting parameter.

```
ajsshow -b 2010/08/06 -e 2010/08/07 -i "%so" /net/job1
```

Output example

```
C:\Program Files\HITACHI\JP1AJS2\jobinf\d\6e\0.e.std
```

Example 8

The following figure shows an example of using the `-xi` option for registering jobnet execution. 7/1 is registered when a start condition is used, and 7/2 is registered when a start condition is not used.

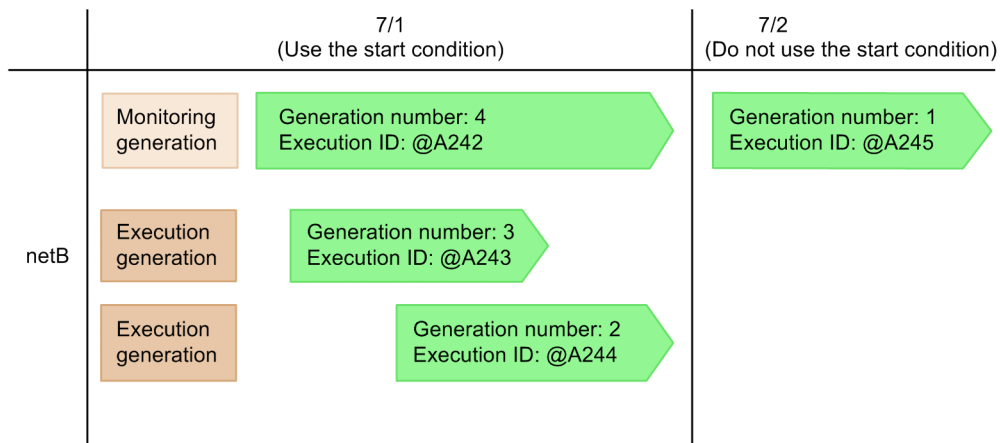
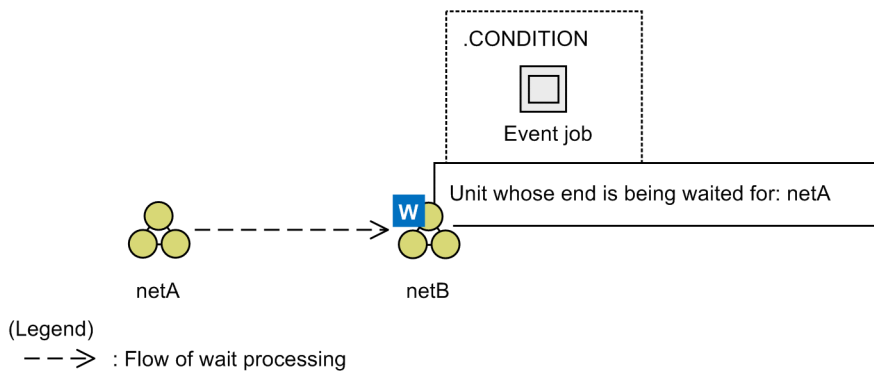

Information about the jobnet (netB) in the figure is output.

Example 1: When all generations are output and the `-xi b` option is specified

```
ajsshow -xw -xi b -g a /netB
```

Output example

```
AJSPATH = /
An unit with wait condition                                Unit whose end is being waited for
Name  Generation  Execution ID  Status          Wait method  No generations to wait for
Wait status      Status          Execution ID  Comment  Name
netB  1          @A245      monitor-normal OR          Execute
Incomplete      no entry      ***          ***          /netA
KAVS0780-E Specified Jobnet (/netB) has no information for display.
KAVS0780-E Specified Jobnet (/netB) has no information for display.

AJSPATH = /
An unit with wait condition                                Unit whose end is being waited for
Name  Generation  Execution ID  Status          Wait method  No generations to wait for
Wait status      Status          Execution ID  Comment  Name
netB  4          @A242      abnormal      OR          Execute
Incomplete      no entry      ***          ***          /netA
```

Explanation:

Information about the monitoring generations, execution generations, and generations that do not use a start condition are output. Generations 1 to 4 in the figure are subject to output. Note, however, that the `ajsshow` command ends abnormally because generations 2 and 3 are execution generations and there is no wait information.

Example 2: When all generations are output with the `-xi c` option specified

```
ajsshow -xw -xi c -g a /netB
```

Output example

```

AJSPATH = /
An unit with wait condition                                Unit whose end is being waited for
Name  Generation  Execution ID  Status          Wait method    No generations to wait for
When Unmonitored + Ended  Abnormal end for an execution generation  Wait status
Status          Execution ID  Comment  Name
net B  1      @A245    monitor-normal  OR      Execute
Execute                Execute                Incomplete
no entry    ***      ***      /netA

AJSPATH = /
An unit with wait condition                                Unit whose end is being waited for
Name  Generation  Execution ID  Status          Wait method    No generations to wait for
When Unmonitored + Ended  Abnormal end for an execution generation  Wait status
Status          Execution ID  Comment  Name
net B  4      @A242    abnormal      OR      Execute
Execute                Execute                Incomplete
no entry    ***      ***      /netA

```

Explanation:

Generations 1 and 4 are subject to output, because information about the monitoring generation and generations that do not use a start condition is to be output. Generations 2 and 3 are not output because they are execution generations.

Output example 1

- When you specify the -s option

```

AJSPATH = /ajspath/
Name      Type      Status      Plan      Registrant      Registered time
ajsnet1  net      time-wait  exist     ajsuser        Aug 1 20XX 17:25

```

- When you specify the -p option

```
AJSPATH = /ajspath/
```

| Name | Type | Status | Plan | Next execution time | Method |
|----------------|------------|-----------|-------|------------------------|--------|
| ajsnet1 | net | time-wait | exist | Aug 1 20XX 8:40 | plan |

- When you specify the -l option

```
AJSPATH = /ajspath/
```

| Name | Type | Status | Code | Start time | End time |
|----------------|------------|----------|------|------------------------|------------------------|
| ajsnet1 | net | abnormal | *** | Aug 1 20XX 8:40 | Aug 1 20XX 8:43 |

```
AJSPATH = /ajspath/ajsnet1/
```

| Name | Type | Status | Code | Start time | End time |
|-----------------|------------|----------|------|------------------------|------------------------|
| ajsnet21 | net | normal | *** | Aug 1 20XX 8:40 | Aug 1 20XX 8:43 |
| ajsnet22 | net | abnormal | *** | Aug 1 20XX 8:43 | Aug 1 20XX 8:50 |
| job3 | job | unknown | *** | *** ** ** ** ** | *** ** ** **^* |

```
AJSPATH = /ajspath/ajsnet1/ajsnet21/
```

| Name | Type | Status | Code | Start time | End time |
|---------------|------------|--------|------|------------------------|------------------------|
| job211 | job | normal | 0 | Aug 1 20XX 8:40 | Aug 1 20XX 8:41 |
| job212 | job | normal | 0 | Aug 1 20XX 8:41 | Aug 1 20XX 8:43 |

```
AJSPATH = /ajspath/ajsnet1/ajsnet22/
```

| Name | Type | Status | Code | Start time | End time |
|----------------|-------------|----------|------|------------------------|------------------------|
| job221 | job | normal | 0 | Aug 1 20XX 8:43 | Aug 1 20XX 8:45 |
| job222 | job | abnormal | 12 | Aug 1 20XX 8:45 | Aug 1 20XX 8:47 |
| rjob222 | rjob | normal | 0 | Aug 1 20XX 8:47 | Aug 1 20XX 8:50 |

Explanation of the output items

AJSPATH=

Indicates the contents of the full-path jobnet or job name except the jobnet or job name covered in *name*.

Name

Indicates a jobnet or job name.

Type

Indicates the type of a unit.

mgroup: Manager job group

group: Job group

mnet: Manager jobnet

condn: Start condition (. CONDITION)
net: Jobnet
rnet: Jobnet for recovery
rmnet: Remote jobnet
rrnet: Remote jobnet for recovery
job: Unix job
rjob: Unix job for recovery
pjob: PC job
rpjob: PC job for recovery
qjob: QUEUE job
rqjob: QUEUE job for recovery
jdjob: Judgment job
rjdjob: Judgment job for recovery
orjob: OR job
rorjob: OR job for recovery
cmsjb: OpenView status report job
rcmsjb: OpenView status report job for recovery
evwjb: JP1 event reception monitoring job
revwjb: JP1 event reception monitoring job for recovery
flwjb: File monitoring job
rflwjb: File monitoring job for recovery
mlwjb: Email reception monitoring job
rmlwjb: Email reception monitoring job for recovery
mqwjb: Message queue reception monitoring job
rmqwjb: Message queue reception monitoring job for recovery
mswjb: MSMQ reception monitoring job
rmswjb: MSMQ reception monitoring job for recovery
lfwjb: Log file monitoring job
rlfwjb: Log file monitoring job for recovery
ntwjb: Windows event-log monitoring job
rntwjb: Windows event-log monitoring job for recovery
tmwjb: Execution interval control job
rtmwjb: Execution interval control job for recovery
evsjb: JP1 event sending job
revsjb: JP1 event sending job for recovery
mlsjb: Email sending job
rmlsjb: Email sending job for recovery
mqsjb: Message queue sending job
rmqsjb: Message queue sending job for recovery
mssjb: MSMQ sending job
rmssjb: MSMQ sending job for recovery
pwljb: Local power control job

rpwljb: Local power control job for recovery
pwrjb: Remote power control job
rpwrjb: Remote power control job for recovery
cuujb: Custom Unix job
rcuujb: Custom Unix job for recovery
cupjb: Custom PC job
rcupjb: Custom PC job for recovery
netcn: Jobnet connector
n: Job group
p: Planning group
fxj: Flexible job
rfxj: Flexible job for recovery
htpjb: HTTP Connection job
rhtpjb: HTTP Connection job for recovery
cewjb: Custom event job
rcewjb: Custom event job for recovery

Status

Indicates the status of a jobnet or job.

Plan

Indicates whether the displayed jobnet or job is scheduled to be executed next.

exist: The jobnet or job is scheduled to be executed next.

none: The jobnet or job is not scheduled to be executed next.

Registrant

Indicates the name of the user who registered the jobnet for execution.

Registered time

Indicates the date and time when the jobnet was registered for execution.

Next execution time

Indicates the scheduled next execution time.

If the next execution time is not scheduled, *** ** ***** **: ** is displayed.

Method

Indicates the method of the next execution.

schedule: Follows the planned execution schedule for execution.

plan: Changes the plan temporarily for execution

shift: Shift for execution

Code

Indicates the return value or the cancellation signal code.

If there is no return value or signal code, *** appears.

Start time

Indicates the execution start date and time.

If execution is not started, *** ** ***** **: ** appears.

End time

Indicates the execution end date and time.

If execution is not ended, `*** ** ***** **:*` appears.

Output example 2

- When the `-xw` and `-xi b` options are specified

```
AJSPATH = /ajspath/

An unit with wait condition                                Unit whose end is being waited for
Name  Generation  Execution ID  Status    Wait method  No generations to wait for
Wait status      Status  Execution ID  Comment   Name
job1   1234    @A101     term-wait AND      Execute
Complete_manually normal @825903647 task A    /netA
```

- When the `-xw` and `-xi c` options are specified

```
AJSPATH = /

An unit with wait condition                                Unit whose end is being waited for
Name  Generation  Execution ID  Status    Wait method  No generations to wait for
When Unmonitored + Ended  Abnormal end for an execution generation  Wait status
Status      Execution ID  Comment   Name
job1   1234    @A101     term-wait AND      Execute
Execute                                Execute                                Complete_manually
monitor-normal @A120    WorkA    /netA
```

Explanation of the output items

AJSPATH=

The full path name of the jobnet or job without the unit name output as the *Name* item.

An unit with wait condition

Indicates that the following information relates to a unit with wait conditions.

Name

The jobnet name or job name of the unit with wait conditions.

Generation

The generation number of the unit with wait conditions. If you specified a future generation, this item outputs a negative value.

Execution ID

The execution ID of the unit with wait conditions.

Status

The status of the unit with wait conditions.

Indicates the status of the monitoring generation when a unit with wait conditions is a jobnet with start conditions.

Wait method

The wait method.

AND: The wait condition is satisfied when all units whose ends are being waited for finish executing.

OR: The wait condition is satisfied when any one of the units whose ends are being waited for finishes executing.

No generations to wait for

The behavior of the unit with wait conditions when there are no applicable generations of the units whose ends are being waited for.

Execute: When there are no applicable generations of the units whose ends are being waited for, the unit starts executing.

Do not execute: When there are no applicable generations of the units whose ends are being waited for, the unit with wait conditions continues waiting for the wait condition to be satisfied.

When Unmonitored + Ended

Indicates the behavior of a unit with wait conditions when the unit with wait conditions is a jobnet with start conditions, and the monitoring generation is in the *Unmonitored + Ended* status.

Execute: When the monitoring generation is in the *Unmonitored + Ended* status, the unit with wait conditions starts execution.

Do not execute: When the monitoring generation is in the *Unmonitored + Ended* status, the unit with wait conditions does not start execution.

Abnormal end for an execution generation

Indicates the behavior of a unit with wait conditions when a unit with wait conditions is a jobnet with start conditions, and the execution generation ended abnormally.

Execute: If the execution generation ends abnormally, the unit with wait conditions starts execution.

Do not execute: When the execution generation ends abnormally, the unit with wait conditions does not start execution.

Wait status

The wait status with respect to the unit whose end is being waited for

Incomplete: The end of the waiting-target unit is still being waited for.

Complete: The wait process has completed.

Incomplete_manually: The end of the waiting-target unit is still being waited for, as a result of manual reinstatement of the wait condition.

Complete_manually: The end of the waiting-target unit is no longer being waited for, as a result of manual deactivation of the wait condition.

Incomplete_rerun: The waiting-target unit has ended. However, the wait status is regarded as incomplete because the status was changed from abnormal end when the subsequent unit was re-executed.

Unit whose end is being waited for

Indicates that the following information relates to a unit whose end is being waited for.

Status

The status of the unit whose end is being waited for. If the target of the wait condition is a planning group, this item displays the status of the unit in the planning group whose end is actually being waited for.

Asterisks (***) appear for this item when:

- The definition of the unit whose end is being waited for is invalid
- There are no applicable generations of the unit whose end is being waited for
- The unit whose end is being waited for is not registered

Execution ID

The execution ID of the unit whose end is being waited for. If the target of the wait condition is a planning group, this item displays the execution ID of the unit in the planning group whose end is actually being waited for.

Asterisks (***) appear for this item when:

- The definition of the unit whose end is being waited for is invalid
- There are no applicable generations of the unit whose end is being waited for
- The unit whose end is being waited for is not registered

Comment

The comment defined for the unit whose end is being waited for. If the target of the wait condition is a planning group, this item displays the comment for the unit in the planning group whose end is actually being waited for.

Asterisks (***) appear for this item when:

- The definition of the unit whose end is being waited for is invalid
- There are no applicable generations of the unit whose end is being waited for
- The unit whose end is being waited for is not registered
- You do not have reference permission for the unit whose end is being waited for

Name

The full path name of the unit whose end is being waited for.

ajsstart

Format

```
ajsstart
  [-c|-o|-t]
  [-F service-name]
  [-s {none|EXEC}]
  [-w]
  [-R]
  [-D]
```

Description

Starts the scheduler service for JP1/AJS3 and executes any jobnet registered for execution.

Execution privileges

In Windows: Administrators privilege

In UNIX: Superuser privilege

Arguments

-c

Forcibly cancels the execution registration of all jobnets and starts ("cold-starts") the scheduler service.

The following situations require a cold start:

- When the database table structure in the JP1/AJS3 scheduler has been modified
- When you cannot start a scheduler service

When you cold-start a scheduler service, you must re-register the jobnet for execution after the scheduler service is started.

Cold-starting a scheduler service deletes all execution results for all the previous generations for all jobnets. We recommend that you store any necessary log information before attempting to perform cold start.

You cannot specify this option together with the -R or -D option.

If none of the -c, -R, and -D options are specified, the scheduler service is started in warm-start mode.

-o

Does not execute a jobnet which is scheduled to execute on the day when you start the scheduler service, if its scheduled time for starting execution is prior to the time when you start the scheduler service.

If you omit this option, the system automatically executes a jobnet when you start the scheduler service, even if its scheduled time for starting execution is prior to the time when you start the scheduler service.

If you specify this option together with the -R option, this option is disabled.

-t

Does not execute a jobnet scheduled for planned execution or fixed execution for the day.

If you specify this option together with the `-R` option, this option is disabled.

-F *service-name*

Specify the name of the target scheduler service.

You can specify a character string of 1 to 30 bytes.

If you omit this option, the system assumes the default scheduler service name.

-s { *none* | EXEC }

Specify whether you want to suppress the execution of a jobnet or job, or cancel suppression.

- `none`
Cancels the suppression of execution for a jobnet or job.
- `EXEC`
Suppresses the execution of a jobnet or job. Once the system has completed the execution of the jobnet or job currently being executed, it will not start any subsequent jobnet or job.

-w

Terminates the command once the scheduler service is started.

-R

Continues the execution of any jobnet or job which was running when the scheduler service was previously stopped. (A hot start is performed.)

Jobnet

Continues execution with the status when the scheduler service was stopped.

This option also executes any jobnet that has passed the scheduled start time after the scheduler service is started.

Job

Obtains the job status when the scheduler service was stopped, and continues execution with that status.

You cannot specify this option together with the `-c` or `-D` option.

If none of the `-c`, `-R`, and `-D` options are specified, the scheduler service is started in warm-start mode.

-D

Starts the scheduler service in disaster recovery mode. For details on disaster recovery mode, see *6.2.1 Temporarily changing the start mode of JP1/AJS3* in the *JP1/Automatic Job Management System 3 Administration Guide*.

You cannot specify this option with the `-c`, `-R`, or `-s` option.

If none of the `-c`, `-R`, and `-D` options are specified, the scheduler service is started in warm-start mode.

Notes

- Before executing this command, you must start JP1/AJS3.
For UNIX, use the `jajs_spm` command to start the JP1/AJS3 process.
For Windows, use the Service dialog box or the Service window to start the JP1/AJS3 service.
- If you move the system date or time backward, cold-start the entire JP1/AJS3 system.

- If you use the `ajslocaldate` command to change the local date and time of a scheduler service, cold-start the scheduler service.
- This command terminates abnormally if a scheduler service is already started.
- If none of the `-c`, `-R`, and `-D` options are specified, the scheduler service is started in warm-start mode.
- When you have to cold start a scheduler service if a failure occurs, we recommend that you collect necessary log information beforehand. For how to collect log information, see *1.3 Data to be collected when a problem occurs* in the manual *JP1/Automatic Job Management System 3 Troubleshooting* and *1.4 Collecting data for troubleshooting* in the manual *JP1/Automatic Job Management System 3 Troubleshooting*.
- The scheduler service will not start if the environment settings[#] are invalid.

#

The environment settings for the scheduler service.

- If you want to cold start the scheduler service which uses the ISAM database, ensure that no process is accessing the database (you have not used any JP1/AJS3 command after logging off JP1/AJS3 - View) before attempting the cold start. If any process is accessing the database, the system fails to erase registered information so that it cannot start the service, resulting in abnormal end with the KAVS0218-E The database is still being accessed, so the cold start of the scheduler service (*scheduler-service-name*) ended abnormally. error message output to the Windows event log or Syslog.
- If you perform a hot start with the `-R` option specified or a warm start for the scheduler service and cannot acquire the status of a job, the job might have been placed in Unknown end status and then terminated. For details about the conditions when the job status cannot be acquired, see the *Job (Unix job, PC job, flexible job, HTTP connection job, action job, custom job)* column in *Table 6-3 Jobnet and job statuses when a hot-start is performed (-hot)* or *Table 6-4 Jobnet and job statuses when a warm-start is performed (-warm)* in *6.2.1(3) Jobnet and job statuses for each start mode* in the *JP1/Automatic Job Management System 3 Administration Guide*.
- When you use this command to start the scheduler service, the value of the `OVERSCHEDULE` environment setting parameter has no effect. Instead, execution follows `ajsstart` command operation. The following table shows the relationship between the `OVERSCHEDULE` environment setting parameter and the `ajsstart` command options.

Table 3–25: Relationship between the OVERSCHEDULE environment setting parameter and ajsstart command options

| OVERSCHEDULE setting | ajsstart command options |
|---|--|
| The <code>OVERSCHEDULE</code> environment setting parameter is set to <code>exec</code> . | The <code>-t</code> and <code>-o</code> options are not specified. |
| The <code>OVERSCHEDULE</code> environment setting parameter is set to <code>skip</code> . | The <code>-o</code> option is specified. |
| The <code>OVERSCHEDULE</code> environment setting parameter is set to <code>plan</code> . | The <code>-t</code> option is specified. |

- You cannot execute this command together with any of the following commands on the same logical host:

`ajsprofalter` command

`ajsembdbstart` command

`ajsembdbstop` command

`jajs_hstd` command

`jajs_hstd_stop` command

`jajs_spmc` command (if the `-n` value is not `jajs_schd`)

`jajs_spmc_status` command

`jajs_spmc_stop` command (if the `-n` value is not `jajs_schd`)

`jajs_start` command (UNIX only)

`jajs_start.cluster command (UNIX only)`

`jajs_stop command (UNIX only)`

`jajs_stop.cluster command (UNIX only)`

- You cannot execute this command together with any of the following commands if the same scheduler service is specified:

`ajsstart command`

`ajsstop command`

`jajs_spmd command (if the -n value is jajs_schd)`

`jajs_spmd_stop command (if the -n value is jajs_schd)`

Return values

| | |
|--|--------------|
| 0 | Normal end |
| Multiple of 4 within the range from 4 to 124 | Abnormal end |

Example 1

The following command cold-starts a scheduler service AJSROOT1:

```
ajsstart -F AJSROOT1 -c
```

Example 2

The following command warm-starts a scheduler service AJSROOT1:

```
ajsstart -F AJSROOT1
```

Example 3

The following command hot-starts a scheduler service AJSROOT1:

```
ajsstart -F AJSROOT1 -R
```

Example 4

The following command disaster-recovery-starts a scheduler service AJSROOT1:

```
ajsstart -F AJSROOT1 -D
```

ajsstatus

Format

```
ajsstatus
  [-F service-name]
  [-h host-name]
  [-v|-c]
```

Description

The current operating environment of a scheduler service, and connection information about JP1/AJS3 - View, JP1/AJS3 - Web Console or the external database connected to JP1/AJS3 - Manager is output to the standard output file. For details about the output format, see *Output example 1*, *Output example 2*, *Output example 3*, and *Output example 4* later in this section.

Execution privileges

None

However, either of the following settings is required when you use the `-h` option to execute the `ajsstatus` command for other hosts:

- The name of the OS user who executes the command is mapped to the JP1 user of the execution target host.
- The JP1 user of the execution target host is specified in the environment variable `JP1_USERNAME`.

Arguments

-F *service-name*

Specify the name of the target scheduler service.

You can specify a character string of 1 to 30 bytes.

If you omit this option, the system assumes the default scheduler service name.

-h *host-name*

If you want to output the current operating environment for a scheduler service on another host, specify the name of the host containing the target scheduler service.

You can specify a character string of 1 to 255 bytes.

If you omit this option, the system assumes the current host name (the name of the JP1/AJS3 - Manager host being used).

-v

Specify this option to output the connection information of JP1/AJS3 - View connected to JP1/AJS3 - Manager.

The connection information is information of JP1/AJS3 - View connected to a physical host and a logical host.

When you specify this option, the operating environment of the scheduler service is not output. When you specify this option together with `-F`, the `-F` option has no effect. In addition, if `ajsinetd` (network control process) is not running, connection information is not output.

-c

Specify this option to output the connection information of JP1/AJS3 - Web Console connected to JP1/AJS3 - Manager.

The connection information is information of JP1/AJS3 - Web Console connected to a physical host and a logical host.

When you specify this option, the operating environment of the scheduler service is not output. When you specify this option together with -F, the -F option has no effect. In addition, if `ajscdinetd` (JP1/AJS3 - Web Console control process) is not running, connection information is not output.

Arguments that can be specified when executing the command from JP1/AJS3 - View

You can specify the following arguments when executing the `ajslogprint` command from JP1/AJS3 - View:

| No. | Arguments | Required? |
|-----|------------------------------|-----------|
| 1 | <code>-F service-name</code> | Y |

Legend:

Y: Required

You cannot specify any other options when executing the `ajslogprint` command from JP1/AJS3 - View.

For details about how to execute JP1/AJS3 commands from JP1/AJS3 - View, see *10.4 Executing JP1/AJS3 commands from JP1/AJS3 - View* in the *JP1/Automatic Job Management System 3 Operator's Guide*.

Return values

| | |
|--|--------------|
| 0 | Normal end |
| Multiple of 4 within the range from 4 to 124 | Abnormal end |

Example1

The following command outputs the current operating environment for a scheduler service to the standard output file:

```
ajsstatus
```

Example2

The following command outputs the connection information of JP1/AJS3 - View connected to JP1/AJS3 - Manager to the standard output file.

```
ajsstatus -v
```

Example3

The following command outputs the connection information of JP1/AJS3 - Web Console connected to JP1/AJS3 - Manager to the standard output file.

```
ajsstatus -c
```

Output example 1

The following gives an output example of the current operating environment for a scheduler service, restrictions imposed on the output items, and the description of each output item.

Output example

| | | |
|------|--|--|
| (1) | Service name | AJSROOT1 |
| (2) | AJS status | active |
| (3) | Suppress function | Job execution |
| (4) | AJS start time | 20XX/08/01 10:25 |
| (5) | Termination restriction | schedule |
| (6) | Database type | ISAM |
| (7) | Database file install directory | /var/opt/ajs6/ajsroot |
| (8) | Table, File name | |
| | Unit management: | AJSUNIT |
| | Unit relation definition: | AJSARROW |
| | Unit definition: | AJSBODY |
| | Schedule definition: | AJSSCH |
| | Calendar definition: | AJSCAL |
| | Unit condition: | AJSSTAT |
| | Execution regist: | AJSENTRY |
| | Generation management: | AJSGEN |
| | Statistic information: | AJSPERF |
| (9) | Manager character code type | C |
| (10) | Job error information directory | /usr/lib/jp1_ajs/stderr |
| (11) | Backup information directory | /usr/lib/jp1_ajs/backup |
| (12) | AJS start/stop message output | none |
| (13) | Jobnet start/stop message output | all |
| (14) | Job start/stop message output | abend |
| (15) | Scheduler log file size | 100 KB |
| (16) | Scheduler log file in use | /usr/lib/jp1_ajs/log/ajs_log1 |
| (17) | Alternate scheduler log file | /usr/lib/jp1_ajs/log/ajs_log2 |
| (18) | AJS start/stop log output | all |
| (19) | Jobnet start/stop log output | all |
| (20) | Job start/stop log output | all |
| (21) | Operation log output | ALTER STOP ENTRY LEAVE PLAN INTRPT RERUN KILL CHANGE CALENDAR DELETE RESTORE DEFINE COPY CHGST SUSPEND IMPORT |
| (22) | A schedule of route job net | 24 hours |
| (23) | Suspend function | has an effect |
| (24) | Reference log output | BACKUP EXPORT NAME PRINT SCHEDULE SHOW |
| (25) | operation management for temp. changes | has no effect |

Restrictions on output items

- Items (4), (5), (16), and (17) are not displayed if the scheduler service has been terminated.
- Items (16) and (17) are not displayed in the following cases:
 - If the size of the scheduler log file is 0 in item (15)
 - If output of log data is disabled during environment setup (that is, 0 is specified for the LOGSIZE environment setting parameter)

Description of output items

(1) Service name

Indicates the name of the scheduler service.

(2) AJS status

Indicates whether operation with JP1/AJS3 has been started (whether the scheduler service is running).

active: Operation with JP1/AJS3 has been started.

inactive: Operation with JP1/AJS3 is stopped.

Maintenance: Operation with JP1/AJS3 is stopped.

(3) Suppress function

Indicates the status of the suppression function of JP1/AJS3.

Job execution: Suppresses the execution of a job.

none: Does not suppress the execution of a job.

(4) AJS start time

Indicates the date and time at which operation with JP1/AJS3 was started (the scheduler service was started).

(5) Termination restriction

Indicates that the `ajsstop` command has been used to terminate operation with JP1/AJS3.

schedule: The system is monitoring termination according to schedule restrictions.

jobnet: The system is monitoring termination according to jobnet restrictions.

job: The system is monitoring termination according to job restrictions.

none: The `ajsstop` command has not been executed.

forced stop: The system is stopped forcibly.

stop: The system is being stopped.

restricted stop: The termination restriction is being canceled.

(6) Database type

Indicates the database type.

ISAM: Stores information in an ISAM file.

EmbedDB: Stores information in an embedded database.

SQLSVR: Stores information in an external database (Microsoft SQL Server).

(7) Database file install directory

Indicates the name of the directory that stores the ISAM and unit lock files.

(8) Table, File name

For ISAM, indicates the name of the file that stores each piece of information (base name of the file).

For embedded database, indicates the name of the table that stores each piece of information.

(9) Manager character code type

Indicates the type of the character set used to store information in the database.

SJIS: Uses the Shift-JIS character set.

EUC: Uses the EUC character set

UTF-8: Uses the UTF-8 character set.

C: Uses the 7-bit ASCII character set.

Cautionary note

If Chinese is used, C is displayed.

(10) Job error information directory

Indicates the name of the job error information directory.

(11) Backup information directory

Indicates the name of the backup information directory.

(12) AJS start/stop message output

Indicates whether the system outputs the JP1/AJS3 operation start and end messages to the Windows event log or Syslog.

none: Outputs no messages.

all: Outputs all the messages.

(13) Jobnet start/stop message output

Indicates whether the system outputs the jobnet start and end messages to the Windows event log or Syslog.

none: Outputs no messages.

abend: Outputs only jobnet abnormal end messages.

warning: Outputs only jobnet warning end messages.

hold: Outputs only jobnet hold notification messages.

start_delay: Outputs only jobnet delayed start notification messages.

end_delay: Outputs only jobnet delayed end notification messages.

start_condition_monitor_start/end: Outputs only messages reporting the start or end of monitoring jobnet start conditions.

skipped so not exe.: Outputs only messages reporting the jobnet skipped so not exe. status.

preceding_unit_wait: Outputs messages relating to the wait condition of a jobnet, and wait condition hold notification messages

all: Outputs all messages (jobnet start and normal end messages, abnormal and warning end messages, hold notification messages, delayed start notification messages, delayed end notification messages, messages reporting the start or end of monitoring jobnet start conditions, messages reporting *skipped so not exe.* status, all unregistered jobnets, jobnet connector connection errors, and wait condition hold notification messages).

(14) Job start/stop message output

Indicates whether the system outputs the job start and end messages to the Windows event log or Syslog.

none: Outputs no messages.

abend: Outputs only job abnormal end messages.

warning: Outputs only job warning end messages.

hold: Outputs only job hold notification messages.

preceding_unit_wait: Outputs messages relating to the wait condition of a jobnet, and wait condition hold notification messages

retry_execution: Outputs only the automatic retry notification message when a job ends abnormally.

all: Outputs all messages (job start, normal end, abnormal end, end with warning, end-delay, wait condition hold notification messages, and automatic retry when a job ends abnormally).

(15) Scheduler log file size

Indicates the size of the scheduler log file (in kilobytes).

(16) Scheduler log file in use

Indicates the name of the scheduler log file that the scheduler service uses.

(17) Alternate scheduler log file

Indicates the name of the alternate scheduler log file to be used next when the log information output to the log file has reached the specified size.

(18) AJS start/stop log output

Indicates whether the system outputs log information when starting and ending operation with JP1/AJS3.

none: Outputs no logs.

all: Outputs all the logs.

(19) Jobnet start/stop log output

Indicates whether the system outputs log information when starting and ending a jobnet.

none: Outputs no logs.

abend: Outputs only jobnet abnormal end logs.

warning: Outputs only jobnet warning end logs.

hold: Outputs only jobnet hold notification logs.

start_delay: Outputs only jobnet delayed start notification logs.

end_delay: Outputs only jobnet delayed end notification logs.

start_condition_monitor_start/end: Outputs only logs reporting the start or end of monitoring jobnet start conditions.

skipped so not exe.: Outputs only logs reporting the jobnet skipped so not exe. status.

preceding_unit_wait: Outputs jobnet wait conditions and the retention history of the wait conditions.

all: Outputs all the logs (jobnet start, abnormal end, end with warning, hold notification, delayed start notification, delayed end notification, start condition monitoring start/end notification, skipped so not exe. notification, all unregistered jobnets, and wait condition hold notification messages).

(20) Job start/stop log output

Indicates whether the system outputs log information when starting and ending a job.

none: Outputs no logs.

abend: Outputs only job abnormal end logs.

warning: Outputs only job warning end logs.

hold: Outputs only job hold notification logs.

preceding_unit_wait: Outputs jobnet wait conditions and the retention history of the wait conditions.

retry_execution: Outputs only the automatic retry notification history when the job ends abnormally.

all: Outputs all the logs (job start, abnormal end, end with warning, end-delay, wait condition hold notification messages, and automatic retry when a job ends abnormally).

(21) Operation log output

Indicates whether the system outputs operation log information.

none: Outputs no logs.

ALTER: Outputs logs for operation with the `ajsalter` command.

STOP: Outputs logs for operation with the `ajsstop` command.

ENTRY: Outputs operation logs for registering jobnets for execution.

LEAVE: Outputs operation logs for canceling execution registration for jobnets.

PLAN: Outputs operation logs for temporarily modifying jobnet schedules.

INTRPT: Outputs operation logs for interrupting jobnet execution.

RERUN: Outputs operation logs for rerunning jobnets.

KILL: Outputs operation logs for killing jobs.

CHANGE: Outputs operation logs for modifying definition for units.

CALENDAR: Outputs operation logs for modifying calendar information.

DELETE: Outputs operation logs for deleting units.

RESTORE: Outputs operation logs for restoring units.

DEFINE: Outputs operation logs for manipulating definition for units.

COPY: Outputs operation logs for copying and moving units.

CHGST: Outputs operation logs for modifying the job status.

SUSPEND: Outputs logs of the jobnet's suspension operation and suspension canceled operation.

IMPORT: Outputs operation logs for importing units.

START: The operation log for the `ajsstart` command is output.

RGIMPORT: Operation log data related to importing of registration information is output.

RELEASE: Operation log data related to release information about the root jobnet is output.

all: Outputs all the logs.

(22) A schedule of route job net

Indicates the time system used in the schedule of root jobnet definition.

24 hours: Defines the schedule in a 24-hour schedule.

48 hours: Defines the schedule in a 48-hour schedule.

(23) Suspend function

Indicates whether the suspend function has an effect or not.

has an effect: Indicates that the suspend function is effective.

has no effect: Indicates that the suspend function is ineffective.

(24) Reference log output

Indicates whether the system outputs reference log information.

none: Outputs no reference log information.

BACKUP: Outputs reference logs for backing up units.

EXPORT: Outputs reference logs for exporting units.

NAME: Outputs reference logs for outputting names for units.

PRINT: Outputs reference logs for printing definitions for units.

SCHEDULE: Outputs reference logs for outputting schedule information for jobnets.

SHOW: Outputs reference logs for outputting status for units.

RELEASE: Outputs reference logs for release information about root jobnets.

RGEXPORT: Outputs reference logs for exporting registration information.

CALUTIL: Outputs reference logs for calendar calculations.

all: Outputs all the logs.

(25) operation management for temp. changes

Indicates whether the operation management for temp. changes has an effect or not.

has an effect: The operation management for temp. changes is effective.

has no effect: The operation management for temp. changes is ineffective.

Output example 2

The following gives an output example of the connection information of JP1/AJS3 - View connected to JP1/AJS3 - Manager, restrictions imposed on the output items, and the description of each output item.

Output example

| (1) Connection target scheduler service | (2) JP1 User | (3) Process ID | (4) Connection start date and time | (5) Connection source IP address | (6) Connection source host |
|--|-----------------|-------------------|---------------------------------------|-------------------------------------|-------------------------------|
| AJSROOT1 | jp1admin | 2085 | 20XX/04/25 13:25:35 | 133.108.132.1 | jp1host1 |
| AJSROOT1 | jp1admin | 2565 | 20XX/04/30 18:55:32 | 133.108.132.4 | jp1host2 |
| AJSROOT2 | jp1admin | 2811 | 20XX/05/15 18:55:32 | 133.108.132.1 | jp1host1 |
| AJSROOT3 | jp1admin | 6953 | 20XX/05/25 23:59:05 | 133.108.132.1 | jp1host1 |
| KAVS0832-I The View connection information output is complete. (7) | | | | | |

Restrictions on output items

If there is no connection information of JP1/AJS3 - View, or `ajsinetd` process has not been started, only the headers of items (1) to (6) and the message of items (7) are output.

Description of output items

(1) Connection target scheduler service

Indicates the name of the connected scheduler service. If the service name cannot be acquired because connection processing is being performed, `***` is output as the scheduler service name.

(2) JP1 user

Indicates the name of the JP1 user who has logged in to JP1/AJS3 - View.

(3) Process ID

Indicates the process ID of `ajsmnsvr` that manages the connection of JP1/AJS3 - View. All the output items on the same line are information about the process with this process ID. The output information exists for the period between the completion of login to JP1/AJS3 - View and logout from JP1/AJS3 - View.

(4) Connection start date and time

Indicates the date and time when the connection from JP1/AJS3 - View is started in the following format:

`YYYY/MM/DD hh:mm:ss`

The output format is the same for both Japanese and English environments. If the output number of digits for any of the items is insufficient, the beginning of the item is padded with zeros.

Example: 10 o'clock 2 minutes 5 seconds on July 1, 2010

`2010/07/01 10:02:05`

(5) Connection source IP address

Indicates the IP address of the host running JP1/AJS3 - View that is connected to JP1/AJS3 - Manager in the following format:

`xxx.xxx.xxx.xxx`

If the output number of digits for any of the segments is insufficient, the segment is left-justified.

Example: 133.108.132.1

`133.108.132.1`

(6) Connection source host

Outputs the host name converted from the IP address. If an IP address cannot be converted to a host name, the IP address is output as is. The host name is determined and output by performing a reverse lookup of the IP address of the connection source, which is JP1/AJS3 - View.

This host name might differ from the host name of the JP1/AJS3 - View host itself. In a DNS environment, the domain name is added to the original host name and the name is displayed in the FQDN format. If the IP address has alias host names and multiple host names are set for one IP address, the formal host name is displayed here.

(7) Message

A `KAVS0831-I` Cannot get View connection information because the JP1/AJS2 service is not started. message is output if the `ajsinetd` process has not been started.

In other cases, a `KAVS0832-I` The View connection information output is complete. message is output after all the information is output.

For details about how to start or stop the `ajsinetd` process separately, see *[jajs_hstd](#)* in 3. *Commands Used for Normal Operations* and *[jajs_hstd_stop](#)* in 3. *Commands Used for Normal Operations*.

Output example 3

The following gives an output example of the connection information of JP1/AJS3 - Web Console connected to JP1/AJS3 - Manager, restrictions imposed on the output items, and the description of each output item.

Output example

| (1) Connection target scheduler service | (2) JP1 User | (3) Process ID | (4) Connection start date and time | (5) Connection source IP address | (6) Connection source host |
|--|-----------------|-------------------|---------------------------------------|-------------------------------------|-------------------------------|
| AJSROOT1 | jp1admin | 2085 | 20XX/04/25 13:25:35 | 133.108.132.1 | jp1host1 |
| AJSROOT1 | jp1admin | 2565 | 20XX/04/30 18:55:32 | 133.108.132.4 | jp1host2 |
| AJSROOT2 | jp1admin | 2811 | 20XX/05/15 18:55:32 | 133.108.132.1 | jp1host1 |
| AJSROOT3 | jp1admin | 6953 | 20XX/05/25 23:59:05 | 133.108.132.1 | jp1host1 |
| KAVS4981-I The output of JP1/AJS3 - Software Development Kit connection information is complete. (7) | | | | | |

Restrictions on output items

If there is no connection information of JP1/AJS3 - Web Console, or `ajscdinetd` process has not been started, only the headers of items (1) to (6) and the message of items (7) are output.

Description of output items

(1) Connection target scheduler service

Indicates the name of the connected scheduler service. If the service name cannot be acquired because connection processing is being performed, `***` is output as the scheduler service name.

(2) JP1 user

Indicates the name of the JP1 user who has logged in.

(3) Process ID

Indicates the process ID of `ajsmossvr` that manages the connection. All the output items on the same line are information about the process with this process ID. The output information exists for the period between the completion of login and logout.

(4) Connection start date and time

Indicates the date and time when the connection is started in the following format:

`YYYY/MM/DD hh:mm:ss`

The output format is the same for both Japanese and English environments. If the output number of digits for any of the items is insufficient, the beginning of the item is padded with zeros.

Example: 10 o'clock 2 minutes 5 seconds on July 1, 2010

`2010/07/01 10:02:05`

(5) Connection source IP address

Indicates the IP address of the host that is connected to JP1/AJS3 - Manager in the following format:

`xxx.xxx.xxx.xxx`

If the output number of digits for any of the segments is insufficient, the segment is left-justified.

Example: `133.108.132.1`

`133.108.132.1`

(6) Connection source host

Reverse lookup is performed for the host name from the IP address of the host connecting with JP1/AJS3 - Manager, and the host name is output. If an IP address cannot be converted to a host name, the IP address is output as is.

The output host name might be different from the connection-source host name. In a DNS environment, the domain name is added, and the host name is output in FQDN format. If an alias host name that corresponds to the IP address exists, and multiple host names are set, the main host name is output.

(7) Message

A KAVS4982-I message is output if the ajscdinetd process has not been started.

In other cases, a KAVS4981-I message is output after all the information is output.

For details about how to start or stop the ajscdinetd process separately, see *jajs_hstd* in 3. *Commands Used for Normal Operations* and *jajs_hstd_stop* in 3. *Commands Used for Normal Operations*.

Output example 4

The following is an output example of the connection information of the external database connected to JP1/AJS3 - Manager, a description of the restrictions imposed on the output items, and a description of each output item.

Output example

| | | |
|------|--|--|
| (1) | Service name | AJSROOT1 |
| (2) | AJS status | active |
| (3) | Suppress function | Job execution |
| (4) | AJS start time | 20XX/08/01 10:25 |
| (5) | Termination restriction | none |
| (6) | Database type | SQLSVR |
| (7) | ODBC file data source name | /odbc/ajsdatasource.dsn |
| (8) | Database Name | AJSROOT1DB |
| (9) | Database file install directory | /var/opt/jp1ajs2/database/schedule/AJSROOT1 |
| (10) | Manager character code type | EUC |
| (11) | Job error information directory | /var/opt/jp1ajs2/jobinf |
| (12) | Backup information directory | /var/opt/jp1ajs2/backup/schedule |
| (13) | AJS start/stop message output | none |
| (14) | Jobnet start/stop message output | none |
| (15) | Job start/stop message output | none |
| (16) | Scheduler log file size | 10240 KB |
| (17) | Scheduler log file in use | /var/opt/jp1ajs2/log/schedule/AJSROOT1/ajs-log1.log |
| (18) | Alternate scheduler log file | /var/opt/jp1ajs2/log/schedule/AJSROOT1/ajs-log2.log |
| (19) | AJS start/stop log output | all |
| (20) | Jobnet start/stop log output | all |
| (21) | Job start/stop log output | all |
| (22) | Operation log output | all |
| (23) | A schedule of route job net | 24 hours |
| (24) | Suspend function | has no effect |
| (25) | Reference log output | all |
| (26) | operation management for temp. changes | has no effect |

Restrictions on output items

- Items (4), (5), (17), and (18) are not displayed if the scheduler service is not running.
- Items (17) and (18) are not displayed in the following cases:
 - The size of the scheduler log file in item (16) is 0.
 - The output of log information is disabled (specifically, 0 is specified for the LOGSIZE environment setting parameter) during environment setup.

Description of output items

(1) Service name

Indicates the name of the scheduler service.

(2) AJS status

Indicates whether operation with JP1/AJS3 has been started (whether the scheduler service is running).

active: Operation with JP1/AJS3 has been started.

inactive: Operation with JP1/AJS3 is stopped.

Maintenance: Operation with JP1/AJS3 is stopped.

(3) Suppress function

Indicates the status of the suppression function of JP1/AJS3.

Job execution: Suppresses the execution of a job.

none: Does not suppress the execution of a job.

(4) AJS start time

Indicates the date and time at which operation with JP1/AJS3 was started (the scheduler service was started).

(5) Termination restriction

Indicates that the `ajsstop` command has been used to terminate operation with JP1/AJS3.

schedule: The system is monitoring termination according to schedule restrictions.

jobnet: The system is monitoring termination according to jobnet restrictions.

job: The system is monitoring termination according to job restrictions.

none: The `ajsstop` command has not been executed.

forced stop: The system is stopped forcibly.

stop: The system is being stopped.

restricted stop: The termination restriction is being canceled.

(6) Database type

Indicates the database type.

ISAM: Stores information in an ISAM file.

EmbedDB: Stores information in an embedded database.

SQLSVR: Stores information in an external database (Microsoft SQL Server).

(7) ODBC file data source name

Indicates the ODBC file data source name used for connecting to the external database. This item is output only when the database type is `SQLSVR`.

(8) Database name

Indicates the name of the external database that stores scheduler service information. This item is output only when the database type is `SQLSVR`.

(9) Database file install directory

Indicates the name of the directory that stores the ISAM and unit lock files.

(10) Manager character code type

Indicates the type of the character set used to store information in the database.

SJIS: Uses the Shift-JIS character set.

EUC: Uses the EUC character set

UTF-8: Uses the UTF-8 character set.

C: Uses the 7-bit ASCII character set.

Cautionary note

If Chinese is used, C is displayed.

(11) Job error information directory

Indicates the name of the job error information directory.

(12) Backup information directory

Indicates the name of the backup information directory.

(13) AJS start/stop message output

Indicates whether the system outputs the JP1/AJS3 operation start and end messages to the Windows event log or Syslog.

none: Outputs no messages.

all: Outputs all the messages.

(14) Jobnet start/stop message output

Indicates whether the system outputs the jobnet start and end messages to the Windows event log or Syslog.

none: Outputs no messages.

abend: Outputs only jobnet abnormal end messages.

warning: Outputs only jobnet warning end messages.

hold: Outputs only jobnet hold notification messages.

start_delay: Outputs only jobnet delayed start notification messages.

end_delay: Outputs only jobnet delayed end notification messages.

start_condition_monitor_start/end: Outputs only messages reporting the start or end of monitoring jobnet start conditions.

skipped so not exe.: Outputs only messages reporting the jobnet skipped so not exe. status.

preceding_unit_wait: Outputs messages relating to the wait condition of a jobnet, and wait condition hold notification messages

all: Outputs all messages (jobnet start and normal end messages, abnormal and warning end messages, hold notification messages, delayed start notification messages, delayed end notification messages, messages reporting the start or end of monitoring jobnet start conditions, messages reporting *skipped so not exe.* status, all unregistered jobnets, jobnet connector connection errors, and wait condition hold notification messages).

(15) Job start/stop message output

Indicates whether the system outputs the job start and end messages to the Windows event log or Syslog.

none: Outputs no messages.

abend: Outputs only job abnormal end messages.

warning: Outputs only job warning end messages.

hold: Outputs only job hold notification messages.

preceding_unit_wait: Outputs messages relating to the wait condition of a jobnet, and wait condition hold notification messages

retry_execution: Outputs only the automatic retry notification message when a job ends abnormally.

all: Outputs all messages (job start, normal end, abnormal end, end with warning, end-delay, wait condition hold notification messages, and automatic retry when a job ends abnormally).

(16) Scheduler log file size

Indicates the size of the scheduler log file (in kilobytes).

(17) Scheduler log file in use

Indicates the name of the scheduler log file that the scheduler service uses.

(18) Alternate scheduler log file

Indicates the name of the alternate scheduler log file to be used next when the log information output to the log file has reached the specified size.

(19) AJS start/stop log output

Indicates whether the system outputs log information when starting and ending operation with JP1/AJS3.

none: Outputs no logs.

all: Outputs all the logs.

(20) Jobnet start/stop log output

Indicates whether the system outputs log information when starting and ending a jobnet.

none: Outputs no logs.

abend: Outputs only jobnet abnormal end logs.

warning: Outputs only jobnet warning end logs.

hold: Outputs only jobnet hold notification logs.

start_delay: Outputs only jobnet delayed start notification logs.

end_delay: Outputs only jobnet delayed end notification logs.

start_condition_monitor_start/end: Outputs only logs reporting the start or end of monitoring jobnet start conditions.

skipped so not exe.: Outputs only logs reporting the jobnet skipped so not exe. status.

preceding_unit_wait: Outputs jobnet wait conditions and the retention history of the wait conditions.

all: Outputs all the logs (jobnet start, abnormal end, end with warning, hold notification, delayed start notification, delayed end notification, start condition monitoring start/end notification, skipped so not exe. notification, all unregistered jobnets, and wait condition hold notification messages).

(21) Job start/stop log output

Indicates whether the system outputs log information when starting and ending a job.

none: Outputs no logs.

abend: Outputs only job abnormal end logs.

warning: Outputs only job warning end logs.

hold: Outputs only job hold notification logs.

preceding_unit_wait: Outputs jobnet wait conditions and the retention history of the wait conditions.

retry_execution: Outputs only the automatic retry notification history when the job ends abnormally.

all: Outputs all the logs (job start, abnormal end, end with warning, end-delay, wait condition hold notification messages, and automatic retry when a job ends abnormally).

(22) Operation log output

Indicates whether the system outputs operation log information.

none: Outputs no logs.

ALTER: Outputs logs for operation with the `ajsalter` command.

STOP: Outputs logs for operation with the `ajsstop` command.

ENTRY: Outputs operation logs for registering jobnets for execution.

LEAVE: Outputs operation logs for canceling execution registration for jobnets.

PLAN: Outputs operation logs for temporarily modifying jobnet schedules.

INTRPT: Outputs operation logs for interrupting jobnet execution.

RERUN: Outputs operation logs for rerunning jobnets.

KILL: Outputs operation logs for killing jobs.

CHANGE: Outputs operation logs for modifying definition for units.

CALENDAR: Outputs operation logs for modifying calendar information.

DELETE: Outputs operation logs for deleting units.
RESTORE: Outputs operation logs for restoring units.
DEFINE: Outputs operation logs for manipulating definition for units.
COPY: Outputs operation logs for copying and moving units.
CHGST: Outputs operation logs for modifying the job status.
SUSPEND: Outputs logs of the jobnet's suspension operation and suspension canceled operation.
IMPORT: Outputs operation logs for importing units.
START: The operation log for the `ajsstart` command is output.
RGIMPORT: Operation log data related to importing of registration information is output.
RELEASE: Operation log data related to release information about the root jobnet is output.
all: Outputs all the logs.

(23) A schedule of route job net

Indicates the time system used in the schedule of root jobnet definition.
24 hours: Defines the schedule in a 24-hour schedule.
48 hours: Defines the schedule in a 48-hour schedule.

(24) Suspend function

Indicates whether the suspend function has an effect or not.
has an effect: Indicates that the suspend function is effective.
has no effect: Indicates that the suspend function is ineffective.

(25) Reference log output

Indicates whether the system outputs reference log information.
none: Outputs no reference log information.
BACKUP: Outputs reference logs for backing up units.
EXPORT: Outputs reference logs for exporting units.
NAME: Outputs reference logs for outputting names for units.
PRINT: Outputs reference logs for printing definitions for units.
SCHEDULE: Outputs reference logs for outputting schedule information for jobnets.
SHOW: Outputs reference logs for outputting status for units.
RELEASE: Outputs reference logs for release information about root jobnets.
RGEXPORT: Outputs reference logs for exporting registration information.
CALUTIL: Outputs reference logs for calendar calculations.
all: Outputs all the logs.

(26) operation management for temp. changes

Indicates whether the operation management for temp. changes has an effect or not.
has an effect: The operation management for temp. changes is effective.
has no effect: The operation management for temp. changes is ineffective.

ajsstop

Format

```
ajsstop
  [-F service-name]
  [-s | -n | -j | -k | -c | -r]
  [-f]
  [-w]
```

Description

Terminates the JP1/AJS3 scheduler service.

You must terminate the scheduler service in the following cases:

- When terminating scheduler service operation as planned
- When restoring a database
- When modifying any environment setting parameter

This command also cancels any schedule restriction or jobnet restriction, previously requested by this command, to return the operation to the original status.

Execution privileges

In Windows: Administrators privilege

In UNIX: Superuser privilege

Arguments

-F *service-name*

Specify the name of the target scheduler service.

You can specify a character string of 1 to 30 bytes.

If you omit this option, the system assumes the default scheduler service name.

-s

Terminates the scheduler service after all jobnets that are scheduled to execute on the day on which the command is executed are terminated (this is called *schedule restriction*).

The following examples show the termination of a scheduler service when a jobnet registered for execution belongs to a job group in which a base time has been set. In the examples, jobnets to be executed are marked "E" while those not to be executed are marked with "N".

Example 1:

Job group A:

Base time: 9:00

Scheduler service started at 9:00

Jobnet to be executed at 12:00 and 7:00

Command entered at 10:00

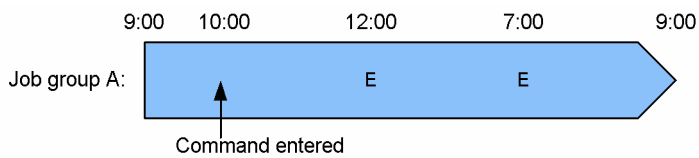

Example 2:

Job group A:

Base time: 10:00

Scheduler service started at 10:00

Jobnet to be executed at 12:00 and 7:00

Command entered at 9:00

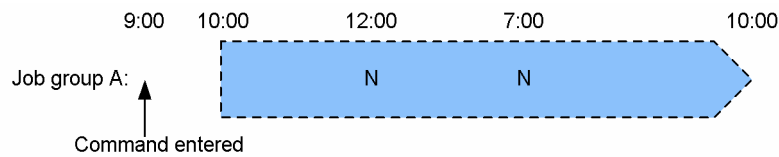

Example 3:

Job group A:

Base time: 9:00

Scheduler service started at 9:00

Jobnet to be executed at 12:00 and 7:00

Job group B:

Base time: 11:00

Scheduler service started at 11:00

Jobnet to be executed at 13:00 and 9:00

Command entered at 10:00

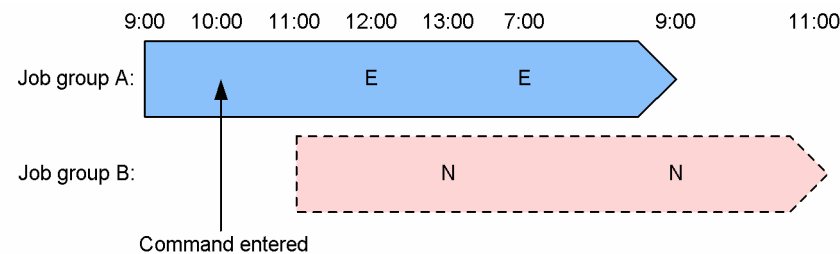

Example 4:

Job group A:

Base time: 9:00

Scheduler service started at 9:00

Jobnet to be executed at 12:00 and 7:00

Job group B:

Base time: 10:00

Scheduler service started at 10:00

Jobnet to be executed at 13:00 and 8:00

Command entered at 11:00

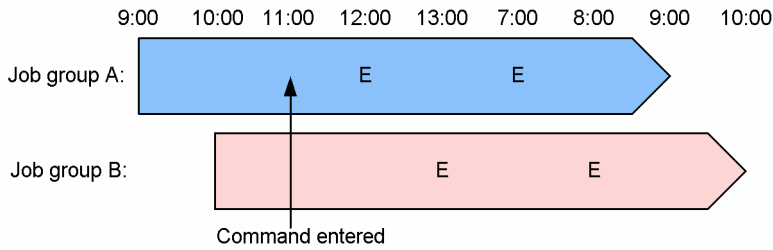

If the scheduled date of jobnet execution is shifted to the date on which the command is entered, the system handles the jobnet as a jobnet executed on the date on which the command is entered.

Monitored generations of a jobnet with a start condition that are in *Now monitoring* status enter *Interrupted monitoring* status after all jobnets scheduled for execution on the day on which the command is executed have terminated. If the wait condition of a monitored jobnet that is subject to schedule restriction is met while the generation is still in *Now monitoring* status, the jobnet is executed.

-n

Terminates the scheduler service after all the jobnets that are running when the command is entered are terminated. (This is called *jobnet restriction*.)

A jobnet that is subject to schedule restriction will not start executing when:

- The start time is reached
- The previous generation ends when the jobnet is in *Wait for prev. to end* status
- The start condition of a unit with a start condition is satisfied[#]

#

Execution generations generated when a start condition is met during schedule restriction are executed after you use this command with the `-r` option to cancel the schedule restriction, or you restart the scheduler service.

Monitored generations of a jobnet with start conditions that are in *Now monitoring* status enter *Interrupted monitoring* status after all jobnets running when the command is executed have ended.

-j

Terminates the scheduler service after all the jobs that are running and jobnet connectors that are in a running status[#] when the command is entered are terminated. (This is called *job restriction*.) The effect on running root jobnets is the same as if you interrupted the root jobnet.

#

A running status here refers to any of the following statuses:

- Now running
- Running + Warning
- Running + Abend

A jobnet that is subject to schedule restriction will not start executing when:

- The start time is reached
- The previous generation ends when the jobnet is in *Wait for prev. to end* status
- The start condition of a jobnet with a start condition is satisfied[#]

#

Execution generations generated when a start condition is met during job restriction are executed after you restart the scheduler service.

Monitored generations of a jobnet with start conditions that are in *Now monitoring* status enter *Interrupted monitoring* status immediately when the command is entered.

-k

Terminates the scheduler service immediately when the command is entered. This option causes the system to kill all the jobs that are running when the scheduler service is terminated. (This process is called *forced termination (kill) of jobs*.) The effect on running root jobnets is the same as if you killed the root jobnet.

A jobnet that is subject to forced job termination will not start executing when:

- The start time is reached
- The previous generation ends when the jobnet is in *Wait for prev. to end* status
- The start condition of a jobnet with a start condition is satisfied[#]

#

Execution generations generated when a start condition is met for a job killed by forced job termination are executed after you restart the scheduler service.

Generations of a jobnet with start conditions that are in *Now monitoring* status enter *Interrupted monitoring* status immediately when the command is entered.

-c

Terminates the scheduler service immediately when the command is entered. This option, however, allows the system to continue all the jobs that are running when the service is terminated. (This process is called *forced termination (kill) of the scheduler service*.)

You can specify this option to kill all processes quickly, preventing the scheduler service process from being killed, when you want to stop the system in emergency.

-r

Cancels any schedule restriction (*-s* option) or jobnet restriction (*-n* option) applied, to return the operation to the original status.

-f

Accepts a request to stop the scheduler service even in the following status, in which no normal stop request can be accepted:

- Start processing of the scheduler service requested to start is in progress

You cannot specify this option together with the *-s*, *-n*, *-j*, or *-r* option.

You must specify this option together with the *-c* or *-k* option.

If you execute the command without specifying the *-f* option before the scheduler service requested to start becomes up and running, an error occurs.

-w

Specify this option to terminate the command when the scheduler service completely stops. If you specify this option together with the `-r` option, the command terminates when the schedule restriction or the jobnet restriction is completely canceled.

Notes

- This command terminates abnormally if you execute it when a scheduler service is not running.
- You cannot cancel a job restriction (you can cancel schedule and jobnet restrictions using the `-r` option).
- The system performs restriction processing before starting termination processing for the scheduler service. You cannot cancel restrictions after the system starts termination processing. You can view the current status using the `ajsstatus` command.
- To insure the stop of the scheduler service, specify the `-w` option. (If you omit the `-w` option, the `ajsstop` command terminates immediately after issuing a stop request to the scheduler service. The execution of the next command may, therefore, start before the processing for stopping the scheduler service is completed.)
- If a jobnet connector is used to control the execution order of jobnets, then, depending on the status of the connection-destination jobnet, the jobnet connector might be placed in a running status.[#] If the jobnet connector is placed in a running status, the root jobnet that includes the jobnet connector is also placed in a running status. In this case, you cannot restrict how the scheduler service stops. If this situation occurs, stop the scheduler service by specifying the `-k` or `-c` option, or by changing the status of the jobnet connector.

A running status here refers to any of the following statuses:

- Now running
 - Running + Warning
 - Running + Abend
- This note applies when a jobnet connector is used to control the execution order of root jobnets. When the `-j` option is specified, if the connection-destination root jobnet contains a unit that is waiting for the preceding unit to end, the status of the root jobnet that contains the jobnet connector does not change from *Now running*. In this case, you cannot stop the scheduler service. If this situation occurs, stop the scheduler service by specifying the `-k` or `-c` option.
 - You cannot rerun a job or jobnet that is subject to job restriction or forced job termination.
 - You cannot perform automatic retry on abnormal end for a job that is subject to job restriction or forced job termination. The job enters an end status without retry execution regardless of the return code or the number of retry executions.
 - If you perform forced job termination while a large number of remote jobnets are running, a lack of desktop heap resources might cause termination of the remote jobnets to fail and prevent the scheduler service from stopping. When there is a large number of active remote jobnets, terminate the remote jobnets before you perform forced job termination.
 - The system cannot terminate a suspended root jobnet. To stop the scheduler service, you must release any suspended root jobnets before executing the command.
 - You cannot execute this command together with any of the following commands on the same logical host:
 - `ajsprofalter` command
 - `ajsembdbstart` command
 - `ajsembdbstop` command
 - `jajs_hstd` command
 - `jajs_hstd_stop` command
 - `jajs_spmc` command (if the `-n` value is not `jajs_schd`)

`jajs_spmd_status` command

`jajs_spmd_stop` command (if the `-n` value is not `jajs_schd`)

`jajs_start` command (UNIX only)

`jajs_start.cluster` command (UNIX only)

`jajs_stop` command (UNIX only)

`jajs_stop.cluster` command (UNIX only)

- You cannot execute this command together with any of the following commands if the same scheduler service is specified:

`ajsstart` command

`ajsstop` command

`jajs_spmd` command (if the `-n` value is `jajs_schd`)

`jajs_spmd_stop` command (if the `-n` value is `jajs_schd`)

Return values

| | |
|--|--------------|
| 0 | Normal end |
| Multiple of 4 within the range from 4 to 124 | Abnormal end |

Example

The following command terminates the scheduler service after the currently running service is terminated:

```
ajsstop -n
```

ajssuspend

Format

```
ajssuspend
  [-F service-name]
  {-S [-n] | -C [-r|-h|-p] | -U}
  [-R]
  [-E]
  [-T]
  root-jobnet-name-or-job-group-name...
```

Description

Suspends a root jobnet. This command also releases the suspension of a root jobnet.

Execution privileges

You must have any of the following JP1 privileges:

- JP1_AJS_Admin privilege
- JP1_AJS_Manager privilege
- JP1_AJS_Operator privilege

Arguments

-F *service-name*

Specify the service name of the corresponding scheduler service.

You can specify a character string of 1 to 30 bytes.

-S

Suspends a root jobnet.

However, any root jobnet as the target will not be suspended if it is being executed. If you suspend a root jobnet being currently executed, you must specify this with the **-n** option.

-n

Suspends a root jobnet being currently executed.

By default, the root jobnet being executed will not be suspended.

-C

Cancel the suspension of the root jobnet.

When suspending a root jobnet being executed and adding units under the root jobnet, you can specify the **-r**, **-h**, or **-p** option to determine how the additional units will be handled after the suspension is canceled. Without the **-r**, **-h**, or **-p** option specified, the root jobnet being executed and all the units added below the root jobnet will be executed after the suspension is canceled.

-r

Executes a unit added during the state of suspension after the suspension is canceled.

-h

Holds a unit added during the state of suspension after the suspension is canceled.

-p

Does not execute a unit added during the state of suspension after the suspension is canceled.

-U

Deletes any ineffective unit records remaining in a database.

-R

Suspends a specified root jobnet or all the jobnets contained in a job group, or cancels the suspension.

If you specify this option with the **-E** and/or **-T** options, the system suspends the target jobnets or cancels the suspension according to the specification of each option.

-E

Suspends a root jobnet registered for execution, or cancels the suspension.

-T

Suspends a root jobnet, or cancels the suspension.

root-jobnet-name-or-job-group-name

Specify the name of the root jobnet you want to suspend. You can also specify a jobnet name or job group name with the **-R**, **-E**, or **-T** option.

You can specify a character string of 1 to 930 bytes.

You can specify more than one root jobnet name or job group name. Note that you cannot specify a manager jobnet name or manager job group name.

You can specify a logical host name as the root jobnet name or job group name. You cannot specify an execution ID.

Notes

- Either of the following users can suspend the root jobnet or cancel the suspend status:
 - A user granted the operation privilege when the jobs and jobnets contained in the root jobnet were defined or when their attributes were changed.
 - A JP1 user mapped to the OS user who has Administrators or superuser privileges
Note, however, that if `yes` is set after changing the `ADMACLIMIT` environment setting parameter from its default, even a JP1 user who was mapped to an OS user who has Administrators or superuser privileges must have the operation privilege.
- This command terminates abnormally if the scheduler service is not running.
- Only a root jobnet can be suspended/de-suspended.
- This command terminates abnormally if a jobnet to be suspended is monitoring start conditions.
- This command terminates abnormally if a root jobnet to be suspended has already been suspended.

- This command terminates abnormally if a root jobnet to be suspended is currently in the suspension process.
- This command terminates abnormally if a root jobnet to be suspended has already been de-suspended.
- This command terminates abnormally if a root jobnet to be suspended is currently in the de-suspension process.

Return values

| | |
|--|--------------|
| 0 | Normal end |
| Multiple of 4 within the range from 4 to 124 | Abnormal end |

Additional information

This command terminates only after a root jobnet becomes suspended. It also terminates only after the suspension is canceled.

Example 1

The following command suspends the jobnet (`net1`).

```
ajssuspend -S net1
```

Example 2

The following command cancels a root jobnet (`net1`) being suspended. Because the root jobnet was being executed before the suspension, it continues its execution after it is de-suspended. However, units have been added during suspension will be held.

```
ajssuspend -C -h net1
```

ajssysctlstart (UNIX only)

Format

For JP1/AJS3 - Manager

```
ajssysctlstart
  [-m]
  [-a]
```

For JP1/AJS3 - Agent

```
ajssysctlstart
  [-a]
```

Description

Starts the JP1/AJS3 System Control Manager service or the JP1/AJS3 System Control Agent service.

Execution privileges

Superuser privileges

Storage directory

/opt/jp1ajs2/bin/

Arguments

-m

Starts the JP1/AJS3 System Control Manager service.

The **-m** option can be specified only in JP1/AJS3 - Manager. It cannot be specified with JP1/AJS3 - Agent.

-a

Starts the JP1/AJS3 System Control Agent service.

Notes

- If you omit all options, the following options are assumed:
 - JP1/AJS3 - Manager: **-m**, **-a**
 - JP1/AJS3 - Agent: **-a**
- Before executing this command, make sure that the Management Portal execution environment has been set up. If the Management Portal execution environment has not been set up, set it up by using the `ajssysctlsetup` command.
- This command applies only to UNIX. You cannot use this command in Windows.
- This command terminates without waiting for completion of the startup of the service. To confirm whether the service has started, execute the `ajssysctlstatus` command.

Return values

| | |
|---|------------|
| 0 | Normal end |
|---|------------|

| | |
|---------------------|--------------|
| Values other than 0 | Abnormal end |
|---------------------|--------------|

ajssysctlstatus

Format

For JP1/AJS3 - Manager

```
ajssysctlstatus
  [-m]
  [-a]
  [-e]
```

For JP1/AJS3 - Agent

```
ajssysctlstatus
  [-a]
  [-e]
```

Description

The `ajssysctlstatus` command outputs detailed information about the JP1/AJS3 System Control Manager service or the JP1/AJS3 System Control Agent service.

Execution privileges

None

Storage directory

In Windows:

JP1/AJS3 - Manager-installation-folder\bin

JP1/AJS3 - Agent-installation-folder\bin

In UNIX:

/opt/jp1ajs2/bin/

Arguments

-m

Displays information about the JP1/AJS3 System Control Manager service.

The `-m` option can be specified only in JP1/AJS3 - Manager. It cannot be specified with JP1/AJS3 - Agent.

-a

Displays information about the JP1/AJS3 System Control Agent service.

-e

Displays information about the operating environment of the service specified by the `-m` or `-a` option (information about the environment setting parameters that take effect during operation). If neither option is specified, the command does not display the information.

For details about environment setting parameter, see *20.15 Management Portal execution environment* in the *JP1/Automatic Job Management System 3 Configuration Guide*.

Notes

- If you omit all options, the following options are assumed:
 - JP1/AJS3 - Manager: -m, -a
 - JP1/AJS3 - Agent: -a
- If this command is used to obtain information about the JP1/AJS3 System Control Manager service or JP1/AJS3 System Control Agent service, the command does it by communicating with the local host via TCP/IP according to the JP1/Base physical host communication settings. Therefore, if the IP address corresponding to the local host name (shown by the `hostname` command) can be used to communicate with another host, the command might obtain service information from the other host.

If you execute the command in this environment, beforehand, set the `hosts`, `DNS`, `jplhosts`, or `jplhosts2` file so that the local host name can resolve into the local host IP address.

For details about the `jplhosts` or `jplhosts2` file, see the *JP1/Base User's Guide*.

Return values

| | |
|----------------------|--------------|
| 0 | Normal end |
| A value other than 0 | Abnormal end |

Output example

```
(1) <JP1/AJS3 System Control Manager Service>
(2) Service status                active
(3) Service start time           2022/06/24 14:52:30
(4) Maximum number of concurrent operations 5
(5) Number of operations currently running 2
(6) Maximum number of concurrent aggregation processes 5
(7) Current number of concurrent aggregation processes 3

(8) <JP1/AJS3 System Control Agent Service>
(9) Service status                active
(10) Service start time           2022/06/24 14:52:33
(11) Maximum number of concurrent operations 5
(12) Number of operations currently running 2

(13) <JP1/AJS3 Sysrem Control Manager Service environment information>
[JP1_DEFAULT¥JP1AJS2¥CONTROL]
AUTHSYSLOG                        "none"
SYSLOGCODE                        "C"
[JP1_DEFAULT¥JP1AJS2¥CONTROL¥MANAGER]
CONRESTRICTSYSLOG                "none"
AJSSYSCTLDLOGSIZE                dword:00000080
LOGSIZE                           dword:00002800
MAXOPEEXEC                       dword:00000005
MAXAGGEXEC                       dword:00000005
JOBAGGTIMEOUT                    dword:0000003C

(14) <JP1/AJS3 Sysrem Control Agent Service environment information>
[JP1_DEFAULT¥JP1AJS2¥CONTROL]
AUTHSYSLOG                        "none"
SYSLOGCODE                        "C"
[JP1_DEFAULT¥JP1AJS2¥CONTROL¥AGENT]
AJSSYSCTLDLOGSIZE                dword:00000080
LOGSIZE                           dword:00002800
MAXOPEEXEC                       dword:00000005
```

Explanation of the displayed items

The details about each displayed item are explained here. The parentheses for individual display items refer to the output format applicable when C is used for the value of the LANG environment variable for OS users executing the command in UNIX.

The command displays information items in the order (1) to (14) as follows.

(1) - (7):

Displays information about the JP1/AJS3 System Control Manager service.

The command displays the following items if the `-m` option is specified explicitly or implicitly:

(1) <JP1/AJS3 System Control Manager Service>

Displays a character string indicating the title of the information about the JP1/AJS3 System Control Manager service.

(2) Service status

Displays the operating status of the JP1/AJS3 System Control Manager service.

`active`: The JP1/AJS3 System Control Manager service is running.

`inactive`: The JP1/AJS3 System Control Manager service is stopped.

`stop processing...`: The JP1/AJS3 System Control Manager service cannot accept any requests because it is being stopped.

(3) Service start time

If `Status` is `active`, the time at which the JP1/AJS3 System Control Manager service started is displayed in the `yyyy/mm/dd hh:mm:ss` format.

If `Status` is `inactive`, `**** ** ** *: **: **` is output.

(4) Maximum number of concurrent operations

Displays the maximum number of operation requests from clients that can concurrently be processed by the JP1/AJS3 System Control Manager service.

If `Status` is `inactive`, `-` is output.

(5) Number of operations currently running

Displays the number of operation requests from clients that are currently being processed by the JP1/AJS3 System Control Manager service.

If `Status` is `inactive`, `-` is output.

(6) Maximum number of concurrent aggregation processes

Displays the maximum number of threads that can concurrently run to perform aggregation requested by a client for the JP1/AJS3 System Control Manager service.

If `Status` is `inactive`, `-` is output.

(7) Current number of concurrent aggregation processes

Displays the number of threads that are currently running concurrently to perform aggregation requested by a client for the JP1/AJS3 System Control Manager service.

If `Status` is `inactive`, `-` is output.

(8) - (12):

Displays information about the JP1/AJS3 System Control Agent service.

The command displays the following items if the `-a` option is specified explicitly or implicitly:

(8) <JP1/AJS3 System Control Agent Service>

Displays a character string indicating the title of the information about the JP1/AJS3 System Control Agent service.

(9) Service status

Displays the operating status of the JP1/AJS3 System Control Agent service.

- `active`: The JP1/AJS3 System Control Agent service is running.
- `inactive`: The JP1/AJS3 System Control Agent service is stopped.
- `stop processing...`: The JP1/AJS3 System Control Agent service cannot accept any requests because it is being stopped.

(10) Service start time

If `Status` is `active`, the time at which the JP1/AJS3 System Control Agent service started is displayed in the `yyyy/mm/dd hh:mm:ss` format.

If `Status` is `inactive`, `**** ** ** **: **: **` is output.

(11) Maximum number of concurrent operations

Displays the maximum number of operation requests from clients that can concurrently be processed by the JP1/AJS3 System Control Agent service.

If `Status` is `inactive`, `-` is output.

(12) Number of operations currently running

Displays the number of operation requests from clients that are currently being processed by the JP1/AJS3 System Control Agent service.

If `Status` is `inactive`, `-` is output.

(13) - (14):

Displays information about the environment setting parameters for each service.

If the `-e` option is specified, the following items are displayed, according to the option specified in combination with the `-e` option.

- (13): Information about the environment setting parameters for the JP1/AJS3 System Control Manager service
The command displays the following items if the `-m` option is specified explicitly or implicitly:
- (14): Information about the environment setting parameters for the JP1/AJS3 System Control Agent service
The command displays the following items if the `-a` option is specified explicitly or implicitly:

(13) <JP1/AJS3 System Control Manager Service environment information>

Displays information about the environment setting parameters for the following definition keys used by the JP1/AJS3 System Control Manager service:

- [JP1_DEFAULT\JP1AJS2\CONTROL]
- [JP1_DEFAULT\JP1AJS2\CONTROL\MANAGER]

If the corresponding environment setting parameters are not specified, their default values are displayed.

This information is displayed only when the `-e` option is specified.

(14) <JP1/AJS3 System Control Agent Service environment information>

Displays information about the environment setting parameters for the following definition keys used by the JP1/AJS3 System Control Agent service:

- [JP1_DEFAULT\JP1AJS2\CONTROL]
- [JP1_DEFAULT\JP1AJS2\CONTROL\AGENT]

If the corresponding environment setting parameters are not specified, their default values are displayed. This information is displayed only when the `-e` option is specified.

ajssysctlstop (UNIX only)

Format

For JP1/AJS3 - Manager

```
ajssysctlstop
  [-m]
  [-a]
```

For JP1/AJS3 - Agent

```
ajssysctlstop
  [-a]
```

Description

Stops the JP1/AJS3 System Control Manager service or the JP1/AJS3 System Control Agent service.

Execution privileges

Superuser privileges

Storage directory

/opt/jp1ajs2/bin/

Arguments

-m

Stops the JP1/AJS3 System Control Manager service.

The **-m** option can be specified only in JP1/AJS3 - Manager. It cannot be specified with JP1/AJS3 - Agent.

-a

Stops the JP1/AJS3 System Control Agent service.

Notes

- If you omit all options, the following options are assumed:
 - JP1/AJS3 - Manager: **-m**, **-a**
 - JP1/AJS3 - Agent: **-a**
- Before executing this command, make sure that the Management Portal execution environment has been set up and the JP1/AJS3 System Control Manager service or the JP1/AJS3 System Control Agent service is running. If the Management Portal execution environment has not been set up, set it up by using the `ajssysctlsetup` command.
- If the target service is processing a client's operation request, the service stops without waiting until the requested processing ends.
- This command stops immediately when a stop request is sent to the JP1/AJS3 System Control Manager service or the JP1/AJS3 System Control Agent service. Therefore, you cannot check whether the service was stopped successfully from the execution results of this command. To check whether the service was stopped, use the `ajssysctlstatus` command.

- If this command is used to stop the JP1/AJS3 System Control Manager service or JP1/AJS3 System Control Agent service, the command does it by communicating with the local host via TCP/IP according to the JP1/Base physical host communication settings. Therefore, if the IP address corresponding to the local host name (shown by the `hostname` command) can be used to communicate with another host, the command might stop the service on the other host.

If you execute the command in this environment, beforehand, set the `hosts`, `DNS`, `jp1hosts`, or `jp1hosts2` file so that the local host name can resolve into the local host IP address.

For details about the `jp1hosts` or `jp1hosts2` file, see the *JP1/Base User's Guide*.

Return values

| | |
|----------------------|--------------|
| 0 | Normal end |
| A value other than 0 | Abnormal end |

ajstrsetsz

Format

```
ajstrsetsz
  [-F scheduler-service-name]
  [-s size]
```

Description

Changes or references the size of the current trace log file or the trace log file for a specified scheduler service.

If you execute this command, without specifying any arguments, the system outputs the size of the current trace log file to the standard output file.

Execution privileges

In Windows: Administrators privilege

In UNIX: Superuser privilege

Arguments

-F *scheduler-service-name*

Specify the service name of the scheduler service for which the trace log file is to be processed.

You can specify a character string of 1 to 30 bytes.

You can specify this option only if the value of the environment setting parameter `TRACELOGDIV` is `yes`.

If you specify this option, the trace log file for the specified scheduler service is subject to processing. The trace log file for the scheduler service is output to the folder specified in the environment setting parameter `TRACELOGDIVDIR`.

If you omit this option, the trace log file that has the path name specified in the environment setting parameter `TRACELOGFILE` is subject to processing.

-s *size*

Specify the size of a trace log file.

You can specify a value between 64 and 2,097,151 (kilobytes).

If you omit this option, the size of the current trace log file or the trace log files for individual scheduler services is output to the standard output file.

Notes

- If you use this command to reduce the size of a trace log file, the contents of the trace log file before resizing are deleted.
- Always separate the option and its value by at least one space character.
- For a cluster operation, execute this command on the primary and secondary nodes to make the sizes of the trace log files on both nodes the same.

Return values

| | |
|--|--------------|
| 0 | Normal end |
| Multiple of 4 within the range from 4 to 124 | Abnormal end |

Example 1

The following command changes the size of the trace log file from the default to 3 megabytes (3,072 kilobytes).

```
ajstrsetsz -s 3072
```

Example 2

The following command increases the size of the trace log file for AJSROOT2 (among the scheduler services that are running concurrently) from the default to 3 megabytes (3,072 kilobytes) .

```
ajstrsetsz -F AJSROOT2 -s 3072
```

Example 3

Outputs the size of the currently selected trace log to the standard output file.

```
ajstrsetsz
```

Output example:

```
SIZE:64KB
```

Example 4

The following command outputs the size of the trace log file for AJSROOT2 (among the scheduler services that are running concurrently) to the standard output file.

```
ajstrsetsz -F AJSROOT2
```

Output example:

```
SIZE:3072KB
```

ajswbtz (Linux only)

Format

```
ajswbtz
```

Description

Outputs the time zone ID that can be specified for the environment settings file of the Web Console server.

The following information is output:

- Time zone ID
- Offset time to be added to UTC (without daylight saving time)
- Name of time zone

Execution privileges

None

Storage directory

```
/opt/jp1ajs3web/tools/
```

Arguments

None

Note

This command applies only to Linux. You cannot use this command in Windows.

Return values

| | |
|---------------------|--------------|
| 0 | Normal end |
| Values other than 0 | Abnormal end |

Output example

The following shows an output example.

```
time zone ID          GMT offset  name
Etc/GMT+12           -12:00    GMT-12:00
Etc/GMT+11           -11:00    GMT-11:00
Pacific/Midway        -11:00    Samoa Standard Time
Pacific/Niue          -11:00    Niue Time
Pacific/Pago_Pago    -11:00    Samoa Standard Time
Pacific/Samoa        -11:00    Samoa Standard Time
US/Samoa              -11:00    Samoa Standard Time
America/Adak          -10:00    Hawaii-Aleutian Standard Time
America/Atka          -10:00    Hawaii-Aleutian Standard Time
:
GMT                   00:00     Greenwich Mean Time
```

:
Pacific/Kiritimati +14:00 Line Is. Time

ajswbtz.bat (Windows only)

Format

```
ajswbtz.bat
```

Description

Outputs the time zone ID that can be specified for the environment settings file of the Web Console server.

The following information is output:

- Time zone ID
- Offset time to be added to UTC (without daylight saving time)
- Name of time zone

Execution privileges

None

Storage directory

JP1/AJS3 - Web Console-installation-folder\tools

Arguments

None

Note

This command applies only to Linux. You cannot use this command in Windows.

Return values

| | |
|---------------------|--------------|
| 0 | Normal end |
| Values other than 0 | Abnormal end |

Output example

The following shows an output example.

```
time zone ID          GMT offset  name
Etc/GMT+12           -12:00    GMT-12:00
Etc/GMT+11           -11:00    GMT-11:00
Pacific/Midway       -11:00    Samoa Standard Time
Pacific/Niue         -11:00    Niue Time
Pacific/Pago_Pago    -11:00    Samoa Standard Time
Pacific/Samoa        -11:00    Samoa Standard Time
US/Samoa             -11:00    Samoa Standard Time
America/Adak         -10:00    Hawaii-Aleutian Standard Time
America/Atka         -10:00    Hawaii-Aleutian Standard Time
:
GMT                  00:00    Greenwich Mean Time
```

:
Pacific/Kiritimati +14:00 Line Is. Time

jajs_dbbackup

Format

```
jajs_dbbackup
  [-id embedded-database-setup-ID]
  -o backup-data-storage-directory
  [-t time]
```

Description

Creates a backup of the data of an embedded database while JP1/AJS3 is running. The backup data is stored in the backup data storage directory that is specified for the `-o` option.

This command is available when the backup enhancement function is enabled.

This command is available when the embedded database is active.

Execution privileges

In Windows: Administrators privilege

In UNIX: Superuser privilege

Arguments

`-id embedded-database-setup-ID`

Use four characters, `_JFn` (*n* is 0 to 9 or A to Z), to specify the setup identifier of the embedded database to be backed up. Specify the value specified in the `-id` option of the `ajsembdbbuild` command.

If you omit this option, the system assumes `_JF0`.

`-o backup-data-storage-directory`

Specify the directory that stores the backup data. Use an absolute path to specify the directory. In Windows, to include space characters in the specified absolute path, enclose the path in double quotation marks ("").

You can specify a character string of 1 to 200 bytes. In UNIX, you cannot specify the root directory.

The backup data is output to the following directory, which is located in the directory specified for this option. Note that `YYYYMMDD_hhmmss` in the directory name means *year-month-day_hour-minute-second*.

In Windows

```
Backup-date-storage-directory\BK embedded-database-setup-ID_YYYYMMDD_hhmmss
```

In UNIX

```
Backup-date-storage-directory/BK embedded-database-setup-ID_YYYYMMDD_hhmmss
```

`-t time`

Specify the timeout value for backup processing. The specified value applies to backup processing, and is not the timeout value for the command execution as a whole.

You can specify a value between 1 and 1,440 for the minute.

The default is 10 minute.

If the backup processing does not terminate within the specified time, the `jajs_dbbackup` command terminates abnormally.

Space requirements for the backup data storage directory

The amount of free space required for the backup file storage directory differs depending on the embedded database model as shown in the following table.

Table 3–26: Embedded database models and the required free space

| Database model | Required free space |
|----------------|---------------------|
| Large scale | About 7,200 MB |
| Medium scale | About 1,900 MB |
| Small scale | About 700 MB |

If the database area has been expanded by using the `ajsembdbaddarea` command, additional free space equivalent to the area added by the expansion is required. Similarly, if the database auto-increment function is enabled, additional free space equivalent to the area added by the function is required.

For details about the database auto-increment function, see 23.2 *Estimating the database area* in the *JP1/Automatic Job Management System 3 Configuration Guide*.

Notes

- Job execution is suspended while this command is being executed. Therefore, executing this command might cause a delay in the jobnet start time or end time. To minimize the impact on job operation, execute this command when no jobs are to be executed.
- If the `jajs_dbbackup` command is executed during job execution, the command might terminate abnormally. If the `jajs_dbbackup` command terminates abnormally, re-execute it when no jobs are being executed.
- During backup processing, the following operations on the embedded database to be backed up and scheduler services that run in that embedded database are paused until backup processing terminates:
 - Starting a scheduler service
 - Executing a command that operates a unit defined in the scheduler service
 - Operating a scheduler service from JP1/AJS3 - View
 - Executing a command that operates the embedded database
 - Executing a remote jobnet defined in the scheduler service (executive host)
 - Executing a remote jobnet defined in the scheduler service (execution target host)
 - Operating a scheduler service from JP1/AJS3 - Web Console
 - Adding, deleting, or changing an execution agent or an execution agent group[#]
#: If the agent management database is stored in the embedded database to be backed up.
- The `jajs_dbbackup` command might terminate abnormally if operation is being performed on the embedded database to be backed up or its scheduler service by using JP1/AJS3 - View, the JP1/AJS3 - Web Console, or another command. If the `jajs_dbbackup` command terminated abnormally, make sure that no operation is being performed on the embedded database or scheduler services that run in the embedded database, and then re-execute the `jajs_dbbackup` command.

- To cancel the backup being performed, use the procedure in 2.5.2(4) *Canceling the processing to back up the embedded database* in the *JP1/Automatic Job Management System 3 Administration Guide*.
- If you execute this command as a job, you cannot cancel the backup by performing any of the following operations:
 - Forcibly terminating a running job or jobnet
 - Interrupting a running jobnet

If you perform these operations, backup is not canceled according to the timeout setting. To cancel the backup being performed, use the procedure in 2.5.2(4) *Canceling the processing to back up the embedded database* in the *JP1/Automatic Job Management System 3 Administration Guide*.

- Do not execute this command in an environment in which the JP1/AJS3 service does not start normally. If the backup data created in such a JP1/AJS3 environment is used for recovery, a problem might occur in the recovery environment.
- If you continuously use this command for backup with the same backup data storage directory specified, free space on the disk that contains the backup data storage directory might become insufficient. Periodically delete unnecessary backup data in the backup data storage directory to prevent a shortage of disk space.

Return values

| | |
|---------------------|--------------|
| 0 | Normal end |
| Values other than 0 | Abnormal end |

Backup information file (backupinfo.txt)

When backup processing ends normally, this command outputs a backup information file (`backupinfo.txt`) to the backup data.

The following shows an output example of the backup information file. (`backupinfo.txt`).

```
[SETUP-ID]
_JF0

[BACKUP START TIME]
2019/06/25 00:00:00

[BACKUP END TIME]
2019/06/25 00:05:00

[BACKUP RESULT]
SUCCEEDED
```

The following shows the meaning of the output.

[SETUP-ID]

Indicates the setup identifier of the embedded database whose backup was created.

[BACKUP START TIME]

Indicates the time when the backup started.

[BACKUP END TIME]

Indicates the time when the backup ended.

[BACKUP RESULT]

Indicates the end status of the backup.

The following shows the statuses that can be displayed:

| End status | Meaning |
|------------|----------------------|
| SUCCEEDED | Normal termination |
| FAILED | Abnormal termination |

When you recover data by using the `jajs_dbrestore` command, you can use backup data for which `SUCCEEDED` is displayed for this item.

Example

The following command backs up the embedded database (`_JF0`), and then stores the backup in the backup data storage directory (`/backup`).

```
jajs_dbbackup -id _JF0 -o /backup
```

jajs_dbrestore

Format

```
jajs_dbrestore  
  [-id embedded-database-setup-ID]  
  -i backup-data
```

Description

Restores an embedded database by using backup data that was created by using the `jajs_dbbackup` command.

This command is available when the backup enhancement function is enabled.

After the embedded database is restored by using this command, the scheduler service that runs on the restored embedded database starts in disaster recovery mode only for the first time after recovery. In disaster recovery mode, job execution is suppressed and the statuses of jobs and jobnets change. For details on disaster recovery mode, see *6.2.1 Temporarily changing the start mode of JP1/AJS3* in the *JP1/Automatic Job Management System 3 Administration Guide*.

Execution privileges

In Windows: Administrators privilege

In UNIX: Superuser privilege

Arguments

-id *embedded-database-setup-ID*

Use four characters, `_JFn` (n is 0 to 9 or A to Z), to specify the setup identifier of the embedded database to be restored. For this option, specify the value that was specified in the `-id` option of the `jajs_dbbackup` command when the backup data to be specified for the `-i` option was created. To check the value specified in the `-id` option of the `jajs_dbbackup` command, see the backup information file (`backupinfo.txt`) contained in the backup data.

If you omit this option, the system assumes `_JF0`.

If the value specified for this option does not match the embedded database setup identifier described in the backup information file in the backup data to be specified for the `-i` option, the command terminates abnormally.

-i *backup-data*

Specify the directory containing the backup data that was output by the `jajs_dbbackup` command. Use an absolute path to specify the backup data. In Windows, to include space characters in the specified absolute path, enclose the path in double quotation marks (`"`).

You can specify a character string of 1 to 223 bytes.

If you specify the backup data that was incorrectly output as a result of, for example, the abnormal termination of the `jajs_dbbackup` command, the command terminates abnormally. To check whether the backup data was normally output, you can use the backup information file (`backupinfo.txt`) contained in the backup data.

Notes

- When this command is executed, all execution result details of units and temporary change information for the scheduler services that run in the embedded database of the specified setup identifier are deleted.

- Before executing this command, make sure that the embedded database is stopped.
- Do not execute multiple instances of this command concurrently on the same host. If you do so, any subsequently executed commands terminate abnormally.
- If an error occurs during the execution of this command, the database is returned to the status before the command was executed. In this case, however, database recovery might be incomplete. If an error occurs, correct the cause of the error without starting JP1/AJS3, and then perform restore again.
- If an error occurs during the restoration of an embedded database, the database area of the embedded database might be blocked. If you re-execute `ajajs_dbrestore` command in this status, an error occurs. In such a case, execute the following command for the embedded database to release the blocked status of the database area. After the blocked status is released, execute the `ajajs_dbrestore` command to restore the embedded database:

1. Check the status of the target embedded database.

```
ajsembdbstatus -s ust -id embedded-database-setup-ID
```

2. If the target embedded database is running, stop it normally.

```
ajsembdbstop -id embedded-database-setup-ID
```

3. Start the target embedded database.

```
ajsembdbstart -id embedded-database-setup-ID
```

4. Set the environment variables required to execute commands for the embedded database.

For details about the environment variables you must set, see the table that describes them in *9.2.3(2) Using a script to reorganize the database* in the *JP1/Automatic Job Management System 3 Administration Guide*.

5. Release the blocked status of the database area.

```
pdrels -r ALL -o
```

6. Stop the target embedded database normally.

```
ajsembdbstop -id embedded-database-setup-ID
```

- To delete the environment of the embedded database, re-create the environment of the embedded database, and then restore the data, complete `ajsembdbsetup` command, and then execute `ajsembdbrestore` command.

If the embedded database area has been expanded by using the `ajsembdbaddarea` command, the same expansion is also necessary before you execute the `ajsembdbrestore` command.

The expansion procedure is as follows.

In Windows:

1. Back up the following folder:

```
embedded-database-practical-folder#\CONF\embrm
```

2. Execute the `ajsembdbunset` command.

3. Execute the `ajsembdbbuild` command.

4. Execute the `ajsembdbsetup` command.

5. In the folder you backed up in step 1, rename the `addarea` file to `addarea.bat`, and then execute the file.

6. Change the name of the file you renamed in step 5 back to `addarea`.

7. Restore the folder you backed up in step 1 to the following folder:

```
embedded-database-practical-folder#\CONF
```

8. Delete the folder you backed up in step 1.

9. Recovering data of the embedded database.

For details, see *2.5.3(2) Recovering data of the embedded database in the JP1/Automatic Job Management System 3 Administration Guide*.

In UNIX:

1. Back up the following directory:
embedded-database-practical-directory#/conf/embrm
2. Execute the `ajsembdbunset` command.
3. Execute the `ajsembdbbuild` command.
4. Execute the `ajsembdbsetup` command.
5. In the folder you backed up in step 1, add execute permission to the access permissions of the `addarea` file, and then execute the file.
6. Restore the directory you backed up in step 1 to the following directory:
embedded-database-practical-directory#/conf
7. Delete the directory you backed up in step 1.
8. Recovering data of the embedded database.
For details, see *2.5.3(2) Recovering data of the embedded database in the JP1/Automatic Job Management System 3 Administration Guide*.

You can check the embedded database practical folder or directory by using the `ajsembdbidlist` command.
For details on the `ajsembdbidlist` command, see *ajsembdbidlist* in *2. Commands Used during Setup*.

- Do not execute this command concurrently with the following commands on the same logical host:
 - `ajsprofalter` command
 - `ajsembdbstart` command
 - `ajsembdbstop` command
 - `ajsstart` command
 - `ajsstop` command
 - `jajs_hstd` command
 - `jajs_hstd_stop` command
 - `jajs_spmd` command
 - `jajs_spmd_status` command
 - `jajs_spmd_stop` command
 - `jajs_start` command (UNIX only)
 - `jajs_start.cluster` command (UNIX only)
 - `jajs_stop` command (UNIX only)
 - `jajs_stop.cluster` command (UNIX only)

Return values

| | |
|---------------------|--------------|
| 0 | Normal end |
| Values other than 0 | Abnormal end |

Example

The following command restores the embedded database (_JF0) by using the backup data (/BK_JF0_20190101_000000) in the backup data storage directory (/backup).

```
jajs_dbrestore -id _JF0 -i /backup/BK_JF0_20190101_000000
```

jajs_extdb

Format

```
jajs_extdb
  [-v | -p | -r]
  [-F scheduler-service-name | -a]
  [-y]
```

Format1 (for displaying the connection information of the external database)

```
jajs_extdb
  [-v]
```

Format2 (for setting a combination of connections between JP1/AJS3 - Manager and the database on an external database)

```
jajs_extdb
  -p
  {-F scheduler-service-name | -a}
  [-y]
```

Format3 (for canceling the execution-suppression startup status for a scheduler service)

```
jajs_extdb
  -r
  -F scheduler-service-name
```

Description

You can use this command if you are using an external database to operate JP1/AJS3.

The command performs the following processing according to the specified options:

- Displays the connection information of the external database connected to JP1/AJS3 - Manager.
- Sets a connection relation between JP1/AJS3 - Manager and the database on an external database.
- Cancels the execution-suppression startup status for a scheduler service after recovering the database from a system error.

Execution privileges

In Windows: Administrators privilege

In Linux: Superuser privilege

Arguments

-v

Displays the connection information of the external database.

You can specify this option regardless of the status of the JP1/AJS3 service.

If you specify this option at the same time as the `-p` or `-r` option, the command terminates abnormally.

-p

Sets a connection relation between JP1/AJS3 - Manager and the database on the external database after recovering JP1/AJS3 - Manager or external database from a system error.

When you execute the command, a message asking you whether you want to set the connection relation appears. Enter `y` or `Y` to set the connection relation, or enter any other character (including `n`) to cancel.

If you specify this option with the `-a` option, the command sets the connection relation between JP1/AJS3 - Manager and the agent management database.

If you specify this option with the `-F` option, the command sets the connection relation between the scheduler service specified in the `-F` option and the database on the external database. The target scheduler is also placed in the execution-suppression startup status. Disaster recovery starts are performed for JP1/AJS3 services that are in the execution-suppression start status. For details about performing a disaster recovery start, see *6.2.1 Temporarily changing the start mode of JP1/AJS3* in the *JP1/Automatic Job Management System 3 Administration Guide*.

To cancel the execution-suppression start status, run the command with the `-r` option specified.

If you specify this option at the same time as the `-v` or `-r` option, the command terminates abnormally.

If JP1/AJS3 - Manager is not connected to an external database (if you are using the embedded database in a standard configuration), the command terminates abnormally.

-r

Cancels the execution-suppression start status for the scheduler service specified in the `-F` option.

If you specify this option at the same time as the `-v` or `-p` option, the command terminates abnormally.

-F scheduler-service-name

Specify the name of the scheduler service for which you want to perform the desired operation (addition, renaming, or deletion).

You can specify a character string of 1 to 30 bytes.

You must specify this option with the `-p` or `-r` options.

If you specify this option at the same time as the `-v` or `-a` option, the command terminates abnormally.

-a

Specifies the agent management database as the target of setting a connection relation by using the `-p` option.

You must specify this option with the `-p` options.

If you specify this option at the same time as the `-v`, `-r` or `-F` option, the command terminates abnormally.

-y

Specify this option if you do not want to output a message that confirms execution of the command when a connection relation is set by using the `-p` option.

You must specify this option with the `-p` options.

If you specify this option at the same time as the `-v` or `-r` option, the command terminates abnormally.

Notes

- Do not execute this command repeatedly in quick succession.
- You can execute this command only for a manager host or scheduler service that uses an external database. If you execute the command for an agent management database or scheduler database that does not use an external database, the command terminates abnormally.
- Do not forcibly terminate this command during execution.
- If you specify the `-p` option, the command forcibly sets a connection relation between a database and JP1/AJS3 - Manager or scheduler service even if the database is already in use. If you specify the `-p` option, confirm the target database for setting a connection relation before you execute the command.
- Before specifying the `-p` option, make sure that the JP1/AJS3 service is not running.
- You can execute this command only for a physical host or for scheduler services that are set up on a physical host.

Return values

| | |
|---------------------|--------------|
| 0 | Normal end |
| Values other than 0 | Abnormal end |

Example 1

The following command displays information about the physical host, information about the agent management database on an external database, and the connection information for all scheduler databases.

```
jajs_extdb -v
```

Example 2

The following command sets a connection relation between JP1/AJS3 - Manager and the database of the scheduler service (AJSROOT1).

```
jajs_extdb -p -F AJSROOT1
```

Example 3

The following command sets a connection relation between JP1/AJS3 - Manager and the database of the scheduler service (AJSROOT2) without displaying a message that confirms execution of the command.

```
jajs_extdb -p -F AJSROOT2 -y
```

Example 4

The following command sets a connection relation between JP1/AJS3 - Manager and the agent management database on an external database.

```
jajs_extdb -p -a
```

Example 5

The following command cancels the execution-suppression start status for the scheduler service (AJSROOT1).

```
jajs_extdb -r -F AJSROOT1
```

Output example

The following shows a sample execution of the command with the `-v` option specified:

```
(1) Host                JP1_DEFAULT
(2) Database Type      SQLSVR

(3) Agent management
(4)  Status            ENABLE
(5)  ODBC File Data Source Name /odbc/ajsdatasource.dsn
(6)  Database Name     AJSROOT1DB

(7) Scheduler Service  AJSROOT1
(8)  Status            ENABLE
(5)  ODBC File Data Source Name /odbc/ajsdatasource.dsn
(6)  Database Name     AJSROOT1DB

(7) Scheduler Service  AJSROOT2
(8)  Status            ENABLE
(5)  ODBC File Data Source Name /odbc/ajsdatasource2.dsn
(6)  Database Name     AJSROOT2DB
```

The output items are as follows:

(1) Host

Indicates the physical host name (JP1_DEFAULT).

(2) Database Type

Indicates the database type of the database used on the external database.

- When Microsoft SQL Server is used: SQLSVR

(3) Agent management

Indicates the item name.

(4) Status

Indicates the status of the agent management database on the external database.

The status to be displayed is as follows:

| No. | Status | Meaning |
|-----|-----------------|---|
| 1 | ENABLE | Available as the agent management database. |
| 2 | DISABLE | Not available as the agent management database. A connection relation between JP1/AJS3 - Manager and the agent management database must be set. |
| 3 | NOT CONNECTABLE | A connection with the target database cannot be established. |

(5) ODBC File Data Source Name

Indicates the ODBC file data source name to be used.

(6) Database Name

Indicates the database name to be used.

(7) Scheduler Service

Indicates the name of the scheduler service.

(8) Status

Indicates the status of the scheduler database on the external database.

The status to be displayed is as follows:

| No. | Status | Meaning |
|-----|-----------------|---|
| 1 | ENABLE | Available as a scheduler database. |
| 2 | DISABLE | Not available as a scheduler database. A connection relation between JP1/AJS3 - Manager and the scheduler database must be set. |
| 3 | SUPPRESS | JP1/AJS3 is started in the execution-suppression start status because the connection between JP1/AJS3 - Manager and the database was set up with the <code>-p</code> option specified. To start job operation, you need to: <ul style="list-style-type: none">• Execute the <code>jajs_extdb -r</code> command to cancel the execution-suppression start status.• Execute the <code>ajsalter -s none</code> command to cancel the suppression of job execution. |
| 4 | NOT CONNECTABLE | A connection with the target database cannot be established. |

jajs_hstd

Format

```
jajs_hstd  
  [-h logical-host-name]  
  -n detail-process-name
```

Description

The `jajs_hstd` command starts a separate detailed process of the host service management function (`jajs_hstd`).

Execution privileges

In Windows: Administrators privilege

In UNIX: Superuser privileges

Arguments

-h *logical-host-name*

In a cluster system, specify the name of the logical host on which you want to start the host service.

You can specify a character string of 1 to 255 bytes.

By default, the system assumes the logical host name specified by the `JP1_HOSTNAME` environment variable. If environment variable `JP1_HOSTNAME` is not specified, the physical host name (which can be determined by the `hostname` command) is assumed.

-n *detail-process-name*

Specify the name of the detailed process you want to start. You can specify any of the process names listed in the following table.

| Detailed process to be started | Detailed process name to be specified in the -n option | |
|--------------------------------|--|----------------|
| | Windows | UNIX |
| ajshlogd | Hlogd | ajshlogd |
| ajsinetd | Ajsinetd | ajsinetd |
| ajsnetwd | Network | ajsnetwd |
| ajsagtmd | Agentm | ajsagtmd |
| ajsovstatd | Ajsovstatd | ajsovstatd |
| ajsgwmasterd | Gatewayd | ajsgwmasterd |
| jpgman# | Submitqueue | jpgman_hst |
| jpomanager | Hostevam | jpomanager_hst |
| ajscdinetd | Ajscdinetd | ajscdinetd |
| ajsagtmnd | Agentmon | ajsagtmnd |

In the case of HP-UX, AIX, and Linux, the detailed process name is `jpqman32`.

Notes

- Before you execute this command, make sure that JP1/AJS3 is running.
- When `ajsrcmdsvr.exe` is running in Windows, after the `ajsinetd` process is individually stopped by the `jajs_hstd_stop` command, if the process is individually started by that command, the KAVS0903-E or KAVS0904-E message is output to the integrated trace log by the `ajsinetd` process, and then the process might fail to start. In this case, take the following actions:

For physical hosts:

Using the task manager, make sure that no JP1/AJS3 command processes remain. If a command process remains, wait until the command is completed, or start the `ajsinetd` process individually after forcibly terminating the commands by using the task manager. If no command process remains, follow the actions described in the message that was output.

For logical hosts:

Using the task manager, make sure that no JP1/AJS3 command process remains. If a command process remains, wait until the command is completed, or start the JP1/AJS3 service after forcibly terminating the command processes by using the task manager. If no command process remains, follow the actions described in the message that was output.

- You cannot execute this command together with any of the following commands on the same logical host:

`jajs_hstd` command
`jajs_hstd_stop` command
`jajs_spmd` command
`jajs_spmd_status` command
`jajs_spmd_stop` command
`jajs_start` command (UNIX only)
`jajs_start.cluster` command (UNIX only)
`jajs_stop` command (UNIX only)
`jajs_stop.cluster` command (UNIX only)

- In Windows, this command cannot be executed using short file names.

Return values

| | |
|---------------------|---------------|
| 0 | Normal end. |
| Values other than 0 | Abnormal end. |

Example

The following command starts the network control process (`ajsinetd`) on logical host `lhost1`.

```
jajs_hstd -h lhost1 -n ajsinetd
```

jajs_hstd_stop

Format

```
jajs_hstd_stop  
  [-h logical-host-name]  
  -n detail-process-name
```

Description

The `jajs_hstd_stop` command stops a separate detailed process of the host service management function (`jajs_hstd`).

Execution privileges

In Windows: Administrators privilege

In UNIX: Superuser privileges

Arguments

-h *logical-host-name*

In a cluster system, specify the name of the logical host on which you want to stop the host service.

You can specify a character string of 1 to 255 bytes.

By default, the system assumes the logical host name specified by the `JP1_HOSTNAME` environment variable. If environment variable `JP1_HOSTNAME` is not specified, the physical host name (which can be determined by the `hostname` command) is assumed.

-n *detail-process-name*

Specify the name of the detailed process you want to stop. You can specify any of the process names listed in the following table.

| Detailed process to be stopped | Detailed process name to be specified in the -n option | |
|--------------------------------|--|----------------|
| | Windows | UNIX |
| ajshlogd | Hlogd | ajshlogd |
| ajsinetd | Ajsinetd | ajsinetd |
| ajsnetwd | Network | ajsnetwd |
| ajsagtmd | Agentm | ajsagtmd |
| ajsovstatd | Ajsovstatd | ajsovstatd |
| ajsgwmasterd | Gatewayd | ajsgwmasterd |
| jpgman# | Submitqueue | jpgman_hst |
| jpomanager | Hostevam | jpomanager_hst |
| ajscdineta | Ajscdineta | ajscdineta |
| ajsagtmond | Agentmon | ajsagtmond |

In the case of HP-UX, AIX, and Linux, the detailed process name is `jpqman32`.

Notes

- Before you execute this command, make sure that JP1/AJS3 is running.
- By stopping `ajsinetd` separately, you can forcibly disconnect JP1/AJS3 - View from the scheduler service running on the specified logical host.
- To terminate the `ajsinetd` process individually in Windows, use the task manager to make sure that `ajsrcmdsvr.exe` is not running, and then terminate the `ajsinetd` process. If `ajsrcmdsvr.exe` is running, the termination of the `ajsinetd` process might be delayed, or the process might fail to restart.
- By stopping `ajscdinetd` separately, you can forcibly disconnect access of the JP1/AJS3 - Web Console that is connected to the scheduler service on the specified logical host.
- Independently terminating a detailed process other than `ajsinetd` or `ajscdinetd` must be done only when a failure needs to be addressed. Normally, if a detailed process of the host service management function (`jajs_hstd`) is stopped, operation might be affected. For example, you might no longer be able to execute jobs.
- You cannot execute this command together with any of the following commands on the same logical host:
 - `jajs_hstd` command
 - `jajs_hstd_stop` command
 - `jajs_spmd` command
 - `jajs_spmd_status` command
 - `jajs_spmd_stop` command
 - `jajs_start` command (UNIX only)
 - `jajs_start.cluster` command (UNIX only)
 - `jajs_stop` command (UNIX only)
 - `jajs_stop.cluster` command (UNIX only)
- In Windows, this command cannot be executed using short file names.

Return values

| | |
|---------------------|---------------|
| 0 | Normal end. |
| Values other than 0 | Abnormal end. |

Example

The following command stops the network control process (`ajsinetd`) on logical host `lhost1`.

```
jajs_hstd_stop -h lhost1 -n ajsinetd
```

jajs_killall.cluster (UNIX only)

Format

```
jajs_killall.cluster  
    [logical-host-name]
```

Description

Forcibly terminates the JP1/AJS3 process during operation on a cluster system.

An attempt to execute the `jajs_stop.cluster` command at a failover may fail to stop the process, sometimes resulting in an unsuccessful failover. This command should be executed only when you want to forcibly stop a process that will not stop.

Execution privileges

Superuser privilege

Storage directory

/etc/opt/jp1ajs2/

Arguments

logical-host-name

Specify the name of the logical host that is set in JP1/Base.

You can specify a character string of 1 to 32 bytes.

By default, the system assumes the host name specified in the `JP1_HOSTNAME` environment variable. (The first 32 bytes of the logical host name are valid.) With this option omitted, the command terminate abnormally if the `JP1_HOSTNAME` environment variable contains nothing.

Notes

- This command applies only to UNIX. You cannot use this command in Windows.
- This command should be executed only when an attempt to execute the `jajs_stop.cluster` command fails to stop the process.
- When a request to forcibly stop the JP1/AJS3 process is issued, the shared disk might be disconnected from JP1/AJS3. If this occurs, change the log output destination of the shell script for forcibly stopping JP1/AJS3 (`jajs_killall.cluster`) to the log file storage directory on the physical host before you execute the shell script. The following shows how you can modify the shell script.

Before modification:

```
LOGDIR=`jbsgetcnf -h "$JP1_HOSTNAME" | grep '^"JP1AJS2_LOGDIR="' | \  
    sed -e 's/^[^=]*=//' -e 's/^"' -e 's/"$//' \  
COMNAME=`basename "$0"`
```

After modification:

```
LOGDIR="/var/opt/jplajs2/log" #Changed to log file storage directory on p
hysical host
COMNAME=`basename "$0"`
```

Return values

| | |
|---------------------|--------------|
| 0 | Normal end |
| Values other than 0 | Abnormal end |

Additional information

- This command is stored in the `/etc/opt/jplajs2/` path.
- This command forcibly terminates the process on a logical host basis. Of the JP1/AJS3 processes, however, those listed below are out of the target of forced termination.

| Process name | Description |
|--------------|--|
| jpocwtmqmai | MQ monitor process at the time of MQSeries linkage |

The processes in the table do not need a failover together with the JP1/AJS3 service. You can terminate a process, as necessary.

- This command outputs log information to a file. The system keeps five generations of the log file.

The default log file storage directory and file names are as follows:

Log file storage directory

shared-directory/jplajs2/log

(or `/var/opt/jplajs2/log` if you changed the output destination to the log file storage directory on the physical host)

Log file name:

`jajs_killall.cluster_logical-host-name.{1|2|3|4|5}.log`

jajs_log or _04 (UNIX only)

Format

```
jajs_log | _04
  [-h logical-host-name]
  [-f storage-directory]
  [-s]
  [-t]
  [-u]
  [-e]
  [-b]
  [additional-file]
```

Description

The data collection tool obtains maintenance information, such as the JP1/AJS3 definitions, operating information, and information about the OS.

`jajs_log` and `_04` have the same basic functionality. Use either tool depending on the purpose of use and whether customization is required.

The following table describes the purpose of `jajs_log` and `_04`, and whether they can be customized.

Table 3–27: Purpose of data collection tools and whether they can be customized

| Data collection tool | Purpose | Customization |
|-----------------------|---|---------------|
| <code>jajs_log</code> | Use this tool if the log output destinations have not been changed from the defaults, or if you need to collect data by default only. | N |
| <code>_04</code> | Customize this tool before using it if you have changed log output destinations from the defaults, or if you need to collect data other than the default data. [#] | Y |

Legend:

Y: The tool can be customized.

N: The tool cannot be customized.

#

For details about the customization method, see *16.1.1 Setting up the data collection tools* in the *JP1/Automatic Job Management System 3 Configuration Guide*.

By default, the results of executing the data collection tool are output to the following files under `/tmp/jp1ajs2/trouble/`.

For physical hosts:

1. `JP1_DEFAULT_1st.tar.Z`
The data for the first reports is output.
2. `JP1_DEFAULT_2nd.tar.Z`
The data for the second reports is output.
3. `JP1_DEFAULT_3rd.tar.Z`
All the other data is output.

For logical hosts:

1. `logical-host-name_1st.tar.Z`

The data for the first reports is output.

2. *logical-host-name_2nd.tar.Z*

The data for the second reports is output.

3. *logical-host-name_3rd.tar.Z*

All the other data is output.

Estimation of the size of information collected by the data collection tool

The following shows the formula for estimating the size of information that the data collection tool will collect when it is executed with the option to collect all information. Note that the estimation formula requires you to sum the sizes of directories and files. The summation method is explained later.

- When collecting data for a physical host

```
size-of-data-in-physical-host-environment#1 x 3
```

- When collecting data for a logical host

```
(size-of-data-in-physical-host-environment#1 + size-of-data-in-logical-host-environment#2) x 3
```

#1

This parameter is the total size of the following directories and files. If multiple products installed in the same environment have the following directories and files, obtain the total size of the directories and files for all of those products.

1. Integrated trace logs information

/var/opt/hitachi/HNTRLib2/spool

2. Log files information

For JP1/AJS3 - Manager or JP1/AJS3 - Agent:

/var/opt/jp1ajs2/log

For JP1/AJS3 - Web console:

/var/opt/jp1ajs3web/log

3. System files information

For JP1/AJS3 - Manager or JP1/AJS3 - Agent:

/var/opt/jp1ajs2/sys

For JP1/AJS3 - Web console:

/opt/jp1ajs3web/sys

/var/opt/jp1ajs3web/sys

4. Job information

For JP1/AJS3 - Manager:

/var/opt/jp1ajs2/jobinf

5. Environment-settings file information

For JP1/AJS3 - Manager or JP1/AJS3 - Agent:

/etc/opt/jp1ajs2/conf

For JP1/AJS3 - Web console:

/etc/opt/jp1ajs3web/conf

6. JP1/Base information

/var/opt/jp1base/log

```
/var/opt/jplbase/sys
/etc/opt/jplbase/conf
```

7. syslog and the directories containing syslog

In HP-UX:

```
/var/adm/syslog/syslog.log
```

In Solaris:

```
/var/adm/messages
```

In AIX:

```
/var/adm/syslog
```

In Linux:

```
/var/adm/messages*
```

8. /var/opt/jplajs2/database^{#3}

9. *embedded-database-practical-folder/conf*^{#3}

10. *embedded-database-practical-folder/spool*^{#3}

11. *embedded-database-practical-folder/etc*^{#3}

12. Detailed information about JP1/Base (This is information collected by using the JP1/Base data collection tool.)

See the estimation formula for the JP1/Base data collection tool in the applicable JP1/Base manual.

#2

This parameter is the total size of the following directories and files.

1. Information about the shared directory for JP1/AJS3 - Manager and JP1/AJS3 - Agent

```
shared-directory/jplajs2
```

2. Information about the shared directories of JP1/Base

```
shared-directory/jplbase/log
```

```
shared-directory/jplbase/conf
```

3. *embedded-database-practical-directory-on-logical-host/conf*^{#3}

4. *embedded-database-practical-directory-on-logical-host/spool*^{#3}

5. *embedded-database-practical-directory-on-logical-host/etc*^{#3}

#3

This information is collected for JP1/AJS3 - Manager only. You do not need to check the size of this information for the other products.

You can check the size of the embedded database practical directory by executing the following `ajsembdbidlist` command:

```
/opt/jplajs2/tools/ajsembdbidlist
```

When you actually use the data collection tool, make sure that the free space is a few gigabytes larger than the estimated size. The data collection tool uses free space as a work area.

After you have estimated the size of data that will be collected and confirmed that there is sufficient free disk space, perform a trial data collection. Verify that the estimation is correct by comparing the estimated size with the size of the trial collected data. If there is not sufficient free disk space, prepare a disk with sufficient free space, and execute the data collection tool by specifying the disk with the `-f` option on the command line. The next time you perform data collection, estimate the required free disk space based on the total size of the files that were collected on a trial basis.

Notes

- `_04` is the data collection tool for JP1/AJS3 10-10 or earlier. For JP1/AJS3 10-50 or later, you can use both `jaajs_log` and `_04`.
- For JP1/AJS3 - Web Console, you can use `jaajs_log` only. You cannot use `_04`, so you cannot customize the data collection tool.

Execution privileges

Superuser privilege

Storage directory

For `jaajs_log` for JP1/AJS3 - Manager and JP1/AJS3 - Agent:

```
/opt/jp1ajs2/tools
```

For `jaajs_log` for JP1/AJS3 - Web Console:

```
/opt/jp1ajs3web/tools
```

For `_04`

```
/opt/jp1ajs2/lib/sample_script
```

Arguments

-h *logical-host-name*

Specify the name of the target logical host.

The data collection tool collects the data on the physical host in addition to the data on the specified logical host.

If you do not specify a name, the data collection tool obtains the physical host logs.

-f *storage-directory*

Use a full path without space characters to specify the directory used to store the collected information. If the specified directory name contains a space character, the system assumes that the character string before the space is the storage directory name and treats the characters after the space as other arguments.

When you use a relative path to specify a storage directory, the specified path is created under the root directory and the collected data is stored there.

If you specify a directory that does not exist, a new directory with that name is created. If data has already been collected in the specified storage directory, a message asking whether you want to overwrite the data appears.

If you omit this option, the collected data is output to `/tmp/jp1ajs2/trouble/`.

-s

Specify this option if you do not want to collect information about the database used by JP1/AJS3.

If you do not specify this option, the data collection tool collects information about the database.

-t

Specify this option if you do not want to obtain the `hosts`, `services`, and `passwd` files.

-u

Specify this option if you do not want to obtain the core file.

Although you specify this option, the back trace information is collected.

-e

Specify this option if you do not want to collect detailed information about the embedded database.

The detailed information about the embedded database is the data for the second report, which is output to the `embdbinfo` directory.

If you do not specify this option, the data collection tool collects detailed information about the embedded database.

When this option is not specified, it is automatically determined whether to collect the information. Therefore, do not specify this option if you are unsure about whether detailed information about the embedded database needs to be collected.

Specify this option only when you want to suppress the collection of detailed information about the embedded database.

-b

Specify this option if you do not want to collect detailed information about JP1/Base.

The detailed information about JP1/Base is the data for the second report, which is output to the `JP1BASE_INFO` directory.

If you do not specify this option, the data collection tool collects detailed information about JP1/Base.

When this option is not specified, it is automatically determined whether to collect the information. Therefore, do not specify this option if you are unsure about whether detailed information about JP1/Base needs to be collected.

Specify this option only when you want to suppress the collection of detailed information about JP1/Base.

If free disk space at the output destination is insufficient, execute the data collection tool with the `-b` option specified, and then execute the data collection tool for JP1/Base (`jbs_log`) to collect detailed information about JP1/Base. For details about the data collection tool for JP1/Base (`jbs_log`), see the *JP1/Base User's Guide*.

additional-file

Use a full path without space characters to specify a file that is not usually obtained by using the data collection tool, such as the core file of the JP1/AJS3 commands. If the specified file name contains a space character, the system assumes that the character string before the space is an additional file name and treats the characters after the space as other arguments.

Using this argument, you can collect information that is not automatically collected by the data collection tool.

If the core file is specified as an additional file, the core file is collected even if you specify the `-u` option.

You can specify a directory name for *additional-file*. If you specify a directory, all the data in the specified directory is collected.

Notes

1. If you collect data about a logical host in a cluster system, you must mount the shared disk for the logical host.
2. The data collection tool compresses the collected data as follows for each OS.

In Linux:

The data collection tool uses the `gzip` command to compress the data. If the `gzip` command is not installed in the environment in which the data collection tool is executed, the data collection tool uses the `tar` command to compress and output the data; it does not use the `compress` command. If the `tar` command is not installed, the data collection tool terminates abnormally, and processing ends.

In UNIX other than Linux:

The data collection tool uses the `compress` command to compress the data. If the `compress` command is not installed in the environment in which the data collection tool is executed, the tool uses the `gzip` command instead. If neither the `compress` command nor the `gzip` command is available, the data collection tool uses the `tar` command to archive and output the data. If the `tar` command is not installed, the data collection tool terminates abnormally, and processing ends.

3. Because the user might not have reference permission for a file contained in the script, the superuser must execute the script.
4. If you have already created a file containing the results of executing the script, JP1/AJS3 outputs a message asking for permission to overwrite the file. Enter `y` to overwrite the file. If you do not want to overwrite the file, enter `n`.
5. If no core dump file is output, a message (`Status of tar: core? is unknown. The file is not dumped.`) appears. This is not a problem.
6. If the target product is not installed or is being used by another process, or a file that cannot be accessed because of its file attribute is detected, a message reporting that there is no applicable directory or file or that the target file cannot be accessed might appear during the collection of data. This is not a problem.
7. Because the `ajs2collectcore` command is executed internally while the data collection tool is being executed, some data cannot be collected, depending on the OS. For details, see [ajs2collectcore \(UNIX only\) in 3. Commands Used for Normal Operations](#).
8. If there is no data to be collected, a file containing the execution result of the data collection tool is not created.
9. Do not execute more than one data collection tool at the same time. Do not execute `jajs_log` and `_04` at the same time.
10. The data collection tool executed by an AJS administrator cannot collect information that requires superuser privileges. We recommend that a user with superuser privileges executes the data collection tool.
To execute the data collection tool, the following operations must be performed:
 - The output destination file must be deleted before the data collection tool is executed.
 - The JP1 administrator group must be granted write permissions for the output destination directory.
 - The JP1 administrator group must be granted access permissions for the root directory.
 - To add the additionally collected data, the JP1 administrator group must be granted access permissions.
11. When you specify options, do not specify characters or symbols that have special meanings in the script. If you specify such characters and symbols, an unexpected error might occur.
12. If the embedded database service has stopped, information about the database stored in the embedded database is not collected even if you execute the command without the `-s` option specified.
13. If an error occurred in the embedded database, information about the database stored in the embedded database might not be collectible.
14. If JP1/AJS3 is operated by using an external database, and the connected database has stopped, information about the connected database is not collected even if the command is executed with the `-s` option specified.
15. In cases where JP1/AJS3 is operated by using an external database, and an error occurs in the connected database, information about the connected database might not be collectible.

Return values

| | |
|--------------------|--------------|
| 0 | Normal end |
| Value other than 0 | Abnormal end |

Messages

| Message | Description | System action |
|--|--|----------------------------|
| Directory <i>directory-name</i> is created | A directory is created. | Continues processing. |
| Some data could not be collected by AJS Administrator. | Some data could not be collected because an AJS administrator executed the data collection tool. | Continues processing. |
| Overwrite file (<i>file-name</i>) ok? | This message asks you whether you want to overwrite <i>file-name</i> . Press y to continue the processing, or press n to cancel the processing. | Waits for a user response. |
| [CAUTION] When a target program is not installed, or when file access fails because some other process is using the file or because a necessary file-access permission is lacking, a message might be output that states that file access failed or a directory or file does not exist. Such a message does not indicate a problem. | This message is displayed when the specified file is being used or was not found during data collection. However, there is no problem. | Continues processing. |
| Output file name : (<i>file-name</i>) | The file indicated by <i>file-name</i> has been created. | Terminates the processing. |
| Write permission error (<i>directory-name</i>) | You do not have write permission. Possible reasons are as follows: <ul style="list-style-type: none"> You do not have permission to create a directory. The directory is being used by another process. Correct the error, and then re-execute the data collection tool. | Terminates the processing. |
| Make directory (<i>directory-name</i>) is unsuccessful | The directory could not be created. Possible reasons are as follows: <ul style="list-style-type: none"> You do not have permission to create a directory. The directory is being used by another process. Correct the error, and then re-execute the data collection tool. | Terminates the processing. |
| Read permission error (<i>file-name</i>) | You do not have read permission. Obtain read permission, and then re-execute the data collection tool. | Terminates the processing. |
| File <i>file-name</i> is not found | The directory or file specified as the additional file was not found. Specify a correct path, and then re-execute the data collection tool. | Terminates the processing. |
| [-s] [-f <i>output-file</i>] [-h <i>Logical-Host-Name</i>] [-t] [-u] [-e] [-b] [<i>add-in-file</i> ...] | The options are specified incorrectly. Specify the options correctly, and then re-execute the data collection tool. | Terminates the processing. |

| Message | Description | System action |
|---|---|-----------------------|
| The collection of detailed information on EmbedDB _JF*# begins. | Collection of detailed information about the embedded database has started. | Continues processing. |
| The collection of detailed information on EmbedDB _JF*# ended. | Collection of detailed information about the embedded database has ended. | Continues processing. |
| The collection of detailed information on JP1/Base begins. | Collection of detailed information about JP1/Base has started. | Continues processing. |
| The collection of detailed information on JP1/Base ended. | Collection of detailed information about JP1/Base has ended. | Continues processing. |
| The collection of the database information on SQLSVR begins. | If an external database is used, collection of information about the connected database starts. | Continues processing. |
| The collection of the database information on SQLSVR ends. | If an external database is used, collection of information about the connected database ends. | Continues processing. |

#

_JF* indicates an embedded database identifier (_JF0, _JF1, _JF2, and so on). Detailed information is collected for each identifier.

Example 1

The following command collects data about a physical host:

For `jajs_log`:

```
jajs_log
```

If you use `_04` customized to `trouble.sh`:

```
trouble.sh
```

Example 2

The following command collects data about a logical host (`cluster`):

For `jajs_log`:

```
jajs_log -h cluster
```

If you use `_04` customized to `trouble.sh`:

```
trouble.sh -h cluster
```

Example 3

The following command outputs information, including the core file (`/tmp/core`), to a specified file (`/tmp/trouble`):

For `jajs_log`:

```
jajs_log -f /tmp/trouble /tmp/core
```

If you use `_04` customized to `trouble.sh`:

```
trouble.sh -f /tmp/trouble /tmp/core
```

Data that can be collected

For physical hosts:

- The data for first reports (`/tmp/jplajs2/trouble/JP1_DEFAULT_1st.tar.z#1`)

| Name of directory or file containing collected data | Description |
|--|---|
| <code>/etc/hosts</code> | hosts file |
| <code>/etc/passwd</code> | passwd file |
| <code>/etc/services</code> | services file |
| <code>/etc/.hitachi</code> | Information about installed Hitachi products |
| <ol style="list-style-type: none"> <code>/etc/opt/jplajs2/conf</code> <code>/etc/opt/jplbase/conf</code> <code>/tmp/jplajs2/trouble#1/JP1AJS3WEB_INFO/etc/opt/jplajs3web/conf</code> | Directories containing the environment settings files |
| <code>/etc/opt/.hlic/</code> | License registration information |
| <code>/opt/jp1/hcclibcnf/regdir</code> | Common definition |
| <ol style="list-style-type: none"> <code>/opt/jplajs2/PatchHistory</code> <code>/opt/jplajs2/PatchLog</code> <code>/opt/jplajs2v/PatchHistory</code> <code>/opt/jplajs2v/PatchLog</code> <code>/tmp/jplajs2/trouble#1/JP1AJS3WEB_INFO/PatchLog</code> | Patch information |
| <ol style="list-style-type: none"> <code>/var/adm/syslog/syslog.log</code> (for HP-UX) <code>/var/adm/messages</code> (for Solaris) <code>/var/adm/syslog</code> (for AIX) <code>/var/adm/messages*</code> (for Linux) | syslog and the directories containing syslog |
| <ol style="list-style-type: none"> <code>/opt/hitachi/HNTRLlib/spool</code> <code>/var/opt/hitachi/HNTRLlib2/spool</code> | Integrated trace logs |
| <code>/var/opt/hitachi/jp1common</code> | HLICLIB log |
| <ol style="list-style-type: none"> <code>/var/opt/jplajs2/log</code> <code>/tmp/jplajs2/trouble#1/JP1AJS3WEB_INFO/var/opt/jplajs3web/log</code> | Directory containing log files |
| <ol style="list-style-type: none"> <code>/var/opt/jplajs2/log/_04.filelist</code> <code>/tmp/jplajs2/trouble#1/JP1AJS3WEB_INFO/_webras.filelist</code> | List of files |
| <code>/var/opt/jplajs2/log/_04.osinfo</code> | OS-related information |
| <code>/var/opt/jplajs2/log/_04.processlist</code> | List of processes |
| <code>/var/opt/jplajs2/log/_04.backtrace</code> | Back trace information |
| <code>/var/opt/jplajs2/log/ajsagtshow.txt</code> | Execution result of the <code>ajsagtshow</code> command |

| Name of directory or file containing collected data | Description |
|---|---|
| /var/opt/jplajs2/log/ajsagtshow_e.txt | Execution result of the <code>ajsagtshow</code> command (<code>-e</code> option) |
| /var/opt/jplajs2/log/ajsagtprint.txt | Execution result of the <code>ajsagtprint</code> command |
| /var/opt/jplajs2/log/jajs_status.txt | Execution result of the <code>jajs_status</code> command |
| /var/opt/jplajs2/log/jajsadminusr_{1 2}.log | Setting and reference log for AJS administrators |
| /var/opt/jplajs2/log/ajsprof_scheduler-service-name_agent_stat.txt#2 | Execution result of the <code>ajsprofstatus</code> (<code>-t agent -s</code> option) |
| /var/opt/jplajs2/log/ajsprof_scheduler-service-name_agent_def.txt#2 | Execution result of the <code>ajsprofstatus</code> (<code>-t agent -p</code> option) |
| /var/opt/jplajs2/log/ajsprof_scheduler-service-name_unit_stat.txt#2 | Execution result of the <code>ajsprofstatus</code> (<code>-t unit -s</code> option) |
| /var/opt/jplajs2/log/ajsprof_scheduler-service-name_unit_def.txt#2 | Execution result of the <code>ajsprofstatus</code> (<code>-t unit -p</code> option) |
| /var/opt/jplajs2/log/jajs_pmtcon_m.txt | Execution result of the <code>jajs_pmtcon</code> (<code>-m -v</code> option) |
| /var/opt/jplajs2/log/jajs_pmtcon_a.txt | Execution result of the <code>jajs_pmtcon</code> (<code>-a -v</code> option) |
| 1. /var/opt/jplajs2/sys 2. /tmp/jplajs2/trouble#1/ JP1AJS3WEB_INFO/var/opt/jplajs3web/sys 3. /tmp/jplajs2/trouble#1/JP1AJS3WEB_INFO/opt/ jplajs3web/sys | Directory containing the system files |
| /tmp/jplajs2/trouble#1/ JP1AJS3WEB_INFO/var/opt/jplajs3web/tmp | Directory containing the work files |
| /var/opt/jplajs2/tmp/schedule/pd*.trc | Trace information related to the embedded database |
| 1. /var/opt/jplajs2v/log 2. /var/opt/jplbase/log | Directories containing log files |
| /tmp/jplajs2/trouble#1/EMBDB/_JF*#3/conf | Embedded database definition file |
| /tmp/jplajs2/trouble#1/EMBDB/_JF*#3/spool | Embedded database failure investigation file |
| /tmp/jplajs2/trouble#1/EMBDB/_JF*#3/etc | Other information related to the embedded database that is needed for investigation |
| 1. /var/opt/jplajs2/embsch 2. /opt/jplajs2/embsch/ga.ini 3. /opt/jplajs2/embsch/Readme.txt | Directory and files used for a flexible job |
| 1. /tmp/jplajs2/trouble#1/ JP1AJS3WEB_INFO/snapshotlog.txt 2. /tmp/jplajs2/trouble#1/JP1AJS3WEB_INFO/ srvdata/snapshot.zip | Web server information |
| /tmp/jplajs2/trouble#1/JP1AJS3WEB_INFO/SHARED | Shared directory of web server |

#1

Output destination when the `-f` option is omitted.

#2

Information about all scheduler services on the host is collected.

#3

`_JF*` indicates an embedded database identifier (`_JF0`, `_JF1`, `_JF2`, and so on). A directory is created for each identifier.

- The data for second reports (`/tmp/jplajs2/trouble/JP1_DEFAULT_2nd.tar.z#1`)

| Name of directory or file containing collected data | Description |
|--|--|
| 1. <code>/tmp/jplajs2/trouble#1/CARDIR/coreinfo-ISAM.shmdump.tar.z#2</code> 2. <code>/tmp/jplajs2/trouble#1/CARDIR/coreinfo-Scheduler.shmdump.tar.z#2</code> 3. <code>/tmp/jplajs2/trouble#1/CARDIR/../../core.z#2</code> 4. <code>/tmp/jplajs2/trouble#1/CARDIR/../../coreinfo-analyze.tar.z#2</code> 5. <code>/tmp/jplajs2/trouble#1/CARDIR/ProgMon.shmdump</code> 6. <code>/tmp/jplajs2/trouble#1/CARDIR/coreinfo-host.shmdump</code> 7. <code>/tmp/jplajs2/trouble#1/CARDIR/coreinfo-hostprof.shmdump</code> 8. <code>/tmp/jplajs2/trouble#1/CARDIR/coreinfo-pmtcon_m.shmdump</code> 9. <code>/tmp/jplajs2/trouble#1/CARDIR/coreinfo-pmtcon_a.shmdump</code> | Shared memory information used by ISAM and the scheduler, core dump files, shared library information, operation profile information, and information about the shared memory for the connection source restriction function |
| 1. <code>/var/opt/jplajs2/database</code> 2. <code>/tmp/jplajs2/trouble#1/embdatabse/_JF*#3</code> 3. <code>/tmp/jplajs2/trouble#1/extdb/SQLSVR/scheduler-service-name#6</code> | Database storage directories |
| <code>/tmp/jplajs2/trouble#1/embdbinfo/_JF*#3</code> | Detailed information about the embedded database |
| <code>/tmp/jplajs2/trouble#1/JP1BASE_INFO#5</code> | Detailed information about JP1/Base |
| <code>/additionally-collected-data#4</code> | Additionally collected data |

#1

Output destination when the `-f` option is omitted.

#2

This file is output to the directory containing the core dump file that has been obtained.

#3

`_JF*` indicates an embedded database identifier (`_JF0`, `_JF1`, `_JF2`, and so on). A directory is created for each identifier.

#4

This file is created when *additional-file* is specified as the argument.

#5

The detailed information about JP1/Base is created as data for the second physical hosts report, regardless of the data for physical hosts or logical hosts.

#6

If an external database is used, a directory is created for each scheduler service.

- The data for third reports (`/tmp/jplajs2/trouble/JP1_DEFAULT_3rd.tar.z#`)

| Name of directory or file containing collected data | Description |
|---|---|
| <code>/var/opt/jplajs2/jobinf</code> | Directory containing information about jobs |

#

Output destination when the `-f` option is omitted

For logical hosts:

- The data for first reports (`/tmp/jplajs2/trouble/logical-host-name_1st.tar.z#1`)

| Name of directory or file containing collected data | Description |
|---|---|
| <code>/shared-directory-name/jplajs2/backup</code> | Directory containing backup files |
| <code>/shared-directory-name/jplajs2/conf</code> | Directory containing environment settings files |
| <code>/shared-directory-name/jplajs2/log</code> | Directory containing log files |
| <code>/shared-directory-name/jplajs2/sys</code> | Directory containing the system files |
| <code>/shared-directory-name/jplajs2/tmp</code> | Directory containing work files |
| <code>/shared-directory-name/jplbase/conf</code> | Directory containing the environment settings files |
| <code>/shared-directory-name/jplbase/log</code> | Directory containing log files |
| <code>/shared-directory-name/jplajs2/log/ajsagtshow.txt</code> | Execution result of the <code>ajsagtshow</code> command |
| <code>/shared-directory-name/ jplajs2/log/ajsagtshow_e.txt</code> | Execution result of the <code>ajsagtshow</code> command (<code>-e</code> option) |
| <code>/shared-directory-name/ jplajs2/log/ajsagtprint.txt</code> | Execution result of the <code>ajsagtprint</code> command |
| <code>/shared-directory-name/ jplajs2/log/jajs_status.txt</code> | Execution result of the <code>jajs_status</code> command |
| <code>/shared-directory-name/ jplajs2/log/ajsprof_scheduler-service- name_agent_stat.txt#2</code> | Execution result of the <code>ajsprofstatus</code> command (<code>-t agent -s</code> option) |
| <code>/shared-directory-name/ jplajs2/log/ajsprof_scheduler-service- name_agent_def.txt#2</code> | Execution result of the <code>ajsprofstatus</code> command (<code>-t agent -p</code> option) |
| <code>/shared-directory-name/ jplajs2/log/ajsprof_scheduler-service- name_unit_stat.txt#2</code> | Execution result of the <code>ajsprofstatus</code> command (<code>-t unit -s</code> option) |
| <code>/shared-directory-name/ jplajs2/log/ajsprof_scheduler-service- name_unit_def.txt#2</code> | Execution result of the <code>ajsprofstatus</code> command (<code>-t unit -p</code> option) |
| <code>/shared-directory-name/ jplajs2/log/jajs_pmtcon_m.txt</code> | Execution result of the <code>jajs_pmtcon</code> (<code>-m -v</code> option) |
| <code>/shared-directory-name/ jplajs2/log/jajs_pmtcon_a.txt</code> | Execution result of the <code>jajs_pmtcon</code> (<code>-a -v</code> option) |
| <code>/tmp/jplajs2/trouble#1/EMBDB_logical-host-name/ _JF*#3/conf</code> | Embedded database definition file |
| <code>/tmp/jplajs2/trouble#1/EMBDB_logical-host-name/ _JF*#3/spool</code> | Embedded database failure investigation file |
| <code>/tmp/jplajs2/trouble#1/EMBDB_logical-host-name/ _JF*#3/etc</code> | Other information related to the embedded database that is needed for investigation |

#1

Output destination when the `-f` option is omitted.

#2

Information about all scheduler services on the host is collected.

#3

`_JF*` indicates an embedded database identifier (`_JF0`, `_JF1`, `_JF2`, and so on). A directory is created for each identifier.

- The data for second reports (`/tmp/jplajs2/trouble/logical-host-name_2nd.tar.Z#1`)

| Name of directory or file containing collected data | Description |
|--|--|
| 1. <code>/tmp/jplajs2/trouble^{#1}/CARDIR_logical-host-name/ProgMon.shmdump</code> 2. <code>/tmp/jplajs2/trouble^{#1}/CARDIR_logical-host-name/coreinfo-host.shmdump</code> | Shared memory dumps |
| 1. <code>/shared-directory-name/jplajs2/database</code> 2. <code>/tmp/jplajs2/trouble^{#1}/embdatabase_logical-host-name/_JF*^{#2}</code> | Database storage directories |
| <code>/tmp/jplajs2/trouble^{#1}/embdbinfo_logical-host-name/_JF*^{#2}</code> | Detailed information about embedded database |

#1

Output destination when the `-f` option is omitted.

#2

`_JF*` indicates an embedded database identifier (`_JF0`, `_JF1`, `_JF2`, and so on). A directory is created for each identifier.

- The data for third reports (`/tmp/jplajs2/trouble/logical-host-name_3rd.tar.Z#`)

| Name of directory or file containing collected data | Description |
|---|---|
| <code>/shared-directory-name/jplajs2/jobinf</code> | Directory containing information about jobs |

#

Output destination when the `-f` option is omitted

jajs_log.bat or _04.bat (Windows only)

Format

```
jajs_log.bat | _04.bat
  [-h logical-host-name]
  [-f storage-directory]
  [-s]
  [-t]
  [-u]
  [-e]
  [-b]
```

Description

The data collection tool obtains maintenance information, such as the JP1/AJS3 logs and information about the OS.

Both data collection tools have the same basic functionality. Use either tool depending on the purpose of use and whether customization is required.

The following table describes the purpose of `jajs_log.bat` and `_04.bat`, and whether they can be customized.

Table 3–28: Purpose of data collection tools and whether they can be customized

| Data collection tool | Purpose | Customization |
|---------------------------|---|---------------|
| <code>jajs_log.bat</code> | Use this tool if the log output destinations have not been changed from the defaults, or if you need to collect data by default only. | N |
| <code>_04.bat</code> | Customize this tool before using it if you have changed log output destinations from the defaults, or if you need to collect data other than the default data. ^{#1,#2} | Y |

Legend:

Y: The tool can be customized.

N: The tool cannot be customized.

#1

For details about the customization method, see *7.1.1 Setting up the data collection tools* in the *JP1/Automatic Job Management System 3 Configuration Guide*.

#2

If you have changed the installation destination folder from the default, use `jajs_log.bat` unless output destinations for log files were changed after installation.

By default, the results of executing the data collection tool are output to the following folders under `%TEMP%\jplajs2\backlog`.

For physical hosts:

1. `JP1_DEFAULT\JP1_DEFAULT_1st`
The data for the first reports is output.
2. `JP1_DEFAULT\JP1_DEFAULT_2nd`
The data for the second reports is output.
3. `JP1_DEFAULT\JP1_DEFAULT_3rd`
All other data is output.

For logical hosts:

1. *logical-host-name\logical-host-name_1st*
The data for the first reports is output.
2. *logical-host-name\logical-host-name_2nd*
The data for the second reports is output.
3. *logical-host-name\logical-host-name_3rd*
All other data is output.

Estimation of the size of information collected by the data collection tool

The following shows the formula for estimating the size of information that the data collection tool will collect when it is executed with the option to collect all information. Note that the estimation formula requires you to sum the sizes of folders and files. The summation method is explained later.

- When collecting data for a physical host

```
size-of-data-in-physical-host-environment#1 x 3
```

- When collecting data for a logical host

```
(size-of-data-in-physical-host-environment#1 + size-of-data-in-logical-host-environment#2) x 3
```

#1

This parameter is the total size of the following folders and files. If multiple products installed in the same environment have the following folders and files, obtain the total size of the folders and files for all of those products.

1. Integrated trace logs information

```
%SystemDrive%\Program Files\Hitachi\HNTRLib2\spool  
%SystemDrive%\Program Files (x86)\Hitachi\HNTRLib2\spool
```

2. Log files information

For JP1/AJS3 - Manager or JP1/AJS3 - Agent:

```
JP1/AJS3 - Manager-or-JP1/AJS3 - Agent-installation-folder\log  
%ALLUSERSPROFILE%\HITACHI\JP1\JP1_DEFAULT\JP1AJS2\log
```

For JP1/AJS3 - View:

```
%ALLUSERSPROFILE%\HITACHI\JP1\JP1_DEFAULT\JP1AJS2V\log
```

For JP1/AJS3 - Definition Assistant:

```
%ALLUSERSPROFILE%\HITACHI\JP1\JP1_DEFAULT\JP1AJS2DA\log
```

For JP1/AJS3 - Web console:

```
%ALLUSERSPROFILE%\HITACHI\JP1\JP1_DEFAULT\JP1AJS3WEB\log
```

3. System files information

For JP1/AJS3 - Manager or JP1/AJS3 - Agent:

```
%ALLUSERSPROFILE%\HITACHI\JP1\JP1_DEFAULT\JP1AJS2\sys
```

For JP1/AJS3 - View:

```
JP1/AJS3 - View-installation-folder\sys
```

For JP1/AJS3 - Web console:

```
JP1/AJS3 - Web-Console-installation-folder\sys  
%ALLUSERSPROFILE%\HITACHI\JP1\JP1_DEFAULT\JP1AJS3WEB\sys
```

4. Job information

For JP1/AJS3 - Manager:

`%ALLUSERSPROFILE%\HITACHI\JP1\JP1_DEFAULT\JP1AJS2\jobinf`

5. Environment-settings file information

For JP1/AJS3 - Manager or JP1/AJS3 - Agent:

`JP1/AJS3 - Manager-or-JP1/AJS3 - Agent-installation-folder\conf`

`%ALLUSERSPROFILE%\HITACHI\JP1\JP1_DEFAULT\JP1AJS2\conf`

For JP1/AJS3 - View:

`JP1/AJS3 - View-installation-folder\conf`

`%ALLUSERSPROFILE%\HITACHI\JP1\JP1_DEFAULT\JP1AJS2V\conf`

For JP1/AJS3 - Definition Assistant:

`JP1/AJS3-Definition-Assistant-installation-folder\conf`

For JP1/AJS3 - Web console:

`JP1/AJS3 - Web-Console-installation-folder\conf`

6. JP1/Base information

`JP1/Base-installation-folder\log`

`JP1/Base-installation-folder\sys`

`JP1/Base-installation-folder\conf`

`%ALLUSERSPROFILE%\HITACHI\JP1\JP1_DEFAULT\JP1Base\log`

7. Event logs (application log and system log)

These logs are saved in two file formats: event file and text file. Sum the sizes of these files for all event logs.

8. `%ALLUSERSPROFILE%\HITACHI\JP1\JP1_DEFAULT\JP1AJS2\database#3`

9. `embedded-database-practical-folder\conf#3`

10. `embedded-database-practical-folder\spool#3`

11. `embedded-database-practical-folder\UXPLDIR#3`

12. Detailed information about JP1/Base (This is information collected by using the JP1/Base data collection tool.)

See the estimation formula for the JP1/Base data collection tool in the applicable JP1/Base manual.

#2

This parameter is the total size of the following folders and files.

1. Information about the shared folder for JP1/AJS3 - Manager and JP1/AJS3 - Agent

`shared-directory\jplajs2`

2. Information about the shared folders of JP1/Base

`shared-directory\jplbase\log`

`shared-directory\jplbase\conf`

3. `embedded-database-practical-directory-on-logical-host\conf#3`

4. `embedded-database-practical-directory-on-logical-host\spool#3`

5. `embedded-database-practical-directory-on-logical-host\UXPLDIR#3`

#3

This information is collected for JP1/AJS3 - Manager only. You do not need to check the size of this information for the other products.

You can check the size of the embedded database practical directory by executing the following `ajsembdbidlist` command:

```
JP1/AJS3-installation-folder\tools\ajsembdbidlist
```

When you actually use the data collection tool, make sure that the free space is a few gigabytes larger than the estimated size. The data collection tool uses free space as a work area.

After you have estimated the size of data that will be collected and confirmed that there is sufficient free disk space, perform a trial data collection. Verify that the estimation is correct by comparing the estimated size with the size of the trial collected data. If there is not sufficient free disk space, prepare a disk with sufficient free space, and execute the data collection tool by specifying the disk with the `-f` option on the command line. The next time you perform data collection, estimate the required free disk space based on the total size of the files that were collected on a trial basis.

Notes

- `_04.bat` is the data collection tool for JP1/AJS3 10-10 and earlier. For JP1/AJS3 10-50 and later, you can use both `jajs_log.bat` and `_04.bat`.
- For JP1/AJS3 - Web Console, you can use `jajs_log.bat` only. You cannot use `_04.bat`, so you cannot customize the data collection tool.

Execution privileges

Administrators privileges

Storage directory

For `jajs_log.bat`:

```
JP1/AJS3-installation-folder\tools
```

For `_04.bat`:

```
JP1/AJS3-installation-folder\tools
```

Arguments

-h *logical-host-name*

Specify the name of the target logical host.

The data collection tool collects the data on the physical host in addition to the data on the specified logical host.

If you do not specify a name, the data collection tool obtains the physical host logs.

-f *storage-directory*

Use the absolute path to the folder to which collected data is output. You can also use a relative path from the location in which the command is executed. However, you cannot specify the root directory.

To specify a path that contains spaces, enclose the entire path in double quotation marks ("").

If you specify a folder that does not exist, a new folder with that name is created.

If data has already been collected under the specified storage folder, a message asking whether you want to overwrite the files appears.

If you specify too long a path to the storage folder, data collection might fail. If data collection fails, specify a shorter path, and then retry collecting data.

If you omit this option, the collected data is output to %TEMP%\jplajs2\backlog. If you specify this option, the value of this option overrides the storage folder that was changed from the default by customizing the tool.

-s

Specify this option if you do not want to collect information about the database used by JP1/AJS3.

If you do not specify this option, the data collection tool collects information about these databases.

-t

Specify this option if you do not want to obtain the `hosts` and `services` files.

-u

Specify this option if you do not want to obtain dump files.

-e

Specify this option if you do not want to collect detailed information about the embedded database.

The detailed information about the embedded database is the data for the second report, which is output to the `embdbinfo` folder.

If you do not specify this option, the data collection tool collects detailed information about the embedded database.

When this option is not specified, it is automatically determined whether to collect the information. Therefore, do not specify this option if you are unsure about whether detailed information about the embedded database needs to be collected.

Specify this option only when you want to suppress the collection of detailed information about the embedded database.

-b

Specify this option if you do not want to collect detailed information about JP1/Base.

The detailed information about JP1/Base is the data for the second report, which is output to the `JP1BASE_INFO` folder.

If you do not specify this option, the data collection tool collects detailed information about JP1/Base.

When this option is not specified, it is automatically determined whether to collect the information. Therefore, do not specify this option if you are unsure about whether detailed information about JP1/Base needs to be collected.

Specify this option only when you want to suppress the collection of detailed information about JP1/Base.

If free disk space at the output destination is insufficient, execute the data collection tool with the `-b` option specified, and then execute the data collection tool for JP1/Base (`jbs_log`) to collect detailed information about JP1/Base. For details about the data collection tool for JP1/Base (`jbs_log`), see the *JP1/Base User's Guide*.

Notes

1. If you execute the data collection tool without the `-s` option specified during startup of the JP1/AJS3 service, the job might end abnormally. In such a case, JP1/AJS3 does not collect information about the ISAM database.
2. To collect data about a logical host in a cluster system, execute the data collection tool on the host on which the logical host runs.
3. The data collection tool does not compress the data if collects. To compress the data, use a data compression tool.
4. If you have already created a file containing the execution results of batch files, JP1/AJS3 outputs a message asking for permission to overwrite the file. To overwrite the file, specify `y`. If you do not want to overwrite the file, specify `n`.
5. While a batch file is being executed, JP1/AJS3 might display an error message reporting that a sharing violation has occurred for a file in the *JP1/AJS3 - Manager-or-JP1/AJS3 - Agent-installation-folder*\sys folder. This is not a problem.
6. If you perform an operation on the collected data such as, moving it or deleting it immediately after the execution of the data collection tool has finished, a message reporting that the process cannot access a file because another process is currently using the file might appear. This message appears because a process that collects OS information internally is still being executed despite termination of the tool. If this message appears, wait a while and then retry the operation.
7. If you execute the data collection tool while using Outlook, the following message might appear:

```
The program is attempting to access email addresses in Outlook. Is this all right?
```

The program indicated in this message is the machine configuration collection program (`msinfo32`) executed internally by the data collection tool. This program does not affect the operation of the data collection tool or Outlook. The data collection tool does not collect email addresses. If this message appears, click the **No** button.

8. When you execute the data collection tool, you must open the Command Prompt window as an administrator. If you are not an administrator, UAC will frequently open a confirmation dialog box. If you turn UAC off, you will not need to open the Command Prompt window as an administrator.
9. Do not execute more than one data collection tool at the same time. Do not execute `jajs_log.bat` and `_04.bat` at the same time.
10. When you specify options, do not specify characters or symbols that have special meanings in the bat file. If you specify such characters and symbols, an unexpected error might occur.
11. If the embedded database service has stopped, information about the database stored in the embedded database is not collected even if you execute the command without the `-s` option specified.
12. If an error occurred in the embedded database, information about the database stored in the embedded database might not be collectible.
13. If JP1/AJS3 is operated by using an external database, and the connected database has stopped, information about the connected database is not collected even if the command is executed with the `-s` option specified.
14. In cases where JP1/AJS3 is operated by using an external database, and an error occurs in the connected database, information about the connected database might not be collectible.

Return values

| | |
|--------------------|--------------|
| 0 | Normal end |
| Value other than 0 | Abnormal end |

Messages

| Message | Description | Action |
|--|---|--|
| Finished. Press any key. | The process ended normally. Press any key. | Wait for a user response. |
| Failed. Press any key. | The process did not end normally. Press any key. See the output OS messages, remove the cause of the error, and then re-execute the process. | Wait for a user response. |
| File <i>file-name</i> is exist. Delete to continue? (y/n) | A file created the last time this process was executed exists. Press <i>y</i> to delete the file and continue processing, or press <i>n</i> to stop processing. | Wait for a user response. |
| Directory <i>directory-name</i> is exist. Delete to continue? (y/n) | A directory created the last time this process was executed exists. Press <i>y</i> to delete the directory and continue processing, or press <i>n</i> to stop processing. | Wait for a user response. |
| Error exist in option. | An option is specified incorrectly. Specify the option correctly, and then re-execute the process. | Complete the process. |
| The following logical hosts exist, other than the specified logical host. : <i>logical-host-name</i> | A logical host environment other than the one specified for the <i>-h</i> option exists. If necessary, re-execute the process. | After this message, the following message is output: Finished. Press any key. |
| The collection of detailed information on EmbedDB <i>_JF*#</i> begins. | Collection of detailed information about the embedded database has started. | Continue processing. |
| The collection of detailed information on EmbedDB <i>_JF*#</i> ended. | Collection of detailed information about the embedded database has ended. | Continue processing. |
| The collection of detailed information on JP1/Base begins. | Collection of detailed information about JP1/Base has started. | Continue processing. |
| The collection of detailed information on JP1/Base ended. | Collection of detailed information about JP1/Base has ended. | Continue processing. |
| The collection of Event Log in text format begins. | Collection of event log data in text format has started. | Continue processing. |
| The collection of Event Log in text format ended. | Collection of event log data in text format has ended. | Continue processing. |
| The collection of the database information on SQLSVR begins. | If an external database is used, collection of information about the connected database starts. | Continue processing. |
| The collection of the database information on SQLSVR ends. | If an external database is used, collection of information about the connected database ends. | Continue processing. |

#

*_JF** indicates an embedded database identifier (*_JF0*, *_JF1*, *_JF2*, and so on). Detailed information is collected for each identifier.

Example 1

The following command collects physical host materials:

For jajs_log:

```
jajs_log.bat
```

If you use _04 customized to trouble.bat:

```
trouble.bat
```

Example 2

The following command collects physical host materials when the JP1/AJS3 service is running:

For jajs_log:

```
jajs_log.bat -s
```

If you use _04 customized to trouble.bat:

```
trouble.bat -s
```

Example 3

The following command collects data about a logical host (cluster):

For jajs_log:

```
jajs_log.bat -h cluster
```

If you use _04 customized to trouble.bat:

```
trouble.bat -h cluster
```

Data that can be collected

For physical hosts:

- The data for first reports (%TEMP%\jplajs2\backlog\JP1_DEFAULT\JP1_DEFAULT_1st)

| Name of folder or file containing collected data | Description |
|--|--|
| 1. \FILELIST.txt 2. \JP1AJS3WEB_INFO\FILELIST.txt | List of files under the JP1/AJS3 installation folder |
| 1. \GETERROR.log 2. \JP1AJS3WEB_INFO\GETERROR.log | Log information that is output by the data collection tool (_04.bat) |
| \HOSTS | hosts file |
| \services | services file |
| 1. \JP1AJS2.DAT 2. \JP1AJS2C.DAT 3. \JP1AJS2DA.DAT 4. \JP1AJS2SE.DAT 5. \JP1AJS2V.DAT 6. \JP1AJS2WOA.DAT 7. \JP1AJS3WEB_INFO\JP1AJS3WEB.DAT 8. \JP1BASE.DAT | Registry information about each product |

| Name of folder or file containing collected data | Description |
|---|--|
| \REGDATA.DAT | JP1 registry information |
| \WIN.DAT | Windows registry information |
| \ajsqlstatus.txt | Execution result of ajsqlstatus.exe |
| \ajsagtshow.txt | Execution result of ajsagtshow.exe |
| \ajsagtshow_e.txt | Execution result of ajsagtshow.exe (-e option) |
| \ajsagtprint.txt | Execution result of ajsagtprint.exe |
| \jajs_status.txt | Execution result of jajs_status.exe |
| \ajsprof_scheduler-service-name_agent_stat.txt#1 | Execution result of ajsprofstatus.exe (-t agent -s option) |
| \ajsprof_scheduler-service-name_agent_def.txt#1 | Execution result of ajsprofstatus.exe (-t agent -p option) |
| \ajsprof_scheduler-service-name_unit_stat.txt#1 | Execution result of ajsprofstatus.exe (-t unit -s option) |
| \ajsprof_scheduler-service-name_unit_def.txt#1 | Execution result of ajsprofstatus.exe (-t unit -p option) |
| \jajs_pmtcon_m.txt | Execution result of jajs_pmtcon.exe (-m -v option) |
| \jajs_pmtcon_a.txt | Execution result of jajs_pmtcon.exe (-a -v option) |
| \OSINFO.txt | OS version, Windows environment variables, IP configuration, network configuration, statistics |
| 1. \PERMISSIONINFO.TXT 2. \JP1AJS3WEB_INFO\PERMISSIONINFO.TXT | Access permissions for JP1/AJS3 folders |
| \WINMSD.TXT | All system information that is collected by using the msinfo32 command |
| 1. \ALLUSERSPROFILE\conf\JP1AJS2 2. \conf\JP1AJS2DA 3. \ALLUSERSPROFILE\conf\JP1AJS2V 4. \conf\JP1AJS2WOA 5. \JP1AJS3WEB_INFO\ALLUSERPROFILE\conf | Environment-settings file storage folder |
| \EMDB_JF*#2\conf | Embedded database definition file |
| \EMDB_JF*#2\spool | Embedded database failure investigation file |

| Name of folder or file containing collected data | Description |
|--|---|
| \EMDB_JF*#2\etc | Other information related to the embedded database that is needed for investigation |
| 1. \HNTRLib2\spool 2. \JP1AJS3WEB_INFO\HNTRLib2 | Integrated trace log |
| 1. \ALLUSERSPROFILE\JP1AJS2 2. \JP1AJS2C 3. \ALLUSERSPROFILE\JP1AJS2DA 4. \JP1AJS2HC 5. \ALLUSERSPROFILE\JP1AJS2V 6. \JP1BASE 7. \JP1AJS3WEB_INFO\ALLUSERSPROFILE\log 8. \JP1AJS3WEB_INFO\jplcommon_ajs3web | Folders containing log files |
| 1. \PATCHLOG\JP1AJAJS2\PATCHLOG.txt 2. \PATCHLOG\JP1AJAJS2C\PATCHLOG.txt 3. \PATCHLOG\JP1AJAJS2DA\PATCHLOG.txt 4. \PATCHLOG\JP1AJAJS2V\PATCHLOG.txt 5. \PATCHLOG\JP1AJAJS2WOA\PATCHLOG.txt 6. \JP1AJS3WEB_INFO\PATCHLOG.txt | Patch log files |
| \resource\JP1AJS2V | Folder containing resource files |
| 1. \ALLUSERSPROFILE\sys\JP1AJS2 2. \sys\JP1AJS2WOA 3. \ALLUSERSPROFILE\sys\JP1AJS2V 4. \JP1AJS3WEB_INFO\sys | Folders containing the system files |
| \ALLUSERSPROFILE\tmp\JP1AJS2DA | Folders containing temporary files for execution |
| \JP1AJS3WEB_INFO\ALLUSERPROFILE\tmp | Folders containing the work files |
| \ALLUSERSPROFILE\tmp\schedule\pd*.trc | Embedded database trace logs |
| \user_acl | Folder containing user mapping and authentication settings files |
| 1. \jplcommon_ajs2 2. \jplcommon_ajs2da 3. \JP1AJS3WEB_INFO\jplcommon_ajs2 | Folder containing product information files |
| \HCDINST | Hitachi integrated installation log |
| \jplcommon | JP1/Base installation log |
| 1. \Version\JP1AJS2 2. \Version\JP1AJS2V 3. \Version\JP1AJS2DA 4. \JP1AJS3WEB_INFO\Version | Folders containing the version information files |
| 1. \embsch_data 2. \embsch_inst\ga.ini 3. \embsch_inst\Readme.txt | Folder used for a flexible job to store files, and files used for a flexible job |
| 1. \JP1AJS3WEB_INFO\snapshotlog.txt 2. \JP1AJS3WEB_INFO\srvdata\snapshot.zip | Web server information |

| Name of folder or file containing collected data | Description |
|--|-----------------------------|
| \JP1AJS3WEB_INFO\SHARED | Shared folder of web server |

#1

Information about all scheduler services on the host is collected.

#2

_JF* indicates an embedded database identifier (_JF0, _JF1, _JF2, and so on). A folder is created for each identifier.

- The data for second reports (%TEMP%\jplajs2\backlog\JP1_DEFAULT\JP1_DEFAULT_2nd)

| Name of folder or file containing collected data | Description |
|--|--|
| \ADD | Folder for additional collected data |
| 1. \cmdatabase 2. \database 3. \embdatabase_JF*#1 4. \extdb\SQLSVR\scheduler-service-name#3 | Database storage folders |
| 1. \eventlog\AppEvent (Backup) .evt 2. \eventlog\AppEvent (Backup) .txt | Application event log |
| 1. \eventlog\SysEvent (Backup) .evt 2. \eventlog\SysEvent (Backup) .txt | System event log |
| 1. \SHMDUMP\coreinfo-ISAM.shmdump 2. \SHMDUMP\coreinfo-Scheduler.shmdump 3. \SHMDUMP\ProgMon.shmdump 4. \SHMDUMP\coreinfo-host.shmdump 5. \SHMDUMP\coreinfo-hostprof.shmdump 6. \SHMDUMP\coreinfo-pmtcon_m.shmdump 7. \SHMDUMP\coreinfo-pmtcon_a.shmdump | Shared memory information |
| \USERDUMP* .dmp | Dump files |
| \embdbinfo_JF*#1 | Detailed information about the embedded database |
| \JP1BASE_INFO#2 | Detailed information about JP1/Base |

#1

_JF* indicates an embedded database identifier (_JF0, _JF1, _JF2, and so on). A folder is created for each identifier.

#2

The detailed information about JP1/Base is created as data for the second physical hosts report, regardless of the data for physical hosts or logical hosts.

#3

If an external database is used, a directory is created for each scheduler service.

- The data for third reports (%TEMP%\jplajs2\backlog\JP1_DEFAULT\JP1_DEFAULT_3rd)

| Name of folder or file containing collected data | Description |
|--|--|
| \ALLUSERSPROFILE\jobinf | Folder containing information about jobs |

For logical hosts:

- The data for first reports (%TEMP%\jplajs2\backlog\logical-host-name\logical-host-name_1st)

| Name of folder or file containing collected data | Description |
|--|--------------------------------------|
| \jpomanevshow.txt | Execution result of jpomanevshow.exe |

| Name of folder or file containing collected data | Description |
|--|---|
| \ajsqlstatus.txt | Execution result of ajsqlstatus.exe |
| \ajsagtshow.txt | Execution result of ajsagtshow.exe |
| \ajsagtshow_e.txt | Execution result of ajsagtshow.exe (-e option) |
| \jajs_status.txt | Execution result of jajs_status.exe |
| \ajsprof_scheduler-service-name_agent_stat.txt#1 | Execution result of ajsprofstatus.exe (-t agent -s option) |
| \ajsprof_scheduler-service-name_agent_def.txt#1 | Execution result of ajsprofstatus.exe (-t agent -p option) |
| \ajsprof_scheduler-service-name_unit_stat.txt#1 | Execution result of ajsprofstatus.exe (-t unit -s option) |
| \ajsprof_scheduler-service-name_unit_def.txt#1 | Execution result of ajsprofstatus.exe (-t unit -p option) |
| \jajs_pmtcon_m.txt | Execution result of jajs_pmtcon.exe (-m -v option) |
| \jajs_pmtcon_a.txt | Execution result of jajs_pmtcon.exe (-a -v option) |
| \JP1AJS2_LOGICAL | Folder containing log files |
| \JP1BASE | Folder containing JP1/Base log files |
| \EMBDB_JF*#2\conf | Embedded database definition file |
| \EMBDB_JF*#2\spool | Embedded database failure investigation file |
| \EMBDB_JF*#2\etc | Other information related to the embedded database that is needed for investigation |
| \sys\JP1AJS2 | System folder |
| \tmp\schedule\pd*.trc | Embedded database trace log |
| \user_acl | Folder containing user mapping and authentication settings files |

#1

Information about all scheduler services on the host is collected.

#2

_JF* indicates an embedded database identifier (_JF0, _JF1, _JF2, and so on). A folder is created for each identifier.

- The data for second reports (%TEMP%\jplajs2\backlog\logical-host-name\logical-host-name_2nd)

| Name of folder or file containing collected data | Description |
|--|--|
| 1. \cmdatabase 2. \database 3. \embdatabase_JF*# | Database storage folders |
| \SHMDUMP\ProgMon.shmdump | Information about the shared memory for monitoring processing status |
| \SHMDUMP\coreinfo-host.shmdump | Information about the shared memory for the system management function |
| \SHMDUMP\coreinfo-hostprof.shmdump_ logical-host-name | Information about the shared memory for the operation profile |
| 1. \SHMDUMP\coreinfo-pmtcon_m.shmdump 2. \SHMDUMP\coreinfo-pmtcon_a.shmdump | Information about the shared memory for the connection source restriction function |

| Name of folder or file containing collected data | Description |
|--|--|
| \embdbinfo_JF*# | Detailed information about the embedded database |

#

_JF* indicates an embedded database identifier (_JF0, _JF1, _JF2, and so on). A folder is created for each identifier.

- The data for third reports (%TEMP%\jplajs2\backlog\logical-host-name\logical-host-name_3rd)

| Name of folder or file containing collected data | Description |
|--|--|
| \jobinf | Folder containing information about jobs |

jajs_pmtcon

Format

For JP1/AJS3 - Manager

```
jajs_pmtcon
  [-h logical-host-name]
  {-a|-m}
  [-v|-u]
```

For JP1/AJS3 - Agent

```
jajs_pmtcon
  [-h logical-host-name]
  -a
  [-v|-u]
```

Description

Performs either of the following operations depending on the specified options:

- Enables the contents of the connection permission configuration file.
- Outputs a list of the hosts that are currently permitted to connect.

Execution privileges

In Windows: Administrators privileges

In UNIX: Superuser privileges

Arguments

-h *logical-host-name*

Specifies the name of the logical host for the processing.

You can specify a character string of 1 to 255 bytes.

If you omit this option, the logical host name specified in environment variable JP1_HOSTNAME is assumed. If the JP1_HOSTNAME environment variable has not been specified, the physical host is assumed.

If the local host name is specified and if the local host name is the same as the logical host name, the local host acts as a logical host. If the name is not the same as the logical host name, the host acts as if the physical host had been specified.

If JP1_DEFAULT is specified in the -h option, the KAVS0103-E message is output and the command terminates abnormally. If JP1_DEFAULT is specified in the JP1_HOSTNAME environment variable, the KAVS0187-E message is output and the command terminates abnormally.

-a

Specifies that the connection source restriction function for agents is used for the processing.

If the -m option is specified concurrently, the KAVS0116-E message is output and the command terminates abnormally.

-m

Specifies that the connection source restriction function for managers is used for the processing.

If the `-a` option is specified concurrently, the KAVS0116-E message is output and the command terminates abnormally.

The `-m` option can be specified only in JP1/AJS3 - Manager. If it is specified in JP1/AJS3 - Agent, the KAVS0100-E message is output and the command terminates abnormally.

-v

Outputs the status of the connection source restriction function, the date and time applied, and a list of the IP addresses of the hosts that are currently permitted to connect. If the connection source restriction function is disabled, the date and time and the list are not output.

If the `-u` option is specified concurrently, the KAVS0116-E message is output and the command terminates abnormally.

For an example of the output of this option, see *Output example*.

-u

Enables the contents of the connection permission configuration file.

For details about the connection permission configuration file, see *21.2.2 How to set the connection permission configuration file* in the *JP1/Automatic Job Management System 3 Configuration Guide*.

If the `-v` option is specified concurrently, the KAVS0116-E message is output and the command terminates abnormally.

Return values

| | |
|---------------------|--------------|
| 0 | Normal end |
| Values other than 0 | Abnormal end |

Example

The following command enables the agent connection permission configuration file:

```
jajs_pmtcon -a -u
```

The following command outputs a list of hosts that are permitted to connect to the agent:

```
jajs_pmtcon -a -v
```

Output example

The following shows an example of outputting a list of hosts that are permitted to connect to the agent.

Connection source restriction function of the agent

Status restricted
Apply date Aug 18 2013 10:12:01

List of the connection permitted host of the agent

192.168.0.128
::1

KAVS8030-I The connection permitted hosts are listed successfully.

Notes

- If you want to delete a manager host IP address from the agent connection permission configuration file, make sure that a job has not been requested to execute from the manager host before you execute the command. If you attempt the deletion during execution of a job, internal JP1/AJS communication is refused, and the job cannot be forcibly terminated. If you mistakenly delete the IP address of the manager host and need to forcibly terminate a running job, add the IP address of the manager host to the agent connection permission configuration file and then retry.
- Do not execute multiple instances of this command concurrently. If you do so, the contents of the connection permission configuration file might not be updated correctly.
- If the shared memory used by the connection source restriction function is inadvertently deleted, this command will not operate correctly as explained in the following:
 - If this command is executed with the `-v` option specified, the command outputs *not restricted* as the results, even though the actual status is *restricted*.
 - If this command is executed with the `-u` option specified, the KAVS8034-E message is output and the command terminates abnormally.

For this command to operate correctly, stop both the JP1/AJS3 service and JP1/AJS3 Queueless Agent service, and then restart both services.

jajsshowadminusr (UNIX only)

Format

```
jajsshowadminusr
```

Description

Outputs information about the AJS administrator that has been set.

Execution privileges

Superuser privileges

Arguments

None

Notes

- If an argument is specified, an error message appears, and the command ends abnormally.
- Information current at the time JP1/AJS3 was installed is output. Accordingly, if information about a user or a group is changed by using an OS function or a JP1/Base function after JP1/AJS3 was installed, correct information is not output.

Return values

| | |
|---------------------|--------------|
| 0 | Normal end |
| Values other than 0 | Abnormal end |

jajs_spmd

Format

For JP1/AJS3 - Manager

```
jajs_spmd
  [-h logical-host-name]
  [-n jajs_agtd |
  -n jajs_schd [-F scheduler-service-name] |
  -n jajs_dbmd [-id embedded-database-setup-ID]]
  [-hot|-warm|-cold [-q {clear|noclear}]]|-disaster]
  [-HA]
```

For JP1/AJS3 - Agent

```
jajs_spmd
  [-h logical-host-name]
  [-cold]
  [-HA]
```

Description

For JP1/AJS3 - Manager

The `jajs_spmd` command starts the process that corresponds to a JP1/AJS3 function.

For JP1/AJS3 - Agent

The `jajs_spmd` command starts the JP1/AJS3 service or starts the process that corresponds to a JP1/AJS3 function.

Execution privileges

In Windows: Administrators privileges

In UNIX: Superuser privileges

Storage directory

In Windows:

JP1/AJS3 - Manager-installation-folder\bin\
JP1/AJS3 - Agent-installation-folder\bin\
JP1/AJS3 - Agent-installation-folder\bin\
JP1/AJS3 - Agent-installation-folder\bin\

In UNIX:

/opt/jplajs2/bin/

Arguments

-h *logical-host-name*

Specify the name of the logical host starting the process or services on a cluster system.

You can specify a character string of 1 to 255 bytes.

By default, the system assumes the logical host name specified by the `JP1_HOSTNAME` environment variable. If environment variable `JP1_HOSTNAME` is not specified, the physical host name (which can be determined by the `hostname` command) is assumed.

-n process-name

Specify the name of the process you want to start. You can specify any of the process names shown below.

For JP1/AJS3 - Manager

- `jajs_schd` (Scheduler-service-management)
- `jajs_agtd` (Agent-service-management)
- `jajs_dbmd` (DB management)

If you want to start the scheduler service, specify `jajs_schd` in the `-n` option, and specify the name of the scheduler service in the `-F` option. To start the scheduler service of the logical host, specify both the `-h` and `-F` options.

If you want to start the embedded database, specify `jajs_dbmd` in the `-n` option, and specify the embedded database setup identifier in the `-id` option. To start the embedded database of the logical host, specify both the `-h` and `-id` options.

-F scheduler-service-name

Specify the name of the scheduler service you want to start. You can specify this option only when you specify `jajs_schd` in the `-n` option.

If you want to start the scheduler service with advanced options specified, use the `ajsstart` command. For details on the `ajsstart` command and the `ajsagtpri` command, see [ajsstart in 3. Commands Used for Normal Operations](#).

If you omit this option, the system assumes the default scheduler service name.

-id embedded-database-setup-ID

Specify `_JFn` (where *n* is a value from 0 to 9 or A to Z) as the setup identifier used to identify the embedded database. Specify the value that was specified in the `-id` option of the `ajsembdbbbuild` command.

To operate the embedded database created by using the `jajs_setup`, `jajs_setup_cluster`, and `jajs_migrate` commands, use the `ajsembdbidlist` command to check the setup identifier of the embedded database that will be used. For details about the `ajsembdbidlist` command, see [ajsembdbidlist in 2. Commands Used during Setup](#).

To start the embedded database with advanced options specified, use the `ajsembdbstart` command. For details about the `ajsembdbstart` command, see [ajsembdbstart in 3. Commands Used for Normal Operations](#).

If this option is omitted, `_JF0` is assumed.

-hot | -warm | -cold

Specify the startup mode for the JP1/AJS3 process or services. For the states of jobnets and jobs for each startup mode, see the explanation of states of jobnets and jobs for each startup mode in [6.2.1 Temporarily changing the start mode of JP1/AJS3 in the JP1/Automatic Job Management System 3 Administration Guide](#).

If you specify none of these options when JP1/AJS3 - Manager is used, the value of the `STARTMODE` environment setting parameter is assumed.

- `-hot`
Performs a hot start of JP1/AJS3 (starts the process or services while holding the state available at the end of the previous process or services). You cannot specify this option when you specify `jajs_agtd` or `jajs_dbmd` in the `-n` option.

- `-warm`

Performs a warm start of JP1/AJS3 (starts the process or services while holding the state available at the end of the previous process or services. However, any jobnet being executed at the end of the process or services will be completed and execution will be made according to the schedule on the process or services start day.) You cannot specify this option when you specify `jaajs_agtd` or `jaajs_dbmd` in the `-n` option.

- `-cold`

Performs a cold start of JP1/AJS3 (starts the process by canceling the state available at the end of the previous process or services.) You cannot specify this option when you specify `jaajs_dbmd` in the `-n` option.

-q {clear|noclear}

Selects whether or not to initialize the job information in the job execution environment database at the time of a cold start.

You can specify this option with the `-cold` option, not with any other options.

If this option is omitted, the value of the `ColdStartMode` environment setting parameter is assumed. If specification of the `ColdStartMode` environment setting parameter is in the default status, the job information for the job execution environment database is initialized.

- `clear`

Initializes the job information in the job execution environment database at the time of a cold start. However, initialization does not occur if there is a scheduler service whose setting is not specified as automatic start.

- `noclear`

Does not initialize the job information about the job execution environment database at the time of a cold start.

-disaster

This option starts JP1/AJS3 in disaster recovery mode.

Specify this option to start JP1/AJS3 in disaster recovery mode when operation switches from the main site to the remote site and vice versa.

In disaster recovery mode, JP1/AJS3 - Manager starts with job and jobnet execution suppressed as a precaution.

-HA

Terminates all processes for the JP1/AJS3 process or service, instead of performing a reduced operation, when there is something wrong with the JP1/AJS3 process or services.

Specify this option to fail over the cluster if some JP1/AJS3 processes or services have failed.

If this option is used for a logical host, regardless of the restart option specified in the extended startup process definition file, the processes or services are not restarted. If you want these to be restarted in a cluster system, set cluster software so that they are restarted.

Notes

- You cannot specify the `-n` option while JP1/AJS3 is not running. You can specify the option only when JP1/AJS3 is running and you want to start a process separately.
- If you specify both the `-n` and `-HA` options, the `-HA` option is valid for only the child process specified in the `-n` option.

- Do not execute this command concurrently with the `jajs_start` or `jajs_start.cluster` command. JP1/AJS3 may not start successfully.
- The command terminates without waiting for the process or services to complete its startup. Use the `jajs_spmd_status` command to check whether the JP1/AJS3 process or services has started.
- For the JP1/AJS3 - Manager agent service management function and JP1/AJS3 - Agent, if a process or service error occurs, all agent service management function processes or all JP1/AJS3 services are terminated regardless of the `-HA` option specification. Reduced operation is not performed.
- In Windows, to start a JP1/AJS3 service, use the Services dialog box that is displayed by double-clicking **Administrative Tools** and then **Services** in Windows Control Panel. This operation is equivalent to executing the command without any options in UNIX (on a logical host, the `-h` and `-HA` options have effect).
- Do not execute this command if the process of system termination is being conducted from JP1/Power Monitor during linkage with JP1/Power Monitor.
- You cannot execute this command together with any of the following commands on the same logical host:
 - `ajsprofalter` command
 - `ajsembdbstart` command
 - `ajsembdbstop` command
 - `jajs_hstd` command
 - `jajs_hstd_stop` command
 - `jajs_spmd` command (if the `-n` value is not `jajs_schd`)
 - `jajs_spmd_status` command
 - `jajs_spmd_stop` command (if the `-n` value is not `jajs_schd`)
 - `jajs_start` command (UNIX only)
 - `jajs_start.cluster` command (UNIX only)
 - `jajs_stop` command (UNIX only)
 - `jajs_stop.cluster` command (UNIX only)
- You cannot execute this command together with any of the following commands if the same scheduler service is specified:
 - `ajsstart` command
 - `ajsstop` command
 - `jajs_spmd` command (if the `-n` value is `jajs_schd`)
 - `jajs_spmd_stop` command (if the `-n` value is `jajs_schd`)
- In UNIX, if you want to execute the `jajs_spmd` command by using a remote shell command, disconnect the standard input, standard output, and standard error output. That is, assign `/dev/null` to the standard input, standard output, and standard error output. If you execute the command without disconnecting these, the remote shell command might be unable to terminate when JP1/AJS3 processes or services are started.
- In UNIX, if you have started the JP1/AJS3 service by using this command, do not delete the current directory from which you executed the command. If you are planning to delete the current directory from which you started the JP1/AJS3 service, make sure that the service has terminated before deleting the directory.
- In Windows, this command cannot be executed using short file names.
- If you operate JP1/AJS3 in disaster recovery mode, before executing this command, execute the `jajs_rpsite` command with the `-v` or `-V` option specified to confirm that disaster recovery mode has been set up correctly.

Return values

| | |
|---------------------|--------------|
| 0 | Normal end |
| Values other than 0 | Abnormal end |

Example 1

The following command cold-starts JP1/AJS3.

```
jajs_spmd -cold
```

Example 2

The following command is used to restart only JP1/AJS3 scheduler service AJSROOT1 after the scheduler service has terminated abnormally and the cause of the problem has been solved.

```
jajs_spmd -n jajs_schd -F AJSROOT1
```

jajs_spm�_status

Format

For JP1/AJS3 - Manager

```
jajs_spm�_status
  [-h logical-host-name]
  [-s|_a]
  [-t time]
```

For JP1/AJS3 - Agent

```
jajs_spm�_status
  [-h logical-host-name]
  [-t time]
```

Description

Checks the state of the `jajs_spm�` sub-processes against the `jajs_spm�` process or services.

For details about the `jajs_spm�` sub-processes or services, see *B. List of Processes* in the manual *JP1/Automatic Job Management System 3 Troubleshooting*.

Execution privileges

In Windows: Administrators privileges

In UNIX: Superuser privileges

Storage directory

In Windows:

```
JP1/AJS3 - Manager-installation-folder\bin\  
JP1/AJS3 - Agent-installation-folder\bin\  

```

In UNIX:

```
/opt/jplajs2/bin/
```

Arguments

-h *logical-host-name*

Specify the name of the logical host that you want to check for its status on a cluster system.

You can specify a character string of 1 to 255 bytes.

By default, the system assumes the logical host name specified by the `JP1_HOSTNAME` environment variable. If environment variable `JP1_HOSTNAME` is not specified, the physical host name (which can be determined by the `hostname` command) is assumed.

-s|_a

Specify the objects whose status you want to display for JP1/AJS3 - Manager.

- -s

Specify this option to display only the process status of each component service.

- -a

Specify this option to display the process status of each component service and the status of all processes subordinate to each component service.

-t time

Specify the timeout value for JP1/AJS3 status confirmation. The specified value applies to each process, and is not the timeout value for the entire command execution.

You can specify a value between 0 and 32,767 (seconds).

The default value is 60 seconds. Even if you specify 0, the system assumes that a value of 60 seconds is specified.

If confirmation by the `jajs_spm�_status` command is not terminated within a specified period of time, it is considered that execution of the `jajs_spm�_status` command has failed.

Correspondence between the displayed and actual process names

The following describes the correspondence between the process name output by the `jajs_spm�_status` command and the actual process name.

For details about the process, see *B. List of Processes* in the manual *JP1/Automatic Job Management System 3 Troubleshooting*.

Table 3–29: Correspondence between the process name displayed by the JP1/AJS3 - Manager's `jajs_spm�_status` command and the actual process name (for Windows)

| Process name displayed by the <code>jajs_spm�_status</code> command | Actual process name |
|---|-------------------------------|
| <code>jajs_dbmd</code> | <code>jajs_dbmd.exe</code> |
| <code>ajsdbmgrd#1</code> | <code>ajsdbmgrd.exe</code> |
| <code>jajs_hstd</code> | <code>jajs_hstd.exe</code> |
| <code>hlogd</code> | <code>ajshlogd.exe</code> |
| <code>ajsinetd</code> | <code>ajsinetd.exe</code> |
| <code>network</code> | <code>ajsnetwd.exe</code> |
| <code>queue</code> | <code>jpgman.exe</code> |
| <code>agentm</code> | <code>ajsagtmd.exe</code> |
| <code>submitqueue</code> | <code>jpgman.exe</code> |
| <code>hostevam</code> | <code>jpgmanager.exe</code> |
| <code>gatewayd</code> | <code>ajsgwmasterd.exe</code> |
| <code>ajscdinetd</code> | <code>ajscdinetd.exe</code> |
| <code>ajsovstatd</code> | <code>ajsovstatd.exe</code> |
| <code>qlcltd</code> | <code>ajsqlcltd.exe</code> |
| <code>jajs_agtd</code> | <code>jajs_agtd.exe</code> |
| <code>queuea</code> | <code>jpgmon.exe</code> |
| <code>evactiona</code> | <code>jpoagent.exe</code> |

| Process name displayed by the jajs_spm�_status command | Actual process name |
|--|---------------------|
| jajs_schd | jajs_schd.exe |
| slogd | ajslogd.exe |
| queuem | jpgman.exe |
| evactionm | jpomanager.exe |
| schedule | ajsmasterd.exe |
| agentmon | ajsagtmond.exe |

Table 3–30: Correspondence between the process name displayed by the JP1/AJS3 - Agent's jajs_spm�_status command and the actual process name (for Windows)

| Process name displayed by the jajs_spm�_status command | Actual process name |
|--|---------------------|
| qlcltd | ajsqlcltd.exe |
| queuea | jpgmon.exe |
| evactiona | jpoagent.exe |

Table 3–31: Correspondence between the process name displayed by the JP1/AJS3 - Manager's jajs_spm�_status command and the actual process name (for UNIX)

| Process name displayed by the jajs_spm�_status command | Actual process name |
|--|---------------------|
| jajs_dbmd | jajs_dbmd |
| ajsdbmgrd#1 | ajsdbmgrd |
| jajs_hstd | jajs_hstd |
| ajshlogd | ajshlogd |
| ajsinetd | ajsinetd |
| ajsnetwd | ajsnetwd |
| ajsagtmp | ajsagtmp |
| jpgman_hst | jpgman#2 |
| jpomanager_hst | jpomanager |
| ajsgwmasterd | ajsgwmasterd |
| ajscdinetd | ajscdinetd |
| ajsovstatd | ajsovstatd |
| jajs_agtd | jajs_agtd |
| jpgmon | jpgmon |
| jpoagent | jpoagent |
| jajs_schd | jajs_schd |
| ajslogd | ajslogd |
| jpgman | jpgman |
| jpomanager | jpomanager |

| Process name displayed by the <code>jajs_spmd_status</code> command | Actual process name |
|---|-------------------------|
| <code>ajsmasterd</code> | <code>ajsmasterd</code> |
| <code>ajsagtmond</code> | <code>ajsagtmond</code> |

Table 3–32: Correspondence between the process name displayed by the JP1/AJS3 - Agent's `jajs_spmd_status` command and the actual process name (for UNIX)

| Process name displayed by the <code>jajs_spmd_status</code> command | Actual process name |
|---|-----------------------|
| <code>jpgmon</code> | <code>jpgmon</code> |
| <code>jpoagent</code> | <code>jpoagent</code> |

#1

database (for Windows only) and `ajsembddb` might be displayed when an upgrade installation from v9 to v10 is performed.

#2

In the case of HP-UX, AIX, and Linux, the detailed process name is `jpgman32`.

Notes

- Do not execute this command if the process of system termination is being conducted from JP1/Power Monitor during linkage with JP1/Power Monitor.
- You cannot execute this command together with any of the following commands on the same logical host:
 - `ajspofalter` command
 - `ajsembdbstart` command
 - `ajsembdbstop` command
 - `ajsstart` command
 - `ajsstop` command
 - `jajs_hstd` command
 - `jajs_hstd_stop` command
 - `jajs_spmd` command
 - `jajs_spmd_status` command
 - `jajs_spmd_stop` command
 - `jajs_start` command (UNIX only)
 - `jajs_start.cluster` command (UNIX only)
 - `jajs_stop` command (UNIX only)
 - `jajs_stop.cluster` command (UNIX only)
- In Windows, this command cannot be executed using short file names.

Return values

| | |
|---|--|
| 0 | Any of the following: <ul style="list-style-type: none"> • All processes are being started. • Some processes have been stopped by the <code>jajs_spmd_stop</code> command with the <code>-n</code> option specified or by the <code>ajsstop</code> command. • The command is being stopped. (There are no abnormally terminated processes.) |
|---|--|

| | |
|----|--|
| 1 | <p>Any of the following:</p> <ul style="list-style-type: none"> • An error occurred in, for example, communication with process management. • The shared folder (shared directory) has not been mounted in a cluster system. • Execution permission is not granted. |
| 4 | <p>Any of the following:</p> <ul style="list-style-type: none"> • Some of the processes are being started (There are abnormally terminated processes.). • The command is being started. • The command is being stopped. (There are abnormally terminated processes.) |
| 8 | All processes are being terminated. |
| 12 | <p>Any of the following:</p> <ul style="list-style-type: none"> • An error occurred during the processing of the <code>jajs_spm�_status</code> command, and the process status could not be obtained. • A request to obtain the status of JP1/AJS3 timed out. <p>The <code>jajs_spm�_status</code> command could not obtain the status. This could be a temporary error, so take the following action:</p> <ul style="list-style-type: none"> • Wait a while, and then re-execute the <code>jajs_spm�_status</code> command. • If you execute the <code>jajs_spm�_status</code> command several times and the error persists, handle the situation as an abnormal condition. |

Example

The following command outputs the status of each JP1/AJS3 component service and the status of processes that belong to each JP1/AJS3 component service on logical host `lhost`.

```
jajs_spm�_status -h lhost -a
```

Output example 1

The following shows an output example when the `-a` option is specified for JP1/AJS3 - Manager.

```

KNAD3690-I Processing to report the status of JP1/AJS3 has started.
Display the running processes

  process name  process ID  attribute
  jajs_dbmd    xxxx      _JF0
  ajsdbmgrd    xxxx      _JF0
  jajs_hstd    xxxx
  ajsinetd    xxxx
  network      xxxx
  agentm      xxxx
  submitqueue  xxxx
  hostevam    xxxx
  gatewayd    xxxx
  jajs_agt    xxxx
  evactiona    xxxx
  jajs_schd    xxxx      AJSROOT1
  queuem      xxxx      AJSROOT1
  evactionm    xxxx      AJSROOT1
  schedule    xxxx      AJSROOT1

KNAD3691-I All the processes have started.

```

Output example 2

The following shows an output example when the `-s` option is specified for JP1/AJS3 - Manager.

```
KNAD3690-I Processing to report the status of JP1/AJS3 has started.
Display the running processes

  process name    process ID    attribute
  jajs_dbmd      xxxx         _JF0
  jajs_hstd      xxxx
  jajs_agt       xxxx
  jajs_schd      xxxx         AJSROOT1

KNAD3691-I All the processes have started.
```

Output example 3

The following shows an output example for JP1/AJS3 - Agent.

```
KNAD3690-I Processing to report the status of JP1/AJS3 has started.
Display the running processes

  process name    process ID
  queuea         xxxx
  evactiona      xxxx

KNAD3691-I All the processes have started.
```

The following shows the meaning of the output.

process name

Indicates the process name.

process ID

Indicates the process ID.

attribute

Indicates the setup identifier that identifies the embedded database or the scheduler service name.

jajs_spmd_stop

Format

For JP1/AJS3 - Manager

```
jajs_spmd_stop
  [-h logical-host-name]
  [-n jajs_agtd |
   -n jajs_schd [-F scheduler-service-name] |
   -n jajs_dbmd [-id embedded-database-setup-ID]]
  [-job|-kill]
```

For JP1/AJS3 - Agent

```
jajs_spmd_stop
  [-h logical-host-name]
  [-job|-kill]
```

Description

The `jajs_spmd` command stops the JP1/AJS3 service or stops the process that corresponds to a JP1/AJS3 function.

Execution privileges

In Windows: Administrators privileges

In UNIX: Superuser privileges

Storage directory

In Windows:

```
JP1/AJS3 - Manager-installation-folder\bin\  
JP1/AJS3 - Agent-installation-folder\bin\  

```

In UNIX:

```
/opt/jp1ajs2/bin/
```

Arguments

-h *logical-host-name*

Specify the name of the logical host terminating the process or services on a cluster system.

You can specify a character string of 1 to 255 bytes.

By default, the system assumes the logical host name specified by the `JP1_HOSTNAME` environment variable. If environment variable `JP1_HOSTNAME` is not specified, the physical host name (which can be determined by the `hostname` command) is assumed.

-n *process-name*

Specify the name of the process you want to stop. You can specify any of the process names shown below.

For JP1/AJS3 - Manager

- `jajs_schd` (Scheduler-service-management)
- `jajs_agtd` (Agent-service-management)
- `jajs_dbmd` (Database-management)

If you want to stop the scheduler service, specify `jajs_schd` in the `-n` option, and specify the name of the scheduler service in the `-F` option. To stop the scheduler service of the logical host, specify both the `-h` and `-F` options.

If you want to stop the embedded database, specify `jajs_dbmd` in the `-n` option, and specify the embedded database setup identifier in the `-id` option. To stop the embedded database of the logical host, specify both the `-h` and `-id` options.

If this option is omitted, the command stops all running processes that are specified in the process definition file.

-F scheduler-service-name

Specify the name of the scheduler service you want to stop. You can specify this option only when you specify `jajs_schd` in the `-n` option.

If you want to stop the scheduler service with advanced options specified, use the `ajsstop` command. For details on the `ajsstop` command, see [ajsstop in 3. Commands Used for Normal Operations](#).

If you omit this option, the system assumes the default scheduler service name.

-id embedded-database-setup-ID

Specify `_JFn` (where *n* is a value from 0 to 9 or A to Z) as the setup identifier used to identify the embedded database. Specify the value that was specified in the `-id` option of the `ajsembdbbuild` command.

To operate the embedded database created by using the `jajs_setup`, `jajs_setup_cluster`, and `jajs_migrate` commands, use the `ajsembdbidlist` command to check the setup identifier of the embedded database that will be used. For details about the `ajsembdbidlist` command, see [ajsembdbidlist in 2. Commands Used during Setup](#).

To stop the embedded database with advanced options specified, use the `ajsembdbstop` command. For details about the `ajsembdbstop` command, see [ajsembdbstop in 3. Commands Used for Normal Operations](#).

If this option is omitted, `_JF0` is assumed.

-job|-kill

Specify the termination mode for the JP1/AJS3 process or services.

By default, the command issues a kill request to the jobs that are running with the JP1/AJS3 service specified as an agent (jobs started as processes subordinate to the JP1/AJS3 service), causing the process to be forcibly terminated without waiting for the currently running jobs and jobnets to terminate.

- `-job`
The process or services is terminated after all jobs being executed are terminated.
- `-kill`
The command issues a kill request to the jobs that are running with the JP1/AJS3 service specified as an agent (jobs started as processes subordinate to the JP1/AJS3 service), causing the process or services to be forcibly terminated without waiting for the currently running jobs and jobnets to terminate.

If you execute the command with this option specified when the JP1/AJS3 service is starting or undergoing a planned termination, the command intervenes and immediately kills the process or service. If the JP1/AJS3 service is starting when you execute the command and you do not specify the `-kill` option, an error occurs.

Notes

- This command does not allow you to terminate the following process states:
 - `jpomlsrv` (for Windows)
- This command terminates without waiting for the end of process or services termination. Use the `jaajs_spmd_status` command to check whether the JP1/AJS3 process or services has ended.
- Do not execute this command if the process of system termination is being conducted from JP1/Power Monitor during linkage with JP1/Power Monitor.
- You cannot execute this command together with any of the following commands on the same logical host:
 - `ajsprofalter` command
 - `ajsembdbstart` command
 - `ajsembdbstop` command
 - `jaajs_hstd` command
 - `jaajs_hstd_stop` command
 - `jaajs_spmd` command (if the `-n` value is not `jaajs_schd`)
 - `jaajs_spmd_status` command
 - `jaajs_spmd_stop` command (if the `-n` value is not `jaajs_schd`)
 - `jaajs_start` command (UNIX only)
 - `jaajs_start.cluster` command (UNIX only)
 - `jaajs_stop` command (UNIX only)
 - `jaajs_stop.cluster` command (UNIX only)
- You cannot execute this command together with any of the following commands if the same scheduler service is specified:
 - `ajsstart` command
 - `ajsstop` command
 - `jaajs_spmd` command (if the `-n` value is `jaajs_schd`)
 - `jaajs_spmd_stop` command (if the `-n` value is `jaajs_schd`)
- If the event job execution continuation option is used, the status of an event job and a custom event job on the manager host does not change from *Now running* even if you use this command to stop JP1/AJS3 on the agent host. Therefore, if the `-job` option is used so that the process or services are terminated after all jobs are terminated, the command cannot stop JP1/AJS3. If you use both the event job execution continuation option and the `-job` option, you must ensure that the command is executed when no event jobs and custom event jobs are running. For example, wait for the running event jobs and custom event jobs to terminate, forcibly terminate running event jobs and custom event jobs, or schedule execution of the command so that the command is always executed when event jobs and custom event jobs are terminated.
- In Windows, this command cannot be executed using short file names.

Return values

| | |
|---------------------|--------------|
| 0 | Normal end |
| Values other than 0 | Abnormal end |

Example

The following command stops JP1/AJS3 services after all running jobs terminate.

```
jajs_spmc_stop -job
```

jajs_start (UNIX only)

Format

```
jajs_start
```

Description

The `jajs_start` command starts JP1/AJS3 on the physical host.

This command is executed when the system starts.

The following explains the command's flow of processing.

1. Starts the queueless agent service if it has not started.
2. Starts the queueless file transfer service if it has not started.
3. Starts JP1/AJS3.
4. Starts the JP1/AJS3 Check Manager service if it has not started.
5. Starts the JP1/AJS3 Check Agent service if it has not started.
6. Starts the JP1/AJS3 Autonomous Agent service and the JP1/AJS3 Autonomous Agent Messenger service if they are not running.
7. Executes the `jajs_spmd_status` command, and then waits for a maximum of 60 seconds until JP1/AJS3 starts.
8. Executes the `jajs_spmd_status` command to display the status of JP1/AJS3 processes.

In the initial status when JP1/AJS3 is installed, the definition for startup processing is commented out. That is, startup processing is disabled. If necessary, customize the definition so that startup processing is enabled. For details about customization, see *15.10.1 Setting automatic startup and termination of the JP1/AJS3 service* in the *JP1/Automatic Job Management System 3 Configuration Guide*.

Execution privileges

Superuser privilege

Storage directory

`/etc/opt/jp1ajs2/`

Notes

- This command cannot be executed in Windows.
- JP1/AJS3 might not start correctly if you execute this command together with any of the following commands:
 - `ajsprofalter` command
 - `ajsembdbstart` command
 - `ajsembdbstop` command
 - `ajsstart` command
 - `ajsstop` command
 - `jajs_hstd` command
 - `jajs_hstd_stop` command

```

jajs_spmd command
jajs_spmd_status command
jajs_spmd_stop command
jajs_start command (UNIX only)
jajs_stop command (UNIX only)

```

- Execute this command in an environment in which the `JP1_HOSTNAME` environment variable has not been set. If you execute this command in an environment in which the `JP1_HOSTNAME` environment variable has been set, the command attempts to start JP1/AJS3 on the logical host set in the variable, not JP1/AJS3 on the physical host. If you want to start JP1/AJS3 on the physical host, delete the `JP1_HOSTNAME` environment variable. This command does not support a logical host.
- If you want to execute this command by using a remote shell command, beforehand, make sure that the standard input, the standard output, and the standard error output are disconnected (that is, assign `/dev/null` to these). If you execute the command without disconnecting these, the remote shell command might not terminate when startup of the JP1/AJS3 service is completed.
- In Linux, the maximum size for core file output might be set to 0 in the standard setting. In this case, core dumps are not output.

However, in the default script of the `jajs_start` command, the maximum size for core file output is set when a JP1/AJS3 process starts, so that core dumps can be output.

```

if [ 'uname' = Linux ]; then
    ulimit -c unlimited
fi

```

You can change the above settings to comment lines by adding a hash mark (#) to the beginning of each line as follows:

```

#if [ 'uname' = Linux ]; then
# ulimit -c unlimited
#fi

```

Change the lines to comment lines in the following cases:

- The core file output setting violates the security policies of the host you are using.
- The maximum size for core file output has been changed from the standard setting, and an OS user who is an AJS administrator in the JP1 administrator group executes the `jajs_start` command.

In this case, if the setting lines have not yet been changed to comment lines when the `jajs_start` command is executed, an error message is output to the standard error output.

After the setting lines are changed to comment lines, the maximum size for core file output does not change within the JP1/AJS3 process started by the `jajs_start` command. Note that depending on the occurrence time of a segmentation error, bus error, or another error in a JP1/AJS3 process, an incomplete core dump might be output. Therefore, you might not be able to identify the cause of the error.

Return values

| | |
|---------------------|--------------|
| 0 | Normal end |
| Values other than 0 | Abnormal end |

jajs_start.cluster (UNIX only)

Format

```
jajs_start.cluster  
    [logical-host-name]  
    [jajs_spmd-command-options]
```

Description

Starts JP1/AJS3 in the logical host environment.

This command is used to control the startup of JP1/AJS3 in a cluster system. Before using this command, you must register it in the cluster system.

The following explains the command's flow of processing.

1. Starts the queueless agent service if it has not started.
2. Starts the queueless file transfer service if it is not started.
3. Attaches a logical host to the queueless agent service if no logical host is attached to the service.
4. Executes the `jajs_spmd` command to start a JP1/AJS3 process.
5. Starts the JP1/AJS3 Check Manager service if it has not started.
6. Starts the JP1/AJS3 Check Agent service if it has not started.
7. Starts the JP1/AJS3 Autonomous Agent service and the JP1/AJS3 Autonomous Agent Messenger service if they are not running.
8. Executes the `jajs_spmd_status` command, and then waits for a maximum of 60 seconds until JP1/AJS3 starts. If JP1/AJS3 is unable to start, the logical host of the queueless agent service is detached.
9. Executes the `jajs_spmd_status` command to display the status of JP1/AJS3 processes.

In the initial status when JP1/AJS3 is installed, the definitions for starting services except the JP1/AJS3 processes are commented out. If necessary, customize the definitions so that startup processing is enabled. For details about customization, see *17.2.11 Specifying the settings that control startup and termination of JP1/AJS3 in a logical host environment* in the *JP1/Automatic Job Management System 3 Configuration Guide*.

Execution privileges

Superuser privilege

Storage directory

/etc/opt/jp1ajs2/

Arguments

logical-host-name

Specify the name of the logical host in the logical host environment that will start JP1/AJS3.

You can specify a character string of 1 to 63 bytes.

By default, the system assumes the host name specified in the `JP1_HOSTNAME` environment variable. With this option omitted, the command terminate abnormally if the `JP1_HOSTNAME` environment variable contains nothing.

jajs_spm-d-command-options

Specify the options of the `jajs_spm-d` command. Note that you cannot specify the `-h` option, which is used to specify the logical host name, of the `jajs_spm-d` command.

To set the `-HA` option for the `jajs_spm-d` command, specify `-HA` for *jajs_spm-d-command-options*.

For details about the options, see the description of the *jajs_spm-d* in [3. Commands Used for Normal Operations](#).

Notes

- This command cannot be executed in Windows.
- If you specify options for this command, be sure to specify a logical host name for the first option of the argument.
- You must specify the logical host name if you specify the `jajs_spm-d` command options.
- JP1/AJS3 might not start correctly if you execute this command together with any of the following commands on the same logical host:

`ajsprofalter` command

`ajsembdbstart` command

`ajsembdbstop` command

`ajsstart` command

`ajsstop` command

`jajs_hstd` command

`jajs_hstd_stop` command

`jajs_spm-d` command

`jajs_spm-d_status` command

`jajs_spm-d_stop` command

`jajs_start.cluster` command (UNIX only)

`jajs_stop.cluster` command (UNIX only)

- If you want to execute this command by using a remote shell command, beforehand, make sure that the standard input, the standard output, and the standard error output are disconnected (that is, assign `/dev/null` to these). If you execute the command without disconnecting these, the remote shell command might not terminate when startup of the JP1/AJS3 service is completed.
- In Linux, the maximum size for core file output might be set to 0 in the standard setting. In this case, core dumps are not output.

However, in the default script of the `jajs_start.cluster` command, the maximum size for core file output is set when a JP1/AJS3 process starts, so that core dumps can be output.

```
if [ 'uname' = Linux ]; then
    ulimit -c unlimited
fi
```

You can change the above settings to comment lines by adding a hash mark (`#`) to the beginning of each line as follows:

```
#if [ 'uname' = Linux ]; then
#  ulimit -c unlimited
#fi
```

Change the lines to comment lines in the following cases:

- The core file output setting violates the security policies of the host you are using.
- The maximum size for core file output has been changed from the standard setting, and an OS user who is an AJS administrator in the JP1 administrator group executes the `jaajs_start.cluster` command.

In this case, if the setting lines have not yet been changed to comment lines when the `jaajs_start.cluster` command is executed, an error message is output to the standard error output.

After the setting lines are changed to comment lines, the maximum size for core file output does not change within the JP1/AJS3 process started by the `jaajs_start.cluster` command. Note that depending on the occurrence time of a segmentation error, bus error, or another error in a JP1/AJS3 process, an incomplete core dump might be output. Therefore, you might not be able to identify the cause of the error.

Return values

| | |
|---------------------|--------------|
| 0 | Normal end |
| Values other than 0 | Abnormal end |

jajs_status

Format

```
jajs_status
  [-h logical-host-name | -F scheduler-service-name | -v]
  [-s|-e|-a]
```

Format1 (for checking the operating information about the logical host)

```
jajs_status
  -h logical-host-name
  [-s|-e|-a]
```

Format2 (for checking the operating information about the scheduler service)

```
jajs_status
  -F scheduler-service-name
  [-s|-e|-a]
```

Format3 (for checking the connection information about JP1/AJS3 - View)

```
jajs_status
  -v
```

Format4 (for checking the connection information about JP1/AJS3 - Web Console)

```
jajs_status
  -c
```

Description

The `jajs_status` command is used to check JP1/AJS3 operating information. The command outputs either of the following types of information, or both, according to the specified option:

- Operating information about the system
- Information about the environment setting parameters that are valid during operation

Execution privileges

None

Arguments

-h *logical-host-name*

Specify the name of the logical host for which you want to check operating information.

You can specify a character string of 1 to 255 bytes.

By default, the system assumes the logical host name specified by the `JP1_HOSTNAME` environment variable. If environment variable `JP1_HOSTNAME` is not specified, the physical host name (which can be determined by the `hostname` command) is assumed.

-F scheduler-service-name

If you want to check operating information about a specific scheduler service only, specify the name of the scheduler service.

You can specify a character string of 1 to 30 bytes.

-v

Specify this option to check connection information about JP1/AJS3 - View connected to JP1/AJS3 - Manager.

You can specify this option when the JP1/AJS3 service is running.

You cannot specify this option together with other options.

The information output by this command is the same as the information output by the `ajsstatus` command with the `-v` option specified. For details on the `ajsstatus` command, see [ajsstatus in 3. Commands Used for Normal Operations](#).

-c

Specify this option to check connection information about JP1/AJS3 - Web Console connected to JP1/AJS3 - Manager.

You can specify this option when the JP1/AJS3 service is running.

You cannot specify this option together with other options.

The information output by this command is the same as the information output by the `ajsstatus` command with the `-c` option specified. For details on the `ajsstatus` command, see [ajsstatus in 3. Commands Used for Normal Operations](#).

-s

Specify this option to output the operating information about the system.

You must specify this option with the `-h` and `-F` option. You cannot specify this option with the `-v` option.

-e

Specify this option to output the information about the environment setting parameters that are valid during operation.

You must specify this option with the `-h` and `-F` option. You cannot specify this option with the `-v` option.

-a

Specify this option to output the operating information about the system and the information about the environment setting parameters that are valid during operation.

You must specify this option with the `-h` and `-F` option. You cannot specify this option with the `-v` option.

Notes

- If none of the `-h`, `-F`, or `-v` options are specified, the command assumes that the `-h` option has been specified.
- If none of the `-s`, `-e`, or `-a` options are specified, the command assumes that the `-s` option has been specified.
- If the JP1/AJS3 service is not running, the command terminates abnormally.

Return values

| | |
|---|------------|
| 0 | Normal end |
|---|------------|

| | |
|---------------------|--------------|
| Values other than 0 | Abnormal end |
|---------------------|--------------|

Example 1

The following command outputs the operating information about logical host `HOST_A`.

```
jajs_status -h HOST_A -s
```

Example 2

The following command outputs the operating information about scheduler service `AJSROOT1` and the information about the environment setting parameters that are valid during operation.

```
jajs_status -F AJSROOT1 -a
```

Output example 1

The following shows an example of information output when the `-h` option is specified, and explains the output items.

```

KAVS0829-I Reporting the effective information of JP1/AJS has started.
<Logical host basis information>
Logical host          HOST_A
Status                active
Start time           Oct 23 20XX 15:26
DB construction      standard
Scheduler log file in use C:\Program Files\HITACHI\JP1AJS2\log\ajs-host-log1.log
Alternate scheduler log file C:\Program Files\HITACHI\JP1AJS2\log\ajs-host-log2.log

<Logical host service information>
DB service count     1
DB service           _JF0
Status               active
Start time           Oct 23 20XX 15:26
restart count        0
Host service
Status               active
Start time           Oct 23 20XX 15:26
restart count        0
Agent service
Status               active
Start time           Oct 23 20XX 15:26
restart count        0
Scheduler service count 1
Scheduler service    AJSROOT1
Status               active
Start time           Oct 23 20XX 15:26
restart count        0
EmbedDB setup ID     _JF0

<Logical host environment information>
[HOST_A\JP1AJS2\DB]
DBLOGFILE1           "C:\Program Files\HITACHI\JP1AJS2\log\ajs-db-log1.log"
DBLOGFILE2           "C:\Program Files\HITACHI\JP1AJS2\log\ajs-db-log2.log"
DBLOGSIZE             dword:00002800
DLOGDLOG              "none"
DLOGDSYSLOG           "none"

[HOST_A\JP1AJS2\HOST]
HLOGDLOG              "none"
HLOGDSYSLOG           "none"
HOSTLOGFILE1          "C:\Program Files\HITACHI\JP1AJS2\log\ajs-host-log1.log"
HOSTLOGFILE2          "C:\Program Files\HITACHI\JP1AJS2\log\ajs-host-log2.log"
HOSTLOGSIZE           dword:00002800
HOSTLOGDIR            "C:\Program Files\HITACHI\JP1AJS2\log"
HOSTSYSDIR            "C:\Program Files\HITACHI\JP1AJS2\sys"
:
KAVS0830-I Reporting the effective information of JP1/AJS has terminated.

```

The following shows the meaning of the output.

```
<Logical host basis information>
```

```
Logical host
```

Indicates the logical host name.

```
Status
```

The status of the logical host is output.

- active:
Indicates that JP1/AJS3 on the logical host is operating.
- inactive:
Indicates that JP1/AJS3 on the logical host has stopped.

```
Start time
```

If Status is active, the logical host start time is output in the *MMM DD YYYY hh:mm* format.

If Status is inactive, *** ** ***** **: ** is output.

DB construction

If Status is active, the database configuration (standard) is output.

If Status is inactive, *** is output.

Scheduler log file in use

If Status is active, the name of the scheduler log file in use is output.

If Status is inactive, *** is output.

Alternate scheduler log file

If Status is active, the name of the alternate scheduler log file is output.

If Status is inactive, *** is output.

<Logical host service information>

The following items are output for each service:

DB service count

The number of database services is output.

DB service

The setup identifier of the database service is output.

Status

The status of the database service is output.

- active:
Indicates that the database service is operating.
- inactive:
Indicates that the database service has stopped.

Start time

If Status is active, the database service start time is output in the *MMM DD YYYY hh:mm* format.

If Status is inactive, *** ** ***** **: ** is output.

restart count

If Status is active, the number of times the database service was restarted is output.

If Status is inactive, *** is output.

Host service

Status

The status of the host service is output.

- active:
Indicates that the host service is operating.
- inactive:
Indicates that the host service has stopped.

Start time

If Status is active, the host service start time is output in the *MMM DD YYYY hh:mm* format.

If Status is inactive, *** ** ***** **: ** is output.

restart count

If Status is active, the number of times the host service was restarted is output.

If Status is inactive, *** is output.

Agent service

Status

The status of the agent service is output.

- active:
Indicates that the agent service is operating.
- inactive:
Indicates that the agent service has stopped.

Start time

If Status is active, the agent service start time is output in the *MMM DD YYYY hh:mm* format.

If Status is inactive, *** ** ***** **: ** is output.

restart count

If Status is active, the number of times the agent service was restarted is output.

If Status is inactive, *** is output.

Scheduler service count

The number of scheduler services is output.

Scheduler service

The name of the scheduler service is output.

Status

The status of the scheduler service is output.

- active:
Indicates that the scheduler service is operating.
- inactive:
Indicates that the scheduler service has stopped.

Start time

If Status is active, the scheduler service start time is output in the *MMM DD YYYY hh:mm* format.

If Status is inactive, *** ** ***** **: ** is output.

restart count

If Status is active, the number of times the scheduler service was restarted is output.

If Status is inactive, *** is output.

EmbedDB setup ID

The embedded database setup identifier is output.

<Logical host environment information>

Information about the environment setting parameter for the definition keys below is output. These definition keys are available while a logical host is running.

- [{JP1_DEFAULT|*logical-host-name*} \JP1AJS2\DB]
- [{JP1_DEFAULT|*logical-host-name*} \JP1AJS2\HOST] and the definition key in the directory
- [{JP1_DEFAULT|*logical-host-name*} \JP1AJS2COMMON]

For details about environment setting parameter, see 20. *Environment Setting Parameters* in the *JPI/Automatic Job Management System 3 Configuration Guide*.

Output example 2

The following shows an example of information output when the -F option is specified, and explains the output items.

```
KAVS0829-I Reporting the effective information of JP1/AJS has started.
<Scheduler service basis information>
Scheduler service      AJSROOT1
Status                active
Start time            Oct 23 20XX 15:26
restart count         0
EmbedDB setup ID      _JF0
Scheduler log file in use C:\Program Files\HITACHI\JP1AJS2\log\ajs-host-log1.log
Alternate scheduler log file C:\Program Files\HITACHI\JP1AJS2\log\ajs-host-log2.log

<Scheduler service function information>
Scheduler function
Status                active
Start time            Oct 23 20XX 15:29
restart count         0
Termination restriction none

<Scheduler service environment information>
[JP1_DEFAULT\JP1AJSMANAGER]
DEFAULTSERVICENAME    "AJSROOT1"
EVENTRETRY            "no"
IPC_LOCALTIMEOUT      dword:00000000
IPC_TIMEOUT           dword:00000000
IPCRETRYCOUNT        dword:00000003
IPCRETRYINTERVAL     dword:00000001
QLMANCHARCODE        "none"
REUSELOGON            "no"
TRACELOGFILE          "C:\Program Files\HITACHI\JP1AJS2\log\tracelog"
VRSHIFT_IMMINT        "5"
VRSHIFT_INTRERUN     "5"

[JP1_DEFAULT\JP1AJSMANAGER]
AJSINETDLOGSIZE      dword:00000080
AUTHLOG              "none"
AUTHSYSLOG           "none"
EVACONDREQRTT        dword:000001d6
HIDEOOTHERLHOST      "yes"
LOGONSHMAX           dword:00000032
MAXSESSION           dword:00000032
MONLOG               "none"
MONSYSLOG            "none"
REUSELOGON           "no"
:
KAVS0830-I Reporting the effective information of JP1/AJS has terminated.
```

The following shows the meaning of the output.

<Scheduler service basis information>

Scheduler service

Indicates the scheduler service name.

Status

The status of the scheduler service is output.

- active:
Indicates that the scheduler service is operating.
- inactive:
Indicates that the scheduler service has stopped.

Start time

If Status is active, the scheduler service start time is output in the *MMM DD YYYY hh:mm* format.

If Status is inactive, **** ** ***** **: *** is output.

restart count

If Status is active, the number of times the scheduler service was restarted is output.

If Status is inactive, ***** is output.

EmbedDB setup ID

The embedded database setup identifier is output.

Scheduler log file in use

If Status is active, the name of the scheduler log file in use is output.

If Status is inactive, ***** is output.

Alternate scheduler log file

If Status is active, the name of the alternate scheduler log file is output.

If Status is inactive, ***** is output.

<Scheduler service function information>

The following items are output as information about the specified scheduler service:

Status

The status of the scheduler function is output.

- active:
Indicates that the scheduler function is operating.
- inactive:
Indicates that the scheduler function has stopped.

Start time

If Status is active, the scheduler function start time is output in the *MMM DD YYYY hh:mm* format.

If Status is inactive, **** ** ***** **: *** is output.

restart count

If Status is active, the number of times the scheduler function was restarted is output.

If Status is inactive, ***** is output.

Termination restriction

If Status is active, the termination restriction status is output.

- none:
Indicates that the `ajstop` command has not been executed.
- schedule:
Indicates that the system is monitoring termination according to schedule restrictions.
- jobnet:
Indicates that the system is monitoring termination according to jobnet restrictions.
- job:
Indicates that the system is monitoring termination according to job restrictions.
- kill:
Indicates that the system has been stopped forcibly.

- terminate:
Indicates that the system has stopped.
- reset:
Indicates that termination restriction has been reset.

If Status is inactive, *** is output.

<Scheduler service environment information>

Information about the environment setting parameter for the definition keys below is output. These definition keys are available while a scheduler service is running.

- [JP1_DEFAULT\JP1AJSMANAGER]
The environment setting parameters that are common to the system
- [{JP1_DEFAULT|*logical-host-name*}\JP1AJSMANAGER]
The environment setting parameters that are common to the logical host where the scheduler service that is specified in the -F option exists
- [{JP1_DEFAULT|*logical-host-name*}\JP1AJSMANAGER*scheduler-service-name*] and the definition key in the directory
The environment setting parameters for the scheduler service that is specified in the -F option

For details about environment setting parameter of the scheduler service, see 20. *Environment Setting Parameters* in the *JP1/Automatic Job Management System 3 Configuration Guide*.

Output example 3

The following is an example of information output when the database to be used is an external database and a description of the output items. For details about other items, see output examples 1 and 2.

KAVS0829-I Reporting the effective information of JP1/AJS has started.

<Logical host basis information>

| | |
|------------------------------|--|
| Logical host | JP1_DEFAULT |
| Status | active |
| Start time | Oct 23 20XX 15:26 |
| DB construction | standard |
| Database type | SQLSVR |
| Scheduler log file in use | /var/opt/jp1ajs2/log/ajs-host-log1.log |
| Alternate scheduler log file | /var/opt/jp1ajs2/log/ajs-host-log2.log |

<Logical host service information>

| | |
|----------------------------|-------------------------|
| Host service | |
| Status | active |
| Start time | Oct 23 20XX 15:26 |
| restart count | 0 |
| Agent service | |
| Status | active |
| Start time | Oct 23 20XX 15:26 |
| restart count | 0 |
| Scheduler service count | 1 |
| Scheduler service | |
| Status | active |
| Start time | Oct 23 20XX 15:26 |
| restart count | 0 |
| ODBC file data source name | /odbc/ajsdatasource.dsn |
| Database name | AJSROOT1DB |

<Logical host environment information>

| | |
|-----------------------|--|
| [HOST_A\JP1AJS2\DB] | |
| DBLOGFILE1 | "/var/opt/jp1ajs2/log/ajs-db-log1.log" |
| DBLOGFILE2 | "/var/opt/jp1ajs2/log/ajs-db-log2.log" |
| DBLOGSIZE | dword:00002800 |
| DLOGDLOG | "none" |
| DLOGSYSLOG | "none" |
| [HOST_A\JP1AJS2\HOST] | |
| HLOGDLOG | "none" |
| HLOGSYSLOG | "none" |
| HOSTLOGFILE1 | "/var/opt/jp1ajs2/log/ajs-host-log1.log" |
| HOSTLOGFILE2 | "/var/opt/jp1ajs2/log/ajs-host-log2.log" |
| HOSTLOGSIZE | dword:00002800 |
| HOSTLOGDIR | "/var/opt/jp1ajs2/log" |
| HOSTSYSDIR | "/var/opt/jp1ajs2/sys" |
| : | |

```

<Scheduler service basis information>
Scheduler service      AJSROOT1
Status                active
Start time            Oct 23 20XX 15:26
restart count         0
ODBC file data source name /odbc/ajsdatasource.dsn
Database name         AJSROOT1DB
Scheduler log file in use /var/opt/jp1ajs2/log/schedule/AJSROOT1/ajs-log1.log
Alternate scheduler log file /var/opt/jp1ajs2/log/schedule/AJSROOT1/ajs-log2.log

<Scheduler service function information>
Scheduler function
Status                active
Start time            Oct 23 20XX 15:29
restart count         0
Termination restriction none

<Scheduler service environment information>
[JP1_DEFAULT\JP1AJSMANAGER]
DEFAULTSERVICENAME    "AJSROOT1"
EVENTRETRY            "no"
IPC_LOCALTIMEOUT      dword:00000000
IPC_TIMEOUT           dword:00000000
IPCRETRYCOUNT        dword:00000003
IPCRETRYINTERVAL      dword:00000001
QLMANCHARCODE         "none"
REUSELOGON            "no"
TRACELOGFILE          "/var/opt/jp1ajs2/log/tracelog"
VRSHIFT_IMMINT        "5"
VRSHIFT_INTRERUN      "5"

[JP1_DEFAULT\JP1AJSMANAGER]
AJSINETDLOGSIZE       dword:00000080
AUTHLOG                "none"
AUTHSYSLOG             "none"
EVACONDREQRTT         dword:000001d6
HIDEOOTHERLHOST       "yes"
LOGONSHMAX             dword:00000032
MAXSESSION            dword:00000032
MONLOG                 "none"
MONSYSLOG              "none"
REUSELOGON            "no"
:

KAVS0830-I Reporting the effective information of JP1/AJS has terminated.

```

The following shows the meaning of the output.

<Logical host basis information>

Database type

Indicates the database type. This item is output only if the DB construction is standard and the database is an external database.

For external databases (Microsoft SQL Server), SQLSVR is displayed.

<Logical host service information>

ODBC file data source name

Indicates the ODBC file data source name used for connecting to the external database. This item is output only if the DB construction is standard and the database type is SQLSVR.

Database name

Indicates the name of the database on the external database that stores scheduler service information. This item is output only if the DB construction is standard and the database type is SQLSVR.

<Logical host service environment information>

Information about the environment setting parameter related to the connection information of the external database is output.

- [{JP1_DEFAULT|*logical-host-name*} \JP1AJS2\HOST\AGENTMANAGER]

For details about the environment setting parameter, see 20. *Environment Setting Parameters* in the *JP1/Automatic Job Management System 3 Configuration Guide*.

<Scheduler service basis information>

ODBC file data source name

Indicates the ODBC file data source name used for connecting to the external database. This item is output only if the DB construction is standard and the database type is SQLSVR.

Database name

Indicates the name of the database on the external database that stores scheduler service information. This item is output only if the DB construction is standard and the database type is SQLSVR.

<Scheduler service environment information>

Information about the environment setting parameter related to the connection information of the external database is output.

- [{JP1_DEFAULT|*logical-host-name*} \JP1AJSMANAGER*scheduler-service-name*]

For details about the environment setting parameters for the scheduler service, see 20. *Environment Setting Parameters* in the *JP1/Automatic Job Management System 3 Configuration Guide*.

jajs_stop (UNIX only)

Format

```
jajs_stop
```

Description

The `jajs_stop` command stops JP1/AJS3 on the physical host.

This command is executed when the system stops.

The following explains the command's flow of processing.

1. The `jajs_spmd_stop` command is executed to stop JP1/AJS3.
2. The JP1/AJS3 Autonomous Agent service and the JP1/AJS3 Autonomous Agent Messenger service are stopped.
3. The JP1/AJS3 Check Manager service and the JP1/AJS3 Check Agent service are stopped.
4. The `ps` command is executed to monitor the `jajs_spmd` process, and the `jajs_stop` command waits until JP1/AJS3 stops.
5. The queueless agent service is stopped.
6. The queueless file transfer service is stopped.

In the initial status when JP1/AJS3 is installed, the definition for stop processing is commented out. That is, stop processing is disabled. If necessary, customize the definition so that stop processing is enabled. For details about customization, see *15.10.1 Setting automatic startup and termination of the JP1/AJS3 service* in the *JP1/Automatic Job Management System 3 Configuration Guide*.

Execution privileges

Superuser privilege

Storage directory

`/etc/opt/jplajs2/`

Notes

- This command cannot be executed in Windows.
- JP1/AJS3 might not stop correctly if you execute this command together with any of the following commands:
 - `ajsprofalter` command
 - `ajsembdbstart` command
 - `ajsembdbstop` command
 - `ajsstart` command
 - `ajsstop` command
 - `jajs_hstd` command
 - `jajs_hstd_stop` command
 - `jajs_spmd` command
 - `jajs_spmd_status` command
 - `jajs_spmd_stop` command

`jajs_start` command (UNIX only)

`jajs_stop` command (UNIX only)

- Execute this command in an environment in which the `JP1_HOSTNAME` environment variable has not been set. If you execute this command in an environment in which the `JP1_HOSTNAME` environment variable has been set, the command attempts to stop JP1/AJS3 on the logical host set in the variable, not JP1/AJS3 on the physical host. If you want to stop JP1/AJS3 on the physical host, delete the `JP1_HOSTNAME` environment variable. This command does not support a logical host.

Return values

| | |
|---------------------|--------------|
| 0 | Normal end |
| Values other than 0 | Abnormal end |

jajs_stop.cluster (UNIX only)

Format

```
jajs_stop.cluster  
    [logical-host-name]  
    [jajs_spmd_stop-command-option]
```

Description

Stops JP1/AJS3 in the logical host environment.

This command is used to control the stop of JP1/AJS3 in a cluster system. Before using this command, you must register it in the cluster system.

The following explains the command's flow of processing.

1. Stops the JP1/AJS3 processes.
2. The JP1/AJS3 Autonomous Agent service and the JP1/AJS3 Autonomous Agent Messenger service are stopped.
3. Stops the JP1/AJS3 Check Manager service and the JP1/AJS3 Check Agent service.
4. Executes the `ps` command to monitor the `jajs_spmd` process, and then waits for a maximum of 60 seconds until JP1/AJS3 stops.
5. Detaches the logical host from the queueless agent service if the logical host has been attached to the queueless agent service.
6. Stops the queueless agent service.
7. Stops the queueless file transfer service.

In the initial status when JP1/AJS3 is installed, the definitions for stopping services except the JP1/AJS3 processes are commented out. If necessary, customize the definitions so that stop processing is enabled. For details about customization, see *17.2.11 Specifying the settings that control startup and termination of JP1/AJS3 in a logical host environment* in the *JP1/Automatic Job Management System 3 Configuration Guide*.

Execution privileges

Superuser privilege

Storage directory

/etc/opt/jp1ajs2/

Arguments

logical-host-name

Specify the name of the logical host in the logical host environment that will stop JP1/AJS3.

You can specify a character string of 1 to 63 bytes.

By default, the system assumes the host name specified in the `JP1_HOSTNAME` environment variable. With this option omitted, the command terminate abnormally if the `JP1_HOSTNAME` environment variable contains nothing.

jajs_spmd_stop-command-option

Specify the option of the `jajs_spmd_stop` command. Note that you cannot specify the `-h` option, which is used to specify the logical host name, of the `jajs_spmd` command. For details about the option, see the description of the *jajs_spmd_stop* in 3. *Commands Used for Normal Operations*.

Notes

- This command cannot be executed in Windows.
- If you specify options for this command, be sure to specify a logical host name for the first option of the argument.
- JP1/AJS3 might not stop correctly if you execute this command together with any of the following commands on the same logical host:
 - `ajsprofalter` command
 - `ajsembdbstart` command
 - `ajsembdbstop` command
 - `ajsstart` command
 - `ajsstop` command
 - `jajs_hstd` command
 - `jajs_hstd_stop` command
 - `jajs_spmd` command
 - `jajs_spmd_status` command
 - `jajs_spmd_stop` command
 - `jajs_start.cluster` command (UNIX only)
 - `jajs_stop.cluster` command (UNIX only)
- You must specify the logical host name if you specify the `jajs_spmd_stop` command options.

Return values

| | |
|---------------------|--------------|
| 0 | Normal end |
| Values other than 0 | Abnormal end |

jajs_web (Linux only)

Format

```
jajs_web  
  [-t {http|app}]
```

Description

Starts the JP1/AJS3 HTTP Server service and the JP1/AJS3 Web Application Server service.

Execution privileges

Superuser privilege

Storage directory

/etc/opt/jp1ajs3web/

Arguments

-t {http|app}

- http
Starts the JP1/AJS3 HTTP Server service.
- app
Starts the JP1/AJS3 Web Application Server service.

If you omit this option, the JP1/AJS3 Web Application Server service and the JP1/AJS3 HTTP Server service start in this order.

Note

- This command applies only to Linux. You cannot use this command in Windows.
- If an attempt to start the JP1/AJS3 Web Application Server service fails, stop processing of this service might be performed within the command, causing the KNAK2525-E message to be displayed together with the KNAK2524-E message. In this case, no action is required for the KNAK2525-E message.
- If you execute this command with options omitted, startup processing is performed for JP1/AJS3 Web Application Server, and then for JP1/AJS3 HTTP Server. If an error occurs in the JP1/AJS3 HTTP Server service during startup, the JP1/AJS3 Web Application Server service is still running. The following table lists the services in which an error occurred and the status of each service.

Table 3–33: Services in which an error occurred and the service status

| Service status | Service in which an error occurred | |
|---|------------------------------------|----------------------|
| | JP1/AJS3 Web Application Server | JP1/AJS3 HTTP Server |
| Status of JP1/AJS3 Web Application Server | Stop | Running |
| Status of JP1/AJS3 HTTP Server | Stop | Stop |

- If an attempt is made to start JP1/AJS3 HTTP Server while it is already running, the KNAK2524-E message is displayed and the command terminates abnormally.

- By default, the JP1/AJS3 HTTP Server service is started by a user with nobody or root privileges. If an attempt to start the service fails and the KNAK2524-E message is displayed, make sure that a *nobody* user exists in the system. If a nobody user does not exist, create that user or specify existing users in the following sections in *User* in the `/opt/jp1ajs3web/uCPSB/httpsd/conf/httpsd.conf` file:
 - User nobody
 - Group root

Return values

| | |
|---------------------|--------------|
| 0 | Normal end |
| Values other than 0 | Abnormal end |

jajs_web_stop (Linux only)

Format

```
jajs_web_stop  
  [-t {http|app}]
```

Description

Stops the JP1/AJS3 HTTP Server service and the JP1/AJS3 Web Application Server service.

Execution privileges

Superuser privilege

Storage directory

/etc/opt/jp1ajs3web/

Arguments

-t {http|app}

- http
Stops the JP1/AJS3 HTTP Server service.
- app
Stops the JP1/AJS3 Web Application Server service.

If you omit this option, the JP1/AJS3 HTTP Server service and the JP1/AJS3 Web Application Server service stop in this order.

Note

- This command applies only to Linux. You cannot use this command in Windows.
- If the JP1/AJS3 HTTP Server service was forcibly terminated last time because, for example, power was turned off, you need to restart the JP1/AJS3 HTTP Server service before executing this command. If you use this command to stop the JP1/AJS3 HTTP Server service before restarting it, the KNAK2525-E message is displayed and the command terminates abnormally.
- Note that when the JP1/AJS3 Web Application Server service stops, the command might terminate with the KNAK2715-W message displayed even if no error message or warning message was output. In such a case, no action is required for the KNAK2715-W message. This situation occurs because some processes have already been stopped internally, and the message indicates that stop processing of the JP1/AJS3 Web Application Server service has completed normally.

Return values

| | |
|---------------------|--------------|
| 0 | Normal end |
| Values other than 0 | Abnormal end |

jp1exec (Windows only)

Format

```
jp1exec  
    command-line
```

Description

The `jp1exec` command executes the program (`command`) specified on the command line, and saves the return code of the executed program in a temporary file. For details about this temporary file, see [Additional information](#) below.

This command is used in a batch file (`.bat` or `.cmd`) executed as a job on the target host. Normally, when a job is forcibly terminated, the batch file executed as the job is forcibly terminated but the programs executed from the batch file are not forcibly terminated. However, if a program is executed via the `jp1exec` command in a batch file, the program is forcibly terminated when the batch file is forcibly terminated. If you specify the `jp1exit` command at the end of a batch file, the return code of the program executed by the `jp1exec` command can be used as the return code of the batch file.

Execution privileges

None

Arguments

command-line

Specify the full path name of an executable file that you want to execute as a job on the target host. You can also specify arguments (parameters) for the executable file. As an executable file, you can only specify a file whose extension is `exe`. If you specify a file whose extension is not `exe`, the corresponding job might end abnormally.

You can specify a character string of 1 to 259 bytes.

The system behavior differs depending on whether the number of characters in the first argument exceeds the maximum or the total number of characters on the command line exceeds the maximum.

- If the number of characters in the first argument exceeds the maximum
The command results in an error.
- If the total number of characters on the command line exceeds the maximum
The system assumes that only the space-separated elements existing within the maximum length are specified on the command line.

Example:

```
jp1exec C:\test.exe aaa...a
```

If the number of characters in `C:\test.exe aaa...a` exceeds the maximum, the system discards `aaa...a` and executes the command using `C:\test.exe`.

Notes

1. This command cannot be used in UNIX.
2. This command can be used only in JP1/AJS3. It cannot be used for a request from JP1/AJS3 to JP1/OJE for VOS3.
3. This command cannot be used for flexible jobs.

- If multiple `jp1exec` commands are specified in one batch file, the return code of the program executed by the last `jp1exec` command is saved in a temporary file as the return code of the batch file.
- Only a file having the `EXE` extension can be specified in this command. If a file whose extension is not `EXE` is specified, the job might terminate abnormally. Code the following command to call from one batch file to another.

```
jp1exec CMD.EXE /C file-name
```

Note, however, that if a batch file that contains the above coding is terminated forcibly (`CMD.EXE` is terminated forcibly), the programs started from the batch file are not terminated forcibly. To terminate these programs forcibly, make sure that the programs are executed by the `jp1exec` command.

The result of the `EXE` file or batch file called from the `jp1exec` command cannot be redirected to the standard output file or the standard error output file.

- If the `jp1exec` command is executed in a batch file called from another batch file being executed as a job, forcibly terminating the batch file being executed as a job also forcibly terminates the processes executed by the command.
- The return code of the `jp1exec` command is different from the return code of the program executed by the `jp1exec` command. To acquire the return code of the program executed by the `jp1exec` command, you must also specify the `jp1exit` command. If you do not specify the `jp1exit` command, the return code of the `jp1exec` command itself becomes the return code of the batch file. For details on the `jp1exit` command, see *jp1exit (Windows only)* in *3. Commands Used for Normal Operations*.
- Of the environment variables in a batch file, you must not change those environment variables starting with `TMP`, `TEMP`, or `JP1` or those environment variables starting with `AJS`.
- If you use a path name that includes a space character for the file specified by the `jp1exec` command, you must enclose the path name by double quotation marks (") and (\"). If you do not enclose the path with these symbols, the command may fail.

The following is an example in which the execution file name is `C:\Program Files\test.exe`.

```
jp1exec "\"C:\Program Files\test.exe\""
```

- To execute the command, set write privileges and read privileges for the OS user who executes the job on the following folders:

If the `JP1/AJS3` installation folder is the default installation folder or is in a folder protected by the system:

- `%ALLUSERSPROFILE%\Hitachi\JP1\JP1_DEFAULT\JP1AJS2\log\jppqagent`
- `%ALLUSERSPROFILE%\Hitachi\JP1\JP1_DEFAULT\JP1AJS2\log\jppqclient`

The default of the `%ALLUSERSPROFILE%` value is `system-drive\ProgramData`.

If the `JP1/AJS3` installation folder is other than the above:

- `JP1/AJS3-installation-folder\log\jppqagent`
- `JP1/AJS3-installation-folder\log\jppqclient`

When using the system in a cluster configuration:

- `shared-folder\jp1ajs2\log\jppqagent`
- `shared-folder\jp1ajs2\log\jppqclient`

Additional information

If you use the `jp1exec` command, make sure that you also specify the `jp1exit` command. If you do not specify the `jp1exit` command, a file whose name begins with `AJSJP1EXEC` remains on the host on which the job is executed. If this file, which is no longer necessary, remains, delete it manually.

This file is created at the first path found in the environment variables searched in the order shown below. If no path is set in any of the environment variables, the file is created in the Windows installation folder.

1. Environment variable `tmp` of the user[#] that starts the JP1/AJS3 service
2. System environment variable `tmp`
3. Environment variable `temp` of the user[#] that starts the JP1/AJS3 service
4. System environment variable `temp`

For the paths set for the above environment variables, set write and read permissions so that they can be accessed by the OS user who executes the job.

#

For a queueless job, the user who starts a queueless agent service.

jp1exit (Windows only)

Format

```
jp1exit  
    [-ec abnormal-return-code]
```

Description

After the return code of the program (command) executed by the `jp1exec` command has been saved, the `jp1exit` command is used to acquire the return code.

Execution privileges

None

Arguments

-ec *abnormal-return-code*

Specify the return code to be returned if an internal error of the `jp1exit` command occurs.

You can specify 0 to 9,999.

If this option is omitted, 172 is set as the return code returned by the `jp1exit` command when an error occurs.

If an invalid value is specified, 172 is used as the return code of the `jp1exit` command. The details of the error are output to the standard error output.

Notes

1. This command cannot be used in UNIX.
2. This command can be used only in JP1/AJS3. It cannot be used for a request from JP1/AJS3 to JP1/OJE for VOS3.
3. This command cannot be used for flexible jobs.
4. The `jp1exec` command returns its own return code, which is different from the return code of the program executed by the `jp1exec` command.
If it is necessary to evaluate the return code of the `jp1exec` command itself, use `%ERRORLEVEL%` or another means to perform error judgment before the `jp1exit` command is executed.
5. The return code of the program executed by the `jp1exec` command can be executed only when the `jp1exit` command is used.

If you want processing to branch according to the return code of the program executed by the `jp1exec` command, specify the `jp1exec` and `jp1exit` commands in pairs (see [Example](#) below).

If the `jp1exit` command is not executed after the `jp1exec` command is executed, or if the `jp1exit` command is executed more than once in succession without executing the `jp1exec` command, the `jp1exit` command results in an error. In this case, it is not guaranteed that the return code is correct.

If you want to use the return code of the program executed by the `jp1exec` command as the return code of the batch file, make sure that the `jp1exit` command is executed at the end of the processing executed by the batch file. If execution of the `jp1exit` command is followed by some processing (such as another command), the return code of the batch file might be replaced.

6. If the file specified as an argument in the `jplexec` command does not exist, the command sends error details to the standard error output, and terminates. In this case, the `jplexit` command returns 0 as the return code.

7. To execute the command, set write privileges and read privileges for the OS user who executes the job on the following folders:

If the JP1/AJS3 installation folder is the default installation folder or is in a folder protected by the system:

- %ALLUSERSPROFILE%\Hitachi\JP1\JP1_DEFAULT\JP1AJS2\log\jppqagent
- %ALLUSERSPROFILE%\Hitachi\JP1\JP1_DEFAULT\JP1AJS2\log\jppqclient

The default of the %ALLUSERSPROFILE% value is *system-drive*\ProgramData.

If the JP1/AJS3 installation folder is other than the above:

- *JP1/AJS3-installation-folder*\log\jppqagent
- *JP1/AJS3-installation-folder*\log\jppqclient

When using the system in a cluster configuration:

- *shared-folder*\jplajs2\log\jppqagent
- *shared-folder*\jplajs2\log\jppqclient

Example

The following example checks the return code of the executed program to branch subsequent processing:

```
jplexec UAP1.exe
jplexit
if %ERRORLEVEL% =0 GOTO :next1

Error handling
GOTO :end

:next1
jplexec UAP2.exe
jplexit
if %ERRORLEVEL% =0 GOTO :next2

Error handling
GOTO :end

:next2
jplexec UAP3.exe
jplexit
if %ERRORLEVEL% =0 GOTO :next3

Error handling
GOTO :end
```

Explanation:

When the last `jplexit` command is executed, the return code of the program executed by the paired `jplexec` command becomes the return code of the batch file.

If an error occurs and processing branches to `:end`, the return code of the last program executed after the corresponding error handling becomes the return code of the batch file.

jpoagoec

Format

```
jpoagoec  
  {-a manager-host-name|-d manager-host-name|-r|-p}  
  [-h host-name]
```

Description

Changes the requesting manager host name stored by the event action agent process according to the change in the manager host name if event jobs or custom event jobs are used.

In operating event jobs and custom event jobs, the agent stores the requesting manager host name to coordinate the event jobs and custom event jobs through communication between the agent and manager. Therefore, a change in the manager host name requires you to change the requesting manager host name engaged in monitoring JP1/AJS3 event reception that is stored by the agent host or manager host having executed the command. (Using the `jpoagoec` command, display and check the manager host names that have been stored. Delete any unnecessary host names and add any necessary ones.)

Execution privileges

In Windows: Administrators privilege

In UNIX: Superuser privilege

Arguments

-a *manager-host-name*

Specify the manager host name to be added.

You can specify a character string of 1 to 255 bytes.

-d *manager-host-name*

Specify the manager host name to be deleted.

You can specify a character string of 1 to 255 bytes.

-r

Deletes all manager host names.

-p

Outputs the list of the stored manager host names to the standard output file.

-h *host-name*

Specify the logical host name for JP1/AJS3 - Manager or JP1/AJS3 - Agent which is responsible for maintenance (adding, deleting, and displaying manager host names).

You can specify a character string of 1 to 196 bytes.

By default, the system assumes operation using the physical host.

Notes

- Before executing this command, be sure to stop JP1/AJS3.
- Execute this command after terminating all the event jobs and the custom event jobs that are running on the agent host. To check whether event jobs or custom event jobs are running on the agent host, use the `ajsshow` command. For details about the `ajsshow` command, see *ajsshow* in [3. Commands Used for Normal Operations](#).
- This command always needs one of the following options: `-a`, `-d`, `-r`, or `-p`.

Return values

| | |
|---------------------|--------------|
| 0 | Normal end |
| Values other than 0 | Abnormal end |

Example

This example changes the manager host name from `ManagerHostB` to `ManagerHostC`. The following flow shows how the change is made.

1. Confirming the manager host name

Confirm the manager host name that the event action agent feature has stored.

Command to be executed:

```
jpoagoec -p
```

Display example:

```
ManagerHostA  
ManagerHostB
```

2. Deleting the manager host name

Delete the manager host name to be changed.

Command to be executed:

```
jpoagoec -d ManagerHostB
```

3. Adding the changed manager host name

Command to be executed:

```
jpoagoec -a ManagerHostC
```

4. Confirming that the manager host name has been added

Command to be executed:

```
jpoagoec -p
```

Display example:

```
ManagerHostA  
ManagerHostC
```

5. Cold-starting the agent host

For Windows

From **Control Panel**, in **Administrative Tools**, select **Service**.

From the Service window displayed, select the JP1/AJS3 service name to be started and execute the following: **Operation - Properties**.

From the **General** page in the *service-name* Property dialog box displayed, specify `-cold` as the start mode in **Start Parameters**.

After this, click **Start**.

For UNIX

Execute the `jajs_spmd -cold` command.

jpoagtjobshow

Format

```
jpoagtjobshow
  [-h host-name]
  [-m manager-host-name... | -all]
```

Description

Outputs the list of event jobs and custom event jobs currently being executed by the agent to the standard output file.

This command is executed by the agent execution host. Execution is possible irrespective of the situation of the job execution requesting manager, because only the information held by the agent is displayed. The list is displayed even if there is no match between the agent and the job execution requesting manager.

Execution privileges

In Windows: Administrators privilege

In UNIX: Superuser privilege

Arguments

-h *host-name*

Specifies the local host name or logical host name for the agent for which job information is to be displayed. You can specify a character string of 1 to 255 bytes.

By default, the system assumes the logical host name specified by the JP1_HOSTNAME environment variable. If the JP1_HOSTNAME environment variable is not specified, the system assumes the local host name.

This command will result in an error if the host executing the command does not have any definition for the agent host name.

-m *manager-host-name...* | -all

Specifies the manager host name for which you want to display job information among the managers that are sending a request for job execution to the agent specified in the -h option. Specify the name that is output by the hostname command if you are not operating DNS. Use the FQDN format if you are using DNS.

You can specify a character string of 1 to 255 bytes.

You can specify more than one manager host name. In that case, you must separate the manager host names by at least one space character.

Specify -all if you want to cover all manager hosts.

By default, the system assumes the manager host name which is the same as the agent host name. If the local manager does not exist, only the item names are displayed.

No command error occurs if the specified manager host does not have any job information. No command error occurs even if the specified manager host does not have any definition about the manager host name.

Notes

- An error will occur if you execute this command when JP1/AJS3 is not running.
- An error may occur if you execute this command when JP1/AJS3 is not completely started. Wait for a while and then retry.
- Always separate the option and its value by at least one space character.
- For an option requiring a value, the character string you specify next to the option is assumed as the value (Example: if you specify `-h -m`, the system assumes `-m` as the host name).
- You cannot execute more than one of these commands at the same time. After the first command has been executed, execute the second command.
- If you stop the JP1/AJS3 service during command execution, you might not receive any response from the command. In that case, you can cancel the command manually.

Return values

| | |
|---------------------|--------------|
| 0 | Normal end |
| Values other than 0 | Abnormal end |

Additional information

The job information is output for each manager. The order in which the agent has received requests for job execution determines the order of managers. For example, suppose that agent A has received requests for job execution from three managers: `ManagerA`, `ManagerB`, and `ManagerC` in that order. The job information is output in the order of `ManagerA`, `ManagerB`, and `ManagerC`.

Output example

Here is an example of file output, together with what the output means.

```
COMMAND START TIME=20XX/12/14 14:10:04

AGENT : agent1

MANAGER=manager1
Execution ID   Unit ID       Scheduler service name   Kind   Status   Request time   Watch kind
@A188         00000002932   AJSROOT1                evwjb  ready    20XX/12/14 10:04:21   E
@A189         00000002956   AJSROOT1                flwjb  not ready 20XX/12/14 10:04:40   E

MANAGER=manager2
Execution ID   Unit ID       Scheduler service name   Kind   Status   Request time   Watch kind
@A190         00000002982   AJSROOT1                lfwbj  ready    20XX/12/14 10:04:56   O

COMMAND END TIME=20XX/12/14 14:10:34
```

The following shows the meaning of the output.

COMMAND START TIME

Indicate the date and time at which the command starts its execution in the format of *YYYY/MM/DD HH:MM:SS*.

AGENT

Shows the agent host name (either the local host name or the logical host name).

MANAGER

Shows the manager host name requesting job execution.

Execution ID

Shows the execution ID.

Unit ID

Shows the unit ID.

Scheduler service name

Shows the scheduler service name.

Kind

Shows the type of job.

This command does not distinguish between an ordinary job and a recovery job. This means that even a recovery job is output in the form of an ordinary job.

- `evwjb`:
JP1 event reception monitoring job or JP1 event reception monitoring job for recovery
- `flwjb`:
File monitoring job or file for monitoring job for recovery
- `mlwjb`:
Email reception monitoring job or email reception monitoring job for recovery
- `mqwjb`:
Message queue reception monitoring job or message queue reception monitoring job for recovery
- `mswjb`:
MSMQ reception monitoring job or MSMQ reception monitoring job for recovery
- `lfwjb`:
Log file monitoring job or log file monitoring job for recovery
- `ntwjb`:
Windows event-log monitoring job or Windows event-log monitoring job for recovery
- `tmwjb`:
Execution interval control job or execution interval control job for recovery
- `cewjb`:
Custom event job or custom event job for recovery

Status

Shows the job status.

- `ready`:
Monitoring is in progress (The request from the agent has been sent to each monitoring process.)
- `not ready`:
Monitoring is not in progress.

Request time

Shows the time at which the agent received a request for job execution from the manager.

Watch kind

Shows the type of monitoring.

- E:
Event which has started monitoring through registration (event icon)
- O:
Event which has started monitoring through registration (start condition icon)
- A:
Event which has started monitoring through JP1/AJS3 restart or the like (event icon)
- H:
Event which has started monitoring through JP1/AJS3 restart or the like (start condition icon)

COMMAND END TIME

Indicates the date and time at which the command ends its execution in the format of *YYYY/MM/DD HH:MM:SS*.

Note that *YYYY/MM/DD HH:MM:SS* part means *calendar-year/month/day hours:minutes:seconds*.

jpomailprof (Windows only)

Format

```
jpomailprof
  {-add|-alt|-show|-del}
  [-e|-k|-v]
  [-h logical-host-name]
  [-n profile-name]
  [-m sender-email-address]
  [-x reply-email-address]
  [-s SMTP-server-name]
  [-p SMTP-server-communication-port]
  [-i account-name-for-authentication]
  [-j password-for-authentication]
  [-r POP3-server-name]
  [-t POP3-server-communication-port]
  [-f|-q]
  [-o IP-address-to-be-bound]
```

Format 1 (for creating a profile of an email account that does not require authentication)

```
jpomailprof
  -add
  [-e]
  [-h logical-host-name]
  -n profile-name
  -m sender-email-address
  [-x reply-email-address]
  -s SMTP-server-name
  [-p SMTP-server-communication-port]
  [-o IP-address-to-be-bound]
```

Format 2 (for creating a profile of an email account that uses POP before SMTP authentication)

```
jpomailprof
  -add
  -k
  [-h logical-host-name]
  -n profile-name
  -m sender-email-address
  [-x reply-email-address]
  -s SMTP-server-name
  [-p SMTP-server-communication-port]
  -i account-name-for-authentication
  -j password-for-authentication
  -r POP3-server-name
  [-t POP3-server-communication-port]
  [-o IP-address-to-be-bound]
```

Format 3 (for creating a profile of an email account that uses SMTP-AUTH authentication)

```
jpomailprof
  -add
  -v
```

```
[-h logical-host-name]
-n profile-name
-m sender-email-address
[-x reply-email-address]
-s SMTP-server-name
[-p SMTP-server-communication-port]
-i account-name-for-authentication
-j password-for-authentication
[-f|-q]
[-o IP-address-to-be-bound]
```

Format 4 (for changing the profile contents)

```
jpomailprof
-alt
[-e|-k|-v]
[-h logical-host-name]
-n profile-name
[-m sender-email-address]
[-x reply-email-address]
[-s SMTP-server-name]
[-p SMTP-server-communication-port]
[-i account-name-for-authentication]
[-j password-for-authentication]
[-r POP3-server-name]
[-t POP3-server-communication-port]
[-f|-q]
[-o IP-address-to-be-bound]
```

Format 5 (for listing registered profiles)

```
jpomailprof
-show
[-h logical-host-name]
```

Format 6 (for displaying the specified profile)

```
jpomailprof
-show
[-h logical-host-name]
-n profile-name
```

Format 7 (for deleting the specified profile)

```
jpomailprof
-del
[-h logical-host-name]
-n profile-name
```

Description

The `jpomailprof` command can create, change, reference, and delete a profile necessary for sending email messages without using Outlook.

Execution privileges

Administrators privilege

Arguments

-add

Specify this argument to create a profile.

A maximum of 16 profiles can be created.

If this option is specified, the `-n`, `-m`, and `-s` options must also be specified.

-alt

Specify this argument to change contents of a profile. Specify the name of the profile whose contents you want to change in the `-n` option, and use other options to specify information you want to change.

Only the specified options can be changed.

When an option (`-e`, `-k`, or `-v`) used to specify the authentication method is specified, other options must also be specified. For the combinations of options that need to be specified together, see the description of the `[-e | -k | -v]` option.

When this option is specified, the `-n` option cannot be omitted.

-show

Specify this argument to display a profile.

The profile specified by the `-n` option is displayed. If the `-n` option is omitted, all registered profile names are listed.

-del

Specify this argument to delete a profile. Specify the name of the profile you want to delete in the `-n` option.

When this option is specified, the `-n` option cannot be omitted.

[-e | -k | -v]

Specify the authentication method to be used when an email message is sent.

| Option | Authentication method | Required options | | | | | Description |
|-----------------|-----------------------|------------------|-----------------|-----------------|-----------------|------------------------|---|
| | | <code>-i</code> | <code>-j</code> | <code>-r</code> | <code>-t</code> | <code>{-f -q}</code> | |
| <code>-e</code> | N/A | N | N | N | N | N | No authentication processing is used. |
| <code>-k</code> | POP before SMTP | Y | Y | Y | C | N | POP before SMTP authentication is used. |
| <code>-v</code> | SMTP-AUTH | Y | Y | N | N | C | SMTP-AUTH authentication is used. |

Legend

Y: Must be specified.

C: Can be specified if needed. If omitted, the following values are assumed:

- `-t`: 110

- `{-f|-q}: -f`

N: Do not specify. If the option is specified, an error occurs.

If the `-add` option is specified, but this option is omitted, `-e` is assumed.

This option can be specified only when the `-add` or `-alt` option is specified.

-h *logical-host-name*

Specify the logical host name of the local host. On the host specified in this option, a profile can be created, changed, referenced, or deleted.

You can specify a character string of 1 to 255 bytes.

When executing the command on a physical host, do not specify this option and the `JP1_HOSTNAME` environment variable.

If the option is omitted, the logical host name specified for the `JP1_HOSTNAME` environment variable is assumed. If the `JP1_HOSTNAME` environment variable is not specified, the physical host name is assumed.

-n *profile-name*

Specify the profile name to be created, changed, referenced, or deleted.

You can specify a character string of 1 to 64 bytes. Japanese characters are also specifiable.

The specification of alphabetic characters is case insensitive.

If a profile name contains a space, enclose the profile name with double quotation marks (`"`). If quotation marks are not used, the command ends abnormally.

In addition, the following profile names cannot be specified:

- Names beginning with a space character
- Names consisting of a single period (`.`)
- Names containing any of the following characters:
`\, /, :, *, ?, ", <, >, or |`
- Any of the following:
`CON, PRN, AUX, CLOCK$, NUL, COM0, COM1, COM2, COM3, COM4, COM5, COM6, COM7, COM8, COM9, LPT0, LPT1, LPT2, LPT3, LPT4, LPT5, LPT6, LPT7, LPT8, LPT9`

For a physical host, depending on the installation location of JP1/AJS3, only a value 64 bytes or less can be specified as a profile name.

You must specify this option if you specify the `-add`, `-alt`, or `-del` option.

-m *sender-email-address*

Specify the sender email address.

The following characters can be used:

Alphanumeric characters, spaces, `!, #, $, %, &, ', *, +, -, /, =, ?, ^, _, ` , {, |, }, ~, ., (,), <, >, [,], :, ;, @, and ,`

The number of characters that can be specified for an email address is 1 to 255 (bytes).

Validity of the specified address is not checked.

You must specify this option if you specify the `-add` option.

`-x reply-email-address`

Specify this option if you want to use a reply email address that is different from the sender email address.

The following characters can be used:

Alphanumeric characters, spaces, !, #, \$, %, &, ', *, +, -, /, =, ?, ^, _, ` , {, |, }, ~, ., (,), <, >, [,], :, ;, @, and ,

The number of characters that can be specified for an email address is 1 to 255 (bytes).

Validity of the specified address is not checked.

If you specify the `-add` option but omit this option, the sender email address specified by using the `-m` option is assumed.

`-s SMTP-server-name`

Specify the name of the SMTP server to which you want email sent.

The following characters can be used:

Alphanumeric characters, ., -, _, and :

You can specify a character string of 1 to 255 bytes. More than one SMTP server name cannot be specified.

You must specify this option if you specify the `-add` option.

`-p SMTP-server-port-number`

Specify the port number of the communication port on the SMTP server.

You can specify a port number from 1 to 65535.

If you specify the `-add` option but omit this option, TCP number 25 is used.

`-i account-for-authentication`

Specify the account name for POP before SMTP authentication or SMTP-AUTH authentication.

You can specify a character string of 1 to 255 bytes.

You must specify this option if you specify the `-k` or `-v` option.

`-j password-for-authentication`

Specify the password of the authentication account for POP before SMTP authentication or SMTP-AUTH authentication.

The password specified for this option is scrambled, and then stored in the profile.

You can specify a character string of 1 to 127 bytes.

You must specify this option if you specify the `-k` or `-v` option.

-r POP3-server-name

Specify the name of the POP3 server to be used for POP before SMTP authentication.

The following characters can be used:

Alphanumeric characters, ., -, _, and :

You can specify a character string of 1 to 255 bytes.

More than one POP3 server name cannot be specified.

This option can be specified only when the -k option is specified.

-t POP3-server-port-number

Specify the port number of the communication port for the POP3 server used for POP before SMTP authentication.

You can specify a value from 1 to 65535 as the port number.

This option can be specified only when the -k option is specified.

If you specify the -k option but omit this option, TCP number 110 is used.

[-f | -q]

Specify the authentication method for SMTP-AUTH authentication.

| Option | Authentication method | Description |
|--------|-----------------------|---|
| -f | LOGIN | SMTP-AUTH LOGIN authentication is used. |
| -q | PLAIN | SMTP-AUTH PLAIN authentication is used. |

Note that SMTP-AUTH CRAM-MD5 authentication and SMTP-AUTH DIGEST-MD5 authentication cannot be used.

This option can be specified only when the -v option is specified.

If you specify the -v option but omit this option, -f is assumed.

-o IP-address-to-be-bound

Specify the sender IP address for communication.

If you specify 0, or specify the -add option but omit this option, the ANY binding method is used.

Both IP address formats (IPv4 and IPv6) can be specified. Specify the same IP address format as the name resolution result of the SMTP server name and the POP3 server name. Note that the name resolution result for the SMTP server name and the POP3 server name must be the same IP address format.

Notes

- A profile is stored in the folder shown below. To execute the command, the user must have Administrators privileges and be able to read, write, and delete this folder.

profile-storage-folder\sys\prf

Replace *profile-storage-folder* with the value set for the WaitInFileOutDir environment setting parameter of the [{JP1_DEFAULT | *logical-host-name* } \JP1AOMAGENT] definition key. For details about

the `WaitInFileOutDir` environment setting parameter, see 20.6.2(16) *WaitInFileOutDir (for agent processes)* in the *JP1/Automatic Job Management System 3 Configuration Guide*.

- If you execute this command multiple times, subsequent commands start execution after the current command finishes execution. If the processing of a command takes too much time, an error occurs, and the KAVT3847-E message is output.
- Note the following if you execute this command in a cluster environment:
 - Execute this command when you can access the shared disk.
 - When you create a profile, do so only in the primary node. It is not necessary to create a file in the secondary node.
- Do not execute this command while executing an email sending job. If you execute this command to add, update, or delete a profile while executing the email sending job, the following problems might occur:
 - It takes time for the command to end.
 - An error occurs during command execution, and the KAVT3847-E message is output.
 - An email sending job is delayed.
 - An email sending job ends abnormally.

Return values

| | |
|---------------------|--------------|
| 0 | Normal end |
| Values other than 0 | Abnormal end |

Example 1

The following example creates the `profile1` profile, which does not require authentication:

```
jpomailprof -add -n profile1 -m mail@mail.com -s testsmtp.com
```

Example 2

The following example creates the `profile2` profile, which uses POP before SMTP authentication:

```
jpomailprof -add -k -n profile2 -m mail@mail.com -s testsmtp.com -i id -j pass -r testpop3.com
```

Example 3

The following example creates the `profile3` profile, which uses SMTP-AUTH PLAIN authentication:

```
jpomailprof -add -v -n profile3 -m mail@mail.com -s testsmtp.com -i id -j pass -q
```

Example 4

The following example changes the SMTP server of the `profile1` profile:

```
jpomailprof -alt -n profile1 -s testsmtp2.com
```

Example 5

The following example lists the registered profiles:

```
jpomailprof -show
```

Example 6

The following example displays the specified profile1 profile:

```
jpomailprof -show -n profile1
```

Example 7

The following example deletes the specified profile1 profile:

```
jpomailprof -del -n profile1
```

Output example 1

The following example displays the specified profile1 profile:

```
jpomailprof -show -n profile1
SenderEmailAddress      xxx@xxx.xxx
ReplyEmailAddress      xxx@xxx.xxx
SMTPServer              smtptest.com:25
POP3Server              -
Authentication          -
USER ID                 -
Bind_IPAddress          192.168.0.2
```

The meaning of the output information is described below.

SenderEmailAddress

The sender email address is output.

ReplyEmailAddress

The reply email address is output.

SMTPServer

The SMTP server to be used is output in *SMTP-server-name : port-number-to-be-used* format.

POP3Server

The POP server to be used is output in *POP3-server-name : port-number-to-be-used* format. If the POP3 server is not used, - is output.

Authentication

The authentication that is used an email is sent is output in the following format.

| Authentication method | Character string to be output |
|--------------------------------|-------------------------------|
| N/A | - |
| POP before SMTP authentication | POP before SMTP |

| Authentication method | Character string to be output |
|--------------------------------|-------------------------------|
| SMTP-AUTH PLAIN authentication | SMTP-AUTH PLAIN |
| SMTP-AUTH LOGIN authentication | SMTP-AUTH LOGIN |

USER ID

The account name used for authentication when an email is sent is output. If authentication is not performed, – is output.

Bind_IPaddress

The IP address used by the sender is output. ANY is output for the ANY binding method.

Output example 2

The following example outputs all registered profile names:

```

jppmailprof -show
PATH = C:\Program Files\HITACHI\JP1AJS2\sys\prf\
[ProfileName]
test1
profile2
test3

```

The meaning of the output information is described below.

PATH

The path to the directory in which the profile is stored is output.

ProfileName

All registered profile names are output.

jpomanevreset

Format

```
jpomanevreset
  [-h logical-host-name]
  [-F service-name]
  [-a execution-host-name|-all]
  [-s]
  [-e]
  [-dh manager-host-name -a execution-host-name]
```

Description

Deletes the information that is to be held by the event action control manager. The command also deletes information on the execution host after communicating with the execution host specified in the `-a` option.

When a large number of events related to start conditions occur, event action control is in a state of high load, with the result that a slowdown or similar problem may occur in the entire system. However, you can execute this command to return the system to normal operation from the next JP1/AJS3 startup. If the system has several agents, you should use the `jpomanevshow` command in advance to identify the agent that has caused a large number of events.

In addition, if you run the command with the `-dh` option specified in cases such as the following, the command communicates with the execution host specified in the `-a` option and deletes the information on the execution host side:

- In an environment where a hardware copying and mirroring function is used to enable disaster recovery, JP1/AJS3 at the remote site is started by disaster recovery start.
- In an environment that uses an external database, JP1/AJS3 is started by disaster recovery start after recovery.
- In an environment that uses the backup enhancement function, JP1/AJS3 is started by disaster recovery start after recovery.

In the standard configuration, this command can be executed only when the JP1/AJS3 host service is running and the target JP1/AJS3 scheduler service is not running. If you execute the command when the target JP1/AJS3 scheduler service is running or the overall JP1/AJS3 service has stopped, the command results in an error. However, if you specify the `-dh` option, provided that the JP1/AJS3 service is running, you can execute this command regardless of the status of the JP1/AJS3 scheduler service.

For details about how to stop the scheduler service, see *jajs_spm�_stop* in *3. Commands Used for Normal Operations*.

Execution privileges

In Windows: Administrators privileges

In UNIX: Superuser privileges

Arguments

`-h` *logical-host-name*

Specifies the name of the logical host responsible for event reset when you are working with a cluster system.

You can specify a string of 1 to 255 bytes.

If you omit this option, the logical host name specified in environment variable `JP1_HOSTNAME` is assumed. If the environment variable `JP1_HOSTNAME` is not specified, the local host name is assumed.

-F service-name

Specify the name of the scheduler service for which you want to delete information.

You can specify a character string of 1 to 30 bytes.

If you specify the `-a` option together with this option, you can limit the jobs for which you want to delete information to the event jobs, custom event jobs and jobnets with start conditions executed on the host specified in the `-a` option. If you do not specify the `-a` option, the command deletes the information about all jobs executed from the scheduler service specified in the `-F` option.

If you omit this option, the system assumes the default scheduler service name.

-a execution-host-name | -all

When you perform an event reset, you can delete only information about a specific target host by specifying the host name in the `-a` option. The execution host name you specify in this option is the execution host name specified in the `-s` option of the `ajsagtadd` command. For example, if an execution host name in FQDN format is specified in the `-s` option of the `ajsagtadd` command, you need to specify in the `-a` option the execution host name in FQDN format.

You can use the `ajsagtshow` command to check the execution host name for the execution agent name.

Example: `ajsagtshow -l`

For details about the `ajsagtadd` command, see *ajsagtadd* in [3. Commands Used for Normal Operations](#). For details about the `ajsagtshow` command, see *ajsagtshow* in [3. Commands Used for Normal Operations](#).

You can specify a character string of 1 to 255 bytes.

If you do not want to limit the target hosts on which you want to delete information about jobs executed from the scheduler service specified in the `-F` option, specify `-all`.

If you omit this option, the system assumes the execution host associated with the default execution agent.

-s

Deletes only the information on the manager without communicating with the execution host specified in the `-a` option.

Specify this option if any of the following conditions is met. If you omit this option under the following conditions, it may take time before the command is terminated.

- When the JP1/AJS3 service on the execution host is cold-started
- When communication between the manager and the execution host cannot be performed properly because of communication failure

If you omit this option, the information on the execution host is also deleted after communicating with the execution host specified in the `-a` option.

-e

Deletes only unprocessed data while continuing to execute the event job, custom event job and start conditions. Because the monitoring state on the execution host is terminated once before re-execution, there is a time difference from when the JP1/AJS3 service is started until actual monitoring starts on the execution host.

If you omit this option, the event job, custom event job and start conditions being executed are terminated.

When using this option to execute the command, you need to perform the steps shown in the table below:

Table 3–34: What you need to do before and after starting JP1/AJS3

| Timing | Action |
|--------------------------|--|
| Before starting JP1/AJS3 | On the execution host, remove the cause of the problem. |
| After starting JP1/AJS3 | On JP1/AJS3 - View, check the state of the job and re-execute the command, as necessary. |

-dh *manager-host-name* -a *execution-host-name*

Specify a manager host name in cases such as the following. If you do not specify the manager host name, the JP1/AJS3 service might take a long time to start on the agent.

- In an environment where a hardware copying and mirroring function is used to enable disaster recovery, JP1/AJS3 at the remote site is started by disaster recovery start.
- In an environment that uses an external database, JP1/AJS3 is started by disaster recovery start after recovery.
- In an environment that uses the backup enhancement function, JP1/AJS3 is started by disaster recovery start after recovery.

You can specify a character string of 1 to 255 bytes.

Specify this option together with the `-a` option. If you omit the `-a` option, the message KAVT8347-E is output and the command terminates abnormally. In the `-a` option, specify an execution host that the manager can communicate with. If you specify a host that is inaccessible or not running a JP1/AJS3 service, after a long delay the command outputs message KAVT8343-W before ending normally. This message indicates that the command was unable to delete information about the execution host specified in the `-a` option. In this case, if the service is stopped on the execution host specified in the `-a` option, start the service and then execute the command again. If the host is inaccessible, execute the command again after ensuring that the host can be communicated with.

You cannot specify this option with the `-all` option, `-s` option, or `-e` option. If you do, the message KAVT8307-E is output and the command terminates abnormally.

If multiple scheduler services are executing event jobs or custom event jobs on the execution host, execute the `jpomanevreset` command for each scheduler service.

Notes

- Always separate an option and its value by at least one space character.
- You cannot execute several instances of this command at the same time. Wait for one command to be completed before you move on to another command.
- If the target host specified in the `-a` option has been defined as the target host for multiple execution agents, information about these execution agents is also deleted.

- The command does not check whether the target host specified in the `-a` option has been registered as the target host for the execution agent in agent management information. Therefore, if JP1/AJS3 has not been installed on the specified target host, it could take time before the command terminates.
- If you execute the command when the folder to be used for storing information about the event action control manager, which is used by the event action control manager, does not exist, the system operates as if there were no data. The command is terminated normally. For details about the folder for storing information about the event control action manager, see *A.1 JP1/AJS3 - Manager files and directories* in the manual *JP1/Automatic Job Management System 3 Troubleshooting*.
- Note that the command will terminate normally even if you fail to delete the file or send data to the execution host. If the KAVT8342-E A file access error occurred. *(file-name) (maintenance-information)* or KAVT8343-W An attempt to communicate with the agent has failed. *(agent-host-name) (maintenance-information)* message is output in the standard error output file, you must manually delete the file according to the specified procedure.
- If you fail to delete files, the KAVT8342-E A file access error occurred. *(file-name) (maintenance-information)* message for each of the unsuccessful files is output to the standard error output file. If you fail to delete a large number of files, a large number of error messages are output accordingly. This implies that you cannot view all the messages. For this reason, you should redirect the standard error output file when executing this command.

Example:

```
jpomanevreset 2> file-name
```

- If the KAVT8343-W An attempt to communicate with the agent has failed. *(agent-host-name) (maintenance-information)* message is output, the information about the agent involving the error is not deleted. As necessary, therefore, you should cold-start the JP1/AJS3 service on the execution host.
- If the `-all` option is specified, the command reports that the specified scheduler service has been cold-started to the target hosts on which the status of event jobs, custom event jobs and jobnets with start conditions is *Now running*. In addition, the command also performs the same report to the target hosts for which unreported information exists. If the `-a` option is specified, the command reports that the specified scheduler service has been cold-started to the specified target host even if the status of event jobs, custom event jobs and jobnets with start conditions is not *Nor running*.
- If an error such as a network error occurs while data is being sent to the target host, the behavior of the command is as follows:
 - When the agent host cannot be connected (a connection attempt times out)
The command does not retry sending of data.
 - When another network error occurs
The command retries to connect (up to two attempts) at 10-second intervals.

For this reason, if the target host or the JP1/AJS3 service on the target host has stopped, it could take time before the command terminates. If the target host name cannot be resolved into the IP address, the command also retries acquisition of the IP address three times at one-second intervals.

- You execute this command in the same environment as that of JP1/AJS3 operation. For example, suppose that you changed DNSEstablish after a JP1/AJS3 stop. Executing this command changes the host name used when communicating with the execution host, so that you cannot identify which manager information needs to be deleted on the execution host. This may cause a problem; for example, the information on the execution host will not be deleted, as expected.
- If there are many files under the folder used for storing information about the event control action manager, it will take time before the command is completed because of the presence of many files that are to be searched for and deleted.

- If you specify the local host name in the `-h` option, the system will operate by assuming that a physical host is specified.
- If you execute the command after specifying the `-e` option, the system continues to monitor event jobs, custom event jobs and start conditions but deletes the event information and event start information generated before the event reset. For this reason, you may see *Now running* for the status of a job in which an event occurred before an event reset or *Now queuing* for the state of a job in which monitoring has already started. If this occurs, for *Now running* jobs, you must re-generate events meeting the conditions. For *Now queuing* jobs, meanwhile, you should either use them as they are or terminate them and then re-register them.
- On the target host side, only the information managed by the target host is deleted. Files remaining as trash are not deleted. If you want to delete files left on the target host as trash, cold-start the JP1/AJS3 service on the target host side.
- If you execute the command without specifying the `-e` option, monitoring of event jobs, custom event jobs and start conditions ends. If monitoring of these is necessary, perform registration again. You can ignore the KAVS1400-E and KAVS0265-E messages output to the integrated trace log because these messages pertain to termination of monitoring of event jobs, custom event jobs and start conditions.

- If you specify the `-dh` option, the command terminates all event jobs and custom event jobs that are running in the range from the manager host specified in the `-dh` option to the execution host specified in the `-a` option. Therefore, use the `-dh` option only when any of the cases shown in the description of the option applies.

If you inadvertently specify the `-dh` option when none of those cases applies, perform the following procedure: First, from the manager host specified in the `-dh` option, forcibly terminate all event jobs and custom event jobs that are running on the execution hosts specified in the `-a` option. Then, register the event jobs and the custom event jobs for execution again.

- If the default scheduler service name assumed when the `-F` option is omitted is not registered, the command outputs message KAVT8351-E to standard error output and terminates abnormally. Make sure that the default scheduler service name is registered on the command execution host, and then execute the command again.

You can reference the `-h` option in the command line to identify the host where the command will be executed.

Return values

| | |
|-----|---|
| 0 | Normal end. |
| 1 | There is an argument improperly specified. |
| 2 | Initialization failed. There is an error in the definitions or environment settings on the logical host. |
| 3 | Privileges not sufficient for task requested. |
| 4 | The scheduler service specified in the <code>-F</code> option is running. |
| 5 | The same command is being used simultaneously. |
| 100 | A file access error occurred. |
| 101 | Memory shortage occurred. |
| 255 | A system error occurred. |

Additional information

The status of JP1/AJS3 - View displayed when JP1/AJS3 is normally started is different from that displayed when JP1/AJS3 is started after you use the `jpomanevreset` command to recover the status of the event action control manager. The state of JP1/AJS3 - View is also different depending on whether you specify the `-e` option in the

jpomanevreset command: that is, whether the event jobs, custom event jobs and start conditions are to be continued. These different statuses are compared and summarized below:

- When you hot-start JP1/AJS3 (-hot)

| Target | Status | | | | | | |
|---|-----------------------------------|----------------------------------|-----------------------------------|---|-----------------------------------|----------------------------------|-----------------------------------|
| | Status before JP1/AJS3 is stopped | Normal state | | After executing the jpomanevreset command | | | |
| | | Being executed on the local host | Being executed on the remote host | Specifying -e | | Not specifying -e | |
| | | | | Being executed on the local host | Being executed on the remote host | Being executed on the local host | Being executed on the remote host |
| Event job and custom event job (in jobnet) | Now running | Ended abnormally #1, #2 | Now running #2 | Ended abnormally/Unknown end status | Now running/Unknown end status | Unknown end status | |
| | Wait for prev. to end | Wait for prev. to end #3 | | Wait for prev. to end #3 | | | |
| | Being held | Being held #3 | | Being held #3 | | | |
| | Now queuing | Now running/Ended abnormally | Now running | Ended abnormally/Unknown end status | Now running/Unknown end status | Unknown end status | |
| | Other statuses | No change | | No change | | | |
| Start condition | Now monitoring | Now monitoring | | Now monitoring | | Monitor terminated | |
| | Other statuses | No change | | No change | | | |
| Event job and custom event job in start condition | Now running | Now running | | Now running/Unknown end status | | Unknown end status | |
| | Now queuing | Now queuing | | Now queuing/Unknown end status | | | |
| | Other statuses | No change | | No change | | | |

#1

The Now running status occurs when the system is restarted after a system down.

#2

The Unknown end status may occur depending on the timing of the termination processing.

#3

If the Not executed + Ended status occurs when the preceding unit is handled as an abnormal end.

- When you warm-start JP1/AJS3 (-warm)

| Target | Status | | | | | | |
|---|-----------------------------------|----------------------------------|-----------------------------------|---|-----------------------------------|----------------------------------|-----------------------------------|
| | Status before JP1/AJS3 is stopped | Normal status | | After executing the jpomanevreset command | | | |
| | | Being executed on the local host | Being executed on the remote host | Specifying -e | | Not specifying -e | |
| | | | | Being executed on the local host | Being executed on the remote host | Being executed on the local host | Being executed on the remote host |
| Event job and custom event job (in jobnet) | Now running | Unknown end status | | Unknown end status | | | |
| | Wait for prev. to end | Not executed + Ended | | Not executed + Ended | | | |
| | Being held | Not executed + Ended | | Not executed + Ended | | | |
| | Now queuing | Unknown end status | | Unknown end status | | | |
| | Other statuses | No change | | No change | | | |
| Start condition | Now monitoring | Now monitoring | | Now monitoring/ Monitor terminated | | Monitor terminated | |
| | Other statuses | No change | | No change | | | |
| Event job and custom event job in start condition | Now running | Now running | | Now running/Unknown end status | | Unknown end status | |
| | Now queuing | Now queuing | | Now queuing/Unknown end status | | | |
| | Other statuses | No change | | No change | | | |

- When you cold-start JP1/AJS3 (-cold)

| Target | Status | | | | | | |
|---|-----------------------------------|----------------------------------|-----------------------------------|---|-----------------------------------|----------------------------------|-----------------------------------|
| | Status before JP1/AJS3 is stopped | Normal state | | After executing the jpomanevreset command | | | |
| | | Being executed on the local host | Being executed on the remote host | Specifying -e | | Not specifying -e | |
| | | | | Being executed on the local host | Being executed on the remote host | Being executed on the local host | Being executed on the remote host |
| Event job and custom event job (in jobnet) | Now running | Not registered | | Not registered | | | |
| | Wait for prev. to end | | | | | | |
| | Being held | | | | | | |
| | Now queuing | | | | | | |
| | Other statuses | | | | | | |
| Start condition | Now monitoring | Not registered | | Not registered | | | |
| | Other statuses | | | | | | |
| Event job and custom event job in start condition | Now running | Not registered | | Not registered | | | |
| | Now queuing | | | | | | |
| | Other statuses | | | | | | |

- If the startup mode is not specified when JP1/AJS3 is started

The status of each item when the startup mode of the scheduler service is used is the same as that of the corresponding item shown above.

Example 1

For an example of deleting the information held by the event action control manager, see *Example* in *jpomanevshow* in *3. Commands Used for Normal Operations*.

Example 2

The following command deletes information about the manager host *MAINHOST* held by execution agent *API* in an environment where operation has been switched to a remote site using the disk copy and mirroring functionality of the hardware.

```
jpomanevreset -h LogicalHost -F AJSROOT2 -dh MAINHOST -a API
```

jpomanevshow

Format

```
jpomanevshow  
  [-h logical-host-name]  
  [-F service-name]
```

Description

Analyzes the internal log of the event action control manager and displays the execution hosts that often send data to the manager and information about start conditional jobnet. You use this command when you want to identify a job that has caused a large number of events related to start conditions, as well as the agent that is to be specified in the arguments of the `jpomanevreset` command. (See [Example](#).)

The targets of analysis are the logs that have been output within the last 24 hours. If there are wrapped logs, then only the remaining logs are to be analyzed. The target of analysis also covers only the logs related to start conditions, not covering the event jobs that is defined in the jobnets.

In the result of analysis, five start conditions are displayed, starting with those with the highest level of data sending. For each of the start conditions, the information that can identify the particular start condition and the number of logs during a certain period of time are displayed.

Before you can execute this command, make sure that the JP1/AJS3 host service is running.

Execution privileges

In Windows: Administrators privileges

In UNIX: Superuser privileges

Arguments

-h *logical-host-name*

Specifies the name of the logical host that displays information when you are operating with a cluster system.

You can specify a string of 1 to 255 bytes.

If you omit this option, the logical host name specified in the `JP1_HOSTNAME` environment variable is assumed. If the `JP1_HOSTNAME` environment variable has not been set, the local host name is assumed.

-F *service-name*

Specify the name of the scheduler service for which you want to analyze the internal log.

You can specify a character string of 1 to 30 bytes.

If you omit this option, the system assumes the default scheduler service name.

Notes

- Do not execute this command while JP1/AJS3 is starting.
- Always separate an option and its value by at least one space character.

- You cannot execute several instances of this command at the same time. Wait for one command to be completed before you move on to another command.
- If you execute the command when the folder used for storing the internal log of the event action control manager does not exist, the system operates as if there were no data, and the command is terminated normally. For details about the folder used or storing the internal log of the event action control manager, see *1.2.5 List of log files and directories* in the manual *JP1/Automatic Job Management System 3 Troubleshooting*.
- If you specify the local host name in the `-h` option, the system will operate by assuming that a physical host is specified.
- On a Windows machine, before you execute this command, make sure that you open the Command Prompt window as an administrator. If the UAC function is disabled, you do not need to open the Command Prompt window as an administrator.
- If the default scheduler service name assumed when the `-F` option is omitted is not registered, the command outputs message KAVT8351-E to standard error output and terminates abnormally. Make sure that the default scheduler service name is registered on the command execution host, and then execute the command again.
You can reference the `-h` option in the command line to identify the host where the command will be executed.

Return values

| | |
|-----|---|
| 0 | Normal end. |
| 1 | There are arguments improperly specified. |
| 2 | Initialization failed. The definition of the logical host name is incorrect. Alternatively, there is an error in the environment settings. |
| 3 | Privileges not sufficient for task requested |
| 5 | The same command is being used simultaneously. |
| 100 | A file access error occurred. |
| 101 | Memory shortage occurred. |
| 255 | A system error occurred. |

Output example

The following is an example of output obtained when you execute the command on the manager host:

```
Time for analysis=20XX/06/01 02:30:00 - 20XX/06/02 02:30:00

Agent=agent1
Scheduler service=AJSROOT1
Unit ID=2133
Execution ID=2000 (ID:@A2000)
Total count=233
Target time                Count
20XX/06/01 22:00:00-22:59:59      1
20XX/06/01 23:00:00-23:59:59      1
20XX/06/02 00:00:00-00:59:59      1
20XX/06/02 01:00:00-01:59:59      30
20XX/06/02 02:00:00-02:30:00     200

Agent=agent1
Scheduler service=AJSROOT1
Unit ID=2134
```

```

Execution ID=2000 (ID:@A2000)
Total count=1
Target time                Count
20XX/06/01 17:00:00-17:59:59    1

```

The content of each item output can be interpreted as follows:

Time for analysis

Indicates the time required for analysis. The time displayed here shows the time measured on the internal log and it may be different from the system time.

Agent

Indicates the name of the execution host sending data.

Scheduler service

Indicates the scheduler service name in which start conditions are defined.

Unit ID

Indicates the unit ID of the event job defined in the start conditions.

Execution ID

Indicates the execution ID for start conditions. The execution ID corresponds to the "Being executed" generation displayed on the Daily Schedule window or the Monthly Schedule window.

What is shown in parentheses corresponds to what is displayed on JP1/AJS3 - View.

Total count

Indicates the total number of entries that were stored in the internal log and that pertain to start conditions.

Target time

Indicates the target duration at which to display the number of logs per unit time. If no logs occur during the target duration, the target duration itself will not be output.

Count

Indicates the total number of log entries that were present during the target time and that pertain to start conditions.

Example

Suppose that there has been a rapid increase in the number of events that monitor start conditions. The entire system operating JP1/AJS3 will suffer from high loads because of frequent communication between the manager and the agent and frequent input/output operations of files for storing data temporarily. This makes the operator's action ineffective, thus leading to a major delay in the processing of other programs. In this case, you use the `jpomanevshow` command to identify the job and event responsible for the large number of events related to start conditions. You can return to normal operation if you eliminate the cause of the large number of monitoring conditions for the particular job and use the `jpomanevreset` command to remove the large number of event data items from the particular agent.

```

# ./jpomanevshow
Time for analysis=20XX/06/01 02:30:00 - 20XX/06/02 02:30:00

Agent=agent1
Scheduler service=AJSROOT1
Unit ID=2133
Execution ID=2000(ID:@A2000)
Total count=1123
Target time      Count
20XX/06/01 22:00:00-22:59:59    1
20XX/06/01 23:00:00-23:59:59    1
20XX/06/02 00:00:00-00:59:59    1
20XX/06/02 01:00:00-01:59:59   603
20XX/06/02 02:00:00-02:30:00   517

Agent=agent1
Scheduler service=AJSROOT1
Unit ID=2134
Execution ID=2000(ID:@A2000)
Total count=1
Target time      Count
20XX/06/01 17:00:00-17:59:59    1

# ./ajsname -l 2133
/jobnet1/.CONDITION/file-monitoring

# ./jpomanevreset -a agent1

```

Because more than 1,000 events occurred, the following are identified:
Job: 2133
Agent: agent1

The ajsname command is used to identify the particular job name.

The jpomanevreset command is used to specify the particular agent.

For details about the above procedures, see *2.5 Troubleshooting problems if processing of a jobnet with a start condition is delayed* in the manual *JP1/Automatic Job Management System 3 Troubleshooting*.

jpomanjobshow

Format

```
jpomanjobshow
  [-h host-name]
  [-F service-name]
  [-a execution-agent-name...|-all]
```

Description

Outputs a list of the event jobs and the custom event jobs currently being executed in the manager to the standard output file.

This command is executed on a host for executing a manager. Regardless of the situation of the job execution agent, you can execute this command because only the information maintained by the manager is displayed. The list is displayed even if versions of the manager and the job execution agent do not match.

Execution privileges

In Windows: Administrators privilege

In UNIX: Superuser privilege

Arguments

-h *host-name*

Specify the local host name or logical host name for the manager which is to display job information. You can specify a character string of 1 to 255 bytes.

By default, the system assumes the logical host name specified by the JP1_HOSTNAME environment variable. Without the JP1_HOSTNAME environment variable, however, the system assumes the local host name.

This command results in an error if the command executing host does not have any no definition about the specified manager host name.

-F *service-name*

Specify the name of the scheduler service for which you want to display job information.

You can specify a character string of 1 to 30 bytes.

If you omit this option, the system assumes the default scheduler service name.

-a *execution-agent-name...|-all*

Of the execution agents on which the manager specified in the -h option requested to execute jobs, you can display job information for only a specific execution agent. To do this, specify the execution agent name in the -a option.

You can specify a character string of 1 to 255 bytes.

You can specify more than one execution agent name. In that case, the execution agent names must always be separated by at least one space character.

Specify `-all` if you want to cover all execution agents.

If this option is omitted, the default execution agent is assumed.

If the specified execution agent has no job information or does not even exist, the command does not result in an error.

Notes

- Before you execute this command, make sure that the JP1/AJS3 service is running.
- Do not execute this command while JP1/AJS3 is starting.
- Always separate an option and its value by at least one space character.
- For options that require a value to be specified, the string specified next to the option is assumed to be a value. For example, if you enter `-h -a`, `-a` is assumed as the logical host name specified for the `-h` option.
- You cannot execute more than one these commands at the same time. After the first command has been executed, execute the second command.
- If the default scheduler service name assumed when the `-F` option is omitted is not registered, the command outputs message KAVT8351-E to standard error output and terminates abnormally. Make sure that the default scheduler service name is registered on the command execution host, and then execute the command again.

You can reference the `-h` option in the command line to identify the host where the command will be executed.

Return values

| | |
|---------------------|--------------|
| 0 | Normal end |
| Values other than 0 | Abnormal end |

Additional information

No error occurs even if you execute this command when JP1/AJS3 scheduler service is not running. If there is a job scheduled to be executed next, the information about the job is output.

Output example

Here is an example of file output, together with what the output means.

```

COMMAND START TIME=20XX/12/14 14:10:04

MANAGER : manager1

AJSPATH=/TEST/JobNet1/
JOBNAME=JOB1
AGENT=agent1
Execution ID      Unit ID      Scheduler service name      Kind  Information
@A188            00000002932  AJSROOT1                   evwjb

AJSPATH=/TEST/JobNet1/
JOBNAME=JOB2
AGENT=agent1
Execution ID      Unit ID      Scheduler service name      Kind  Information
@A189            00000002956  AJSROOT1                   flwjb

AJSPATH=/TEST/JobNet2/
JOBNAME=JOB1
AGENT=agent2
Execution ID      Unit ID      Scheduler service name      Kind  Information
@A190            00000002982  AJSROOT1                   lfwb  unreported

COMMAND END TIME=20XX/12/14 14:10:34

```

The following shows the meaning of the output.

COMMAND START TIME

Indicate the date and time at which the command starts its execution in the format of *YYYY/MM/DD HH:MM:SS*.

MANAGER

Shows the manager host name (either the local host name or the logical host name).

AJSPATH

Shows the jobnet name in the */root-jobnet-name/jobnet-name/* format.

JOBNAME

Shows the job names in the jobnet.

AGENT

Shows the execution agent name.

This item is the name of the execution agent on which job execution is requested.

Execution ID

Shows the execution ID.

Unit ID

Shows the unit ID.

Scheduler service name

Shows the scheduler service name.

Kind

Shows the types of jobs.

- evwjb: JP1 event reception monitoring job
- revwjb: JP1 event reception monitoring job for recovery
- flwjb: File monitoring job
- rflwjb: File monitoring job for recovery

- `mlwjb`: Email reception monitoring job
- `rmlwjb`: Email reception monitoring job for recovery
- `mqwjb`: Message queue reception monitoring job
- `rmqwjb`: Message queue reception monitoring job for recovery
- `mswjb`: MSMQ reception monitoring job
- `rmswjb`: MSMQ reception monitoring job for recovery
- `lfwjb`: Log file monitoring job
- `rlfwjb`: Log file monitoring job for recovery
- `ntwjb`: Windows event-log monitoring job
- `rntwjb`: Windows event-log monitoring job for recovery
- `tmwjb`: Execution interval control job
- `rtmwjb`: Execution interval control job for recovery
- `cewjb`: Custom event job
- `rcewjb`: Custom event job for recovery

Information

Shows job information.

- **unreported:**
The execution agent has not received the request for starting job execution because, for example, the execution agent is not running (it is registered with the unreported information file).
- **(No indication)**
There is no information to be reported (nothing is registered in the unreported information file).
In this case, any of the following statuses could exist:
 - Nothing is contained in the unreported information file because nothing was processed by the manager.
 - An error occurred while the unreported information file was being accessed.
 - A request has arrived at the execution agent correctly.

You can use the `jpoagtjobshow` command to see whether the job has been actually executed in the agent.

COMMAND END TIME

Indicates the date and time at which the command ends its execution in the format of `YYYY/MM/DD HH:MM:SS`.

The `YYYY/MM/DD HH:MM:SS` part means *calendar-year/month/day hours:minutes:seconds*.

jpqdbcond

Format

```
jpqdbcond
  [-h logical-host-name]
  [[-m] |
   [[-x] [-k]
    [-d directory-name][-p {output-destination}]]|
  [[{-l|-L} [-a] [[-i {output-destination}]|
   [-t {output-destination,unused-area-size-threshold} [-v]]]]
   |[-t {output-destination,unused-area-size-threshold} [-v]]]]
```

Description

1. Compresses unused areas and reorganizes files if the ratio of unused areas is high for the ISAM files that the job execution environment uses.
2. Outputs the ratio of unused areas, data file fragmentation ratio, and unused size for the ISAM files used in the job execution environment, to the standard output file.
You can display the ratio of unused areas for the ISAM files even while the job execution environment is using the ISAM files.
3. Outputs the following information for the ISAM files that the job execution environment uses, to the specified destination as a message:
 - Information about reorganization (start and end date/time, statistics)
 - Unused area size
 - Whether the unused area size has reached the thresholdYou can specify one or more of the following message destinations:
 - Standard error output
 - Windows event log or Syslog
 - JP1 event
4. Checks whether the size of unused areas for the ISAM files that the job execution environment uses has reached the threshold and sets the result in the return value of the command.
5. Converts the format of the ISAM file.

Execution privileges

In Windows: Administrators privilege

In UNIX: Superuser privilege

Arguments

-h *logical-host-name*

Specify the target logical host name.

You can specify a character string of 1 to 255 bytes.

By default, the system assumes the logical host name specified by the `JP1_HOSTNAME` environment variable. If the `JP1_HOSTNAME` environment variable is not specified, the system assumes the local host name.

-m

Outputs the number of ISAM lock table entries and the ISAM file format (whether the key reuse functionality is enabled) for the job execution environment database.

You cannot specify this option with any option other than `-h`.

-x

Completely reorganizes the data and key files for the ISAM files used in the job execution environment.

-k

Converts all ISAM files that constitute the job execution environment to the format enabling the key reuse functionality and completely reorganizes the data and key files.

-d *directory-name*

Specify the directory name for the work file used for key sorting, if you reorganize the ISAM files that the job execution environment uses.

For an explanation of the system action when you omit this option, see the description of the `Jiscond` command in the *JP1/Base User's Guide*.

-p {*output-destination*}

Outputs a message when the command starts and ends the reorganization of the ISAM files that the job execution environment uses.

You must specify this option with the `-x` option.

- *output-destination*

Specifies one of the following message output destinations.

You can specify a single destination or a combination of two or more destinations.

e: Standard error output

s: Windows event log or Syslog

j: JP1 event

The following shows example message output when this option is specified:

Example 1: When reorganization is started

```
KAVU5980-I Database condensing of the job execution environment started. 2  
0XX/10/01 01:05:40
```

Example 2: When reorganization is ended normally

```
KAVU5981-I Database condensing of the job execution environment ended norm  
ally. 20XX/10/01 01:05:40 - 20XX/10/01 01:20:20 (00:14:40)
```

The start date/time, end date/time, elapsed time, unused area size before reorganization, and unused area size after reorganization are also output.

Example 3: When reorganization is ended abnormally

```
KAVS5982-E Database condensing of the job execution environment ended abno  
rmally. 20XX/10/01 01:05:40 - 20XX/10/01 01:20:20 (00:14:40)
```

{-l|-L}

Displays the ratio of unused areas for the ISAM files that the job execution environment uses.

You can obtain more detailed information about the ISAM files by specifying this option with the `-a` option.

- `-l`

Exclusively uses the ISAM files to obtain information.

Because this option exclusively uses the files, it provides more accurate information than the `-L` option. It, however, causes an error if another process is using the ISAM files.

- `-L`

Obtains information without exclusively using the ISAM files.

Because this option does not exclusively use the files, it can obtain information even while the job execution environment is using the ISAM files. If another process is simultaneously updating the ISAM files, however, the command fails to obtain accurate information for any updates performed just when it obtains information.

-a

Outputs detailed information about the ISAM files that the job execution environment uses.

If this option is specified with the `-l` or `-L` option, the command outputs the data file fragmentation ratio and unused area size as well as the ratio of unused areas.

-i {output-destination}

Outputs a message indicating the unused area size for the ISAM files that the job execution environment uses.

- *output-destination*

Specifies one of the following message output destinations.

You can specify a single destination or a combination of two or more destinations.

e: Standard error output

s: Windows event log or Syslog

j: JP1 event

The following shows example message output when this option is specified:

Example

```
KAVU5983-I The ISAM unused area size on job execution environment is 99 M
B.
```

-t {output-destination} , unused-area-size-threshold

Outputs a message if the unused area size for the ISAM files that the job execution environment uses has reached the specified threshold.

You can use this option to schedule the execution of the `jpqdbcond` command as a JP1/AJS3 job when the system is not very busy (e.g., not executing a large number of jobs), so that the command periodically checks the status of the ISAM files and outputs a warning message as required.

- *output-destination*

Specifies one of the following message output destinations.

You can specify a single destination or a combination of two or more destinations.

e: Standard error output

s: Windows event log or Syslog

j: JP1 event

- *unused-area-size-threshold*

Specifies a threshold for the unused area size for the ISAM files.

You can specify a value within the range from 1 to 1024 (in MB; 1 MB = 1,024 * 1,024 bytes).

The following shows an example message output when this option is specified:

Example:

```
KAVU5984-W The ISAM unused area size of the job execution environment is 101 MB, which exceeds the 100 MB threshold value.
```

-v

Sets the return value (process return code) of the command to indicate whether the ratio of unused areas has reached the specified value.

You must specify this option with the `-t` option.

The following shows the return values of the `jpgdbcond` command, which depend on whether this option is specified:

- Return value when the `-v` option is not specified

| | |
|---------------------|--------------|
| 0 | Normal end |
| Values other than 0 | Abnormal end |

- Return value when the `-v` option is specified

| | |
|----------------|---|
| 0 | The unused area size has not reached the threshold. |
| 1 | The unused area size has reached or exceeded the threshold. |
| 100 or greater | Abnormal end |

Notes

- Perform reorganization after you have backed up the relevant files. The `jpgdbcond` command uses the directory specified in the `-d` option as a work directory. The drive or partition that contains the directory must have at least twice as much free space as the largest ISAM key file in the job execution environment you want to reorganize. In addition, the drive or partition that contains the job execution environment database directory must have at least as much free space as the largest ISAM key file in the job execution environment you want to reorganize. If you do not specify the `-d` option, the command uses the OS standard work directory. See the description of the `Jiscond` command in the *JP1/Base User's Guide*.
- If you specify none of the `-x`, `-t`, `-l`, `-L`, `-k`, and `-m` options, the `-x` option is assumed.
- If you specify the `-x` or `-k` option for this command, you must back up the ISAM files before executing the command (before reorganizing the ISAM files).
- If you specify the `-x`, `-l`, or `-k` option for this command, you must execute the command with the ISAM files closed (to close the ISAM files, stop JP1/AJS3). When the ISAM files are open, executing the command will result in an error.

- If you specify the `-L` option for this command, you can also obtain information about any ISAM files that other processes are using. If another process is simultaneously updating the ISAM files, however, the command fails to obtain accurate information for any updates performed just when it obtains information. In order to maintain the integrity of the ISAM files, other processes attempting to access the ISAM files have to wait while the command is executed. You should not, therefore, use this command when the system is executing a large number of jobs.
- The output information from this command with the `-l` or `-L` option specified refers to the ratio of unused areas, not the ratio of fragmentation. If, therefore, the ISAM file contains no records or there are an extremely limited number of records, 100% is output showing the ratio of unused areas to the empty area that has been reserved.
- Reorganizing the ISAM files sometimes fails to completely reorganize the entire files, possibly leaving some small unused areas.
- If you execute this command with the `-x` or `-k` option specified, do not execute the `jpgautocond` command or the `jajs_maintain -m manager` command at the same time.
- You cannot specify the `-x` and `-k` options of this command together.

Return value

| | |
|-----|---|
| 0 | Normal end [#] |
| 1 | The ISAM files being used contain unused areas exceeding the specified threshold size. |
| 100 | Invalid argument specified |
| 132 | The configuration definition information file for submit job execution is not validly coded. |
| 135 | Insufficient system resource |
| 137 | No database storage path |
| 138 | You do not have the privilege required to access the database. |
| 140 | The user does not have administrator privileges (in Windows systems) or superuser privileges (in UNIX systems). |
| 141 | Invalid environment setting or logical host name |
| 145 | Insufficient memory |
| 146 | Insufficient disk space |
| 147 | An error due to an internal cause occurred. |
| 148 | An error occurred in ISAM processing for database reorganization. |
| 149 | Processing cannot be performed because the database size exceeds 2 GB. |
| 226 | Invalid execution environment |

#

When the `-t` and `-v` options are specified simultaneously, indicates that the ISAM files used by the job execution environment have not reached the unused area size threshold.

Additional information

- The following shows the format of output when the `-l` or `-L` option is specified:

| Table name | Record count | Data | Key 1 | Key 2 |
|--------------|--------------|------|-------|-------|
| JPQSYSINFO | 1 | 1% | 0% | |
| JPQQUEINFO | 105 | 10% | 3% | 0% |
| JPQCONINFO | 46 | 1% | 0% | |
| JPQAGTINF | 10 | 1% | 0% | 0% |
| JPQSCHINFO | 528 | 1% | 0% | |
| JPQJOBINFO | 78256 | 56% | 32% | 0% |
| JPQENVINFO | 1 | 1% | 0% | |
| JPQTRANSINFO | 78256 | 56% | 0% | |
| JPQJOBCTRL | 78256 | 56% | 32% | 0% |
| JPQNFYINFO | 78256 | 56% | 0% | |
| JPQRESINFO | 2 | 0% | 0% | 0% |

The following items are output:

Table name

Displays the table name.

Record count

Displays the number of records.

Data

Displays the ratio of unused areas for the data file.

Key 1

Displays the ratio of unused areas for the first key file.

Key 2

Displays the ratio of unused areas for the second key file.

This item is blank if there is only a single key file.

There cannot be more than two key files.

- The following shows the format of output when the `-a` option is specified with the `-l` or `-L` option.

| Table name | Record count | Data | Fragment ratio | Key 1 | Key 2 | Unused area size |
|------------------------|--------------|----------|----------------|---------|---------|------------------|
| JPQSYSINFO | 1 | 0% | - | 0% | | |
| | | 0.003MB | | 0.000MB | | 0.003MB |
| JPQQUEINFO | 28 | 0% | - | 0% | 0% | |
| | | 0.007MB | | 0.000MB | 0.000MB | 0.007MB |
| JPQCONINFO | 46 | 79% | - | 33% | | |
| | | 2.628MB | | 0.000MB | | 2.628MB |
| JPQAGTINFO | 10 | 0% | - | 0% | 0% | |
| | | 0.005MB | | 0.000MB | 0.000MB | 0.005MB |
| JPQSCHINFO | 528 | 0% | - | 0% | | |
| | | 0.000MB | | 0.000MB | | 0.000MB |
| JPQJOBINFO | 2800 | 31% | - | 85% | 98% | |
| | | 24.000MB | | 0.000MB | 0.000MB | 24.000MB |
| JPQENVINFO | 1 | 99% | 50% | 0% | | |
| | | 0.060MB | | 0.000MB | | 0.060MB |
| JPQTRANSINFO | 2800 | 31% | - | 0% | | |
| | | 4.204MB | | 0.000MB | | 4.204MB |
| JPQJOBCTRL | 2800 | 31% | - | 85% | 94% | |
| | | 2.662MB | | 0.000MB | 0.000MB | 2.662MB |
| JPQNFYINFO | 2800 | 31% | - | 85% | | |
| | | 2.191MB | | 0.000MB | | 2.191MB |
| JPQRESINFO | 3 | 45% | - | 10% | 0% | |
| | | 0.010MB | | 0.000MB | 0.000MB | 0.010MB |
| ----- | | | | | | |
| Total unused area size | | | | | | 35.77MB |

Information is output in two rows for each table. The information displayed in the upper row is the same as that displayed with the `-l` or `-L` option. The lower row displays the unused area size for each file (in MB; 1 MB = 1,024 * 1,024 bytes).

The following describes the displayed items:

Table name

Displays the table name.

Record count

Displays the number of records.

Data

When the -a option is specified, data is output in two rows for each table. The data displayed in the upper row is the same as that displayed with the -l or -L option. The lower row displays the unused area size.

Fragment ratio

For a variable-length record, updating a record may cause the data in ISAM files to be split into multiple blocks. This item displays the ratio of the split records to the total number of records. This item is only displayed for variable-length ISAM files. It displays a hyphen (-) for other tables.

Key 1

When the -a option is specified, data is output in two rows for each table. The data displayed in the upper row is the same as that displayed with the -l or -L option. The lower row displays the unused area size.

Key 2

When the -a option is specified, data is output in two rows for each table. The data displayed in the upper row is the same as that displayed with the -l or -L option. The lower row displays the unused area size.

Unused area size

This item displays the total unused area size for the data and key files that comprise each ISAM file.

Total unused area size

Displays the total unused area size for the ISAM files that the job execution environment uses.

- The following shows the format of output when the -m option is specified:

| Table name | Reuse key | Semaphore No. |
|------------|-----------|---------------|
| JPQSYSINFO | Enabled | 1 |
| JPQQUEINFO | Enabled | 1 |
| | : | |
| | Omitted | |
| | : | |
| JPQRESINFO | Enabled | 1 |

The following items are output:

Table name

Displays the table name.

Reuse key

Displays Enabled if the key reuse functionality for the ISAM file format is enabled.

Displays Disabled for the conventional ISAM file format.

Semaphore No.

Displays the semaphore number if the file is split by semaphore.

Otherwise, a hyphen (-) is displayed.

- If you specify j (JP1 event) as the output destination for the -p, -i, or -t option, the following JP1 events are output:

| Specified option | Event ID | Event name | Issued when | Message ID |
|------------------|----------|--|---|------------|
| -p | 00004160 | Job execution environment database reorganization started | Reorganization starts. | KAVU5980-I |
| -p | 00004161 | Job execution environment database reorganization ended normally | Reorganization ends normally. | KAVU5981-I |
| -p | 00004162 | Job execution environment database reorganization ended abnormally | Reorganization ends abnormally. | KAVU5982-E |
| -i | 00004163 | ISAM unused area size information | ISAM unused area size information is obtained. | KAVU5983-I |
| -t | 00004164 | ISAM unused area size threshold reached | The ISAM unused area size threshold is reached. | KAVU5984-W |

Note

For details about the JP1 events, see *A. JP1 Events Issued by JP1/AJS3* in the *JP1/Automatic Job Management System 3 Administration Guide*.

- The following describes a database reorganization log that is output when the database is reorganized:
When you execute the `jpqdbcond` command, it creates the `CONDENSE {1|2} .log` file in the directory storing the database. This file contains the database reorganization log, which records the following statistics:
 - Start date/time, end date/time, and time required
 - Unused area size and total file size before database reorganization
 - Unused area size and total file size after database reorganization

Data is logged in the HNTR log format. The log consists of two planes, each of which contains 512 KB of log data. Message KAVU5985-I is output with the statistics of database reorganization embedded.

Output example

```
KAVU5980-I Database condensing of the job execution environment started. 2
0XX/10/01 01:05:40
KAVU5985-I CONDENSE: Before condensing the database. Unused area size:102.
020 MB Total file size:542.245 MB
KAVU5985-I CONDENSE: After condensing the database. Unused area size:0.10
0 MB Total file size:440.225 MB
KAVU5981-I Database condensing of the job execution environment ended norm
ally. 20XX/10/01 01:05:40 - 20XX/10/01 01:20:20 (00:14:40)
```

4

Commands Used for Special Operation

This chapter describes commands used for special JP1/AJS3 operation.

ajslocaldate

Format

```
ajslocaldate
  [-F service-name]
  [-y]
  { [-d [[year/]month/]day] [-t hours[:minutes]] | [-s seconds] | [-u] }
```

Description

Modifies the local date and time for a JP1/AJS3 scheduler service (date and time managed by JP1/AJS3).

If you execute this command, without specifying the `-y`, `-d`, `-t`, `-s` and `-u` options, the system outputs the local date and time for the JP1/AJS3 scheduler service to the standard output file.

Execution privileges

In Windows: Administrators privileges

In UNIX: Superuser privileges

Arguments

-F *service-name*

Specify the name of the target scheduler service.

You can specify a character string of 1 to 30 bytes.

If you omit this option, the system assumes the default scheduler service name.

-y

Does not display a message with a confirmation prompt before modifying the scheduler service local date and time.

-d [[*year/*]*month/*]*day*

Specify the scheduler service local date.

- *year*

You can specify a value between 1994 and the value of the SCHEDULELIMIT environment setting parameter for the year. For details about the SCHEDULELIMIT environment setting parameter, see *20.4.2(123) SCHEDULELIMIT* in the *JP1/Automatic Job Management System 3 Configuration Guide*.

- *month*

You can specify a value between 1 and 12.

- *day*

You can specify a value between 1 and 31.

-t *hours[:minutes]*

Specify the local time for a scheduler service.

- *hours*

You can specify a value between 0 and 23.

- *minutes*

You can specify a value between 0 and 59.

-s seconds

Specify the difference between the local time for the current scheduler service and the time set in the host.

You can specify a value between -4,294,967,295 and 4,294,967,295 (seconds).

If the resulting year is not within the specifiable year range, an error occurs.

-u

Reset the local date and time for the scheduler service to the initial value (the date and time set in the host).

Notes

- To change the scheduler service local time, stop the scheduler service before executing this command. The new local time is applied to the system the next time the scheduler service is started. If you execute this command while the scheduler service is being started, schedule calculation results, display times, and other items might become incorrect.
- If you have set the scheduler service local date and time to a value in the past, you must use cold start to start a scheduler service. (If you modify the scheduler service local date and time, you cannot restore the information recorded in the schedule monitor information file, such as the job end time, preventing the jobnet from running as scheduled.)
You can use the `ajsstart` command (with the `-c` option specified) to perform cold start for a scheduler service.
- The system generates local time based on the system time. If you modify the system time, make sure that the modification is correctly reflected in the local time.
- To use the local time in a cluster system, execute the `ajslocaldate` command so that both the active and standby machines operate at the same local time.
- If you need to change the local time when a jobnet with start condition is registered for execution, specify an option other than `-c` (`-s`, `-n`, `-j`, or `-k`) in the `ajsstop` command, stop the scheduler service, and then execute the `ajslocaldate` command. If you specify `-c` in the `ajsstop` command to stop the scheduler service, monitoring is not canceled at a time specified within the valid range of the start condition.
- Before changing the scheduler service local time to a time in the past by using this command, you need to check whether there are any jobnets for which a release entry has been made. If there are such jobnets, including jobnets for which a release entry was made in past results, use the `ajsdelete` command to delete the relevant jobnet before changing the time.

If you change the time to a time in the past without deleting the jobnet, a problem might occur during operation. If this happens, restore the time that was set before you made the change, delete the relevant jobnet, and then change the time again.

To restore the jobnet you deleted, you must back up the definition information of the jobnet that will be subject to release by using the `ajsprint` command before registering the release entry of the jobnet. Use the `ajsdefine` command to re-define the definition information of the jobnet you have backed up, and then specify the release source to register the release entry again. In this way, the jobnet subject to release can be restored.

Return values

| | |
|--|--------------|
| 0 | Normal end |
| Multiple of 4 within the range from 4 to 124 | Abnormal end |

Additional information

- The following table shows an example of the display format for the local date and time for a scheduler service:

Table 4–1: Example of the display format for the local date and time for a scheduler service

| Language type | Display format |
|---------------|----------------------|
| Japanese | 20XX/12/01 12:00:00 |
| English | Dec 01 20XX 12:00:00 |

- If there is a change in the local date and time for the scheduler service, the KAVS0210-I message is output to Windows event log or syslog.

ajsqlalter

Format

```
ajsqlalter
  [-l Maximum-number-of-executing-jobs]
  [-b Maximum-number-of-waiting-jobs]
  [-r]
  [-c class-name]
  [-h logical-host-name]
```

Description

Temporarily modifies the operating environment for the queueless agent service.

Execution privileges

In Windows: Administrators privileges

In UNIX: Superuser privileges

Storage directory

In Windows:

JP1/AJS3 - Manager-installation-folder\bin\
JP1/AJS3 - Agent-installation-folder\bin\
JP1/AJS3 - Agent-installation-folder\bin\
JP1/AJS3 - Agent-installation-folder\bin\

In UNIX:

/opt/jp1ajs2/bin/

Arguments

-l *Maximum-number-of-executing-jobs*

Specify the maximum number of queueless jobs that can be executed concurrently.

You can specify a value from 0 to 1,024.

If you execute the command without specifying this option, the command terminates normally, but the maximum number of queueless jobs that can be executed concurrently is not changed.

If you specify the option without specifying its value, the command terminates abnormally.

If you attempt to execute queueless jobs when the number of concurrently executing queueless jobs has already reached the maximum, the jobs are stacked to wait on the queueless agent service. Jobs can be stacked until the maximum number of waiting jobs is reached.

To change the maximum number of concurrently executable jobs for a specific class, execute the command with the `-c` option specified.

To change the maximum number of concurrently executable jobs for the overall queueless agent service (default class), omit the `-c` option.

To change the maximum number of concurrently executable jobs for a class on a logical host, execute the command with both the `-c` and `-h` options specified.

-b *Maximum-number-of-waiting-jobs*

Specify the maximum number of queueless jobs that can be stacked on the queueless agent service.

You can specify a value from 0 to 102,400.

If you execute the command without specifying this option, the command terminates normally, but the maximum number of queueless jobs that can be stacked on the queueless agent service (maximum number of waiting jobs) is not changed.

If you specify the option without specifying its value, the command terminates abnormally.

If an attempt is made to execute a queueless job when the maximum number of waiting jobs has already been reached, the job fails to start.

To change the maximum number of waiting jobs for a specific class, execute the command with the `-c` option specified.

To change the maximum number of waiting jobs for the overall queueless agent service (default class), omit the `-c` option.

To change the maximum number of waiting jobs for a class on a logical host, execute the command with both the `-c` and `-h` options specified.

-r

Erases the user mapping cache.

By default, the system does not erase the user mapping cache.

If you specify this option with the `-h` or `-c` option, the system ignores the specifications of the logical host and class.

-c *class-name*

Specify the name of the class for which you want to temporarily change the operating environment.

If this option is not specified, the entire queueless agent service (default class) is assumed.

This option does not affect the `-r` option.

-h *logical-host-name*

Specify the name of the logical host for which you want to temporarily change the operating environment. You can only specify a logical host on the local host.

If you omit this option, the system assumes the physical host.

This option does not affect the `-r` option.

You must specify this option with the `-c` option.

Notes

1. Before you execute this command, make sure that the queueless agent service is started and the queueless job execution environment for the relevant logical host is set up. If the queueless job execution environment for the relevant logical host has not yet been set up, execute the `ajsqlsetup` command to set up the queueless job execution environment. For details on the `ajsqlsetup` command, see [ajsqlsetup in 4. Commands Used for Special Operation](#).
2. When you execute the command with the `-r` option specified, make sure that a queueless job is not being executed.

3. After you change the login shell, password, and other information about the OS user who executes queueless jobs, you must clear the user mapping cache. The cache can be cleared by executing the command with the `-r` option specified. If you continue operation without clearing the cache, queueless jobs executed after the OS user information is changed might fail to start or end abnormally.

Note that the user mapping cache is also erased when the queueless agent service and queueless file transfer service are restarted.

Return values

| | |
|--------------|--------------|
| 0 | Normal end |
| Other than 0 | Abnormal end |

Example

In this example, the command changes the maximum number of concurrently executable jobs for the overall queueless agent service (default class) to 50.

```
ajsqlalter -l 50
```

ajsqlattach

Format

```
ajsqlattach  
  [-h logical-host-name]
```

Description

The `ajsqlattach` command attaches (connects) a logical host to the queueless agent service.

Execution privileges

In Windows: Administrators privileges

In UNIX: Superuser privileges

Storage directory

In Windows:

JPI/AJS3 - Manager-installation-folder\bin

JPI/AJS3 - Agent-installation-folder\bin

In UNIX:

/opt/jp1ajs2/bin/

Arguments

-h *logical-host-name*

Specify the name of the logical host you want to attach to the queueless agent service.

If you omit this option, the system assumes the physical host.

If you specify the option without specifying its value, the command terminates abnormally.

Notes

1. Before you execute this command, make sure that the queueless agent service is started and the queueless job execution environment for the relevant logical host is set up. If the queueless job execution environment for the relevant logical host has not yet been set up, execute the `ajsqlsetup` command to set up the queueless job execution environment. For details on the `ajsqlsetup` command, see [ajsqlsetup](#) in *4. Commands Used for Special Operation*.
2. If an attempt is made to execute a queueless job on a logical host that has not been attached, either the queueless job is executed on the physical host according to the value of the `AJSQL_NOATTACHREQ` environment setting parameter or the queueless job fails to start. For details about how to set the `AJSQL_NOATTACHREQ` environment setting parameter, see *20.10 Setting up the queueless job execution environment* in the *JPI/Automatic Job Management System 3 Configuration Guide*.

Return values

| | |
|--------------|--------------|
| 0 | Normal end |
| Other than 0 | Abnormal end |

Example

In this example, the command attaches logical host `newhost` to the queueless agent service.

```
ajsqlattach -h newhost
```

ajsqldetach

Format

```
ajsqldetach  
  [-h logical-host-name]  
  [-k]
```

Description

The `ajsqldetach` command detaches (disconnects) a logical host from the queueless agent service.

Execution privileges

In Windows: Administrators privileges

In UNIX: Superuser privileges

Storage directory

In Windows:

```
JP1/AJS3 - Manager-installation-folder\bin\  
JP1/AJS3 - Agent-installation-folder\bin\  

```

In UNIX:

```
/opt/jp1ajs2/bin/
```

Arguments

-h *logical-host-name*

Specify the name of the logical host you want to detach from the queueless agent service.

If you omit this option, the system assumes the physical host.

If you specify the option without specifying its value, the command terminates abnormally.

-k

If there are queueless jobs running on the logical host you want to detach from the queueless agent service, these jobs are forcibly terminated, and then the logical host is detached. (This is called a *forced detach*.)

If this option is omitted, the logical host is not detached from the queueless agent service until all queueless jobs running on the logical host terminate. (This is called a *planned detach*.)

Notes

- Before you execute this command, make sure that the queueless agent service is started and the queueless job execution environment for the relevant logical host is set up. If the queueless job execution environment for the relevant logical host has not yet been set up, set it up by executing the `ajsqlsetup` command. For details on the `ajsqlsetup` command, see *ajsqlsetup* in 4. *Commands Used for Special Operation*.
- If an attempt is made to execute a queueless job on a logical host that has not been attached, either the queueless job is executed on the physical host according to the value of the `AJSQL_NOATTACHREQ` environment setting parameter or the queueless job fails to start. For details about how to set the `AJSQL_NOATTACHREQ` environment setting

parameter, see *20.10 Setting up the queueless job execution environment in the JP1/Automatic Job Management System 3 Configuration Guide*.

- If a forced detach is attempted when many queueless jobs are running on the logical host you want to detach from the queueless agent service, forced termination might take a long time before the logical host is detached.

Return values

| | |
|--------------|--------------|
| 0 | Normal end |
| Other than 0 | Abnormal end |

Example

In this example, the command detaches logical host `newhost` from the queueless agent service.

```
ajsqldetach -h newhost
```

ajsqlxecsetsz

Format

For JP1/AJS3 - Manager:

```
ajsqlxecsetsz
  [[-a] [-h logical-host-name] |-f]
  [-s size]
```

For JP1/AJS3 - Agent:

```
ajsqlxecsetsz
  [-a]
  [-h logical-host-name]
  [-s size]
```

Description

The `ajsqlxecsetsz` command changes the size of the internal log file for execution of queueless jobs or outputs the file size that is currently set.

Execution privileges

In Windows: Administrators privileges

In UNIX: Superuser privileges

Storage directory

In Windows:

```
JP1/AJS3 - Manager-installation-folder\bin\  
JP1/AJS3 - Agent-installation-folder\bin\  

```

In UNIX:

```
/opt/jplajs2/bin/
```

Arguments

-a

Specify this option if the internal log file for which you want to change the size or output the current size setting to the standard output is `ajsqlxeclog`, which contains log data output by the queueless agent service.

You cannot specify this option with the `-f` option.

-h *logical-host-name*

Specify the name of the logical host that contains the `ajsqlxeclog` file, which is the target file if the `-a` option is specified. If the `-h` option is omitted, the physical host is assumed.

You cannot specify the `-h` option if you specify the `-f` option.

-f

Specify this option if the internal log file for which you want to change the size or output the current size setting to the standard output is `ajsqlexeclog_ftpd`, which contains log data output by the queueless file transfer service.

You cannot specify this option with the `-a` option.

-s size

If you want to use the command to change the size of the internal log file for execution of queueless jobs, specify the new file size in kilobytes.

You can specify a value from 2,048 to 2,097,151. If this option is omitted, the current size setting of the internal log file for execution of queueless jobs is output to the standard output.

Notes

1. Before executing this command, you must set up a queueless job execution environment. If the queueless job execution environment has not yet been set up, execute the `ajsqlsetup` command to set up the queueless job execution environment. If you execute this command in a cluster environment, set up the queueless job execution environment for the relevant logical host.
For details on the `ajsqlsetup` command, see [ajsqlsetup](#) in *4. Commands Used for Special Operation*.
2. If you use this command to decrease the size of the internal log file for execution of queueless jobs, the contents of the file are cleared.
3. The internal log file for execution of queueless jobs is created on the local disk regardless of whether the host is a physical host or logical host. Therefore, you need to execute this command on both the primary and secondary nodes.

Return values

| | |
|--------------|--------------|
| 0 | Normal end |
| Other than 0 | Abnormal end |

Example

In this example, the command increases the size of the `ajsqlexeclog` file on logical host `Lhost` to 32,768 KB (32 MB).

```
ajsqlexecsetsz -a -h Lhost -s 32768
```

ajsqlftpstart (UNIX only)

Format

```
ajsqlftpstart
```

Description

Starts the queueless file transfer service.

Execution privileges

Superuser privileges

Storage directory

/opt/jp1ajs2/bin/

Arguments

None

Notes

1. Before executing this command, you must start the queueless agent service and set up a queueless job execution environment. If the queueless job execution environment has not yet been set up, execute the `ajsqlsetup` command to set up the queueless job execution environment. If you execute this command in a cluster environment, set up the queueless job execution environment for the relevant logical host.

For details on the `ajsqlsetup` command, see *ajsqlsetup* in [4. Commands Used for Special Operation](#).

2. This command is valid only for UNIX. It is not applicable to Windows.
3. This command ends without waiting for the service to complete startup. Use the `ajsqlstatus` command to check whether the service is running.

Return values

| | |
|--------------|--------------|
| 0 | Normal end |
| Other than 0 | Abnormal end |

ajsqlftpstop

Format

```
ajsqlftpstop  
[-j|-c]
```

Description

Stops the queueless file transfer service.

Execution privileges

In Windows: Administrators privileges

In UNIX: Superuser privileges

Storage directory

In Windows:

JP1/AJS3 - Manager-installation-folder\bin

In UNIX:

/opt/jp1ajs2/bin/

Arguments

-j

The queueless file transfer service is stopped after all transfer processes that are currently running terminate.

You cannot specify this option with the **-c** option.

-c

The queueless file transfer service is stopped immediately even when there are running transfer processes.

You cannot specify this option with the **-j** option.

Notes

1. Before executing this command, you must start the queueless agent service and set up a queueless job execution environment. If the queueless job execution environment has not yet been set up, execute the `ajsqlsetup` command to set up the queueless job execution environment. If you execute this command in a cluster environment, set up the queueless job execution environment for the relevant logical host.
For details on the `ajsqlsetup` command, see [ajsqlsetup](#) in *4. Commands Used for Special Operation*.
2. If you specify no option, the system assumes **-j**.
3. This command terminates when a stop request is sent to the queueless file transfer service. Therefore, you cannot use this command to check whether the queueless file transfer service has stopped. To perform this check, use the `ajsqlstatus` command. For details on the `ajsqlstatus` command, see [ajsqlstatus](#) in *4. Commands Used for Special Operation*.
4. If you stop the queueless file transfer service by executing the command with the **-c** option specified, the status of queueless jobs running when the command is executed might change to *Failed to start* or *Ended abnormally*. If there

are queueless jobs in *Failed to start* or *Ended abnormally* status after the command is executed, restart the queueless file transfer service to start the jobs, if necessary.

Return values

| | |
|--------------|--------------|
| 0 | Normal end |
| Other than 0 | Abnormal end |

ajsqlsetup

Format

For JP1/AJS3 - Manager

```
ajsqlsetup
  [-h logical-host-name]
  [-F scheduler-service-name]
  [-nc]
  [[-m] [-a]] | [-r] | [-u]
```

For JP1/AJS3 - Agent

```
ajsqlsetup
  [-h logical-host-name]
  [-a] | [-u]
```

Description

Sets up a queueless job execution environment. This command cannot be used for JP1/AJS3 - Agent Minimal Edition.

We do not recommend that you use queueless jobs because they do not support execution agents and execution agent groups. Unless there is a good reason, do not specify the queueless agent as the execution target service.

The following shows the information set by this command.

Service registration

Register the following services used by queueless job execution:

| Service | JP1/AJS3 - Manager | JP1/AJS3 - Agent |
|--|--------------------|------------------|
| JP1/AJS3 Queueless Agent service | Y#1 | Y#1 |
| JP1/AJS3 Queueless File Transfer service | Y#2 | -- |

Setting between service dependency

Set the dependency between JP1/AJS3 services and the queueless agent service or the queueless file transfer service.

| Services on which JP1/AJS3 service depends | JP1/AJS3 - Manager | JP1/AJS3 - Agent |
|--|--------------------|------------------|
| JP1/AJS3 Queueless Agent service | Y#3 | -- |
| JP1/AJS3 Queueless File Transfer service | Y#2 | -- |

Setting communication ports

Registers the following communication ports used for queueless job execution in the services file:

| Communication port (<i>service-name:port-number</i>) | JP1/AJS3 - Manager | JP1/AJS3 - Agent |
|--|--------------------|------------------|
| Queueless job execution (jp1ajs2qlagt: 20300) | Y | Y |
| Queueless file transfer (jp1ajs2qlftp: 20301) | Y | Y |

Setting environment setting parameters

Set environment setting parameters used for executing queueless jobs.

| Settings | | JP1/AJS3 - Manager | JP1/AJS3 - Agent |
|--|---|--------------------|------------------|
| Definition key | Environment setting parameters | | |
| [JP1_DEFAULT\JP1AJSMANAGER]#6 | "QLMANCHARCODE"=UTF-8 | Y#4 | -- |
| [JP1_DEFAULT\JP1AJSMANAGER\scheduler-service-name] or [logical-host-name\JP1AJSMANAGER\scheduler-service-name]#6 | "QUEUELESSMULTIREQ"=dword:00000001 | Y#2 | -- |
| [JP1_DEFAULT\JP1QLAGENT]#6 | <ul style="list-style-type: none"> In Windows: "AJSQ_L_JOBMAX"=dword:00000005 In UNIX: "AJSQ_L_JOBMAX"=dword:00000400 | Y#1 | Y#1 |
| | <ul style="list-style-type: none"> In Windows: "AJSQ_L_JOBWAITMAX"=dword:00000800 In UNIX: "AJSQ_L_JOBWAITMAX"=dword:00000000 | Y#1 | Y#1 |
| | "AJSQ_L_TRACELOGFILE"=#5 | Y | Y#1 |
| [JP1_DEFAULT\JP1QLAGENT] or [logical-host-name\JP1QLAGENT]#6 | "AJSQ_L_LOGFILE"=#5 | Y#1 | Y#1 |
| | "AJSQ_L_LOGSIZE"=dword:00002000 | Y#1 | Y#1 |
| | "AJSQ_L_STATFILE"=#5 | Y#1 | Y#1 |
| | "AJSQ_L_STATSIZE"=dword:00000800 | Y#1 | Y#1 |

Creation of job ID management file

Creates a file for managing the job IDs to be added to the queueless jobs to be executed.

| File name | JP1/AJS3 - Manager | JP1/AJS3 - Agent |
|---|--------------------|------------------|
| <ul style="list-style-type: none"> In Windows: <i>Database-folder-of-scheduler-service</i> AJSQ_LJID.dat In UNIX: <i>Database-directory-of-scheduler-service</i> /AJSQ_LJID.dat | Y#2 | -- |

Legend:

Y: Supported

--: Not supported

#1

This is set only when the agent function is used with JP1/AJS3 - Manager or JP1/AJS3 - Agent and the `-a` option is specified.

#2

This is set only when the manager function is used with JP1/AJS3 - Manager and the `-m` option is specified.

#3

This is set only when the agent function is used with JP1/AJS3 - Manager and the `-a` option is specified.

#4

This is set only when the manager function is used with the Linux edition of JP1/AJS3 - Manager and the `-m` option is specified.

#5

The value varies depending on the environment. For details about environment setting parameter, see *20.10 Setting up the queueless job execution environment* in the *JP1/Automatic Job Management System 3 Configuration Guide*.

#6

If you want to change the value of an environment setting parameter that has been set, we recommend that you use the `jajs_config` command. Because this command validates the specified environment parameter name and other values, you can use this command to ensure that correct values are set. For details on the `jajs_config` command, see *jajs_config* in *2. Commands Used during Setup*.

If you want to change multiple environment setting parameter values at the same time, make sure that you use the `jbssetcnf` command. For details on the `jbssetcnf` command, see the *JP1/Base User's Guide*.

Execution privileges

In Windows: Administrators privileges

In UNIX: Superuser privileges

Storage directory

In Windows:

`JP1/AJS3 - Manager-installation-folder\bin\`

`JP1/AJS3 - Agent-installation-folder\bin\`

In UNIX:

`/opt/jplajs2/bin/`

Arguments

-h *logical-host-name*

Specify the logical host name (logical host name set by JP1/Base) to be set up and used in the cluster environment.

If you omit this option, the system assumes the physical host. If, however, environment variable `JP1_HOSTNAME` is specified, the system assumes the host set in the variable.

To specify a physical host explicitly, specify `JP1_DEFAULT` in this option.

This option is valid when you specify the `-m`, `-a`, or `-r` option.

-F scheduler-service-name

Specify the name of the scheduler service to be set up.

You can specify this option only with JP1/AJS3 - Manager, not with JP1/AJS3 - Agent.

If you omit this option, the system assumes the default scheduler service. If, however, environment variable `AJSCONF` is specified, the system assumes the scheduler service set in the variable.

This option is valid when you specify the `-m` or `-r` option.

-nc

If this option is specified, the command neither creates a job ID management file nor checks whether the file exists on the shared disk. Specify this option only when you set up the secondary node in a cluster environment. This option is valid only when you specify the `-m` option.

-m

Sets up the queueless job management function.

You can specify this option only with JP1/AJS3 - Manager; not with JP1/AJS3 - Agent.

You cannot specify this option together with the `-r` or `-u` option in the same command.

-a

Sets up the queueless job agent function.

You cannot specify this option together with the `-r` or `-u` option in the same command.

-r

If this option is specified, the command stops the JP1/AJS3 service, and disables the queueless job manager function for the scheduler service specified in the `-F` option or the `AJSCONF` environment variable. A scheduler service for which the manager function is disabled cannot send queueless jobs.

You can specify this option only with JP1/AJS3 - Manager, not JP1/AJS3 - Agent.

You cannot specify this option together with the `-m`, `-a`, or `-u` option in the same command.

-u

If this option is specified, the command stops the JP1/AJS3 service, and deletes the queueless job execution environment settings from the JP1/AJS3 service.

For Windows, from the list of services in Windows **Administrative Tools**, delete the queueless agent service (JP1/AJS3 Queueless Agent) and the queueless file transfer service (JP1/AJS3 Queueless File Transfer).

You cannot specify this option together with the `-r`, `-m`, or `-a` option in the same command.

Notes

- Before you specify the `-m` option to set up the manager function or specify the `-a` option to set up the agent function, make sure that the JP1/AJS3 service has stopped. If the queueless agent service and queueless file transfer service

have already been registered by using the `ajsq1setup` command, you must also make sure that these services have stopped.

- Before you specify the `-r` option to disable the queueless job manager function or specify the `-u` option to delete the queueless job execution environment settings, make sure that JP1/AJS3 operation has stopped. The command does not wait until JP1/AJS3 operation stops before disabling the queueless job manager function or deleting the queueless job execution environment settings. Therefore, if you do not stop JP1/AJS3 operation, it might be affected by the command execution.
- If you omit the option specifying the setting type (`-m`, `-a`, `-r`, or `-u`), the system assumes the following options:
 - For JP1/AJS3 - Manager: `-m`, `-a`
 - For JP1/AJS3 - Agent: `-a`
- To run JP1/AJS3 - Manager or JP1/AJS3 - Agent using the same options as 07-50, perform the following procedure:
 1. Copy `ajs2q1_0750.conf.model` to `ajs2q1_0750.conf`.
 2. Edit `ajs2q1_0750.conf` as necessary.
 3. Execute the `jbssetcnf` command.
Example:

```
jbssetcnf ajs2q1_0750.conf
```
- Before you execute this command on a computer running Windows, make sure that you open the Command Prompt window as an administrator. If the UAC function is disabled, you do not need to open the Command Prompt window as an administrator.

Return values

| | |
|---------------------|--------------|
| 0 | Normal end |
| Values other than 0 | Abnormal end |

ajsqlstart (UNIX only)

Format

```
ajsqlstart
```

Description

Starts the queueless agent service.

Execution privileges

Superuser privileges

Storage directory

/opt/jp1ajs2/bin/

Arguments

None

Notes

1. Before executing this command, you must set up a queueless job execution environment. If the queueless job execution environment has not yet been set up, execute the `ajsqlsetup` command to set up the queueless job execution environment. If you execute this command in a cluster environment, set up the queueless job execution environment for the relevant logical host.
For details on the `ajsqlsetup` command, see [ajsqlsetup in 4. Commands Used for Special Operation](#).
2. This command is valid only for UNIX. It is not applicable to Windows.
3. This command ends without waiting for the service to complete startup. Use the `ajsqlstatus` command to check whether the service is running. For details on the `ajsqlstatus` command, see [ajsqlstatus in 4. Commands Used for Special Operation](#).

Return values

| | |
|---------------------|--------------|
| 0 | Normal end |
| Values other than 0 | Abnormal end |

ajsqlstatus

Format

```
ajsqlstatus  
[-h logical-host-name]
```

Description

Outputs detailed information about the queueless agent service.

Execution privileges

None

Storage directory

In Windows:

JP1/AJS3 - Manager-installation-folder\bin\
JP1/AJS3 - Agent-installation-folder\bin\
JP1/AJS3 - Agent-installation-folder\bin\
JP1/AJS3 - Agent-installation-folder\bin\

In UNIX:

/opt/jp1ajs2/bin/

Arguments

-h *logical-host-name*

Specify the name of the logical host to which detailed information needs to be output.

If you omit this option, the physical host is assumed.

If you specify the option without specifying its value, the command terminates abnormally.

Return values

| | |
|--------------|-----------------|
| 0 | Ends normally |
| Other than 0 | Ends abnormally |

Example

The detailed information about the queueless agent service is output to the standard output.

```
ajsqlstatus
```

Output example

| | | |
|------|--------------------------------------|--|
| (1) | Queueless agent service | active |
| (2) | Queueless file transfer service | inactive |
| (3) | Host name | host01 |
| (4) | Queueless job | can execute |
| (5) | Execution request to logical host | executes in physical host |
| (6) | Attach when service starts | attach |
| (7) | Log file installation directory name | C:\Program Files\HITACHI\JP1AJS2\log |
| (8) | Log file size | 4096KB |
| (9) | Status file name | C:\Program Files\HITACHI\JP1AJS2\log\ajsqlstat.dat |
| (10) | Status file size | 0KB |
| (11) | Trace log file name | C:\Program Files\HITACHI\JP1AJS2\tracelog.ql |
| (12) | Character code | C |
| (13) | Using user profile | use |
| (14) | Directory name for temporary files | C:\Program Files\HITACHI\JP1AJS2\tmp\QLAgent |
| (15) | Class name | default |
| (16) | Maximum number of executing jobs | 1024 |
| (17) | Maximum number of waiting jobs | 10 |

Explanation of the displayed items

The details about each displayed item are explained here. The parentheses for individual display items refer to the output format applicable when C is used for the value of the LANG environment variable for OS users executing the command in UNIX.

When JP1/AJS3 - Agent is installed on a host, the queueless file transfer service is not installed and item 2 is not displayed.

Item 13 is displayed only when the host is running on Windows.

Items 15 to 17 are displayed for each class defined in the target host. For output, a line-feed character is inserted at the beginning of each line.

(1) Queueless agent service

Indicates the startup status of the queueless agent service.

`active`: Operation of the queueless agent service has started.

`inactive`: Operation of the queueless agent service has stopped.

`restricted processing . . .`: Because the queueless agent service is being stopped, the service cannot accept execution requests for jobs or commands. When the currently executed job ends, the queueless agent service stops.

`forcibly stopping . . .`: Because the queueless agent service is being stopped, the service cannot accept execution requests for jobs or commands. The queueless agent service stops without waiting for the end of the job being executed. However, if file transfer is being performed, the queueless agent service waits until the file transfer is completed.

(2) Queueless file transfer service

Indicates the startup status of the queueless file transfer service.

`active`: Operation of the queueless file transfer service has started.

`inactive`: Operation of the queueless file transfer service has stopped.

`restricted processing . . .`: Because the queueless file transfer service is being stopped, the service cannot accept execution requests for commands. When the file transfer processing ends, the queueless file transfer service stops.

If the queueless file transfer service is not set up, `inactive` is displayed.

(3) Host name

Indicates the target host name.

(4) Queueless job

Indicates whether Queueless jobs can be executed on the target host.

can execute: Queueless jobs can be executed on the target host.

cannot execute: Queueless jobs cannot be executed on the target host.

detach processing . . . : Queueless jobs cannot be executed, because the target host is being detached.

(5) Execution request to logical host

Indicates the processing to be performed when a logical host that is not specified to process Queueless jobs is requested to execute such jobs.

executes in physical host: The job is executed on the physical host.

does not execute: The job is not executed.

(6) Attach when service starts

Indicates whether the target host is attached when the queueless agent service is started.

attach: The target host is attached when the queueless agent service is started.

do not attach: The target host is not attached when the queueless agent service is started.

(7) Log file installation directory name

Indicates the name of the log file storage directory for the queueless agent service.

(8) Log file size

Indicates the size of the log file for the queueless agent service (unit: kilobytes).

(9) Status file name

Indicates the name of the status file for the queueless agent service.

(10) Status file size

Indicates the size of the status file for the queueless agent service (unit: kilobytes).

(11) Trace log file name

Indicates the name of the queueless trace log file.

(12) Character code

Indicates the character set specified for the queueless agent service.

C: The ASCII character set is specified for the queueless agent service.

SJIS: SJIS character set is specified for the queueless agent service.

EUC: EUC character set is specified for the queueless agent service.

UTF-8: UTF-8 character set is specified for the queueless agent service.

(13) Using user profile

Indicates whether user profiles are used.

use: User profiles are used.

do not use: User profiles are not used.

(14) Directory name for temporary files

Indicates the name of the directory for temporary files used by the queueless agent service.

(15) Class name

Indicates the class name defined for the target host.

For the entire queueless agent service (default class), `Default` is displayed as the class name.

(16) Maximum number of executing jobs

Indicates the maximum number of jobs that can be executed simultaneously for each class on the target host.

(17) Maximum number of waiting jobs

Indicates the maximum number of jobs that can wait for each class on the target host.

ajsqlstop

Format

```
ajsqlstop  
[-j|-c]
```

Description

Stops the queueless agent service.

Execution privileges

In Windows: Administrators privileges

In UNIX: Superuser privileges

Storage directory

In Windows:

JP1/AJS3 - Manager-installation-folder\bin

JP1/AJS3 - Agent-installation-folder\bin

In UNIX:

/opt/jp1ajs2/bin/

Arguments

-j

The queueless agent service is stopped after all queueless jobs that are currently running terminate.

You cannot specify this option with the **-c** option.

-c

The queueless agent service is stopped immediately even when there are running queueless jobs.

You cannot specify this option with the **-j** option.

Notes

1. Before executing this command, you must start the queueless agent service and set up a queueless job execution environment. If the queueless job execution environment has not yet been set up, execute the `ajsqlsetup` command to set up the queueless job execution environment. If you execute this command in a cluster environment, set up the queueless job execution environment for the relevant logical host.
For details on the `ajsqlsetup` command, see *ajsqlsetup* in [4. Commands Used for Special Operation](#).
2. If you specify no option, the system assumes **-j**.
3. This command terminates when a stop request is sent to the queueless agent service. Therefore, you cannot use this command to check whether the queueless agent service has stopped. To perform this check, use the `ajsqlstatus` command. For details on the `ajsqlstatus` command, see *ajsqlstatus* in [4. Commands Used for Special Operation](#).
4. If you stop the queueless agent service by executing the command with the **-c** option specified, the status of queueless jobs running when the command is executed might change to *Failed to start* or *Ended abnormally*. If there

are queueless jobs in *Failed to start* or *Ended abnormally* status after the command is executed, restart the queueless agent service to start the jobs, if necessary.

Return values

| | |
|--------------|--------------|
| 0 | Normal end |
| Other than 0 | Abnormal end |

ajsqltrsetsz

Format

```
ajsqltrsetsz  
  [-s size]
```

Description

The `ajsqltrsetsz` command changes the size of the queueless trace log file or outputs the file size that is currently set.

Execution privileges

In Windows: Administrators privileges

In UNIX: Superuser privileges

Storage directory

In Windows:

JP1/AJS3 - Manager-installation-folder\bin

JP1/AJS3 - Agent-installation-folder\bin

In UNIX:

/opt/jp1ajs2/bin/

Arguments

-s size

If you want to use the command to change the size of the queueless trace log file, specify the new file size in kilobytes.

You can specify 64 to 2,097,151.

Notes

1. Before executing this command, you must set up a queueless job execution environment. If the queueless job execution environment has not yet been set up, execute the `ajsqlsetup` command to set up the queueless job execution environment. If you execute this command in a cluster environment, set up the queueless job execution environment for the relevant logical host.

For details on the `ajsqlsetup` command, see *ajsqlsetup* in [4. Commands Used for Special Operation](#).

2. If you use this command to decrease the size of the queueless trace log file, the contents of the file are cleared.
3. Always separate an option and its value by at least one space character.

Return values

| | |
|--------------------|--------------|
| 0 | Normal end |
| Value other than 0 | Abnormal end |

Example

The following command expands the size of the queueless trace log file to 16 megabytes (16,384 kilobytes).

```
ajsontrsetsz -s 16384
```

jajs_maintain

Format

```
jajs_maintain
  [-h logical-host-name]
  [-F scheduler-service-name]
  {-m {manager|scheduler}|-show|-r start}
  [-x degree-of-parallelism]
  [-c disconnection-status-monitoring-time]
```

Description

The `jajs_maintain` command performs maintenance of the JP1/AJS3 ISAM database.

Execution privileges

In Windows: Administrators privileges

In UNIX: Superuser privileges

Arguments

-h *logical-host-name*

Specify the target logical host in a cluster operation that will be placed in the maintenance mode.

By default, the system assumes the logical host name specified by the `JP1_HOSTNAME` environment variable. Without the `JP1_HOSTNAME` environment variable, however, the system assumes the local host name.

1 to 255 bytes of characters can be specified.

-F *scheduler-service-name*

Specify the name of the target scheduler service that will be placed in the maintenance mode. In the scheduler service reduction mode, maintenance will apply to only the service specified with this option.

By default, all scheduler services subordinate to the physical host or logical host will be placed in the reduction mode.

If you specify this option with the manager functionality reduction mode, the command will end abnormally.

1 to 30 bytes of characters can be specified.

-m {*manager*|*scheduler*}

Specify the maintenance mode.

- `manager`

Performs maintenance in the manager functionality reduction mode.

- For standard configuration:

The job execution environment is subject to maintenance.

- For compatible ISAM configuration:

The job execution environment and scheduler service are subject to maintenance.

You can specify this option with the `-h` option.

- `scheduler`

Performs maintenance in the scheduler service reduction mode.

- For standard configuration:
Nothing is subject to maintenance.
- For compatible ISAM configuration:
The scheduler service is subject to maintenance.

You can specify this option with the `-h` and `-F` options.

For notes on each maintenance mode, see *7.1.3(3)(c) Notes on maintenance mode* in the *JP1/Automatic Job Management System 3 System Design (Configuration) Guide*.

-show

Displays the operating status of the job execution environment. This option cannot be specified together with the `-m`, `-r`, `-x`, or `-c` option.

One of the following is output as the status of the job execution environment:

- `active`: Operation of JP1/AJS3 has started.
- `inactive`: Operation of JP1/AJS3 has stopped.
- `Now starting`: Operation of JP1/AJS3 is being started.
- `Planned terminating`: Operation of JP1/AJS3 is undergoing a planned stop.
- `Now terminating`: Operation of JP1/AJS3 is being stopped.
- `Maintenance`: Maintenance is being performed on the operation of JP1/AJS3.

-r start

If the job execution environment and the scheduler service remain in the maintenance status because the processing of the `jajs_maintain` command is canceled for whatever reason, this option restores them to operating status.

If you simultaneously specify the `-F` option, only the job execution environment and the specified scheduler service are restored to operating status.

If the target job execution environment and scheduler service are being maintained elsewhere, this command ends abnormally. If the target job execution environment and scheduler service are inactive or are being used, no restoration is performed even if you execute this command. In such a case, the command ends normally.

Do not specify this option together with the `-m`, `-show`, `-x`, or `-c` option.

-x degree-of-parallelism

Specify the number of concurrent scheduler services for which reorganization should be performed. You can specify 1 to 20.

-c disconnection-status-monitoring-time

Specify how long the system will monitor for disconnection from the scheduler database when the manager functionality enters the reduction mode. The system will monitor for disconnection at intervals of 10 seconds within the specified period of time.

You can set 0 to 86,400 (seconds). The default is 60 seconds.

Notes

1. During maintenance of the job execution environment, you cannot execute job entry and execution commands. Using such commands causes an error message KAVU0950-E to appear in the standard error output file.
2. If you attempt to operate a unit from JP1/AJS3 - View during maintenance of scheduler service, a KAVV461-E The connection is not possible because the specified scheduler service is under maintenance. message appears in the message box.
When you execute a command that manipulates a unit, a KAVS1717-E Maintenance is being performed, so execution is impossible message is output to the standard error output.
3. When the `jaajs_maintain` command is executed, log data about reorganization is output to the maintenance log file.
If maintenance processing terminates abnormally, check the maintenance log file for the cause of the abnormal termination, correct the cause, and then re-execute the maintenance processing.
For the location of the maintenance log file, see the description of the maintenance log file in *1.2.5 List of log files and directories* in the manual *JP1/Automatic Job Management System 3 Troubleshooting*.
4. If you stop the JP1/AJS3 service when the manager functionality is reduced, information about any jobs for which the status has changed during the reduction period will be lost. Do not stop JP1/AJS3 when the manager functionality is reduced.
5. If you execute the command in the manager functionality reduction mode when JP1/AJS3 is stopped, the command will require long time to terminate.
6. If the processing of the `jaajs_maintain` command is canceled for whatever reason when the scheduler service to be maintained is being used, the scheduler service and the event action control manager might remain in maintenance status. To restore them, you must use the `jaajs_maintain -r start`, `ajsstart`, or `jaajs_spmd` command to start the applicable service.
In the above situation, the job execution environment might remain in maintenance status as well. To restore it, execute `jaajs_maintain -r start`, or restart the JP1/AJS3 service.
7. If you specify any of the following options in the `jaajs_maintain` command, do not execute multiple instances of the command:
 - `-m manager`
 - `-m scheduler`
 - `-r start`
8. If you specify the `-m manager` option in the `jaajs_maintain` command, do not concurrently execute the command and the following command or script:
 - The `jpgqdbcond` command with the `-x` or `-k` option specified
 - The `jpgqautocond` script
9. You cannot specify `-m manager` if any command or API for the job execution environment is still running.
10. You cannot specify `-m manager` while job information is being deleted in the job execution environment.
If maintenance is performed in the manager functionality reduction mode while job information is being deleted, job information deletion processing is interrupted until the maintenance is completed. The processing is resumed when the maintenance is completed.
11. You cannot specify `jaajs_maintain -m manager` while JP1/AJS3 is starting or finishing. You cannot start or finish JP1/AJS3 while `jaajs_maintain -m manager` is executing.
12. If you specify the `-m manager` option in the `jaajs_maintain` command, do not concurrently execute the command and the `jpgqexport` command.

13. If you specify either of the following options in this command, do not concurrently execute the command and the `ajsautocond` script:
 - `-m manager`
 - `-m scheduler`
14. If the `jajs_maintain -show` or `jajs_maintain -r start` command is executed while starting or finishing JP1/JP1/AJS3, messages KAVU2227-E, KAVU0215-E, or KAVU0220-E might be output in the integrated log. These messages, which are output when maintenance operation conflicts with start or finish processing of the JP1/AJS3 service, do not pose a problem for actual operation. However, execution of the `jajs_maintain` command might take more time. If the command terminates abnormally, re-execute the command.
15. When maintenance of the scheduler service is attempted, the scheduler service is stopped after all existing job execution requests are completed. Therefore, if the max number of simultaneous jobs is set as 0 and the max number of waiting jobs is set more than 1 in the queueless job execution environment settings, the `jajs_maintain` command cannot terminate because the scheduler service cannot start finish processing when the maintenance mode is entered while the queueless job is starting. The `jajs_maintain` command should be executed in a status that allows jobs to execute. If fall into this status, set the max number of simultaneous jobs more than 1 by the `ajsqlalter` command, and execute the jobs.
16. For notes on maintenance of the scheduler service that is executing event jobs and custom event jobs (including jobs specified in start conditions), see *7.6.8 Notes on restarting the JP1/AJS3 service while event jobs are running in the JP1/Automatic Job Management System 3 System Design (Work Tasks) Guide* or *7.10.2 Notes on restarting the JP1/AJS3 service while custom event jobs are running in the JP1/Automatic Job Management System 3 System Design (Work Tasks) Guide*.

Return values

| | |
|--------------|--------------|
| 0 | Normal end |
| Other than 0 | Abnormal end |

Example

To perform maintenance periodically, you can define and execute the `jajs_maintain` command as a JP1/AJS3 job.

Suppose you reorganize the database in the manager functionality reduction mode at 23:00 on the last open day in December every year. You can use the following unit definition parameter to define a jobnet and register planned execution. The following shows examples for Windows and UNIX:

- For Windows

```
unit=maintain-net;
{
  ty=n;
  sd=1,12/*b;
  st=1,23:00;
  cy=1,(1,y);
  sh=1,ca;
  unit=maintain-job;
  {
    ty=pj;
    sc="jajs_maintain.exe";
    prm="-m manager";
  }
}
```

- For UNIX

```
unit=maintain-net;
{
  ty=n;
  sd=1,12/*b;
  st=1,23:00;
  cy=1,(1,y);
  sh=1,ca;
  unit=maintain-job;
  {
    ty=j;
    te="/opt/jplajs2/bin/jajs_maintain -m manager";
  }
}
```

jajsacfg (Windows only)

Format

```
jajsacfg
```

Description

The `jajsacfg` command opens the Agent Environment Settings dialog box.

The Agent Environment Settings dialog box is provided for compatibility with JP1/AJS2 whose version is 8 or earlier.

If you want to change the environment settings, we recommend that you use the `jajs_config` command. For details on the `jajs_config` command, see [jajs_config](#) in *2. Commands Used during Setup*.

Execution privileges

Administrators privileges

jqagtd

Format

```
jqagtd
  [-mh manager-host-name]
  -ah agent-host-name
  [-cp time-time=concurrently-executable-job-limit...]
```

Description

The `jqagtd` command adds an agent host to a manager host, and creates the default queue to which the agent host will connect.

Execution privileges

You must have the following JP1 privilege:

- JP1_JPQ_Admin privilege

Arguments

-mh *manager-host-name*

Specify the name of the manager host to which you want to add an agent host.

You can specify a character string of 1 to 255 bytes.

By default, the system assumes the local host name.

-ah *agent-host-name*

Specify the name of the agent host you want to add.

You can specify a character string of 1 to 255 bytes.

-cp *time-time=concurrently-executable-job-limit. . .*

Specify the period for concurrently-executable job limits, as well as the concurrently-executable job limit for the period.

Specifying the concurrently-executable job limit allows you to limit the number of jobs that can be concurrently executed by this agent host. The command applies to queue jobs and submit jobs only.

Once the specified concurrently-executable job limit is reached, any extra ones will be queued (for waiting for execution) until the job is completed.

Specify the period by time and time hyphenated. Specify the time in units of 30 minutes in the *hh:mm* format.

hh: You can specify 0, or 00 to 23 hours.

mm: You can specify 0, 00 or 30 minutes.

For the concurrently-executable job limit, you can specify 0 to 4,294,967,295.

By default, the system assumes the value of 00:00-00:00=0 (the 24-hour format with a limit value of 0).

If the maximum number of concurrently executable jobs is 0, you cannot execute the job. To execute the job, you must specify a value of 1 or larger or change the maximum number of concurrently executable jobs.

For an example of how to specify the maximum number of concurrently executable jobs, see also the *Additional information* for the `jpgagtalt` command.

You can specify multiple periods and numbers of concurrently-executable job limit. If you specify multiple periods, however, the values set later are reflected. (For example, if you set `-cp 1:00-2:30=5 2:00-4:00=10`, the number of concurrently-executable job limit for an overlapping period, 2:00 to 2:30 is 10.)

Notes

1. This command cannot be used for a request from JP1/AJS3 to JP1/OJE for VOS3.
2. If you omit the number of concurrently-executable jobs for a period, the default is 0. For example, the `-cp 10:00-22:00=10` expression alone means that the limit value is 0 for the 00:00 to 10:00 period, 10 for the 10:00 to 22:00 period, and 0 for the 22:00 to 00:00 period.
3. Executing more than one `jpgagtadd` command in parallel requires a considerably long time for processing. If you want to add multiple agent hosts, add them one after another.

Return values

| | |
|-----|---|
| 0 | Normal end |
| 1 | Invalid parameter value |
| 2 | An attempt to add an agent host failed due to an internal cause of the host on which the <code>jpgagtadd</code> command was executed. |
| 5 | Initialization has failed. <ul style="list-style-type: none"> • The definition of the logical host name or the environment setting contains an error. |
| 6 | Memory became insufficient on the host on which the <code>jpgagtadd</code> command was executed. |
| 7 | A logical error occurred on the host on which the <code>jpgagtadd</code> command was executed. |
| 100 | The host on which the <code>jpgagtadd</code> command was executed cannot connect to the manager host via TCP/IP communication. <ul style="list-style-type: none"> • The host on which the <code>jpgagtadd</code> command was executed cannot connect to the manager host because TCP/IP is not set up correctly. • The manager host name is invalid, or the manager host process stopped. |
| 102 | The IP address could not be resolved from the name of the manager host on which the <code>jpgagtadd</code> command was executed. |
| 200 | The manager host does not accept addition of an agent host. <ul style="list-style-type: none"> • The manager host is now being started, now being stopped, has stopped, or is running in the reduced-operation mode. |
| 202 | The manager host has returned no response. |
| 203 | Addition of an agent host failed due to an internal cause of the manager host. |
| 206 | Permission to add an agent host is not granted. |
| 219 | The manager host is busy. |
| 220 | The manager host memory is insufficient. |
| 222 | A fatal error has occurred. <ul style="list-style-type: none"> • A system call error has occurred. |
| 223 | The manager host encountered a logic error. |
| 224 | You have issued a request to a host other than JP1/AJS3. |
| 226 | Invalid execution environment |

| | |
|-----|---|
| 232 | An agent host with the same name as the agent host you attempted to add already exists. |
| 235 | The maximum number of agent host definitions has been exceeded. |
| 240 | The event/action control manager is changing the agent host configuration definition. |

Additional information

- The following table shows the attributes of the default queue created when an agent host is added, the initial values of these attributes, and the commands that can be used to change the attribute values.

| Items set for default queues | Attribute | Command used to change attribute |
|-----------------------------------|--|---|
| Concurrently-executable job limit | Value specified by the <code>-cp</code> option | <code>Jpqagtal</code> |
| Maximum number of jobs | 4,294,967,295 | <code>Jpqquealt</code> |
| Warning number of jobs | 4,294,967,295 | <code>Jpqquealt</code> |
| State of job reception port | close | <code>Jpqqueopen</code> |
| State of job takeout port | open | <code>Jpqqueclose</code> |
| Agent hosts to be connected | Agent host name specified by the <code>-ah</code> option | <code>jqagtunlink</code> , <code>jqagtlink</code> <code>jqagtlink</code> |
| Priority of agent hosts | 16 | <code>Jpqagtlink</code> |

- Immediately after you use the `jqagtadd` command to register agent hosts, you will not be able to register jobs because the queue entrance is closed. Use the `jqqueopen` command to open the default queue entrance. You should also make sure that any registered agent host name can be resolved to the IP address. If you want to register an agent host whose settings are the same as the default values of the agent host that was registered by using the `jqimport` command, use the following procedure:

- Add an agent host to the manager host, and set the maximum number of concurrently executable jobs (indicated as *concurrently-executable-job-limit* below).

The default value of `jqsetup.conf` is 24 hours, with 5 as the *concurrently-executable-job-limit*.

```
jqagtadd -ah agent-host-name -cp concurrently-executable-job-limit
```

- Open the default queue entrance.

```
jqqueopen -ah agent-host-name -en
```

- Change the *maximum-number-of-jobs* and the *warning-value-for-job-count* in a default queue.

By default, `jqsetup.conf` provides a maximum value of 100 for the number of jobs and a warning value of 80 for the number of jobs.

```
jqquealt -ah agent-host-name -mj maximum-number-of-jobs -wj warning-value-for-job-count
```

- Change the priority of agent hosts to be connected.

By default, `jqsetup.conf` provides a value of 1 for priority.

```
jqagtlink -ah agent-host-name -lh agent-host-name -clp connection-destination-agent-host-priority
```

Note that agent IDs are automatically assigned when you use the `jqagtadd` command to register agent hosts. If you want to explicitly specify agent IDs, use the `jqimport` command to register agent hosts.

jqagtal

Format

```
jqagtal
  [-mh manager-host-name]
  -ah agent-host-name
  -cp time-time=concurrently-executable-job-limit...
  [-em]
```

Description

The `jqagtal` command changes the maximum number of jobs that can concurrently be executed on an agent host registered in the manager host.

Execution privileges

You must have the following JP1 privilege:

- JP1_JPQ_Admin privilege

However, specifying the `-em` option requires the following privileges (but does not require JP1_JPQ_Admin privileges).

- Windows: Administrators privileges
- UNIX: Superuser privileges

Arguments

-mh *manager-host-name*

When you want to change the maximum number of concurrently executable jobs on an agent host, specify the name of the manager host on which the agent host has been registered.

You can specify a character string of 1 to 255 bytes.

By default, the system assumes the local host name.

When you specify this option together with the `-em` option, you can specify only two types of host names: the local host name and the logical host name on the local host. Specifying any other value results in an error (error code: 25). Also note that you cannot specify an alias host name in the `-mh` option.

-ah *agent-host-name*

Specify the name of the agent host for which the number of concurrently-executable job limit is to be changed.

You can specify a character string of 1 to 255 bytes.

-cp *time-time=number-of-concurrently-executable-job-limit*

Specify the period in which to change the number of concurrently executable job limit and specify the number of concurrently-executable job limit.

Specifying the concurrently-executable job limit allows you to limit the number of jobs that can be concurrently executed by this agent host. The command applies to queue jobs and submit jobs only.

Once the specified concurrently-executable job limit is reached, any extra ones will be queued (for waiting for execution) until the job is completed.

Specify the period by time and time hyphenated. Specify the time in units of 30 minutes in the *hh:mm* format.

hh: You can specify 0, or 00 to 23 hours.

mm: You can specify 0, 00 or 30 minutes.

For the number of concurrently-executable job limit, you can specify 0 to 4,294,967,295.

If the specified period contains the time when you execute the command, the number of concurrently-executable job limit is changed immediately.

You can specify multiple periods and numbers of concurrently-executable job limit. If you specify multiple periods, however, the values set later are reflected. (For example, if you set `-cp 1:00-2:30=5 2:00-4:00=10`, the number of concurrently-executable job limit for an overlapping period, 2:00 to 2:30 is 10.)

See [Additional information](#) covering examples of specifying the number of concurrently-executable job limit. Reference it as necessary.

-em

Specify this option for emergency execution.

Specifying this option enables emergency execution upon failure because a request is sent to a different communication path that is not used under normal conditions.

When you specify this option, note that you cannot assign an IP address to the manager host name.

Notes

1. This command cannot be used for a request from JP1/AJS3 to JP1/OJE for VOS3.
2. The concurrently-executable job limit specified by this command does not include concurrently-executable event job and custom event job limit.
3. If you omit the number of concurrently-executable jobs for a period, the default is 0. For example, the `-cp 10:00-22:00=10` expression alone means that the limit value is 0 for the 00:00 to 10:00 period, 10 for the 10:00 to 22:00 period, and 0 for the 22:00 to 00:00 period.
4. You should use the `-em` option for the sole purpose of recovering from an agent host failure. You should avoid specifying the `-em` option under any normal condition, because you may fail to take corrective action when a failure actually occurs.

Return values

| | |
|---|---|
| 0 | Normal end |
| 1 | Invalid parameter value |
| 2 | An attempt to change the maximum number of concurrently executable jobs failed due to an internal cause of the host on which the <code>jpgagtalt</code> command was executed. |
| 5 | Initialization has failed. <ul style="list-style-type: none">• The definition of the logical host name or the environment setting contains an error. |
| 6 | Memory became insufficient on the host on which the <code>jpgagtalt</code> command was executed. |
| 7 | A logical error occurred on the host on which the <code>jpgagtalt</code> command was executed. |

| | |
|-----|---|
| 25 | The specified manager host name is neither the local host name nor the logical host name. |
| 100 | The host on which the <code>jpgagtalt</code> command was executed cannot connect to the manager host via TCP/IP communication. <ul style="list-style-type: none"> The host on which the <code>jpgagtalt</code> command was executed cannot connect to the manager host because TCP/IP is not set up correctly. The manager host name is invalid, or the manager host process stopped. |
| 102 | The IP address could not be resolved from the name of the manager host on which the <code>jpgagtalt</code> command was executed. |
| 200 | The manager host does not accept changes to the number of concurrently-executable job limit. <ul style="list-style-type: none"> The manager host is now being started, now being stopped, has stopped, or is running in the reduced-operation mode. |
| 201 | You cannot use a specified agent host. <ul style="list-style-type: none"> The specified agent host is not found. |
| 202 | The manager host has returned no response. |
| 203 | The number of concurrently-executable job limit could not be changed successfully owing to an internal cause of the manager host. |
| 206 | You do not have the privilege required to change the number of concurrently-executable job limit. |
| 219 | The manager host is busy. |
| 220 | The manager host memory is insufficient. |
| 222 | A fatal error has occurred. <ul style="list-style-type: none"> A system call error has occurred. |
| 223 | The manager host encountered a logic error. |
| 224 | You have issued a request to a host other than JP1/AJS3. |
| 226 | Invalid execution environment |

Additional information

The following gives examples of specifying the number of concurrently-executable job limit.

- The following command changes the number of concurrently-executable job limit of 1:00 to 5:00 to 1.

```
-cp 01:00-05:00=1
```

- The following command changes the number of concurrently-executable job limit of 23:00 to 24:00 to 1.

```
-cp 23:00-00:00=1
```

Specify 24:00 as 00:00 or 0:0.

- The following command changes the number of concurrently-executable job limit of 23:00 to 24:00 and 00:00 to 05:00 on the next day to 1.

```
-cp 23:00-05:00=1
```

You can give a two-day expression to the number of concurrently-executable job limit.

- The following command changes the number of concurrently-executable job limit of one day to 1.

```
-cp 00:00-00:00=1
```

jqagtdel

Format

```
jqagtdel
  [-mh manager-host-name]
  -ah agent-host-name
```

Description

The `jqagtdel` command deletes an agent host from a manager host, and deletes the default queue to which the agent host is connected.

Execution privileges

You must have the following JP1 privilege:

- JP1_JPQ_Admin privilege

Arguments

-mh *manager-host-name*

Specify the name of the manager host from which you want to delete an agent host.

You can specify a character string of 1 to 255 bytes.

By default, the system assumes the local host name.

-ah *agent-host-name*

Specify a agent host name you want to delete.

You can specify a character string of 1 to 255 bytes.

Notes

1. This command cannot be used for a request from JP1/AJS3 to JP1/OJE for VOS3.
2. Before executing this command, you must make the following preparations:
 - Use `jqqueclose` or a similar command to close the entrance of the default queue to which the agent host you want to delete is connected. Then make sure that no jobs are running and no jobs are contained in the default queue.
You cannot delete the agent host if it has a job that is being executed, assuming that the job is a standard job (PC, UNIX, or QUEUE), custom job, action job, event job, or custom event job.
When the default queue that contains jobs is deleted, any jobs whose status is *Waiting to execute*, *Being held*, or *Waiting for time* are forcibly terminated.
 - Use `jqagtunlink` or a similar command to disconnect all queues (other than the default queue) from the agent host you want to delete.
You cannot delete an agent host if it is connected to any queue other than the default queue.
 - Executing more than one `jqagtdel` command in parallel requires a considerably long time for processing.
When deleting multiple agent hosts, delete them one by one.

3. If an event job, a custom event job or a jobnet with start conditions is executed on an agent host already deleted by the `jpqagt del` command, the manager host name that was specified in the `-mh` option of the command has been retained on the agent host. On the agent host, delete the manager host specified in the `-mh` option of the command. The procedure is as follows.

1. Check whether the manager host name specified in the `-mh` option of the `jpqagt del` command has been retained on the agent host.

Execute the following command:

```
jpagoec -p
```

2. Delete the manager host name specified in the `-mh` option.

Execute the following command:

```
jpagoec -d manager-host-name-specified-in-the-mh-option
```

This prevents unnecessary communication (start or stop notification) to the manager host when the agent host is started or stopped. For details on the `jpagoec` command, see *jpagoec* in 3. *Commands Used for Normal Operations* earlier in this chapter.

4. If an event job, a custom event job or a jobnet with start conditions is being executed on an agent host, do not stop the OS or turn off the machine before you stop the JP1/AJS3 service on the agent host. If you do so, the `jpqagt del` command will not be able to delete the agent. If the command has become unable to delete the agent, stop the JP1/AJS3 service on the manager host, cold-start the host, and then re-execute the command. Alternatively, delete the information about an event job, a custom event job or a jobnet with start conditions being executed on the agent host, and then re-execute the command.

The following describes the procedure for deleting information about an event job, a custom event job or a job with start conditions being executed on an agent host.

1. Stop the JP1/AJS3 service on the manager host.

2. On the manager host, make sure that an event job or a custom event job is being executed or a jobnet with start conditions is being monitored on the agent host.

Execute the following command:

```
jpomanjobshow -h manager-host-name -a name-of-agent-host-to-delete
```

3. On the manager host, delete information about the event job or the custom event job being executed or the jobnet with start conditions being monitored on the agent host.

Execute the following command:

```
jpomanevreset -h manager-host-name -a agent-host-name -s
```

For details on the `jpomanjobshow` command, see *jpomanjobshow* in 3. *Commands Used for Normal Operations*.

For details on the `jpomanevreset` command, see *jpomanevreset* in 3. *Commands Used for Normal Operations*.

Return values

| | |
|-----|--|
| 0 | Normal end |
| 1 | Invalid parameter value |
| 2 | An attempt to delete an agent host failed due to an internal cause of the host on which the <code>jpqagt del</code> command was executed. |
| 5 | Initialization has failed. <ul style="list-style-type: none"> The definition of the logical host name or the environment setting contains an error. |
| 6 | Memory became insufficient on the host on which the <code>jpqagt del</code> command was executed. |
| 7 | A logical error occurred on the host on which the <code>jpqagt del</code> command was executed. |
| 100 | The host on which the <code>jpqagt del</code> command was executed cannot connect to the manager host via TCP/IP communication. |

| | |
|-----|---|
| 100 | <ul style="list-style-type: none"> The host on which the <code>jpqagt del</code> command was executed cannot connect to the manager host because TCP/IP is not set up correctly. The manager host name is invalid, or the manager host process stopped. |
| 102 | The IP address could not be resolved from the name of the manager host on which the <code>jpqagt del</code> command was executed. |
| 200 | <p>The manager host does not accept the agent host deleting request.</p> <ul style="list-style-type: none"> The manager host is now being started, now being stopped, has stopped, or is running in the reduced-operation mode. |
| 202 | The manager host has returned no response. |
| 203 | The agent host could not be deleted successfully owing to an internal cause of the manager host. |
| 206 | You do not have the privilege required to delete the agent host. |
| 214 | There is no agent host connected to the manager host. |
| 219 | The manager host is busy. |
| 220 | The manager host memory is insufficient. |
| 222 | <p>A fatal error has occurred.</p> <ul style="list-style-type: none"> A system call error has occurred. |
| 223 | The manager host encountered a logic error. |
| 224 | You have issued a request to a host other than JP1/AJS3. |
| 226 | Invalid execution environment |
| 233 | There is a job being executed, which is a standard job, custom job, or action job. |
| 234 | There is a job being executed, which is an event job or a custom event job. |
| 236 | The agent host is connected to a queue. |
| 240 | The event/action control manager is changing the agent host configuration definition. |

jpqagtlink

Format

```
jpqagtlink
  [-mh manager-host-name]
  {-q queue-name|-ah agent-host-name}
  -lh name-of-the-agent-host-to-be-connected
  {[-lp connection-priority-for-an-agent-host-that-has-not-been-connected]
  |
  |   -clp connection-priority-for-an-agent-host-that-has-been-connected
  }
  [-em]
```

Description

The `jpqagtlink` command is used to connect an agent host to a queue. The command is also used to set the priority of an agent host to be connected to a queue.

Execution privileges

You must have the following JP1 privilege:

- JP1_JPQ_Admin privilege

However, specifying the `-em` option requires the following privileges (but does not require JP1_JPQ_Admin privileges).

- Windows: Administrators privileges
- UNIX: Superuser privileges

Arguments

`-mh` *manager-host-name*

When you want to connect an agent host to a queue, specify the name of the manager host on which the queue has been created. Alternatively, when you want to set the priority of an agent that has been connected to a queue, specify the name of the manager host on which the queue has been created.

You can specify a character string of 1 to 255 bytes.

By default, the system assumes the local host name.

When you specify this option together with the `-em` option, you can specify only two types of host names: the local host name and the logical host name on the local host. Specifying any other value results in an error (error code: 25). Also note that you cannot specify an alias host name in the `-mh` option.

`-q` *queue-name*

When you want to connect an agent host to a queue other than the default queue, specify the name of the queue. Alternatively, when you want to set the priority of an agent that has been connected to a queue, specify the name of the queue.

You can specify a character string of 1 to 63 bytes.

-ah agent-host-name

When you want to connect an agent host to the default queue, specify the agent host name (default queue name) registered on the manager host when the default queue was created. Alternatively, when you want to change the priority of the agent host that has been connected to the default queue, specify the agent host name (default queue name) registered on the manager host when the default queue was created.

You can specify a character string of 1 to 255 bytes.

-lh name-of-the-agent-host-to-be-connected

Specify the name of the agent you want to connect to the specified queue or the name of the agent host for which you want to set the priority.

You can specify a character string of 1 to 255 bytes.

-lp connection-priority-for-an-agent-host-that-has-not-been-connected

Specify the priority of destination agent hosts.

You can specify a value between 1 and 16. The lowest priority is 1 and the highest is 16. Jobs with higher levels of priority are given execution precedence.

If you omit this option, the system assumes 16.

Use this option to set the queue connection priority for an agent host (specified by the `-lh` option) that has not been connected to a queue (specified by the `-q` option) or the default queue (specified by the `-ah` option).

-clp connection-priority-for-an-agent-host-that-has-been-connected

Specify the priority of destination agent hosts.

You can specify a value between 1 and 16. The lowest priority is 1 and the highest is 16. Jobs with higher levels of priority are given execution precedence.

Use this option to change the queue connection priority for an agent host (specified by the `-lh` option) that has been connected to a queue (specified by the `-q` option) or the default queue (specified by the `-ah` option).

-em

Specify this option for emergency execution.

Specifying this option enables emergency execution upon failure because a request is sent to a different communication path that is not used under normal conditions.

When you specify this option, note that you cannot assign an IP address to the manager host name.

Notes

1. This command cannot be used for a request from JP1/AJS3 to JP1/OJE for VOS3.
2. You should use the `-em` option for the sole purpose of recovering from an agent host failure. You should avoid specifying the `-em` option under any normal condition, because you may fail to take corrective action when a failure actually occurs.

Return values

| | |
|---|------------|
| 0 | Normal end |
|---|------------|

| | |
|-----|---|
| 1 | Invalid parameter value |
| 2 | An attempt to connect an agent host or change the connection priority failed due to an internal cause of the host on which the <code>jpgagtlink</code> command was executed. |
| 5 | Initialization has failed. <ul style="list-style-type: none"> The definition of the logical host name or the environment setting contains an error. |
| 6 | Memory became insufficient on the host on which the <code>jpgagtlink</code> command was executed. |
| 7 | A logical error occurred on the host on which the <code>jpgagtlink</code> command was executed. |
| 25 | The specified manager host name is neither the local host name nor the logical host name. |
| 100 | The host on which the <code>jpgagtlink</code> command was executed cannot connect to the manager host via TCP/IP communication. <ul style="list-style-type: none"> The host on which the <code>jpgagtlink</code> command was executed cannot connect to the manager host because TCP/IP is not set up correctly. The manager host name is invalid, or the manager host process stopped. |
| 102 | The IP address could not be resolved from the name of the manager host on which the <code>jpgagtlink</code> command was executed. |
| 200 | The manager host does not accept connection to the agent host or changes of its priority. <ul style="list-style-type: none"> The manager host is now being started, now being stopped, has stopped, or is running in the reduced-operation mode. |
| 201 | You cannot use a specified queue. <ul style="list-style-type: none"> The specified queue is not found. The specified default queue does not exist. |
| 202 | The manager host has returned no response. |
| 203 | The agent host could not be connected or its priority could not change successfully owing to an internal cause of the manager host. |
| 206 | You do not have the privilege required to connect the agent host or change its priority. |
| 214 | There is no agent host connected to the manager host. |
| 219 | The manager host is busy. |
| 220 | The manager host memory is insufficient. |
| 222 | A fatal error has occurred. <ul style="list-style-type: none"> A system call error has occurred. |
| 223 | The manager host encountered a logic error. |
| 224 | You have issued a request to a host other than JP1/AJS3. |
| 226 | Invalid execution environment |
| 232 | An attempt has been made to connect to connected agent hosts. |
| 239 | An attempt has been made to change the priority of non-connected agent hosts by means of the <code>-clp</code> option. |

jqagtsow

Format

```
jqagtsow  
  [-mh manager-host-name]  
  {-ah agent-host-name | -a | -n}  
  [-em]
```

Description

Outputs agent host information (including the agent host name and the schedule of the number of concurrently-executable job limit of a day) to the standard output file.

Execution privileges

You must have the following JP1 privilege:

- JP1_JPQ_Admin privilege

However, specifying the `-em` option requires the following privileges (but does not require JP1_JPQ_Admin privileges).

- Windows: Administrators privileges
- UNIX: Superuser privileges

Arguments

`-mh` *manager-host-name*

When you want to output information about an agent host, specify the name of the manager host on which the agent host has been registered.

You can specify a character string of 1 to 255 bytes.

By default, the system assumes the local host name.

When you specify this option together with the `-em` option, you can specify only two types of host names: the local host name and the logical host name on the local host. Specifying any other value results in an error (error code: 25). Also note that you cannot specify an alias host name in the `-mh` option.

`-ah` *agent-host-name*

Specify the name of the agent host whose agent host information is to be output.

You can specify a character string of 1 to 255 bytes.

`-a`

Outputs information about all the agent hosts registered to the manager host set by the `-mh` option.

`-n`

Outputs the names of all the agent hosts registered to the manager set by the `-mh` option.

-em

Specify this option for emergency execution.

Specifying this option enables emergency execution upon failure because a request is sent to a different communication path that is not used under normal conditions.

When you specify this option, note that you cannot assign an IP address to the manager host name.

Notes

1. This command cannot be used for a request from JP1/AJS3 to JP1/OJE for VOS3.
2. For the `-a` option, up to 57 bytes can be output as the agent host name. If the agent host name exceeds 57 bytes, the 56th and subsequent bytes become ". .".
3. You should use the `-em` option for the sole purpose of recovering from an agent host failure. You should avoid specifying the `-em` option under any normal condition, because you may fail to take corrective action when a failure actually occurs.

Return values

| | |
|-----|--|
| 0 | Normal end |
| 1 | Invalid parameter value |
| 2 | An attempt to output agent host information failed due to an internal cause of the host on which the <code>jpgagtshow</code> command was executed. |
| 5 | Initialization has failed. <ul style="list-style-type: none">• The definition of the logical host name or the environment setting contains an error. |
| 6 | Memory became insufficient on the host on which the <code>jpgagtshow</code> command was executed. |
| 7 | A logical error occurred on the host on which the <code>jpgagtshow</code> command was executed. |
| 25 | The specified manager host name is neither the local host name nor the logical host name. |
| 100 | The host on which the <code>jpgagtshow</code> command was executed cannot connect to the manager host via TCP/IP communication. <ul style="list-style-type: none">• The host on which the <code>jpgagtshow</code> command was executed cannot connect to the manager host because TCP/IP is not set up correctly.• The manager host name is invalid, or the manager host process stopped. |
| 102 | The IP address could not be resolved from the name of the manager host on which the <code>jpgagtshow</code> command was executed. |
| 200 | The manager host does not accept output agent host information. <ul style="list-style-type: none">• The manager host is now being started, now being stopped, has stopped, or is running in the reduced-operation mode. |
| 201 | You cannot use a specified agent host. <ul style="list-style-type: none">• The specified agent host is not found. |
| 202 | The manager host has returned no response. |
| 203 | Agent host information could not be output successfully owing to an internal cause of the manager host. |
| 206 | You do not have the privilege required to output agent host information. You do not have the privilege required to output the agent host name. |
| 212 | The attempt to output information about the agent host has failed because an agent host is currently being added or changed. |
| 214 | No agent host is connected to the manager host. |
| 219 | The manager host is busy. |

| | |
|-----|---|
| 220 | The manager host memory is insufficient. |
| 222 | A fatal error has occurred. <ul style="list-style-type: none"> • A system call error has occurred. |
| 223 | The manager host encountered a logic error. |
| 224 | You have issued a request to a host other than JP1/AJS3. |
| 226 | Invalid execution environment |

Output example 1

The following gives an example of file output when you specify the `-ah` option, and describes the meanings of output contents.

```
AGENT : agent1.aaaa.bbbb.cccc.dddd.eeee.ffff.gggg.hhhh.iiii.jjjj.kkkk.l111.softw
are.hitachi.co.jp
CUREXECHGNUM : 2
EXECUTING : 1
CHANGEPOINT : 00:00-00:30 (5) 00:30-07:30 (8)
CHANGEPOINT : 07:30-20:00 (0) 20:00-00:00 (4)
```

The following shows the meaning of the output.

AGENT

Indicates an agent host name.

CUREXECHGNUM

Indicates the current number of concurrently-executable job limit.

EXECUTING

Indicates the number of jobs being executed.

CHANGEPOINT

Indicates the schedule of the number of the concurrently-executable job limit on a day in the format of *multiplicity-setup-start-time - multiplicity-setup-end-time (number-of-concurrently-executable-job-limit)*.

Output example 2

The following gives an example of file output when you specify the `-a` option, and describes the meanings of output contents.

| AGENT | CUREXECHG | EXECUTING |
|--|-----------|-----------|
| agent1.aaaa.bbbb.cccc.dddd.eeee.ffff.gggg.hhhh.iiii.jjjj.. | 2 | 1 |
| agent2 | 5 | 0 |

The following shows the meaning of the output.

AGENT

Indicates an agent host name.

57 bytes of data are output.

CUREXECHG

Indicates the current number of concurrently-executable job limit.

EXECUTING

Indicates the number of jobs being executed.

Output example 3

The following gives an example of file output when you specify the `-n` option, and describes the meanings of output contents.

```
AGENT
-----
agent1.aaaa.bbbb.cccc.dddd.eeee.ffff.gggg.hhhh.iiii.jjjj.kkkk.l111.software.hitach
i.co.jp
agent2
```

The following shows the meaning of the output.

AGENT

Indicates an agent host name.

jpqagtunlink

Format

```
jpqagtunlink
  [-mh manager-host-name]
  {-q queue-name|-ah agent-host-name}
  -lh name-of-the-host-to-be-disconnected
```

Description

Cancels the connection between the queue and its agent hosts.

Execution privileges

You must have the following JP1 privilege:

- JP1_JPQ_Admin privilege

Arguments

-mh *manager-host-name*

Specify the name of the manager host that contains the queue whose agent host connection you want to cancel.

You can specify a character string of 1 to 255 bytes.

By default, the system assumes the local host name.

-q *queue-name*

When you want to disconnect an agent host from a queue (other than the default queue), specify the name of the queue.

You can specify a character string of 1 to 63 bytes.

-ah *agent-host-name*

When you want to disconnect an agent host from the default queue, specify the agent host name (default queue name) registered on the manager host when the default queue was created.

You can specify a character string of 1 to 255 bytes.

-lh *name-of-the-host-to-be-disconnected*

Specify the name of the agent host whose connection you want to cancel.

You can specify a character string of 1 to 255 bytes.

Notes

1. This command cannot be used for a request from JP1/AJS3 to JP1/OJE for VOS3.
2. An attempt to disconnect any non-connected agent host results in an error.
3. You cannot disconnect the agent host if it has a job that is being executed, assuming that the job is a QUEUE job or submit job.

Return values

| | |
|-----|--|
| 0 | Normal end |
| 1 | Invalid parameter value |
| 2 | An attempt to disconnect an agent host failed due to an internal cause of the host on which the <code>jpgagtunlink</code> command was executed. |
| 5 | Initialization has failed. <ul style="list-style-type: none">The definition of the logical host name or the environment setting contains an error. |
| 6 | Memory became insufficient on the host on which the <code>jpgagtunlink</code> command was executed. |
| 7 | A logical error occurred on the host on which the <code>jpgagtunlink</code> command was executed. |
| 100 | The host on which the <code>jpgagtunlink</code> command was executed cannot connect to the manager host via TCP/IP communication. <ul style="list-style-type: none">The host on which the <code>jpgagtunlink</code> command was executed cannot connect to the manager host because TCP/IP is not set up correctly.The manager host name is invalid, or the manager host process stopped. |
| 102 | The IP address could not be resolved from the name of the manager host on which the <code>jpgagtunlink</code> command was executed. |
| 200 | The manager host does not accept disconnecting the agent host. <ul style="list-style-type: none">The manager host is now being started, now being stopped, has stopped, or is running in the reduced-operation mode. |
| 201 | You cannot use a specified queue. <ul style="list-style-type: none">The specified queue is not found.The specified default queue does not exist. |
| 202 | The manager host has returned no response. |
| 203 | The agent host could not be disconnected successfully owing to an internal cause of the manager host. |
| 206 | You do not have the privilege required to disconnect the agent host. |
| 214 | There is no agent host connected to the manager host. |
| 219 | The manager host is busy. |
| 220 | Memory shortage has occurred on the request side of the manager host. |
| 222 | A fatal error has occurred. <ul style="list-style-type: none">A system call has encountered an error. |
| 223 | The manager host encountered a logic error. |
| 224 | You have issued a request to a host other than JP1/AJS3. |
| 226 | Invalid execution environment |
| 232 | There is no agent host connection. |
| 233 | There is a job being executed, which is a QUEUE job or submit job. |

jpqendjobshow

Format

```
jpqendjobshow
  [-mh manager-host-name]
  [-u owner-name]
  [-sa time]
  [-sp time]
  [-rn output-job-information-count]
  [-qn]
```

Description

Outputs a list of ended job information (including the job number and submittal destination queue name) to the standard output.

You can also output ended job information about the JP1/OJE for VOS3 hosts.

You can also output ended job information about the AS/400 system.

This command is applicable for the following jobs:

When the database is in a standard configuration:

Submit jobs and queue jobs

When the database is in a standard configuration without ISAM:

None

Execution privileges

You must have any of the following JP1 privileges:

- JP1_JPQ_Admin privilege
- JP1_JPQ_Operator privilege
- JP1_JPQ_User privilege (allows you to manipulate only the jobs you own)

Arguments

-mh *manager-host-name*

Specify the name of the manager host to which you have submitted a job whose job information is to be output.

You can specify a character string of 1 to 255 bytes.

By default, the system assumes the local host name.

-u *owner-name*

Specify the job owner name.

You can specify a character string of 1 to 63 bytes. By default, the system assumes all the users if a user having the JP1_JPQ_Admin privilege or JP1_JPQ_Operator privilege executes the command. If a user having the JP1_JPQ_User privilege executes the command, the system assumes that user.

-sa time

If you want to output information about jobs whose execution ended after a specific time, specify the time based on the time of the host on which the command is executed. The format of the time you specify is *YYYY/MM/DD .hh:mm:ss*. You can specify a time between 1980/01/01.00:00:00 and 2038/01/18.03:14:07. By default, the system assumes the time for the oldest job information.

- *YYYY*
Specify a year. You can specify 1980 to 2038.
- *MM*
Specify a month. You can specify 01 to 12.
- *DD*
Specify a day. You can specify 01 to 31.
- *hh*
Specify hours. You can specify 00 to 23.
- *mm*
Specify minutes. You can specify 00 to 59.
- *ss*
Specify seconds. You can specify 00 to 59.

-sp time

If you want to output information about jobs whose execution ended before a specific time, specify the time based on the local time of the host on which the command is executed. The format of the time you specify is *YYYY/MM/DD .hh:mm:ss*. You can specify a time between 1980/01/01.00:00:00 and 2038/01/18.03:14:07. By default, the system assumes the time for the oldest job information.

- *YYYY*
Specify a year. You can specify 1980 to 2038.
- *MM*
Specify a month. You can specify 01 to 12.
- *DD*
Specify a day. You can specify 01 to 31.
- *hh*
Specify hours. You can specify 00 to 23.
- *mm*
Specify minutes. You can specify 00 to 59.
- *ss*
Specify seconds. You can specify 00 to 59.

-rn output-job-information-count

Specify the number of pieces of job information to be output. (The system outputs the number of pieces of job information specified with this option, among the end job information in the range specified with the *-sa* and *-sp* options, starting from information about the job for which the end time is the latest.)

You can specify a value between 0 and 4,294,967,295. If you omit this option, the system assumes 0.

If you set 0, the system outputs all the job information in the manager host set by the *-mh* option.

-qn

Outputs the job number, and queue type, and name as job information.

Note

The number of bytes which can be output is fixed for each output item. If the contents of an output item exceed the output limit, they end with ". .". (For example, the job name output limit is 26 bytes. If the job name exceeds 26 bytes, the 25th and subsequent bytes become ". .".) For the queue name that can be output by the `-qn` option, all the contents are output.

To output all the contents on each output item, use the `jspqjobget` command.

Return values

| | |
|-----|--|
| 0 | Normal end |
| 1 | Invalid parameter value |
| 2 | An attempt to output information about ended jobs failed due to an internal cause of the host on which the <code>jspqendjobshow</code> command was executed. |
| 5 | Initialization has failed. <ul style="list-style-type: none">The definition of the logical host name or the environment setting contains an error. |
| 6 | Memory became insufficient on the host on which the <code>jspqendjobshow</code> command was executed. |
| 7 | A logical error occurred on the host on which the <code>jspqendjobshow</code> command was executed. |
| 100 | The host on which the <code>jspqendjobshow</code> command was executed cannot connect to the manager host via TCP/IP communication. <ul style="list-style-type: none">The host on which the <code>jspqendjobshow</code> command was executed cannot connect to the manager host because TCP/IP is not set up correctly.The manager host name is invalid, or the manager host process stopped. |
| 102 | The IP address could not be resolved from the name of the manager host on which the <code>jspqendjobshow</code> command was executed. |
| 200 | The manager host does not accept ended job information output. <ul style="list-style-type: none">The manager host is now being started, now being stopped, has stopped, or is running in the reduced-operation mode. |
| 202 | The manager host has returned no response. |
| 203 | Ended job information could not be output successfully owing to an internal cause of the manager host. |
| 206 | You do not have the privilege required to output ended job information. |
| 207 | The specified job is not found. <ul style="list-style-type: none">The specified job is not in the database.Specified ended job information has been deleted.Because the specified user's job cannot be accessed, ended job information cannot be output. |
| 219 | The manager host is busy. |
| 222 | A fatal error has occurred. <ul style="list-style-type: none">A system call error has occurred. |
| 223 | The manager host encountered a logic error. |
| 224 | You have issued an end job information output request to an unsupported host. |
| 226 | Invalid execution environment |

Output example 1

The following gives an example of file output when you specify the `-qn` option, and describes the meanings of output contents.

| JOBID | T | QUEUE |
|-------|---|---|
| 1 | q | queue1 |
| 2 | a | agentnamelongname.long1.long2.long3.long4.long5.long6.software.hitach hi.co.jp |
| 4 | q | queue1 |
| 5 | a | agent01 |

The following gives the meanings of output contents.

JOBID

Indicates a job number.

T

Indicates a queue type.

- q: Queue
- a: Agent host

QUEUE

Indicates a queue name (or an agent host name).

Output example 2

The following gives an example of file output when you do not specify the `-qn` option, and describes the meanings of output contents.

| JOBID | JOBNAME | T | QUEUE | EXITCODE |
|-------|-------------------------------|---|-----------------------------|----------|
| 1 | jobnamelonglonglonglongmgn... | q | queue1 | 0 |
| 2 | job2 | a | agentnamelongname.long1.1.. | 1 |
| 4 | job4 | q | queue1 | 0 |
| 5 | job5 | a | agent01 | 2 |

The following shows the meaning of the output.

JOBID

Indicates a job number.

JOBNAME

Indicates a job name.

26 bytes of data are output.

When you use a `QUEUE job` or the `jpqjobs sub` command to specify a job name, that job name is set. If no job name is specified, the execution file name is set.

When you define a PC job in a jobnet, the execution file name is set. When you define a Unix job in a jobnet, the script file name is set. If you do not specify a script file name, and then define a job name in a command statement, `script_job` is set as the job name.

For an action job, the name of the fixed execution file executed by each action job is set as the job name. For an execution file name, the first 63 bytes of the characters from the beginning of the file name, excluding the path information, are set as the job name, and the first 26 bytes are displayed.

T

Indicates a queue type.

- q: Queue
- a: Agent host

QUEUE

Indicates a queue name (or an agent host name).

27 bytes of data are output.

EXITCODE

Indicates a return code (including symbols).

jqexport

Format

```
jqexport
  -dt isam
  -co file-name
  [-mh logical-host-name]
  [-dp name-of-database-storage-directory]
```

Description

Outputs the current job execution environment (job execution agent, queues, and execution-locked resources) to a file.

Execution privileges

In Windows: Administrators privileges

In UNIX: Superuser privileges

Arguments

-dt isam

Specify the type of the database used in the job execution environment.

- *isam*
ISAM-based database

-co *file-name*

Specify, using the absolute path name, the file to which the job execution environment is to be output.

You can specify 1 to 511 characters (bytes).

-mh *logical-host-name*

Specify the logical host name.

You can specify 1 to 255 characters (bytes).

If you omit this option, the system assumes the physical host name.

Specify this option first.

-dp *name-of-database-storage-directory*

Specify the name of the directory that contains the ISAM files used as the database in the job execution environment.

You can specify 1 to 511 characters (bytes).

If you omit this option, the system assumes the directory name defined as the database storage directory for the job execution environment during environment setup (configuration).

Notes

1. You cannot overwrite a file to which the job execution environment is to be output. Delete or save files before outputting the job execution environment to the file.
2. Depending on the job execution environment to be used, it may take several minutes or more to output the job execution environment to a file.
3. If you omit the `-mh` option, the system does not reference environment variable `JP1_HOSTNAME`. For operation on the logical host, do not omit the `-mh` option.
4. Do not execute this command and `jajs_maintain -m manager` at the same time.

Return values

| | |
|-----|--|
| 0 | Normal end |
| 1 | The specified argument is invalid. |
| 130 | The specified file or its path is not found. |
| 131 | The specified file has already been created. |
| 133 | You do not have the privilege (are not authorized) to access the specified file. |
| 135 | The database is missing or there are insufficient system resources. |
| 137 | The database storage directory is missing. |
| 138 | You do not have the privilege (are not authorized) to access the database. |
| 140 | You do not have Administrator privileges (in Windows) or superuser privileges (in UNIX) to output the job execution environment. |
| 141 | Environment settings or the logical host name is inappropriate. |
| 145 | There is insufficient memory. |
| 146 | Free disk space is insufficient. |
| 147 | An internal factor error occurred. |
| 149 | The system cannot perform processing because the database size exceeds 2 gigabytes. |
| 150 | The database cannot be connected. |

jpqimport

Format

```
jpqimport
  -dt isam
  -ci name-of-configuration-definition-file-for-submit-job-execution-environment
  [-mh logical-host-name]
  [-dp name-of-database-storage-directory]
```

Description

Collectively defines the job execution environment (job execution agent, queues, and execution-locked resources) using the configuration definition file for the submit job execution environment (`jpqsetup.conf`).

If you want to execute a job on another host agent, you must define the job execution agent in the job execution environment.

In addition, you must create queues in the following cases:

- When you want to use purpose-specific queues to accept jobs registered (submitted) from clients
- When you want to distribute execution of jobs
- When you want to accept jobs from JP1/OJE for VOS3

Execution privileges

In Windows: Administrators privileges

In UNIX: Superuser privileges

Arguments

-dt isam

Specify the type of the database used in the job execution environment.

- `isam`
ISAM-based database

-ci *name-of-configuration-definition-file-for-submit-job-execution-environment*

Specify the name of the configuration definition file for submit job execution environment (`jpqsetup.conf`) to be used.

You can specify 1 to 511 characters (bytes).

If you specify only the file name (`jpqsetup.conf`) for the `-ci` option, it is assumed that the file (`jpqsetup.conf`) exists in the current directory when the command is executed. Therefore, if the file (`jpqsetup.conf`) does not actually exist in the current directory, the command will end in an error.

To execute the command regardless of whether the file `jpqsetup.conf` exists in the current directory, specify the full path of the file `jpqsetup.conf` for the `-ci` option.

For details on how to define the configuration definition file for the submit job execution environment, see *Defining the configuration definition file for the submit job execution environment (jppqsetup.conf)*, below.

-mh *logical-host-name*

Specify the logical host name.

You can specify 1 to 255 characters (bytes).

If you omit this option, the system assumes the physical host name.

Specify this option first.

-dp *name-of-database-storage-directory*

Specify the name of the directory that will contain the ISAM files used as the database in the job execution environment.

You can specify 1 to 511 characters (bytes).

If you omit this option, the system assumes the directory name defined as the database storage directory for the job execution environment during environment setting (configuration).

Notes

1. The job execution environment collectively defined by using this command is used for QUEUE jobs and submit jobs. Further, job execution environment settings are not used by queueless jobs.
2. If this command is used to define all execution environment settings for submit jobs at one time, old information is not overwritten with the new information. Before you re-create the database of the execution environment for submit jobs, always stop JP1/AJS3 and delete or back up the database that has been created. If you choose to delete the database, delete all files contained in the directory to be specified in the `-dp` option (the job execution environment database storage directory specified during environment setup).
In Windows, delete these files by a program such as **Explorer**.
In UNIX, delete these files with the `rm` command.
3. Use the character set for JP1/AJS3 operation as the character sets[#] used in the file specified by the `-ci` option.

It refers to the character set specified by the `AJSCHARCODE` environment setting parameter.
4. When you specify a database storage directory name in the `-dp` option, you must also make this specification during environment setup.
Specify a database storage directory name in the `DatabasePath` environment setting parameter.
5. If you execute this command when JP1/AJS3 is running on the same logical host, an error occurs.
6. Depending on the contents of the configuration definition file for the submit job execution environment, the collective definition processing for the job execution environment might take several tens of minutes.
7. When you re-create the job execution environment, you must delete the standard output file and standard error output file for the remaining job. If you re-create the job execution environment after executing a large number of jobs, it may take a longer time for command execution because of the processing for deleting these files.
8. Be careful if you decrease the maximum number of job execution agents, queues, or execution-locked resources that can be defined in the common definition information before you use this command to add or delete these items. If you do this, you might be unable to collectively import the job execution environment settings by using the `jppqimport` command from the configuration definition file for the submit job execution environment exported by the `jppqexport` command. For example, assume that there is an environment where the maximum number of agents that can be defined is set to 30 in the common definition information. In addition, assume that an agent ID whose ID is

100 has been specified in the configuration definition file for the submit job execution environment. In this situation, if you execute the `jpgimport` command to import the configuration definition file, the command results in an error.

If this error occurs, correct the configuration definition file for the submit job execution environment so that the defined ID numbers for agents, queues, and execution-locked resources do not exceed their maximum values set during environment setup. Then re-execute the `jpgimport` command.

9. The system handles lines beginning with a # as a comment. Place the # at the very beginning of a comment line. Placing # after a parameter causes an error.
10. If you omit the `-mh` option, the system does not reference environment variable `JP1_HOSTNAME`. To enable operation on the logical host, do not omit this option.

Return values

| | |
|-----|---|
| 0 | Normal end |
| 1 | The specified argument is invalid. |
| 130 | The configuration definition information file for submit job execution or its path is not found. |
| 132 | The contents of the configuration definition information file for submit job execution are inappropriate. |
| 133 | You do not have the privilege (are not authorized) to access the configuration definition information file for submit job execution. |
| 135 | The system cannot create a database because there are insufficient system resources. |
| 136 | The database is already created. |
| 137 | The database storage directory is missing. |
| 138 | You do not have the privilege (are not authorized) to access the database. |
| 140 | You do not have Administrators privileges (in Windows) or superuser privilege (in UNIX) to collectively define the job execution environment. |
| 141 | Environment settings or the logical host name is inappropriate. |
| 142 | The manager host is running on the same logical host. |
| 145 | There is insufficient memory. |
| 146 | Free disk space is insufficient. |
| 147 | An internal factor error occurred. |
| 149 | The system cannot perform processing because the database size exceeds 2 gigabytes. |
| 150 | The database cannot be connected. |
| 151 | RDAREA is invalid or RDAREA does not exist. |
| 153 | The command cannot be executed. |

Additional information

- When you want to change the configuration definition for the job execution environment by adding or deleting job execution agents, queues, or execution-locked resources, use any of the following methods:
 - Stop the JP1/AJS3 service and then recreate the database for job execution environment with this command. If you are executing a remote job, also stop the JP1/AJS3 service on the remote host.
 - Without stopping the job operation, change the configuration definition for job execution environment with any of the following commands:
 - `jpgagtadd`: Adds an agent.

jppagtdel: Deletes an agent.
 jppagtalt: Changes the attribute of an agent.
 jppagtlink: Links a queue and its agents and then changes the priority of the destination agents.
 jppagtunlink: Unlinks a queue and its agents.
 jppqqueueadd: Adds a queue.
 jppqquedel: Deletes a queue.
 jppqqueuealt: Changes the attributes of a queue.
 jppqqueueopen: Opens a queue.
 jppqqueueclose: Closes a queue.
 jppqresadd: Adds an execution-locked resource.
 jppqresdel: Deletes an execution-locked resource.

- You can use aliases to create several agents on a single manager host. Before you do this, make sure that the aliases can be resolved into addresses (the ping command is terminated normally).

Defining the configuration definition file for the submit job execution environment (jppqsetup.conf)

Define the following three items in the configuration definition file for submit job execution:

- Agent definition
- Queue definition
- Execution-locked resource definition

The following explains the definition of each item.

Agent definition

Format

```

$agent $agent-ID {agent-host-name|$system}
[exec_jobs time-to-start-setting-for-the-number-of-concurrent-jobs time-to
-stop-setting-for-the-number-of-concurrent-jobs number-of-concurrent-jobs]
...
def_queue $default-queue-ID
[max_jobs maximum-number-of-jobs-in-queue]
[warn_jobs warning-value-on-number-of-jobs-in-queue]
[queue_ent {open|close}]
[queue_exit {open|close}]
[connect $agent-ID priority]...
$end
  
```

Arguments

`$agent $agent-ID {agent-host-name|$system}`

Specify the name of the agent host responsible for job execution.

- `$agent`: Fixed
- `$agent-ID`: Specify an agent ID in the `$an` format (where `n` is a unique value in the manager host (a value other than 0)). For `n`, specify a value less than or equal to the number of defined agents specified at environment setting. (For example, if 256 agents are defined, specify a value that is less than or equal to 256 for `n`. Specifying a value that is greater than or equal to 257 will result in an error.)

- *agent-host-name*: Character string of up to 255 bytes
- *\$system*: Job execution agent on the manager host

exec_jobs time-to-start-setting-for-the-number-of-concurrent-jobs time-to-stop-setting-for-the-number-of-concurrent-jobs number-of-concurrent-jobs

Specify the number of concurrent jobs. If you omit this option, the system assumes 0 for the number of concurrent jobs for a day.

Specifying the number of concurrent jobs enables you to limit the number of jobs that can be concurrently executed by this agent host. You can apply this limit to standard jobs (UNIX, PC, and QUEUE jobs), action jobs, and custom jobs. If the number of jobs that you attempt to execute concurrently reaches the specified number of concurrent jobs, those jobs that exceed the limit will be queued until another job has finished.

If the number of concurrent jobs is 0, no jobs can be executed. If you want to execute jobs, specify 1 or a greater value.

- *time-to-start-setting-for-the-number-of-concurrent-jobs*: Specify the time to start setting for the number of concurrent jobs in the *hhmm* format. You can specify 00 to 23 (hours) for *hh* and 00 or 30 (minutes) for *mm*.
- *time-to-stop-setting-for-the-number-of-concurrent-jobs*: Specify the time to stop setting for the number of concurrent jobs in the *hhmm* format. You can specify 00 to 23 (hours) for *hh* and 00 or 30 (minutes) for *mm*.
- *number-of-concurrent-jobs*: Specify a value from 0 to 4,294,967,295.

def_queue \$default-queue-ID

Specify the default queue ID.

The default queue is required when you execute a job by specifying an agent host name. Specifying an agent host name as the job submission or execution destination causes the job to be submitted to the default queue of the agent host.

- *\$default-queue-ID*: Specify the default queue ID in the *\$qn* format (where *n* is a unique value (a value other than 0) for all the default queue and non-default queue IDs in the manager host). For *n*, specify a value less than or equal to the number of defined queues specified at environment setting. (For example, if 256 queues are defined, specify a value less than or equal to 256 for *n*. Specifying a value greater than or equal to 257 will result in an error.)

max_jobs maximum-number-of-jobs-in-queue

Specify the maximum number of jobs that can be accumulated in the default queue. If you omit this option, the system assumes 4,294,967,295. Note, however, that despite this setting, if the number of jobs remaining in the queue equals the value for maximum number of jobs in the system, job submission will fail.

This setting also includes the number of jobs that are actually being executed. The number of jobs is the sum of the values of *QUEUING* and *EXECUTING* displayed by the *jpqqshow* command with the *-q* option specified.

- *maximum-number-of-jobs-in-queue*: Specify a value from 1 to 4,294,967,295.

warn_jobs warning-value-on-number-of-jobs-in-queue

Specify a warning value indicating that the number of jobs in the default queue is nearing the maximum number of jobs that can be accumulated in the default queue. If you omit this option, the system assumes 4,294,967,295. This setting (including the default value) is for the number of jobs in the default queue, including the jobs that are being executed. When you specify the *-ah* option in the *jpqqshow* command to check, the number of jobs includes the jobs of both *QUEUING* and *EXECUTING*.

When the number of jobs reaches the warning value, the warning message KAVU4516-W is output to the integrated trace log.

- *warning-value-on-number-of-jobs-in-queue*: This value must be no more than the maximum number of jobs that can be queued and must be in the range from 1 to 4,294,967,295.

`queue_ent {open|close}`

Specify the status of the queue entrance of the default queue for jobs. If the entrance is closed, no jobs can be put into the default queue. If you omit this option, the system assumes `open`.

- `open`: Opens the queue entrance.
- `close`: Closes the queue entrance.

`queue_exit {open|close}`

Specify the status of the exit of the default queue for jobs. If the exit is closed, jobs are accumulated in the queue and are not executed. If you omit this option, the system assumes `open`.

- `open`: Opens the queue exit.
- `close`: Closes the queue exit.

`connect $agent-ID priority`

Specify the ID of the agent host to be connected to the default queue. You can specify several agent host IDs. If you omit this option, you cannot execute jobs in which agent host names are specified.

- `$agent-ID`: Specifies the ID of the agent host to be connected in the `$an` format.
- `priority`: Specifies a value from 1 to 16 (the lowest priority is 1 and the highest priority is 16). Jobs are executed in descending order of priority.

`$end`

Specifies the end of the agent information.

- `$end`: Fixed

Example of coding:

```
$agent $a1 $system
exec_jobs 0000 0730 10
exec_jobs 0730 2000 1
exec_jobs 2000 0000 5
def_queue $q1
max_jobs 10
warn_jobs 5
queue_ent open
queue_exit open
connect $a1 1
$end

$agent $a2 agent1
exec_jobs 0000 0000 10
def_queue $q2
max_jobs 10
warn_jobs 5
queue_ent open
queue_exit open
connect $a1 1
connect $a2 2
$end
```

Queue definition

Format

```
$queue $queue-ID queue-name
[max_jobs maximum-number-of-jobs-in-queue]
```

```
[warn_jobs warning-value-on-number-of-jobs-in-queue]
[queue_ent {open|close}]
[queue_exit {open|close}]
[connect $agent-ID priority]...
$end
```

Arguments

`$queue $queue-ID queue-name`

Specify a queue name. Note that agent names are not case sensitive, but that queue names are.

- `$queue`: Fixed
- `$queue-ID`: Specify the queue ID in the `$qn` format (where *n* is a unique value (a value other than 0) for all default queue IDs and non-default queue IDs in the manager host). For *n*, specify a value that is less than or equal to the number of defined queues specified at environment setting. (For example, if 256 queues are defined, specify a value less than or equal to 256 for *n*. Specifying a value greater than or equal to 257 will result in an error.)
- `queue-name`: Character string of up to 63 bytes

`max_jobs maximum-number-of-jobs-in-queue`

Specify the maximum number of jobs that can be accumulated in the queue. If you omit this option, the system assumes 4,294,967,295. Note, however, that, despite this setting, if the number of jobs remaining in the queue equals the value for maximum number of jobs in the system, job submission will fail.

This setting also includes the number of jobs that are actually being executed. The number of jobs is the sum of the values of `QUEUING` and `EXECUTING` displayed by the `jpqqshow` command with the `-q` option specified.

- `maximum-number-of-jobs-in-queue`: Specify a value from 1 to 4,294,967,295.

`warn_jobs warning-value-on-number-of-jobs-in-queue`

Specify a warning value indicating that the number of jobs in the queue nears the maximum number of jobs that can be accumulated in the queue. If you omit this option, the system assumes 4,294,967,295.

This setting also includes the number of jobs that are actually being executed. The number of jobs is the sum of the values of `QUEUING` and `EXECUTING` displayed by the `jpqqshow` command with the `-q` option specified.

When the number of jobs reaches the warning value, the warning message KAVU4516-W is output to the integrated trace log.

- `warning-value-on-number-of-jobs-in-queue`: This value must be no more than the maximum number of jobs that can be queued and must be in the range from 1 to 4,294,967,295.

`queue_ent {open|close}`

Specify the status of the queue entrance for jobs. If the entrance is closed, no jobs can be put into the default queue. If you omit this option, the system assumes `open`.

- `open`: Opens the queue entrance.
- `close`: Closes the queue entrance.

`queue_exit {open|close}`

Specify the status of the queue exit for jobs. If the exit is closed, jobs are accumulated in the queue and are not executed. If you omit this option, the system assumes `open`.

- `open`: Opens the queue exit.
- `close`: Closes the queue exit.

`connect $agent-ID priority`

Specify the ID of the agent host to be connected to the queue. You can specify several agent host IDs. If you omit this option, you cannot execute those jobs that specify queue names.

- *\$agent-ID*: Specifies the ID of the agent host to be connected in the *\$an* format.
- *priority*: Specifies a value from 1 to 16 (the lowest priority is 1 and the highest priority is 16). Jobs are executed in descending order of priorities.

\$end

Specifies the end of queue information.

- *\$end*: Fixed

Example of coding:

```
$queue $q3 queue1
max_jobs 10
warn_jobs 5
queue_ent open
queue_exit close
connect $a1 1
connect $a2 2
$end
```

Execution-locked resource definition

Format

```
$res $execution-locked-resource-ID execution-locked-resource-name
$end
```

Arguments

\$res \$execution-locked-resource-ID execution-locked-resource-name

Specify an execution-locked resource name.

- *\$res*: Fixed
- *\$execution-locked-resource-ID*: Specify the execution-locked resource ID in the *\$rn* format (where *n* is a unique value in the manager host (value other than 0)). For *n*, specify a value less than or equal to the number of defined execution-locked resources specified at environment setting. (For example, if 256 execution-locked resources are defined, specify a value less than or equal to 256 for *n*. Specifying a value greater than or equal to 256 will result in an error.)
- *execution-locked-resource-name*: Character string of up to 63 bytes

\$end

Specifies the end of execution-locked resource information.

- *\$end*: Fixed

Example of coding:

```
$res $r1 DAT_System
$end

$res $r2 Temp_File01
$end
```

jpqjobalt

Format

```
jpqjobalt
  [-mh manager-host-name]
  {-q queue-name|-ah agent-host-name}
  {-h|-hr}
  -j job-number
```

Description

Holds a job or releases a held job.

This command is applicable for the following jobs:

When the database is in a standard configuration:

Submit jobs and queue jobs

When the database is in a standard configuration without ISAM:

None

Execution privileges

You must have any of the following JP1 privileges:

- JP1_JPQ_Admin privilege
- JP1_JPQ_Operator privilege
- JP1_JPQ_User privilege (allows you to manipulate only the jobs you own)

Arguments

-mh *manager-host-name*

Specify the host name of the manager to which you have submitted a job to be held or released.

You can specify a character string of 1 to 255 bytes.

By default, the system assumes the local host name.

-q *queue-name*

Specify the name of the queue to which you have submitted a job to be held or released.

You can specify a character string of 1 to 63 bytes.

-ah *agent-host-name*

Specify the name of the agent host to which you have submitted a job to be held or released.

You can specify a character string of 1 to 255 bytes.

-h

Holds a job.

-hr

Releases a held job.

-j *job-number*

Specify the job number of a job to be held or released.

You can use the `jpqjjobshow` command to check the job number.

Make sure that you specify a job number in the range from 1 to 999999.

Note

This command cannot be used for a request from JP1/AJS3 to JP1/OJE for VOS3.

Return values

| | |
|-----|--|
| 0 | Normal end |
| 1 | Invalid parameter value |
| 2 | The job could not be held or released successfully owing to an internal cause of the hold or release requester. |
| 5 | Initialization has failed. <ul style="list-style-type: none">The definition of the logical host name or the environment setting contains an error. |
| 6 | Hold or release requester's insufficient memory |
| 7 | The hold or release requester encountered a logic error. |
| 100 | The manager host cannot be connected for TCP/IP communication. <ul style="list-style-type: none">Because TCP/IP is not validly set, the manager host cannot be connected.The manager host name is invalid, or the manager host process stopped. |
| 102 | The IP address could not be solved successfully by the manager host name. |
| 200 | The manager host does not accept a job hold or release request. <ul style="list-style-type: none">The manager host is now being started, now being stopped, has stopped, or is running in the reduced-operation mode. |
| 201 | You cannot use a specified queue. <ul style="list-style-type: none">The specified queue is not found. |
| 202 | No response from the manager host |
| 203 | The job could not be held or released successfully owing to an internal cause of the manager host. |
| 206 | You do not have the privilege required to hold or release the job. |
| 207 | The job to be held or released does not exist. <ul style="list-style-type: none">The specified job is not in the database.The specified job has already ended. |
| 208 | The specified job is running. |
| 219 | The manager host is busy. |
| 220 | Insufficient manager host memory |
| 222 | A fatal error has occurred. <ul style="list-style-type: none">An error has occurred in a system call. |
| 223 | The manager host encountered a logic error. |
| 224 | You have issued a job hold or hold release request to an unsupported host. |

Additional information

Even if you set the `-h` option for a held job or the `-hr` option for a job waiting for execution or time, the command ends normally. The job status is not, however, changed.

jpqjobcan

Format

```
jpqjobcan
  [-mh manager-host-name]
  {-q queue-name|-ah agent-host-name}
  -j job-number
  [-em]
```

Description

Cancels execution of a job waiting for execution, being held, or waiting for time.

A job being executed is killed.

UNIX-based jobs can be forcibly terminated even with a signal-seizing application because SIGKILL is issued.

You can also cancel or kill the JP1/OJE for VOS3. In that case, however, the user can operate only the jobs he or she owns.

You can also cancel or kill jobs for the AS/400 system. You can specify only the `-mh`, `-q`, and `-j` options for the AS/400 system.

This command is applicable for the following jobs:

When the database is in a standard configuration:

Submit jobs and queue jobs

To forcibly terminate a PC job, Unix job, action job, or custom job, use the `ajskill` command.

When the database is in a standard configuration without ISAM:

None

Execution privileges

You must have any of the following JP1 privileges:

- JP1_JPQ_Admin privilege
- JP1_JPQ_Operator privilege
- JP1_JPQ_User privilege (allows you to manipulate only the jobs you own)

However, specifying the `-em` option requires the following privileges (but does not require JP1_JPQ_Admin, JP1_JPQ_Operator, or JP1_JPQ_User privileges).

- Windows: Administrators privileges
- UNIX: Superuser privileges

Arguments

`-mh` *manager-host-name*

Specify the name of the manager host to which you have submitted a job to be canceled or killed.

You can specify a character string of 1 to 255 bytes.

By default, the system assumes the local host name.

When you specify this option together with the `-em` option, you can specify only two types of host names: the local host name and the logical host name on the local host. Specifying any other value results in an error (error code: 25). Also note that you cannot specify an alias host name in the `-mh` option.

-q *queue-name*

Specify the name of the queue to which you have submitted a job to be canceled or killed.

You can specify a character string of 1 to 63 bytes.

-ah *agent-host-name*

Specify the name of the agent host to which you have submitted a job to be canceled or killed.

You can specify a character string of 1 to 255 bytes.

This option cannot be specified for a request from JP1/AJS3 to JP1/OJE for VOS3.

-j *job-number*

Specify the job number of a job to be canceled or killed.

You can use the `jspqjobshow` command to check the job number.

Make sure that you specify a job number in the range from 1 to 999999.

-em

Specify this option for emergency execution.

Specifying this option enables emergency execution upon failure because a request is sent to a different communication path that is not used under normal conditions.

When you specify this option, note that you cannot assign an IP address to the manager host name.

Note

You should use the `-em` option for the sole purpose of recovering from an agent failure. You should avoid specifying the `-em` option under any normal condition, because you may fail to take corrective action when a failure actually occurs.

Return values

| | |
|-----|---|
| 0 | Normal end |
| 1 | Invalid parameter value |
| 2 | The job could not be canceled or killed successfully owing to an internal cause of the cancel or kill requester. |
| 5 | Initialization has failed. <ul style="list-style-type: none">The definition of the logical host name or the environment setting contains an error. |
| 6 | Cancel or kill requester's insufficient memory |
| 7 | The cancel or kill requester encountered a logic error. |
| 25 | The specified manager host name is neither the local host name nor the logical host name. |
| 100 | The manager host cannot be connected for TCP/IP communication. <ul style="list-style-type: none">Because TCP/IP is not validly set, the manager host cannot be connected. |

| | |
|-----|---|
| 100 | <ul style="list-style-type: none"> The manager host name is invalid, or the manager host process stopped. |
| 102 | The IP address could not be solved successfully by the manager host name. |
| 200 | <p>The manager host does not accept a job cancel or kill request.</p> <ul style="list-style-type: none"> The manager host is now being started, now being stopped, has stopped, or is running in the reduced-operation mode. |
| 201 | <p>You cannot use a specified queue.</p> <ul style="list-style-type: none"> The specified queue is not found. |
| 202 | No response from the manager host |
| 203 | The job could not be canceled or killed successfully owing to an internal cause of the manager host. |
| 206 | You do not have the privilege required to cancel or kill the job. |
| 207 | <p>The job to be canceled or killed does not exist.</p> <ul style="list-style-type: none"> The specified job is not in the database. The specified job has already ended. |
| 219 | The manager host is busy. |
| 220 | Insufficient manager host memory |
| 221 | Invalid user information about JP1/OJE for VOS3 |
| 222 | <p>A fatal error has occurred.</p> <ul style="list-style-type: none"> A system call error has occurred. |
| 223 | The manager host encountered a logic error. |
| 224 | You have issued a job cancel or kill request to an unsupported host. |
| 226 | Invalid execution environment |
| 230 | You have attempted to kill a job, but the agent host has failed to kill the job. It cannot be determined whether the job has ended. (The <code>jpqjobget</code> command runs to check the job status, however, indicates that the job has ended.) |

jpqjobdel

Format

```
jpqjobdel  
  [-mh manager-host-name]  
  -j job-number
```

Description

Deletes ended job information from the database.

This command is applicable for the following jobs:

When the database is in a standard configuration:

Submit jobs and queue jobs

When the database is in a standard configuration without ISAM:

None

Execution privileges

You must have either of the following JP1 privileges:

- JP1_JPQ_Admin privilege
- JP1_JPQ_Operator privilege

Arguments

-mh *manager-host-name*

Specify the name of the manager host to which you have submitted a job whose ended job information is to be deleted.

You can specify a character string of 1 to 255 bytes.

By default, the system assumes the local host name.

-j *job-number*

Specify the job number of a job whose ended job information is to be deleted.

You can use the `jpqendjobshow` command to check the job number.

Make sure that you specify a job number in the range from 1 to 999999.

Note

This command cannot be used for a request from JP1/AJS3 to JP1/OJE for VOS3.

Return values

| | |
|---|---|
| 0 | Normal end |
| 1 | Invalid parameter value |
| 2 | Ended job information could not be deleted successfully owing to an internal cause of the ended job information delete requester. |

| | |
|-----|--|
| 5 | Initialization has failed. <ul style="list-style-type: none"> The definition of the logical host name or the environment setting contains an error. |
| 6 | Ended job information delete requester's insufficient memory |
| 7 | The ended job information delete requester encountered a logic error. |
| 100 | The manager host cannot be connected for TCP/IP communication. <ul style="list-style-type: none"> Because TCP/IP is not validly set, the manager host cannot be connected. The manager host name is invalid, or the manager host process stopped. |
| 102 | The IP address could not be solved successfully by the manager host name. |
| 200 | The manager host does not accept an ended job information delete request. <ul style="list-style-type: none"> The manager host is now being started, now being stopped, has stopped, or is running in the reduced-operation mode. |
| 202 | No response from the manager host |
| 203 | Ended job information could not be deleted successfully owing to an internal cause of the manager host. |
| 206 | You do not have the privilege required to delete ended job information. |
| 207 | The job information to be deleted does not exist. <ul style="list-style-type: none"> The specified ended job information is not in the database. |
| 208 | The specified job has not yet ended. |
| 219 | The manager host is busy. |
| 220 | Insufficient manager host memory |
| 222 | A fatal error has occurred. <ul style="list-style-type: none"> A system call error has occurred. |
| 223 | The manager host encountered a logic error. |
| 224 | You have issued a request to a host other than JP1/AJS3. |
| 226 | Invalid execution environment |

jpqjobget

Format

```
jpqjobget
  [-mh manager-host-name]
  [{-q queue-name|-ah agent-host-name}]
  -j job-number
  [-oso standard-output-file-name]
  [-ose standard-error-output-file-name]
  [-di]
  [-cc]
  [-ea]
```

Description

Outputs job information about a certain job to the standard output file.

You can also output job information about the JP1/OJE for VOS3 hosts. In that case, however, the user can operate only the jobs he or she owns.

This command also outputs job information about the AS/400 system to the standard output file. You can specify only the `-mh`, `-q`, and `-j` options for the AS/400 system.

This command is applicable for the following jobs:

When the database is in a standard configuration:

Submit jobs and queue jobs

When the database is in a standard configuration without ISAM:

None

Execution privileges

You must have any of the following JP1 privileges:

- JP1_JPQ_Admin privilege
- JP1_JPQ_Operator privilege
- JP1_JPQ_User privilege (allows you to manipulate only the jobs you own)

Arguments

`-mh` ***manager-host-name***

Specify the name of the manager host to which you have submitted a job whose job information is to be output.

You can specify a character string of 1 to 255 bytes.

By default, the system assumes the local host name.

`-q` ***queue-name***

Specify the name of the queue to which you have submitted a job whose job information is to be output.

You can specify a character string of 1 to 63 bytes.

-ah agent-host-name

Specify the name of the agent host to which you have submitted a job whose job information is to be output.

You can specify a character string of 1 to 255 bytes.

This option cannot be specified for a request from JP1/AJS3 to JP1/OJE for VOS3.

-j job-number

Specify the job number of a job from which you want to output job information.

Make sure that you specify a job number in the range from 1 to 999999.

-oso standard-output-file-name

Specify the name of the file used to acquire the data in the standard output file which is output when the job set by the `-j` option is executed.

You can specify a character string of 1 to 511 bytes.

-ose standard-error-output-file-name

Specify the name of the file used to acquire the data in the standard error output file which is output when the job set by the `-j` option is executed.

You can specify a character string of 1 to 511 bytes.

-di

Outputs detailed information about the job specified with the `-j` option.

-cc

Outputs the character set used by the agent that has executed the job specified with the `-j` option.

-ea

Outputs the name of the agent host where the job specified with the `-j` option is executed.

Notes

- As a result of job execution, if the standard output file and standard error output file are moved or deleted, you cannot obtain information about these files.
- If a file of several megabytes is transferred either during job registration or as the result of job information collection, the transfer may fail or take time.

Return values

| | |
|---|--|
| 0 | Normal end |
| 1 | Invalid parameter value |
| 2 | Job information could not be output successfully owing to an internal cause of the output requester. |
| 5 | Initialization has failed. <ul style="list-style-type: none"> • The definition of the logical host name or the environment setting contains an error. |
| 6 | Job information output requester's insufficient memory |

| | |
|-----|---|
| 7 | The job information output requester encountered a logic error. |
| 13 | The file used to acquire data in the standard or standard error output file cannot be created because no file path exists. |
| 14 | The file used to acquire data in the standard output file or standard error output file cannot be created because you do not have the privilege required to access it. |
| 15 | The data in the standard output file or standard error output file cannot be written to the file owing to the insufficient disk size. |
| 16 | The file used to acquire data in the standard output file or standard error output file cannot be opened because it is used by another process. |
| 17 | The file used to acquire data in the standard output file or standard error output file cannot be created owing to a cause other than return values 13, 14, 15 and 16. |
| 18 | The standard output file or standard error output file could not be written successfully owing to a cause other than return values 13, 14, 15 and 16. |
| 19 | The file cannot be created because data in the standard output file or standard error output file could not be acquired from the manager host. |
| 100 | The manager host cannot be connected for TCP/IP communication. <ul style="list-style-type: none"> • Because TCP/IP is not validly set, the manager host cannot be connected. • The manager host name is invalid, or the manager host process stopped. |
| 102 | The IP address could not be solved successfully by the manager host name. |
| 200 | The manager host does not accept output job information. <ul style="list-style-type: none"> • The manager host is now being started, now being stopped, has stopped, or is running in the reduced-operation mode. |
| 201 | You cannot use a specified queue. <ul style="list-style-type: none"> • The specified queue is not found. |
| 202 | No response from the manager host |
| 203 | Job information could not be output successfully owing to an internal cause of the manager host. |
| 206 | You do not have the privilege required to output job information. |
| 207 | The specified job is not found. <ul style="list-style-type: none"> • The specified job is not in the database. • The specified job information is deleted. |
| 219 | The manager host is busy. |
| 220 | Insufficient manager host memory |
| 222 | A fatal error has occurred. <ul style="list-style-type: none"> • A system call error has occurred. |
| 223 | The manager host encountered a logic error. |
| 224 | An unsupported host was told to output job information. |
| 226 | Invalid execution environment |

Output example

The following gives an example of file output.

```
JOBID : 10
OWNER : user1
JOBNAME : joblongname
QUEUE : queue1
STATUS : END
EXITCODE : 0
ENTRYTIME : 20XX/06/01.00:00:00
STARTTIME : 20XX/06/01.00:00:01
ENDTIME : 20XX/06/01.00:10:00
DETAILEDSTATUS : NORMAL END
CHARCODE : ASCII
AGENTNAME : agentname1
```

The following gives the meanings of output contents.

JOBID

Indicates a job number.

OWNER

Indicates the job's owner name.

JOBNAME

Indicates a job name.

When you use a QUEUE job or the `jpqj obsub` command to specify a job name, that job name is set. If no job name is specified, the execution file name is set.

When you define a PC job in a jobnet, the execution file name is set. When you define a Unix job in a jobnet, the script file name is set. If you do not specify a script file name, and then define a job name in a command statement, `script_job` is set as the job name.

For an action job, the name of the fixed execution file executed by each action job is set as the job name. For an execution file name, the first 63 bytes of the characters from the beginning in the file name, excluding the path information, are set as the job name.

QUEUE

Indicates a queue name (or an agent host name).

STATUS

Shows the job status.

- ROUTING: Being distributed
- SCHEDULED: Waiting for a time
- WAITING: Waiting to be executed
- EXECUTING: Being executed
- HOLDING: Placed on hold
- END: End

EXITCODE

Indicates a job return code. or details about the job return code, see *7.11.3 Checking the return code of a job in the JP1/Automatic Job Management System 3 System Design (Work Tasks) Guide*.

ENTRYTIME

Indicates the time of job submittal in the format of *YYYY/MM/DD .hh:mm:ss*.

STARTTIME

Indicates the job execution start time in the format of *YYYY/MM/DD .hh:mm:ss*.

ENDTIME

Indicates the job execution end time in the format of *YYYY/MM/DD .hh:mm:ss*.

DETAILEDSTATUS

Indicates detailed information about the job. This item is output only when you specify the `-di` option

- `END IN ANOTHER SYSTEM`: Ended by another system (detail information not acquired)
- `WAITING`: Waiting to be executed
- `HOLDING`: Placed on hold
- `SCHEDULED`: Waiting for a time
- `ROUTING`: Being routed
- `EXECUTING`: Being executed
- `NORMAL END`: Ended normally^{#1}
- `WARNING END`: Ended with warning^{#1}
- `ABNORMAL END`: Ended abnormally^{#1}
- `EXECUTION TIMED OUT`: Ended with the abortion of execution
- `CANCELED END`: Canceled (cancel request given before start of execution)
- `FORCIBLY TERMINATED`: Killed (cancel request given after start of execution)
- `FAILURE WHILE STARTING EXECUTION`: Failure during starting execution
- `FAILURE WHILE ENDING EXECUTION`: Failure during ending execution^{#2}

#1

If you set an end judgment in a job created in a jobnet, the end status is based on the judgment method.

For the `jpqj obsub` command, you cannot set an end judgment in a job. Therefore, the warning threshold value and the abnormal threshold value are 0. The detailed job information indicates a normal end when the job ends with a return code of 0. However, if the job ends with a value other than 0, then an abnormal end occurred.

#2

This status might occur if an error occurs during the end processing after the execution of a job process or the exchange of end information between the agent host and the manager host, after the job has ended. For details about the error, check the applicable message `KAVUxxxx` output in the integrated trace log.

For the job executed by the agent host, the process itself is ended. To check the end status of the process, check the execution history of job processes or other resources.

CHARCODE

Indicates the character set used by the agent that has executed the job. This item is output only when you specify the `-cc` option

- `ASCII`: ASCII
- `SJIS`: Shift JIS
- `JP_EUC`: EUC

- UTF-8: UTF-8

If the job execution is not ended or if the job is executed by another system:

- UNKNOWN: Unknown character set

AGENTNAME

Indicates the name of the agent host where the job is executed. This item is output only when you specify the `-ea` option

If the agent host name cannot be obtained, "AGENTNAME : " is displayed.

Note that the *YYYY/MM/DD.hh:mm:ss* part means *calendar-year/month/day.hours:minutes:seconds*.

jpqjobmove

Format

```
jpqjobmove
  [-mh manager-host-name]
  {-q queue-name|-ah agent-host-name}
  {-dq destination-queue-name|-p+|-p-} execution-order}
  -j job-number
```

Description

Moves a job in a queue.

The movement encounters the restrictions below.

- You can move only the jobs other than those running or ended.
- You can specify as the job destination only the queue in the same manager host as the movement sources.
- For jobs in the default queue.
 - You cannot move jobs between queues.
 - You can specify an arbitrary job execution order within the default queue.
- For jobs in queues other than the default queue:
 - You cannot specify the default queue as the movement destination.
 - If you specify the name of the movement destination queue which is the same as the movement source queue, the job is executed last.
 - If you specify the name of the movement destination queue which is the same as the movement source queue, you can specify an arbitrary job execution order.
 - If the movement source queue is different from the destination queue, the job is executed last.
- For QUEUE jobs registered from a jobnet
 - You cannot move jobs between queues.

This command is applicable for the following jobs:

When the database is in a standard configuration:

Submit jobs and queue jobs

When the database is in a standard configuration without ISAM:

None

Execution privileges

You must have any of the following JP1 privileges:

- JP1_JPQ_Admin privilege
- JP1_JPQ_Operator privilege
- JP1_JPQ_User privilege (allows you to move jobs between queues only)

Arguments

-mh *manager-host-name*

Specify the name of the manager host to which you have submitted a job to be moved.

You can specify a character string of 1 to 255 bytes.

By default, the system assumes the local host name.

-q *queue-name*

Specify the name of the queue to which you have submitted a job to be moved. To change the job execution order in a queue other than the default queue, or to move a job between queues, specify this option.

You can specify a character string of 1 to 63 bytes.

-ah *agent-host-name*

Specify the name of the agent host to which you have submitted a job to be moved. To change the order in which jobs in the default queue are executed, specify this option.

You can specify a character string of 1 to 255 bytes.

You cannot specify this option with the **-dq** option.

-dq *destination-queue-name*

Specify the name of the queue where you want to move a job.

You can specify a character string of 1 to 63 bytes.

You cannot specify this option with the **-ah** option.

You cannot specify this option with the **-p+** or **-p-** option.

{ -p+ | -p- } *execution-order*

Specify the order in which the jobs in the queue are executed.

- **-p+**
Moves the job so that it will be executed earlier.
- **-p-**
Moves the job so that it will be executed later.
- *execution-order*
Specify the order in which jobs are executed in relative order from the current order. (For example, to change current execution order 5 to 3, set **-p+ 2**.)

If the number of jobs in the queue is less than the specified execution order, it is moved to the top of the queue when you set **-p+**, and to the end when you set **-p-**. (For example, if the queue contained fewer than five jobs although you set **-p+ 5**, the system performs processing as if you set execution order 1.)

You cannot specify this option with the **-dq** option.

-j *job-number*

Specify the job number of a job to be moved.

You can use the `jpqjobshow` command to check the job number.

Make sure that you specify a job number in the range from 1 to 999999.

Note

This command cannot be used for a request from JP1/AJS3 to JP1/OJE for VOS3.

Return values

| | |
|-----|--|
| 0 | Normal end |
| 1 | Invalid parameter value |
| 2 | The job could not be moved successfully owing to an internal cause of the job movement requester. |
| 5 | Initialization has failed. <ul style="list-style-type: none">• The definition of the logical host name or the environment setting contains an error. |
| 6 | Job movement requester's insufficient memory |
| 7 | The job movement requester encountered a logic error. |
| 100 | The manager host cannot be connected for TCP/IP communication. <ul style="list-style-type: none">• Because TCP/IP is not validly set, the manager host cannot be connected.• The manager host name is invalid, or the manager host process stopped. |
| 102 | The IP address could not be solved successfully by the manager host name. |
| 200 | The manager host does not accept a job movement request. <ul style="list-style-type: none">• The manager host is now being started, now being stopped, has stopped, or is running in the reduced-operation mode. |
| 201 | You cannot use a specified queue. <ul style="list-style-type: none">• The specified queue is not found. |
| 202 | No response from the manager host |
| 203 | The job could not be moved successfully owing to an internal cause of the manager host. |
| 206 | You do not have the privilege required to move the job. |
| 207 | The job to be moved does not exist. <ul style="list-style-type: none">• The specified job is not in the database.• The specified job has ended. |
| 208 | The specified job is running. |
| 209 | The queue set as the destination is not found. |
| 210 | Because the number of submit jobs has reached the limit value in the queue set as the destination, you cannot move the job. |
| 219 | The manager host is busy. |
| 220 | Insufficient manager host memory |
| 222 | A fatal error has occurred. <ul style="list-style-type: none">• A system call error has occurred. |
| 223 | The manager host encountered a logic error. |
| 224 | You have issued a request to a host other than JP1/AJS3. |

| | |
|-----|-------------------------------|
| 226 | Invalid execution environment |
|-----|-------------------------------|

jpqjobshow

Format

```
jpqjobshow
  [-mh manager-host-name]
  {-q queue-name|-ah agent-host-name}
  [-u owner-name]
  -s {e|h|w|s|r}
```

Description

Outputs a list of information on the jobs not ended (including job numbers, job names and job status) to the standard output file.

You can also output job information about the JP1/OJE for VOS3 hosts.

You can also output job information about the AS/400 system. You can, however, specify only the `-mh`, `-q`, `-u`, and `-s` options for the AS/400 system.

This command is applicable for the following jobs:

When the database is in a standard configuration:

Submit jobs and queue jobs

When the database is in a standard configuration without ISAM:

None

Execution privileges

You must have any of the following JP1 privileges:

- JP1_JPQ_Admin privilege
- JP1_JPQ_Operator privilege
- JP1_JPQ_User privilege (allows you to manipulate only the jobs you own)

Arguments

-mh *manager-host-name*

Specify the name of the manager host to which you have submitted a job whose job information is to be output.

You can specify a character string of 1 to 255 bytes.

By default, the system assumes the local host name.

-q *queue-name*

Specify the name of the queue to which you have submitted a job whose job information is to be output.

You can specify a character string of 1 to 63 bytes.

-ah *agent-host-name*

Specify the name of the agent host to which you have submitted a job whose job information is to be output.

You can specify a character string of 1 to 255 bytes.

This option cannot be specified for a request from JP1/AJS3 to JP1/OJE for VOS3.

-u *owner-name*

To output information about a job the user has submitted, specify the job owner name.

You can specify a character string of 1 to 63 bytes. By default, the system assumes all the users if a user having the JP1_JPQ_Admin privilege or JP1_JPQ_Operator privilege executes the command. If a user having the JP1_JPQ_User privilege executes the command, the system assumes that user.

-s {*e|h|w|s|r*}

Outputs information about a job in certain status. You can specify multiple types of status.

- e
Outputs information about an executing job.
- h
Outputs information about a held job.
- w
Outputs information about a job waiting to be executed.
- s
Outputs information about a job waiting for time.
- r
Outputs information about a job being distributed.

Note

The number of bytes which can be output is fixed for each output item. If the contents of an output item exceed the output limit, they end with ". .". (For example, the job name output limit is 26 bytes. If the job name exceeds 26 bytes, the 25th and subsequent bytes become ". .".)

To output all the contents on each output item, use the `jpgjobget` command.

Return values

| | |
|-----|---|
| 0 | Normal end |
| 1 | Invalid parameter value |
| 2 | Information about a job not ended could not be output successfully owing to an internal cause of the output requester. |
| 5 | Initialization has failed. <ul style="list-style-type: none">• The definition of the logical host name or the environment setting contains an error. |
| 6 | Insufficient memory in the output requester of information about a job not ended |
| 7 | The output requester of information about a job not ended encountered a logic error. |
| 100 | The manager host cannot be connected for TCP/IP communication. <ul style="list-style-type: none">• As TCP/IP is not validly set, the manager host cannot be connected.• The manager host name is invalid, or the manager host process stopped. |
| 102 | The IP address could not be solved successfully by the manager host name. |

| | |
|-----|---|
| 200 | The manager host does not accept a request for outputting information about a job not ended. <ul style="list-style-type: none"> The manager host is now being started, now being stopped, has stopped, or is running in the reduced-operation mode. |
| 201 | You cannot use a specified queue. <ul style="list-style-type: none"> The specified queue is not found. |
| 202 | No response from the manager host |
| 203 | Information about a job not ended could not be output successfully owing to an internal cause of the manager host. |
| 206 | You do not have the privilege required to output information about a job not ended. |
| 207 | The specified job is not found. <ul style="list-style-type: none"> The specified job is not in the database. As the specified user job not ended cannot be accessed, its information cannot be output. |
| 219 | The manager host is busy. |
| 220 | Insufficient manager host memory |
| 222 | A fatal error has occurred. <ul style="list-style-type: none"> A system call error has occurred. |
| 223 | The manager host encountered a logic error. |
| 224 | You have issued a non-ended job information output request to an unsupported host. |
| 226 | Invalid execution environment |

Output example

The following gives an example of file output.

| JOBID | JOBNAME | T | QUEUE | STATUS |
|-------|----------------------------|---|--------|-----------|
| 1 | jobname1onglonglonglmgm... | q | queue1 | EXECUTING |
| 2 | job2 | q | queue1 | WAITING |
| 4 | job4 | q | queue1 | SCHEDULED |
| 5 | job5 | q | queue1 | HOLDING |

The following gives the meanings of output contents.

JOBID

Indicates a job number.

JOBNAME

Indicates a job name.

26 bytes of data are output.

When you use a QUEUE job or the jpqj obsub command to specify a job name, that job name is set. If no job name is specified, the execution file name is set.

When you define a PC job in a jobnet, the execution file name is set. When you define a Unix job in a jobnet, the script file name is set. If you do not specify a script file name, and define a job name in a command statement, `script_job` is set as the job name.

For an action job, the name of the fixed execution file executed by each action job is set as the job name. For an execution file name, the first 63 bytes of the characters from the beginning in the file name, excluding the path information, are set as the job name, and the first 26 bytes are displayed.

T

Indicates a queue type.

- q: Queue
- a: Agent host

QUEUE

Indicates a queue name (or an agent host name).

27 bytes of data are output.

STATUS

Shows the job status.

- EXECUTING: Being executed
- HOLDING: Placed on hold
- WAITING: Waiting to be executed
- SCHEDULED: Waiting for a time
- ROUTING: Being distributed

jpqjobsub

Format

```
jpqjobsub
  [-mh manager-host-name]
  {-q queue-name|-ah agent-host-name}
  [-eu user-name]
  [-jn job-name]
  [-pr execution-priority]
  -sc target-file-name
  [-arg "arguments..."]
  [-w work-path-name]
  [-shl shell-path-name]
  [-res execution-locked-resource-name]
  [-st execution-start-time]
  [-el time-out-period]
  [-si standard-input-file-name]
  [-rs {q|h|d}]
  [-so|-son standard-output-file-name|-soa standard-output-file-name]
  [-se|-sen standard-error-output-file-name|-sea standard-error-output-f
ile-name]
  [-ev environment-variable-file-name]
  [[-env environment-variable-name=value]...]
  [-h]
  [-t transfer-source-file-name[=transfer-destination-file-name]]...
  [-td transfer-source-file-name[=transfer-destination-file-name]]...
```

Description

The `jpqjobsub` command registers a submit job. This command can be used to register a PC job, a Unix job, a queue job (a job to be registered in a queue), or a queueless job. This command can also be used to register a submit job with a JP1/OJE for VOS3 host, or a AS/400 system. Note that a job to be registered in another system is a queue job, so a queue must be created in the other system before the job is registered.

| Destination of registration | Specifiable options |
|-----------------------------|----------------------------|
| JP1/OJE for VOS3 host | -mh,-q,-jn,-sc,-arg,-t |
| AS/400 system | -mh,-q,-jn,-pr,-sc,-arg,-t |

The other options are ignored even if they are specified.

Execution privileges

You must have any of the following JP1 privileges:

- JP1_JPQ_Admin privilege
- JP1_JPQ_Operator privilege
- JP1_JPQ_User privilege (allows you to manipulate only the jobs you own)

Arguments

-mh *manager-host-name*

Specify the name of the manager host to which you want to register a submit job.

You can specify a character string of 1 to 255 bytes.

By default, the system assumes the local host name.

-q *queue-name*

If you want to execute a queue job, which is queued and then executed, specify the name of the queue.

You can specify a character string of 1 to 63 bytes. If you want to register a job in another system, specify this option instead of the `-ah` option.

-ah *agent-host-name*

If you want to execute a PC or Unix job for which the host where the job will be executed is specified, specify the agent host name.

You can specify a character string of 1 to 255 bytes. You cannot specify this option when you register a job in another system.

-eu *user-name*

Specify the OS user name. Make sure that the OS user you specify is mapped to the command-execution JP1 user (JP1 user with the same name as the command-execution OS user) on the agent host on which the command is executed.

You can specify a character string of 1 to 63 bytes.

In Windows, if you want to ensure that a submit job is always executed by the local host user, specify the OS user name in the `host-name\user-name` format.

-jn *job-name*

Specify the name of the submit job you want to register.

You can specify a character string of 1 to 63 bytes. By default, the system assumes the first 63 bytes of the file name (excluding the path) of the execution file specified with the `-sc` option.

-pr *execution-priority*

Specify the execution priority.

You can specify 1 to 5. By default, the system assumes 1.

The following gives the values you can specify, and their meanings.

| Value | Priority for UNIX | Priority for Windows |
|-------|-------------------|------------------------------------|
| 1 | nice value + 20 | Lower than interactive processing |
| 2 | nice value + 10 | |
| 3 | nice value | Equal to interactive processing |
| 4 | nice value - 10 | Higher than interactive processing |

| Value | Priority for UNIX | Priority for Windows |
|-------|-------------------|------------------------------------|
| 5 | nice value - 20 | Higher than interactive processing |

For a UNIX host executing jobs, when users do not have superuser privileges, specifying an execution priority of 4 or 5 results in a privilege error at the time of job execution.

Supplementary note

Windows only supports three levels of priority. Specify one of the following three priority classes to start the job process:

- If the specified value is 1 or 2, the job process is executed when the system is idle (set `IDLE_PRIORITY_CLASS` as specified in Windows).
- If the specified value is 3, the job process is executed as a general process (set `NORMAL_PRIORITY_CLASS` as specified in Windows).
- If the specified value is 4 or 5, the job process is executed prior to the threads of processes assigned any of the above priority classes (set `HIGH_PRIORITY_CLASS` as specified in Windows).

For UNIX, the default `nice` value is the `nice` value of the JP1/AJS3 service that executed `jajs_spmd`. If no specific value is set for the `nice` value, 20 is assumed for the `nice` value.

When the specified value is 1 and the `nice` value is 20, the priority value is determined as follows:

$39 \approx 20$ (initial value) + 20 (increment)

If the value exceeds the range of the `nice` value (0 to 39), the maximum value is 39, and the minimum value is 0.

-sc *target-file-name*

For Windows, specify the name of an executable file on the agent host which will execute the job. For UNIX, specify the name of a script file on the agent host which will execute the job.

You can specify a character string of 1 to 511 bytes. You can use either an absolute or relative path to specify the file name. If you specify a relative path, the system assumes it to be a relative path from the work path for job execution or the path specified by the `PATH` environment variable. An effective value of the `PATH` environment variable differs, depending on the operating system of the job-executing host.

For a Windows host

System environment variable

For a UNIX host

`PATH` environment variable for job-executing OS users

The name of any execution file containing a space character must be enclosed in double quotation marks ("). For example, the `aaa bbb` name must be specified as follows: `"aaa bbb"`.

In Windows, if you execute a file whose extension is not `EXE`, `COM`, `CMD`, or `BAT`, and whose file name contains a space character, you must enclose the file name by double quotation marks (") and (\").

For example

```
jpqjjobsub -q q1 -sc "\"C:\PROGRAM FILES\HITACHI\SCRIPT\DATA\EXIT_0.SPT\""
```

-arg "arguments..."

Set an argument for the target file.

You can specify a character string of 1 to 1,023 bytes.

You can specify multiple arguments separated by at least one space character.

-w *work-path-name*

Specify the name of the work path (current path) for job execution using an absolute path.

You can specify a character string of 1 to 511 bytes. By default, the system assumes the following directory:

Windows

Work holder for agent process execution that is set in the agent's environmental setting

UNIX

Home directory of the job-executing user

-sh1 *shell-path-name*

Specify the full path of a job's startup shell.

You can specify a character string of 1 to 511 bytes.

As the startup shell, specify a shell that can be used to execute the script file in UNIX.

The startup shell specified in this option is used if an execution shell is not specified on the first line of the script file. The execution shell is also used to execute the script file in UNIX as if it were a startup shell. However, the shell specified on the first line of the script file is called the execution shell. If the execution shell is specified on the first line of the script file, the startup shell specified in this option is ignored.

If neither a startup shell nor an execution shell is specified, the login shell for the OS user who executes the command (contents of the `/etc/passwd` file on the agent host) is used. If a login shell is not defined either, `/bin/sh` is used.

-res *execution-locked-resource-name*

To disable concurrent execution of multiple submit jobs, set the same execution-locked resource name for each submit job.

You can specify a character string of 1 to 63 bytes.

For details about execution-locked resources, see *11.4.1(7) Exclusive control when executing submit jobs (execution-locked resource)* in the manual *JP1/Automatic Job Management System 3 Overview*.

-st *execution-start-time*

Set the local time for the command executing host at which execution of the submit job starts. If you specify a past time, the system assumes that you specify no time at which execution of the submit job starts (the submit job is placed into the waiting or running status immediately after being registered.)

You can specify the date and time in any of the following five formats:

1. *YYYY/MM/DD.hh:mm:ss*

If you register a submit job after the specified time, the system immediately places the submit job into the waiting or running status.

2. *day-of-week . hh : mm : ss*

If you register a submit job after the specified time on the specified day of the week, the system immediately places the submit job into the waiting or running status.

3. *hh:mm:ss*

If you register a submit job after the specified time, the system immediately places the submit job into the waiting or running status.

4. *YYYY/MM/DD*

The system assumes 00:00:00 on the specified day as the time at which execution of the submit job starts. If you submit a job after 00:00:00 on the specified day, the system immediately places the job into the waiting or running status.

5. *n*

The system places the submit job into the waiting or running status *n* days after the day on which the submit job is registered.

The following describes the meaning of each value:

- *YYYY*
Specify a year. You can specify 1980 to 2038.
- *MM*
Specify a month. You can specify 01 to 12.
- *DD*
Day. You can specify 01 to 31.
- *hh*
Specify hours. You can specify 00 to 23.
- *mm*
Specify minutes. You can specify 00 to 59.
- *ss*
Seconds. You can specify 00 to 59.
- *day-of-week*
You can specify sun, mon, tue, wed, thu, fri or sat.
- *n*
Specify the number of days. You can specify 0 to 366 (days).

-e1 *time-out-period*

You can use this option to specify the timeout value used to stop execution of a job if the job is unable to terminate. Specify in minutes a relative time from *execution-start-time*.

You can specify 1 and 1,440 minutes.

-si *standard-input-file-name*

Specify the name of the standard input file used for executing the job (the name of the standard input file existing on the agent host on which the job is executed).

You can specify a character string of 1 to 511 bytes. You can use either an absolute or relative path to specify the file name. If you specify a relative path, the system assumes it to be a relative path from the work path for job execution.

-rs {*q|h|d*}

Specify how the job is to be handled if the manager host cannot receive a job end notification because a problem has occurred on the agent host on which the job is being executed or because the agent process has terminated abnormally. By default, the system holds the job.

- q
Makes the job wait to be executed.
- h
Holds the job.
- d
Kills the job.

-so

Enables you to use the `jpqjobget` command to acquire job execution data in the standard output file after the execution of the job.

-son *standard-output-file-name*

To overwrite the standard output file created in the agent host with job information, specify the file name.

You can specify a character string of 1 to 511 bytes. You can use either an absolute or relative path to specify the file name. If you specify a relative path, the system assumes it to be a relative path from the work path for job execution.

For notes for defining the standard output file name, see *7.11.1 Notes on the standard output file and standard error output file* in the *JPI/Automatic Job Management System 3 System Design (Work Tasks) Guide*.

-soa *standard-output-file-name*

To add job information to the standard output file created in the agent host, specify the file name.

You can specify a character string of 1 to 511 bytes. You can use either an absolute or relative path to specify the file name. If you specify a relative path, the system assumes it to be a relative path from the work path for job execution.

For notes for defining the standard output file name, see *7.11.1 Notes on the standard output file and standard error output file* in the *JPI/Automatic Job Management System 3 System Design (Work Tasks) Guide*.

-se

Enables you to use the `jpqjobget` command to acquire job execution data in the standard error output file after the execution of the job.

-sen *standard-error-output-file-name*

To overwrite the standard error output file created in the agent host with error job information, specify the file name.

You can specify a character string of 1 to 511 bytes. You can use either an absolute or relative path to specify the file name. If you specify a relative path, the system assumes it to be a relative path from the work path for job execution.

For notes for defining the standard error output file name, see *7.11.1 Notes on the standard output file and standard error output file* in the *JPI/Automatic Job Management System 3 System Design (Work Tasks) Guide*.

-sea *standard-error-output-file-name*

To add error job information to the standard error output file created in the agent host, specify the file name.

You can specify a character string of 1 to 511 bytes. You can use either an absolute or relative path to specify the file name. If you specify a relative path, the system assumes it to be a relative path from the work path for job execution.

For notes for defining the standard error output file name, see *7.11.1 Notes on the standard output file and standard error output file* in the *JPI/Automatic Job Management System 3 System Design (Work Tasks) Guide*.

-ev *environment-variable-file-name*

When you use an environment variable file, specify one existing on the agent host.

You can specify a character string of 1 to 511 bytes. You can use either an absolute or relative path to specify the file name. If you specify a relative path, the system assumes it to be a relative path from the work path for job execution.

For notes on defining environment variables see *A. Notes on Defining Environment Variables and an Environment Variable File*.

-env *environment-variable-name=value*

Set an environment variable.

When specifying environment variables, use the following precautions:

You can specify multiple `-env` options by using one or more space characters to separate each option specification (`-env environment-variable-name=value`). Note that the total length of the *environment-variable-name=value* specifications must not exceed 20 KB.

If the same environment variable as set with this option is defined in the environment variable file, the contents set with this option are valid.

- You can specify multiple environment variables.

The following shows an example specification of the `-env` option and how to calculate the total number of bytes:

Example for specifying the `-env` option

```
-env Δ a=1 Δ -env Δ b=2 Δ -env Δ C=3
```

Legend:

Δ : One-byte space character

How to calculate the total number of bytes

In this example, the total number of bytes (13 bytes) is calculated by adding two bytes to the sum of the number of bytes for the underlined sections.

For notes on defining environment variables see *A. Notes on Defining Environment Variables and an Environment Variable File*.

-h

Holds a submit job when it is registered.

-t *transfer-source-file-name* [=transfer-destination-file-name]

If you reference the file related to job execution, specify the name of the file to be transferred. Specify the file name used in the transfer destination if needed. It is required, however, during linkage with JP1/OJE for VOS3.

For *transfer-source-file-name*, specify a file that exists on the host from which the job is submitted. The transfer source file is transferred to an agent host, or JP1/OJE for VOS3 host as a file with the name specified for *transfer-destination-file-name*. If you specify a transfer destination file name, the transfer destination file will not be deleted after the end of job execution.

You can specify a character string of 1 to 511 bytes for the transfer destination file. You can use either an absolute or relative path to specify the file name. If you specify a relative path, the system assumes it to be a relative path from the work path for job execution. If you omit the name of a transfer destination file, the system assumes the `$JP1AJS2_JPQTEMPxx$` variable, where the *xx* part shows the transfer file's number, ranging from 01 to 32. If you

specify this variable in the `-arg` option, there is no need to be concerned about the transfer destination file name when you use the file. After the job is executed, the transfer destination file that has been created temporarily is deleted.

For a UNIX host, you can also specify this variable in the `-sc` option to execute the job. For a Windows host, you cannot specify this variable in the `-sc` option. If the variable is specified, it will be impossible to start the job.

You can specify up to 32 options (including the `-td` option) at the same time.

Also see the explanation for the `-td` option.

`-td` *transfer-source-file-name* [=*transfer-destination-file-name*]

If you reference the file related to job execution, specify the name of the file to be transferred. (Specify the file name used in the transfer destination if needed.) Unlike the `-t` option, this option deletes the transfer destination file in the destination host after the end of job execution.

For *transfer-source-file-name*, specify a file that exists on the host from which the job is submitted. The transfer source file is transferred to an agent host as a file with the name specified for *transfer-destination-file-name*.

You can specify a character string of 1 to 511 bytes for the transfer destination file. You can use either an absolute or relative path to specify the file name. If you specify a relative path, it becomes a path relative to the work path for job execution. If you omit the name of a transfer destination file, the system assumes the `$JP1AJS2_JPQTEMPxx$` variable, where the *xx* part shows the transfer file's number, ranging from 01 to 32. If you specify this variable in the `-arg` option, there is no need to be concerned about the file name for the transfer destination when you use the file. After the job is executed, the transfer destination file that has been created temporarily is deleted.

For a UNIX host, you can also specify this variable in the `-sc` option to execute the job. For a Windows host, you cannot specify this variable in the `-sc` option. If the variable is specified, it will be impossible to start the job.

You can specify up to 32 options (including the `-t` option) at the same time.

Notes

1. Do not specify redirection for a command argument. To output the standard output file, specify the `-so`, `-son`, or `-soa` option. To output the standard error output file, specify the `-se`, `-sen`, or `-sea` option. You cannot acquire job information correctly if you specify redirection with the above options.
2. When you execute multiple jobs simultaneously on a single agent host, do not specify the same name for the standard output file, standard error output file, and transfer destination file name. Otherwise, the specified file may get corrupted, preventing the job from being executed.
3. If a file of several megabytes is transferred either during job registration or as the result of job information collection, the transfer may fail or take time.
4. You can specify only text files for the standard input file, the standard output file, the standard error output file, and transfer files.
5. JP1/AJS3 converts character codes when a file is transferred from the manager host to the agent host. It also converts character codes when a result file (standard input file, standard output file, or standard error output file) is transferred from the agent host to the manager host. In both cases, the character codes of the JP1/AJS3 service at the transfer destination are converted, rather than the character codes of the user who executed the command.

As an example, suppose you start the JP1/AJS3 service on a manager host that uses Shift-JIS and start the JP1/AJS3 service on an agent host that uses EUC, and then create a transfer file in Shift-JIS on the manager host. When you transfer the file to the agent host, the file will be created as a EUC file.

For details about the settings for character encoding in JP1/AJS3, see the description about how to change the character code set in *13.4.1 Setting the language environment* in the *JP1/Automatic Job Management System 3 Configuration Guide*.

6. For details about the characters that can be used in the data contained in the standard input file, standard output file, standard error output file, or in a transfer file, see *2.4.2(7)(a) Available characters* in the *JP1/Automatic Job Management System 3 System Design (Configuration) Guide*.
7. The following gives the options you can specify for linkage with JP1/OJE for VOS3. The other options are ignored even if they are specified.

```
-mh
-q
-jn
-sc
-arg
-t
```

Return values

| | |
|-----|--|
| 0 | Normal end |
| 1 | Invalid parameter value |
| 2 | An attempt to register a submit job failed due to an internal cause of the host on which a submit was requested. |
| 5 | Initialization has failed. <ul style="list-style-type: none"> • The definition of the logical host name or the common definition information contains an error. |
| 6 | Memory became insufficient on the host on which a submit was requested. |
| 7 | A logical error occurred on the host on which a submit was requested. |
| 8 | As the transfer source file or its file path does not exist, you cannot open the file. |
| 9 | As you do not have the privilege required to access the transfer source file, you cannot open it. |
| 10 | As the transfer source file is used by another process, you cannot open it. |
| 11 | You cannot open the transfer source file owing to a cause other than return values 8, 9 and 10. |
| 12 | The transfer source file could not be loaded successfully owing to a cause other than return values 8, 9 and 10. |
| 100 | The manager host cannot be connected for TCP/IP communication. <ul style="list-style-type: none"> • As TCP/IP is not validly set, the manager host cannot be connected. • The manager host name is invalid, or the manager host process stopped. |
| 102 | The IP address could not be solved successfully by the manager host name. |
| 200 | The manager host does not accept the submit job registered. <ul style="list-style-type: none"> • The manager host is now being started, now being stopped, has stopped, or is running in the reduced-operation mode. |
| 201 | You cannot use a specified queue. <ul style="list-style-type: none"> • The specified queue is not found. |
| 202 | No response from the manager host |
| 203 | The submit job could not be registered successfully due to an internal cause of the manager host. |
| 204 | The specified queue is closed. |
| 205 | As the number of submit jobs in the specified queue has reached the limit, no more submit jobs can be registered. |
| 206 | You do not have the privilege required to submit a job. |

| | |
|-----|---|
| 219 | The manager host is busy. |
| 220 | Insufficient manager host memory |
| 221 | Invalid user information about JP1/OJE for VOS3 |
| 222 | A fatal error has occurred. <ul style="list-style-type: none"> • A system call error has occurred. |
| 223 | The manager host encountered a logic error. |
| 225 | An error occurred after the submit job was registered. (Registration of the submit job terminated normally. However, because the destination manager host did not return a job number, the result was that hold, cancellation, or other such operations that use the job number could not be performed for the job.) |
| 226 | Invalid execution environment |
| 227 | Job information having the same ID already exists in the job execution environment database. |
| 228 | The transfer destination file could not be created successfully in the manager host. |
| 229 | The transfer destination file could not be written successfully in the manager host. |
| 241 | Failed to automatically define the agent. |

jpqqueueadd

Format

```
jpqqueueadd
  [-mh manager-host-name]
  -q queue-name
  [-mj maximum-number-of-jobs-in-queues]
  [-wj warning-value-for-jobs-count-in-queues]
  [-en {open|close}]
  [-ex {open|close}]
```

Description

Adds a queue.

Execution privileges

You must have the following JP1 privilege:

- JP1_JPQ_Admin privilege

Arguments

-mh *manager-host-name*

Specify a manager host name to which a queue is to be added.

You can specify a character string of 1 to 255 bytes.

By default, the system assumes the local host name.

-q *queue-name*

Specify a queue name you want to add.

You can specify a character string of 1 to 63 bytes.

Note that agent names are not case sensitive, but that queue names are.

-mj *maximum-number-of-jobs-in-queues*

Specify the maximum number of jobs which can be accumulated in the queue.

You can specify a value between 1 and 4,294,967,295.

If you omit this option, the system assumes 4,294,967,295.

This setting also includes the number of jobs that are actually being executed.

The number of jobs is the sum of the values of `QUEUING` and `EXECUTING` displayed by the `jpqqueshow` command with the `-q` option specified.

In spite of this setting, however, the submit process will fail if the queue still contains as many jobs as the system's maximum number of jobs.

-wj *warning-value-for-jobs-count-in-queues*

Specify a warning value to inform you that the number of jobs in a particular queue is nearing the maximum number of jobs that can be stored in the queue.

You can specify a value of 1 to 4,294,967,295; however, the value must be equal to, or smaller than, the value specified by the `-mj` option.

This setting also includes the number of jobs that are actually being executed.

The number of jobs is the sum of the values of `QUEUING` and `EXECUTING` displayed by the `jpqqshow` command with the `-q` option specified.

By default, the system assumes the value specified in the `-mj` option. Without the `-mj` option specified, the system assumes the value of 4,294,967,295.

-en {open|close}

Specify the status of the job entrance in the queue.

- `open`
Opens the reception port.
- `close`
Closes the reception port.

By default, the system assumes `open`.

-ex {open|close}

Specify the status of the job exit in the queue.

- `open`
Opens the takeout port.
- `close`
Closes the takeout port.

By default, the system assumes `open`.

Note

This command cannot be used for a request from JP1/AJS3 to JP1/OJE for VOS3.

Return values

| | |
|---|--|
| 0 | Normal end |
| 1 | Invalid parameter value |
| 2 | The queue could not be added successfully owing to an internal cause of the adding requester. |
| 5 | Initialization has failed. <ul style="list-style-type: none">• The definition of the logical host name or the environment setting contains an error. |
| 6 | Queue adding requester's insufficient memory |
| 7 | The queue adding requester encountered a logic error. |

| | |
|-----|--|
| 100 | The manager host cannot be connected for TCP/IP communication. <ul style="list-style-type: none"> • As TCP/IP is not validly set, the manager host cannot be connected. • The manager host name is invalid, or the manager host process stopped. |
| 102 | The IP address could not be solved successfully by the manager host name. |
| 200 | The manager host does not accept a queue adding request. <ul style="list-style-type: none"> • The manager host is now being started, now being stopped, has stopped, or is running in the reduced-operation mode. |
| 202 | No response from the manager host |
| 203 | The queue could not be added successfully owing to an internal cause of the manager host. |
| 206 | You do not have the privilege required to add the queue. |
| 219 | The manager host is busy. |
| 220 | Insufficient manager host memory |
| 222 | A fatal error has occurred. <ul style="list-style-type: none"> • A system call error has occurred. |
| 223 | The manager host encountered a logic error. |
| 224 | You have issued a request to a host other than JP1/AJS3. |
| 226 | Invalid execution environment |
| 232 | The additional queue has the same name as an existing queue. |
| 235 | The maximum number of queue definitions has been exceeded. |

jpqqealt

Format

```
jpqqealt
  [-mh manager-host-name]
  {-q queue-name|-ah agent-host-name}
  { [-mj maximum-number-of-jobs-in-queues] |
    [-wj warning-value-for-jobs-count-in-queues] |
    [-nq post-change-queue-name] }
  [-em]
```

Description

Changes queue definitions.

Execution privileges

You must have the following JP1 privilege:

- JP1_JPQ_Admin privilege

However, specifying the `-em` option requires the following privileges (but does not require JP1_JPQ_Admin privileges).

- Windows: Administrators privileges
- UNIX: Superuser privileges

Arguments

`-mh` *manager-host-name*

Specify the name of a manager host that contains the queue whose definition is to be changed.

You can specify a character string of 1 to 255 bytes.

By default, the system assumes the local host name.

When you specify this option together with the `-em` option, you can specify only two types of host names: the local host name and the logical host name on the local host. Specifying any other value results in an error (error code: 25). Also note that you cannot specify an alias host name in the `-mh` option.

`-q` *queue-name*

Specify the queue name you want to change.

You can specify a character string of 1 to 63 bytes.

`-ah` *agent-host-name*

When you want to change the definition of a default queue, specify the corresponding agent host name that has been registered on the manager host. When an agent host is registered, the default queue is created with the same name as the agent host.

You can specify a character string of 1 to 255 bytes.

You cannot specify this option (you cannot change the name of the default queue) if you specify the `-nq` option.

`-mj` *maximum-number-of-jobs-in-queues*

Specify the maximum number of jobs which can be accumulated in the queue.

You can specify a value between 1 and 4,294,967,295.

This setting also includes the number of jobs that are actually being executed.

The number of jobs is the sum of the values of `QUEUING` and `EXECUTING` displayed by the `jpqqshow` command with the `-q` option specified.

By default, the system does not change the maximum value of jobs.

`-wj` *warning-value-for-jobs-count-in-queues*

Specify a warning value to inform you that the number of jobs in a queue is nearing the maximum number of jobs that can be stored in the queue.

You can specify a value of 1 to 4,294,967,295; however, the value must be equal to, or smaller than, the value specified by the `-mj` option.

This setting also includes the number of jobs that are actually being executed.

The number of jobs is the sum of the values of `QUEUING` and `EXECUTING` displayed by the `jpqqshow` command with the `-q` option specified.

By default, the system does not change the warning value.

`-nq` *post-change-queue-name*

When renaming a queue, specify its new name.

You can specify a character string of 1 to 63 bytes.

By default, the system does not change the queue name.

This option can be specified only when the `-q` option is specified. You cannot specify it together with the `-ah` option (you cannot rename the default queue).

`-em`

Specify this option for emergency execution.

Specifying this option enables emergency execution upon failure because a request is sent to a different communication path that is not used under normal conditions.

When you specify this option, note that you cannot assign an IP address to the manager host name.

Notes

1. This command cannot be used for a request from JP1/AJS3 to JP1/OJE for VOS3.
2. Be sure to specify at least one of the `-mj`, `-wj`, and `-nq` options.
3. The maximum value for the number of jobs specified in the `-mj` option is equal to, or larger than, the warning value for the number of jobs specified in the `-wj` option.

If you change the maximum or warning value regarding the number of jobs, the system compares it with the current setting. Therefore, if you want to change only the maximum value with the `-mj` option, make sure that you choose a value equal to, or greater than, the current warning value regarding the number of jobs. If you want to change only the warning value with the `-wj` option, make sure that you choose a value equal to, or smaller than, the current maximum value regarding the number of jobs.

4. Even if the maximum value for the number of jobs is changed to a value smaller than the current number of jobs being queued, the system executes those jobs being queued. Note, however, that the system will not accept new jobs until the number of jobs being queued falls below the maximum value for the number of jobs after the change.
For example, suppose that there are 12 jobs being queued. If you change the maximum number of jobs to 10, the system executes up to 12 jobs, but will not accept new jobs until the number of jobs being queued goes down to 9 or fewer.
5. An error occurs if you change the name of a queue while the queue still contains jobs.
6. You cannot rename the default queue.
7. You should use the `-em` option for the sole purpose of recovering from an agent host failure. You should avoid specifying the `-em` option under any normal condition, because you may fail to take corrective action when a failure actually occurs.

Return values

| | |
|-----|---|
| 0 | Normal end |
| 1 | Invalid parameter value |
| 2 | An attempt to change the queue definition failed due to an internal cause of the host on which the <code>jpqqqueuealt</code> command was executed. |
| 5 | Initialization has failed. <ul style="list-style-type: none"> • The definition of the logical host name or the environment setting contains an error. |
| 6 | Memory became insufficient on the host on which the <code>jpqqqueuealt</code> command was executed. |
| 7 | A logical error occurred on the host on which the <code>jpqqqueuealt</code> command was executed. |
| 25 | The specified manager host name is neither the local host name nor the logical host name. |
| 100 | The host on which the <code>jpqqqueuealt</code> command was executed cannot connect to the manager host via TCP/IP communication. <ul style="list-style-type: none"> • The host on which the <code>jpqqqueuealt</code> command was executed cannot connect to the manager host because TCP/IP is not set up correctly. • The manager host name is invalid, or the manager host process stopped. |
| 102 | The IP address could not be resolved from the name of the manager host on which the <code>jpqqqueuealt</code> command was executed. |
| 200 | The manager host does not accept a queue changing request. <ul style="list-style-type: none"> • The manager host is now being started, now being stopped, has stopped, or is running in the reduced-operation mode. |
| 201 | You cannot use a specified queue. <ul style="list-style-type: none"> • The specified queue is not found. |
| 202 | No response from the manager host |
| 203 | The queue could not be changed successfully owing to an internal cause of the manager host. |
| 206 | You do not have the privilege required to change the queue. |
| 219 | The manager host is busy. |
| 220 | Insufficient manager host memory |
| 222 | A fatal error has occurred. <ul style="list-style-type: none"> • A system call error has occurred. |

| | |
|-----|---|
| 223 | The manager host encountered a logic error. |
| 224 | You have issued a request to a host other than JP1/AJS3. |
| 226 | Invalid execution environment |
| 232 | The post-change queue has the same name as an existing queue. |
| 233 | The queue contains jobs at the time of a queue name change. |
| 237 | The warning value for the number of jobs is greater than its maximum value. |
| 238 | The maximum value for the number of jobs is greater than its warning value. |

jpqqueclose

Format

```
jpqqueclose
  [-mh manager-host-name]
  {-q queue-name|-ah agent-host-name}
  [{-en|-ex}]
  [-em]
```

Description

Closes the job inlet or outlet for a queue.

Execution privileges

You must have either of the following JP1 privileges:

- JP1_JPQ_Admin privilege
- JP1_JPQ_Operator privilege

However, specifying the `-em` option requires the following privileges (but does not require JP1_JPQ_Admin or JP1_JPQ_Operator privileges).

- Windows: Administrators privileges
- UNIX: Superuser privileges

Arguments

-mh *manager-host-name*

Specify the name of the manager host containing a queue to be closed.

You can specify a character string of 1 to 255 bytes.

By default, the system assumes the local host name.

When you specify this option together with the `-em` option, you can specify only two types of host names: the local host name and the logical host name on the local host. Specifying any other value results in an error (error code: 25). Also note that you cannot specify an alias host name in the `-mh` option.

-q *queue-name*

Specify the name of a queue to be closed.

You can specify a character string of 1 to 63 bytes.

-ah *agent-host-name*

When you want to close a default queue, specify the corresponding agent host name that has been registered on the manager host. When an agent host is registered, the default queue is created with the same name as the agent host.

You can specify a character string of 1 to 255 bytes.

-en

Closes the queue entrance.

-ex

Closes the queue exit.

-em

Specify this option for emergency execution.

Specifying this option enables emergency execution upon failure because a request is sent to a different communication path that is not used under normal conditions.

When you specify this option, note that you cannot assign an IP address to the manager host name.

Notes

1. This command cannot be used for a request from JP1/AJS3 to JP1/OJE for VOS3.
2. You should use the `-em` option for the sole purpose of recovering from an agent host failure. You should avoid specifying the `-em` option under any normal condition, because you may fail to take corrective action when a failure actually occurs.

Return values

| | |
|-----|--|
| 0 | Normal end |
| 1 | Invalid parameter value |
| 2 | An attempt to close a queue failed due to an internal cause of the host on which the <code>jpqueueclose</code> command was executed. |
| 5 | Initialization has failed. <ul style="list-style-type: none">• The definition of the logical host name or the environment setting contains an error. |
| 6 | Memory became insufficient on the host on which the <code>jpqueueclose</code> command was executed. |
| 7 | A logical error occurred on the host on which the <code>jpqueueclose</code> command was executed. |
| 25 | The specified manager host name is neither the local host name nor the logical host name. |
| 100 | The host on which the <code>jpqueueclose</code> command was executed cannot connect to the manager host via TCP/IP communication. <ul style="list-style-type: none">• The host on which the <code>jpqueueclose</code> command was executed cannot connect to the manager host because TCP/IP is not set up correctly.• The manager host name is invalid, or the manager host process stopped. |
| 102 | The IP address could not be resolved from the name of the manager host on which the <code>jpqueueclose</code> command was executed. |
| 200 | The manager host does not accept a queue closing request. <ul style="list-style-type: none">• The manager host is now being started, now being stopped, has stopped, or is running in the reduced-operation mode. |
| 201 | You cannot use a specified queue. <ul style="list-style-type: none">• The specified queue is not found. |
| 202 | No response from the manager host |
| 203 | The queue could not be closed successfully owing to an internal cause of the manager host. |
| 206 | You do not have the privilege required to close the queue. |
| 219 | The manager host is busy. |
| 220 | Insufficient manager host memory |

| | |
|-----|---|
| 222 | A fatal error has occurred. <ul style="list-style-type: none">• A system call error has occurred. |
| 223 | The manager host encountered a logic error. |
| 224 | You have issued a request to a host other than JP1/AJS3. |
| 226 | Invalid execution environment |

Additional information

Even with a queue closed, you can delete, hold and release a job in it.

jpqquedel

Format

```
jpqquedel  
  [-mh manager-host-name]  
  -q queue-name
```

Description

Deletes queues.

To execute this command, a user must have the JP1_JPQ_Admin privilege.

Execution privileges

You must have the following JP1 privilege:

- JP1_JPQ_Admin privilege

Arguments

-mh *manager-host-name*

Specify the name of a manager host from which you want to delete the queue.

You can specify a character string of 1 to 255 bytes.

By default, the system assumes the local host name.

-q *queue-name*

Specify the queue name you want to delete.

You can specify a character string of 1 to 63 bytes.

Notes

- This command cannot be used for a request from JP1/AJS3 to JP1/OJE for VOS3.
- Before executing this command, use the `jpqqueeclose` command to close the job reception port for the queue you want to delete, so that the system will not accept new jobs. Confirm that the jobs in the queues have been executed. You cannot delete the queue if it has a job that is being executed, assuming that the job is a standard job (PC, UNIX, or QUEUE), custom job, or action job.
If you delete the queue, the jobs to be deleted, those being held, and those waiting within it are cancelled.

Return values

| | |
|---|--|
| 0 | Normal end |
| 1 | Invalid parameter value |
| 2 | The queue could not be deleted successfully owing to an internal cause of the requester. |
| 5 | Initialization has failed. <ul style="list-style-type: none">• The definition of the logical host name or the environment setting contains an error. |

| | |
|-----|--|
| 6 | Queue deleting requester's insufficient memory |
| 7 | The queue deleting requester encountered a logic error. |
| 100 | The manager host cannot be connected for TCP/IP communication. <ul style="list-style-type: none"> • As TCP/IP is not validly set, the manager host cannot be connected. • The manager host name is invalid, or the manager host process stopped. |
| 102 | The IP address could not be solved successfully by the manager host name. |
| 200 | The manager host does not accept a queue deleting request. <ul style="list-style-type: none"> • The manager host is now being started, now being stopped, has stopped, or is running in the reduced-operation mode. |
| 201 | You cannot use a specified queue. <ul style="list-style-type: none"> • The specified queue is not found. |
| 202 | No response from the manager host |
| 203 | The queue could not be deleted successfully owing to an internal cause of the manager host. |
| 206 | You do not have the privilege required to delete the queue. |
| 219 | The manager host is busy. |
| 220 | Insufficient manager host memory |
| 222 | A fatal error has occurred. <ul style="list-style-type: none"> • A system call error has occurred. |
| 223 | The manager host encountered a logic error. |
| 224 | You have issued a request to a host other than JP1/AJS3. |
| 226 | Invalid execution environment |
| 233 | There are jobs being executed (which are standard jobs, custom jobs, or action jobs). |

jpqqeopen

Format

```
jpqqeopen  
  [-mh manager-host-name]  
  {-q queue-name|-ah agent-host-name}  
  [{-en|-ex}]  
  [-em]
```

Description

Opens the job inlet or outlet for a queue.

Execution privileges

You must have either of the following JP1 privileges:

- JP1_JPQ_Admin privilege
- JP1_JPQ_Operator privilege

However, specifying the `-em` option requires the following privileges (but does not require JP1_JPQ_Admin or JP1_JPQ_Operator privileges).

- Windows: Administrators privileges
- UNIX: Superuser privileges

Arguments

-mh *manager-host-name*

Specify the name of the manager host containing a queue to be opened.

You can specify a character string of 1 to 255 bytes.

By default, the system assumes the local host name.

When you specify this option together with the `-em` option, you can specify only two types of host names: the local host name and the logical host name on the local host. Specifying any other value results in an error (error code: 25). Also note that you cannot specify an alias host name in the `-mh` option.

-q *queue-name*

Specify the name of a queue to be opened.

You can specify a character string of 1 to 63 bytes.

-ah *agent-host-name*

When you want to open a default queue, specify the corresponding agent host name that has been registered on the manager host. When an agent host is registered, the default queue is created with the same name as the agent host.

You can specify a character string of 1 to 255 bytes.

-en

Opens the queue entrance.

-ex

Opens the queue exit.

-em

Specify this option for emergency execution.

Specifying this option enables emergency execution upon failure because a request is sent to a different communication path that is not used under normal conditions.

When you specify this option, note that you cannot assign an IP address to the manager host name.

Notes

1. This command cannot be used for a request from JP1/AJS3 to JP1/OJE for VOS3.
2. You should use the `-em` option for the sole purpose of recovering from an agent host failure. You should avoid specifying the `-em` option under any normal condition, because you may fail to take corrective action when a failure actually occurs.

Return values

| | |
|-----|--|
| 0 | Normal end |
| 1 | Invalid parameter value |
| 2 | An attempt to open a queue failed due to an internal cause of the host on which the <code>jpqqqueueopen</code> command was executed. |
| 5 | Initialization has failed. <ul style="list-style-type: none">• The definition of the logical host name or the environment setting contains an error. |
| 6 | Memory became insufficient on the host on which the <code>jpqqqueueopen</code> command was executed. |
| 7 | A logical error occurred on the host on which the <code>jpqqqueueopen</code> command was executed. |
| 25 | The specified manager host name is neither the local host name nor the logical host name. |
| 100 | The host on which the <code>jpqqqueueopen</code> command was executed cannot connect to the manager host via TCP/IP communication. <ul style="list-style-type: none">• The host on which the <code>jpqqqueueopen</code> command was executed cannot connect to the manager host because TCP/IP is not set up correctly.• The manager host name is invalid, or the manager host process stopped. |
| 102 | The IP address could not be resolved from the name of the manager host on which the <code>jpqqqueueopen</code> command was executed. |
| 200 | The manager host does not accept a queue opening request. <ul style="list-style-type: none">• The manager host is now being started, now being stopped, has stopped, or is running in the reduced-operation mode. |
| 201 | You cannot use a specified queue. <ul style="list-style-type: none">• The specified queue is not found. |
| 202 | No response from the manager host |
| 203 | The queue could not be opened successfully owing to an internal cause of the manager host. |
| 206 | You do not have the privilege required to open the queue. |
| 219 | The manager host is busy. |
| 220 | Insufficient manager host memory |

| | |
|-----|---|
| 222 | A fatal error has occurred. <ul style="list-style-type: none">• A system call error has occurred. |
| 223 | The manager host encountered a logic error. |
| 224 | You have issued a request to a host other than JP1/AJS3. |
| 226 | Invalid execution environment |

jpqqeshow

Format

```
jpqqeshow
  [-mh manager-host-name]
  {-q queue-name|-ah agent-host-name|-a|-ad|-n}
  [-em]
```

Description

Outputs queue information (including queue names, limit and warning values on the maximum number of submit jobs, and the number of submit jobs) to the standard output.

You can also queue information about the JP1/OJE for VOS3 hosts.

You can also output queue information about the AS/400 system. You can specify only the `-mh` and `-n` options for the AS/400 system.

Execution privileges

You must have any of the following JP1 privileges:

- JP1_JPQ_Admin privilege
- JP1_JPQ_Operator privilege (`-ad` option not allowed)
- JP1_JPQ_User privilege (`-ad` option not allowed)

However, specifying the `-em` option requires the following privileges (but does not require JP1_JPQ_Admin, JP1_JPQ_Operator, or JP1_JPQ_User privileges).

- Windows: Administrators privileges
- UNIX: Superuser privileges

Arguments

`-mh` *manager-host-name*

Specify the name of the manager host containing the queue whose queue information is to be output.

You can specify a character string of 1 to 255 bytes.

By default, the system assumes the local host name.

When you specify this option together with the `-em` option, you can specify only two types of host names: the local host name and the logical host name on the local host. Specifying any other value results in an error (error code: 25). Also note that you cannot specify an alias host name in the `-mh` option.

`-q` *queue-name*

Specify the name of the queue whose queue information is to be output.

You can specify a character string of 1 to 63 bytes.

This option cannot be specified for a request from JP1/AJS3 to JP1/OJE for VOS3.

-ah agent-host-name

When you want to output information about a default queue, specify the corresponding agent host name that has been registered on the manager host. When an agent host is registered, the default queue is created with the same name as the agent host.

You can specify a character string of 1 to 255 bytes.

This option cannot be specified for a request from JP1/AJS3 to JP1/OJE for VOS3.

-a

Outputs all queue information on the manager host set with the `-mh` option (except for default queue information).

This option cannot be specified for a request from JP1/AJS3 to JP1/OJE for VOS3.

-ad

Outputs all queue information on the manager host set with the `-mh` option (including default queue information).

This option can be specified by only users having the JP1_JPQ_Admin privilege. This option cannot be specified for a request from JP1/AJS3 to JP1/OJE for VOS3.

-n

As queue information, outputs the names of all the queues in the manager host set with the `-mh` option (excluding information about the default queue).

-em

Specify this option for emergency execution.

Specifying this option enables emergency execution upon failure because a request is sent to a different communication path that is not used under normal conditions.

When you specify this option, note that you cannot assign an IP address to the manager host name.

Notes

- For the `-a` and `-ad` options, the queue name output limit is 21 bytes. If the queue name consists of more than 21 bytes, the 20th and subsequent bytes are ". .".
- You should use the `-em` option for the sole purpose of recovering from an agent host failure. You should avoid specifying the `-em` option under any normal condition, because you may fail to take corrective action when a failure actually occurs.

Return values

| | |
|---|--|
| 0 | Normal end |
| 1 | Invalid parameter value |
| 2 | An attempt to open a queue failed due to an internal cause of the host on which the <code>jpqqshow</code> command was executed. |
| 5 | Initialization has failed. <ul style="list-style-type: none">• The definition of the logical host name or the environment setting contains an error. |
| 6 | Memory became insufficient on the host on which the <code>jpqqshow</code> command was executed. |
| 7 | A logical error occurred on the host on which the <code>jpqqshow</code> command was executed. |

| | |
|-----|---|
| 25 | The specified manager host name is neither the local host name nor the logical host name. |
| 100 | The host on which the <code>jpqqshow</code> command was executed cannot connect to the manager host via TCP/IP communication. <ul style="list-style-type: none"> The host on which the <code>jpqqshow</code> command was executed cannot connect to the manager host because TCP/IP is not set up correctly. The manager host name is invalid, or the manager host process stopped. |
| 102 | The IP address could not be resolved from the name of the manager host on which the <code>jpqqshow</code> command was executed. |
| 200 | The manager host does not request output queue information. <ul style="list-style-type: none"> The manager host is now being started, now being stopped, has stopped, or is running in the reduced-operation mode. |
| 201 | You cannot use a specified queue. <ul style="list-style-type: none"> The specified queue is not found. |
| 202 | No response from the manager host |
| 203 | Queue information could not be output successfully owing to an internal cause of the manager host. |
| 206 | You do not have the privilege required to output queue information. |
| 212 | Queue information could not be output successfully because the process of adding or changing agent hosts or queues is under way. |
| 213 | The manager host contains no queue. |
| 219 | The manager host is busy. |
| 220 | Insufficient manager host memory |
| 222 | A fatal error has occurred. <ul style="list-style-type: none"> A system call error has occurred. |
| 223 | The manager host encountered a logic error. |
| 224 | You have issued a queue information output request to an unsupported host. |
| 226 | Invalid execution environment |

Output example 1

The following gives an example of file output when you specify the `-q` or `-ah` option.

```

QUEUE : a : agent1.software.hitachi.co.jp
MAXQUEUE : 10
WARNQUEUE : 9
ENTRYSTATUS : CLOSE
EXITSTATUS : OPEN
QUEUEING : 3
EXECUTING : 1
LINKAGENT : agent3:1 agent4:2

```

The following shows the meaning of the output.

QUEUE

Indicates queue information in the format of *queue-type*: *queue-name* (or *agent-host-name*).

The queue types are:

- `q`: Queue
- `a`: Agent host

MAXQUEUE

Indicates the maximum number of jobs submitted.
10 bytes of data are output.

WARNQUEUE

Indicates a warning value on the number of jobs submitted.
10 bytes of data are output.

ENTRYSTATUS

Indicates the status of a queue entrance.

- OPEN: Open
- CLOSE: Closed

EXITSTATUS

Indicates the status of a queue exit.

- OPEN: Open
- CLOSE: Closed

QUEUING

Indicates the number of already submit jobs (excluding the number of jobs currently executed).

EXECUTING

Indicates the number of jobs being executed.

LINKAGENT

Indicates information on a connected agent host in the format of *connected-agent-host-name:priority*.

Output example 2

The following gives an example of file output when you set the `-a` or `-ad` option.

| T | QUEUE | MAXQUEUE | WARNQUEUE | ENT | EXIT | QUEUING | EXECUTING |
|---|------------------------|----------|-----------|-------|-------|---------|-----------|
| q | batchqueuealongqueue.. | 5 | 3 | OPEN | OPEN | 2 | 1 |
| q | batch2 | 5 | 5 | OPEN | CLOSE | 2 | 1 |
| a | agent1.software.hit.. | 10 | 9 | CLOSE | OPEN | 3 | 4 |
| a | agent2 | 10 | 9 | CLOSE | CLOSE | 3 | 4 |

The following shows the meaning of the output.

T

Indicates a queue type.

- q: Queue
- a: Agent host

QUEUE

Indicates a queue name (or an agent host name).

21 bytes of data are output.

MAXQUEUE

Indicates the maximum number of jobs submitted.

WARNQUEUE

Indicates a warning value on the number of jobs submitted.

ENT

Indicates the status of a queue entrance.

- OPEN: Open
- CLOSE: Closed

EXIT

Indicates the status of a queue exit.

- OPEN: Open
- CLOSE: Closed

QUEUING

Indicates the number of already submit jobs (excluding the number of jobs currently executed).

EXECUTING

Indicates the number of jobs being executed.

Output example 3

The following gives an example of file output when you set the `-n` option.

```
QUEUE
-----
batchqueue1longqueuename
batch2
```

The following gives the meanings of output contents.

QUEUE

Indicates a queue name.

jpqresadd

Format

```
jpqresadd
  [-mh manager-host-name]
  -res execution-locked-resource-name
```

Description

Adds execution-locked resources.

To execute this command, a user must have the JP1_JPQ_Admin privilege.

Execution privileges

You must have the following JP1 privilege:

- JP1_JPQ_Admin privilege

Arguments

-mh *manager-host-name*

Specify the name of a manager host to which you want to add execution-locked resources.

You can specify a character string of 1 to 255 bytes.

By default, the system assumes the local host name.

-res *execution-locked-resource-name*

Specify the execution-locked resource name you want to add.

You can specify a character string of 1 to 63 bytes.

If the execution-locked resource name you want to specify contains a space character, enclose the name in double quotation marks ("").

Note

This command cannot be used for a request from JP1/AJS3 to JP1/OJE for VOS3.

Return values

| | |
|---|--|
| 0 | Normal end |
| 1 | Invalid parameter value |
| 2 | The execution-locked resource could not be added successfully owing to an internal cause of the requester. |
| 5 | Initialization has failed. <ul style="list-style-type: none">• The definition of the logical host name or the environment setting contains an error. |
| 6 | Execution-locked resource adding requester's insufficient memory |
| 7 | The execution-locked resource adding requester encountered a logic error. |

| | |
|-----|--|
| 100 | The manager host cannot be connected for TCP/IP communication. <ul style="list-style-type: none"> • As TCP/IP is not validly set, the manager host cannot be connected. • The manager host name is invalid, or the manager host process stopped. |
| 102 | The IP address could not be solved successfully by the manager host name. |
| 200 | The manager host does not accept an execution-locked resource adding request. <ul style="list-style-type: none"> • The manager host is now being started, now being stopped, has stopped, or is running in the reduced-operation mode. |
| 202 | No response from the manager host |
| 203 | The execution-locked resource could not be added successfully owing to an internal cause of the manager host. |
| 206 | You do not have the privilege required to add the execution-locked resource. |
| 219 | The manager host is busy. |
| 220 | Insufficient manager host memory |
| 222 | A fatal error has occurred. <ul style="list-style-type: none"> • A system call error has occurred. |
| 223 | The manager host encountered a logic error. |
| 224 | You have issued a request to a host other than JP1/AJS3. |
| 226 | Invalid execution environment |
| 232 | The additional execution-locked resource has the same name as an existing execution-locked resource. |
| 235 | The maximum number of execution-locked resource definitions has been exceeded. |

jpqresdel

Format

```
jpqresdel
  [-mh manager-host-name]
  -res execution-locked-resource-name
```

Description

Deletes execution-locked resources.

To execute this command, a user must have the JP1_JPQ_Admin privilege.

Execution privileges

You must have the following JP1 privilege:

- JP1_JPQ_Admin privilege

Arguments

-mh *manager-host-name*

Specify the name of a manager host from which you want to delete execution-locked resources.

You can specify a character string of 1 to 255 bytes.

By default, the system assumes the local host name.

-res *execution-locked-resource-name*

Specify the name of execution-locked resource name you want to delete.

You can specify a character string of 1 to 63 bytes.

Notes

- This command cannot be used for a request from JP1/AJS3 to JP1/OJE for VOS3.
- This command can be executed before the system executes the job using execution-locked resources to be deleted. (Note that exclusive execution lock will be ineffective during job execution.)
This command results in an error if the job using execution-locked resources to be deleted is being executed.

Return values

| | |
|---|--|
| 0 | Normal end |
| 1 | Invalid parameter value |
| 2 | An attempt to delete an execution-locked resource due to an internal cause of the host on which the <code>jpqresdel</code> command was executed. |
| 5 | Initialization has failed. <ul style="list-style-type: none">• The definition of the logical host name or the environment setting contains an error. |
| 6 | Memory became insufficient on the host on which the <code>jpqresdel</code> command was executed. |

| | |
|-----|---|
| 7 | A logical error occurred on the host on which the <code>jpqresdel</code> command was executed. |
| 100 | The host on which the <code>jpqresdel</code> command was executed cannot connect to the manager host via TCP/IP communication. <ul style="list-style-type: none"> • The host on which the <code>jpqresdel</code> command was executed cannot connect to the manager host because TCP/IP is not set up correctly. • The manager host name is invalid, or the manager host process stopped. |
| 102 | The IP address could not be resolved from the name of the manager host on which the <code>jpqresdel</code> command was executed. |
| 200 | The manager host does not accept an execution-locked resource deleting request. <ul style="list-style-type: none"> • The manager host is now being started, now being stopped, has stopped, or is running in the reduced-operation mode. |
| 201 | You cannot use a specified execution-locked resource. <ul style="list-style-type: none"> • The specified execution-locked resource is not found. |
| 202 | No response from the manager host |
| 203 | The execution-locked resource could not be deleted successfully owing to an internal cause of the manager host. |
| 206 | You do not have the privilege required to delete the execution-locked resource. |
| 219 | The manager host is busy. |
| 220 | Insufficient manager host memory. |
| 222 | A fatal error has occurred. <ul style="list-style-type: none"> • A system call error has occurred. |
| 223 | The manager host encountered a logic error. |
| 224 | You have issued a request to a host other than JP1/AJS3. |
| 226 | Invalid execution environment |
| 233 | There are jobs being executed (which are standard jobs, custom jobs, or action jobs). |

jpqresshow

Format

```
jpqresshow  
  [-mh manager-host-name]  
  {-res execution-locked-resource-name|-a|-n}
```

Description

Outputs information about execution-locked resources (the name, the status of the job using the execution-locked resources, and the job ID) to the standard output file.

Execution privileges

You must have any of the following JP1 privileges:

- JP1_JPQ_Admin privilege
- JP1_JPQ_Operator privilege
- JP1_JPQ_User privilege

Arguments

-mh *manager-host-name*

Specify the name of the manager host that contains the execution-locked resources for which information needs to be output.

You can specify a character string of 1 to 255 bytes.

By default, the system assumes the local host name.

-res *execution-locked-resource-name*

Specify the name of an execution-locked resource when you want to display its name, its status of the job using the execution-locked resource, and its job ID.

You can specify a character string of 1 to 63 bytes.

-a

Regarding all the execution-locked resources registered with the manager host specified by the **-mh** option, the system outputs their names, the status of the job using the execution-locked resources, and their job IDs.

-n

Regarding all the execution-locked resources registered with the manager host specified by the **-mh** option, the system outputs only their names.

Note

This command cannot be used for a request from JP1/AJS3 to JP1/OJE for VOS3.

Return values

| | |
|-----|---|
| 0 | Normal end |
| 1 | Invalid parameter value |
| 2 | The execution-locked resource could not be output successfully owing to an internal cause of the requester. |
| 5 | Initialization has failed. <ul style="list-style-type: none">• The definition of the logical host name or the environment setting contains an error. |
| 6 | Execution-locked resource outputting requester's insufficient memory |
| 7 | The execution-locked resource outputting requester encountered a logic error. |
| 100 | The manager host cannot be connected for TCP/IP communication. <ul style="list-style-type: none">• As TCP/IP is not validly set, the manager host cannot be connected.• The manager host name is invalid, or the manager host process stopped. |
| 102 | The IP address could not be solved successfully by the manager host name. |
| 200 | The manager host does not accept an execution-locked resource outputting request. <ul style="list-style-type: none">• The manager host is now being started, now being stopped, has stopped, or is running in the reduced-operation mode. |
| 201 | You cannot use a specified execution-locked resource. <ul style="list-style-type: none">• The specified execution-locked resource is not found. |
| 202 | No response from the manager host |
| 203 | The execution-locked resource could not be output successfully owing to an internal cause of the manager host. |
| 206 | You do not have the privilege required to output the execution-locked resource. |
| 212 | The attempt to output an execution-locked resource has failed because the execution-locked resource is being added or changed. |
| 213 | The manager host contains no execution-locked resource. |
| 219 | The manager host is busy. |
| 220 | Insufficient manager host memory |
| 222 | A fatal error has occurred. <ul style="list-style-type: none">• A system call error has occurred. |
| 223 | The manager host encountered a logic error. |
| 224 | You have issued a request to a host other than JP1/AJS3. |
| 226 | Invalid execution environment |

Output example 1

With the `-res` option specified, here is an example of file output, together with what the output means.

```
RESOURCE : Shared_File01234567890123456789012345678901234567890123456789012345678901
STATUS : EXECUTING
JOBID : 129
```

The content of the output is explained below.

RESOURCE

Specifies the execution-locked resource name.

STATUS

Shows the status of the job using execution-locked resources.

- EXECUTING: The job is currently being executed.
- WAITING: The job is not currently being executed.

JOBID

Shows the job ID of the job using execution-locked resources.

Output example 2

With the -a option specified, here is an example of file output, together with what the output means.

| RESOURCE | STATUS | JOBID |
|--|-----------|-------|
| ----- | ----- | ----- |
| Shared_File01 | WAITING | |
| Shared_File01234567890123456789012345678901234567890123... | EXECUTING | 129 |
| Network_Disk_Drive | WAITING | |

The content of the output is explained below.

RESOURCE

Specifies the execution-locked resource name. You can output up to 57 bytes. If the execution-locked resource name is 58 bytes or longer, the portion exceeding 55 bytes is indicated by "...".

STATUS

Shows the status of the job using execution-locked resources.

- EXECUTING: The job is currently being executed.
- WAITING: The job is not currently being executed.

JOBID

Shows the job ID of the job using execution-locked resources.

Output example 3

With the -n option specified, here is an example of file output, together with what the output means.

```
RESOURCE
-----
Shared_File01
Shared_File0123456789012345678901234567890123456789012345678901
Network_Disk_Drive
```

The content of the output is explained below.

RESOURCE
Specifies the execution-locked resource name.

5

Creating Information Definition Files

This chapter describes how to create definition files.

5.1 Creating a unit definition file

A unit definition file is used to define the configuration and details of units. To use the `ajsdefine` command to define units, specify one or more unit definition files.

This section explains how to create a unit definition file.

5.1.1 Format of unit definition files

The following shows how to specify unit definition parameters in a unit definition file.

Figure 5–1: Format of unit definition files

```
/* comment */ ..... (A)
unit-attribute-parameter ..... (B)
{ ..... (C)
    unit-definition-parameters ..... (D)
    lower-level-unit-attribute-parameter ..... (E)
    {
        lower-level-unit-nesting-definition
        lower-level-unit-nesting-definition
        lower-level-unit-nesting-definition
    }
    lower-level-unit-attribute-parameter
    lower-level-unit-attribute-parameter
    lower-level-unit-attribute-parameter
} ..... (F)

unit-attribute-parameter
unit-attribute-parameter
unit-attribute-parameter
```

The following explains the items in a unit definition file.

(A) *comment*

To make a comment, enclose it within `/*` and `*/`.

You cannot write a comment in a line where you have defined a unit attribute parameter or a unit definition parameter.

You cannot nest a comment as in `/*/*xxxx*/*/`.

(B) *unit-attribute-parameter*

This item defines a unit attribute.

The following gives the format of this item.

```
unit=unit-name [, [permission-mode] [, [JP1-user-name] [, [JP1-resource-group-name] ] ] ] ;
```

The following explains each parameter.

- *unit-name*

Specify a unit name.

You can specify a character string of 1 to 30 bytes. Note that if the character encoding is UTF-8 and `sjis` is specified for the `DEFLENTYPE` environment setting parameter, you can specify from 1 to 30 bytes after conversion to Shift-JIS.

For a unit name, you cannot specify a root job group (/).

- *permission-mode*

Specify the permission mode for a unit.

You can specify any four-digit octal values. The following gives the meaning of each digit. If each item of definition information contains an `eu` parameter, the value specified in the parameter is valid.

First digit

Specify the user who executes the job.

0 to 3: The JP1 user who registered the jobnet executes the job.

4 to 7: The JP1 user who owns the job executes the job.

Second to fourth digits

Specify any string.

- *JP1-user-name*

Specify the name of the JP1 user who owns the unit.

You can specify a character string of 1 to 30 bytes. The default is the JP1 user name of the user who created the unit.

An event receiving job is ignored if specified.

- *JP1-resource-group-name*

Specify a JP1 resource group name.

You can specify a character string of 1 to 63 bytes. The string can consist of alphanumeric characters and an underscore (_). By default, no characters are assumed.

An event receiving job is ignored if specified.

(C) {

Indicates the start of a unit definition parameter.

The contents enclosed by { and } provide the unit definition parameters for the unit specified in the unit attribute parameter.

(D) *unit-definition-parameters*

Specify unit definition parameters.

For details, see [5.2 Definition format and parameters](#).

(E) *lower-level-unit-attribute-parameter*

Specify a lower-level unit attribute parameter.

Be sure to specify a lower-level unit attribute parameter at the end of the unit definition parameters for the upper-level unit.

For details, see [\(B\) unit-attribute-parameter](#).

(F) }

Indicates the end of a unit definition parameter.

5.1.2 Notes on defining unit definition parameters

The information to be defined in the file differs depending on what type of unit you want to define.

This subsection first explains which definitions are required to determine a unit. Then, this subsection explains how to specify each definition.

The unit you want to define is related to the required definition as summarized in *Table 5-1*. Note that definitions 1-8 in *Table 5-1* refer to the following:

Definition 1

Attribute definition

Definition 2

Unit configuration definition

Definition 3

Job group definition

Definition 4

Jobnet definition

Definition 5

Job definition

The following jobs are covered:

- UNIX/PC job
- QUEUE job
- Judgment job
- JP1 event reception monitoring job
- File monitoring job
- Email reception monitoring job
- Message-queue message reception monitoring job
- MSMQ message reception monitoring job
- Log file monitoring job
- Windows event-log monitoring job
- Execution-interval control job
- JP1 event sending job
- Email sending job
- Message-queue message sending job
- MSMQ message sending job
- OpenView Status Report job
- Local power control job
- Remote power control job
- UNIX/PC custom job
- Passing information setting job
- Flexible job
- HTTP Connection job
- Custom event job

Definition 6

Manager unit definition

The manager unit is a combination of a manager job group and a manager jobnet.

Definition 7

Start condition definition

Definition 8

Jobnet connector definition

Table 5–1: Required definitions

| | Definition 1 | Definition 2 | Definition 3 | Definition 4 | Definition 5 | Definition 6 | Definition 7 | Definition 8 |
|----------------------------|--------------|--------------|-------------------|-------------------|--------------|--------------|--------------|--------------|
| Job group | Yes | Yes | Yes ^{#3} | -- | -- | -- | -- | -- |
| Jobnet | Yes | Yes | -- | Yes ^{#3} | -- | -- | -- | -- |
| Job ^{#1} | Yes | -- | -- | -- | Yes | -- | -- | -- |
| Manager unit ^{#2} | Yes | -- | -- | -- | -- | Yes | -- | -- |
| Start condition | Yes | -- | -- | -- | -- | -- | Yes | -- |
| Jobnet connector | Yes | -- | -- | -- | -- | -- | -- | Yes |

Legend:

Yes: Necessary

--: Unnecessary

#1

For the types of jobs, see the explanation of *Definition 5* above.

#2

For the types of manager units, see the explanation of *Definition 6* above.

#3

To use a jobnet connector to control the execution order of a root jobnet or a root jobnet that is immediately under a planning group, you must specify the execution order control method for jobnet connectors.

For an explanation of how to specify each definition, see *5.2 Definition format and parameters*.

5.2 Definition format and parameters

This section describes the format of definition for defining units.

5.2.1 Attribute definition

This paragraph explains how to specify an attribute definition.

Specify an attribute definition at the beginning of each unit definition parameter.

The following shows the format of, and parameters for an attribute definition.

Format

```
ty={g|mg|n|rn|rm|rr|rc|mn|j|rj|pj|
    rp|qj|rq|j dj|rj dj|orj|rorj|evwj|
    revwj|flwj|rflwj|mlwj|rmlwj|mqwj|
    rmqwj|mswj|rmswj|lfwj|rlfwj|ntwj|
    rntwj|tmwj|rtmwj|evsj|revsj|mlsj|
    rmlsj|mqsj|rmqsj|mssj|rmssj|cmsj|
    rcmsj|pwlj|rpwlj|pwrj|rpwrj|cj|rcj|
    cpj|rcpj|fxj|rfxj|htpj|rhtpj|nc|
    cewj|rcewj};
[cm="comment";]
```

Parameters

ty=

Specify a unit type.

- g: Defines a job group or Planning group
- mg: Defines a manager job group.
- n: Defines a jobnet.
- rn: Defines a jobnet for recovery.
- rm: Defines a remote jobnet.
- rr: Defines a jobnet for recovery.
- rc: Defines start conditions for a root jobnet.
- mn: Defines a manager jobnet.
- j: Defines a Unix job.
- rj: Defines a Unix job for recovery.
- pj: Defines a PC job.
- rp: Defines a PC job for recovery.
- qj: Defines a QUEUE job.
- rq: Defines a QUEUE job for recovery.
- j dj: Defines a judgment job.
- rj dj: Defines a judgment job for recovery.

- `orj`: Defines an OR job.
- `rorj`: Defines an OR job for recovery.
- `evwj`: Defines a JP1 event reception monitoring job.
- `revwj`: Defines a JP1 event reception monitoring job for recovery.
- `flwj`: Defines a file monitoring job.
- `rflwj`: Defines a file monitoring job for recovery.
- `mlwj`: Defines an email reception monitoring job.
- `rmlwj`: Defines an email reception monitoring job for recovery.
- `mqwj`: Defines a message queue reception monitoring job.
- `rmqwj`: Defines a message queue reception monitoring job for recovery.
- `mswj`: Defines an MSMQ reception monitoring job.
- `rmswj`: Defines an MSMQ reception monitoring job for recovery.
- `lfwj`: Defines a log file monitoring job.
- `rlfwj`: Defines a log file monitoring job for recovery.
- `ntwj`: Defines a Windows event-log monitoring job.
- `rntwj`: Defines a Windows event-log monitoring job for recovery.
- `tmwj`: Defines an execution-interval control job.
- `rtmwj`: Defines an execution-interval control job for recovery.
- `evsj`: Defines a JP1 event sending job.
- `revsj`: Defines a JP1 event sending job for recovery.
- `mlsj`: Defines an email sending job.
- `rmlsj`: Defines an email sending job for recovery.
- `mqsj`: Defines a message queue sending job.
- `rmqsj`: Defines a message queue sending job for recovery.
- `mssj`: Defines an MSMQ sending job.
- `rmssj`: Defines an MSMQ sending job for recovery.
- `cmsj`: Defines an OpenView Status Report job.
- `rcmsj`: Defines an OpenView Status Report job for recovery.
- `pwlj`: Defines a local power control job.
- `rpwlj`: Defines a local power control job for recovery.
- `pwrj`: Defines a remote power control job.
- `rpwrj`: Defines a remote power control job for recovery.
- `cj`: Defines a custom Unix job.
- `rcj`: Defines a custom Unix job for recovery.
- `cpj`: Defines a custom PC job.
- `rcpj`: Defines a custom PC job for recovery.

- `fxj`: Defines a flexible job
- `rfxj`: Defines a flexible job for recovery
- `htpj`: Defines an HTTP Connection job
- `rhtpj`: Defines an HTTP Connection job for recovery
- `nc`: Defines a jobnet connector.
- `cewj`: Defines a custom event job.
- `rcewj`: Defines a custom event job for recovery.

`cm="comment" ;`

Write a comment.

You can use a character string of 1 to 80 bytes. Note that if the character encoding is UTF-8 and `sjis` is specified for the `DEFLENTYPE` environment setting parameter, you can specify from 1 to 80 bytes after conversion to Shift-JIS.

If you want to use a double quotation mark (") or a hash mark (#) as a character, prefix the character by #. That is, use `#"` instead of `"` and use `##` instead of `#`.

5.2.2 Unit configuration definition

This paragraph explains how to specify a unit configuration definition.

The following gives the format of, and parameters for a unit configuration definition.

Format

```
[el=unit-name, unit-type, +H +V;]
[sz=lateral-icon-count-times-longitudinal-icon-count;]
```

Parameters

`el=unit-name, unit-type, +H +V;`

Specify the information for a unit.

- `unit-name`: Specify a unit name.
You can specify a character string of 1 to 30 bytes.
- `unit-type`: Specify a unit type.
For details about the unit type, see the `ty` parameter in [5.2.1 Attribute definition](#).

`+H`

To display the icon of a unit in the JP1/AJS3 - View window, specify in pixels the horizontal location of the unit icon.

You can set 0 to 16,000 (pixels).

Use the formula below to determine the pixel value.

$$H = 80 + 160x \quad (x: 0 \text{ to lateral icon count} - 1)$$

If you set a value other than that determined from the formula, the system automatically sets a suitable value.

For a job group and a unit covered in the start conditions, `H` defaults to 0.

`+V`

To display a unit in the JP1/AJS3 - View window, specify in pixels the vertical location of the unit icon.

You can set 0 to 10,000 (pixels).

Use the formula below to determine the pixel value.

$$V = 48 + 96y \text{ (} y: 0 \text{ to longitudinal icon count} - 1 \text{)}$$

If you set a value other than that determined from the formula, the system automatically sets a suitable value.

For a job group and a unit covered in the start conditions, V defaults to 0.

$s_z = \text{lateral-icon-count} \times \text{longitudinal-icon-count}$;

Define the maximum number of unit icons displayed in the JP1/AJS3 - View window. This is valid only for a jobnet and a remote jobnet.

- *lateral-icon-count*: You can set 1 to 100. The default is 10.
- *longitudinal-icon-count*: You can set 1 to 100. The default is 8.

5.2.3 Job group definition

This subsection describes how to define a job group (or planning group).

The following gives the format of and parameters for a job group definition.

Format

```
[op={yyyy/mm/dd|{su|mo|tu|we|th|fr|sa}}];  
[cl={yyyy/mm/dd|{su|mo|tu|we|th|fr|sa}}];  
[sdd={dd|{su|mo|tu|we|th|fr|sa}:n}];  
[md={th|ne}];  
[stt=hh:mm];  
[gty={p|n}];  
[ncl={y|n}];  
[ncn=jobnet-connector-name];  
[ncs={y|n}];  
[ncex={y|n}];  
[nchn="connection-host-name"];  
[ncsv=connection-service-name];
```

Parameters

$op = \{yyyy/mm/dd | \{su|mo|tu|we|th|fr|sa\}\};$

Define an open day as calendar information.

- *yyyy*: Specify the calendar year containing an open day. You can set a value between 1994 and the value of the SCHEDULELIMIT environment setting parameter. For details about the SCHEDULELIMIT environment setting parameter, see 20.4.2(123) SCHEDULELIMIT in the JP1/Automatic Job Management System 3 Configuration Guide.
- *mm*: Specify the month containing an open day. You can set 1 to 12.
- *dd*: Specify an open day. You can set 1 to 31.
- *su*: Sets Sunday as an open day.
- *mo*: Sets Monday as an open day.
- *tu*: Sets Tuesday as an open day.
- *we*: Sets Wednesday as an open day.
- *th*: Sets Thursday as an open day.
- *fr*: Sets Friday as an open day.

- `sa`: Sets Saturday as an open day.

```
cl={yyyymm/dd|{su|mo|tu|we|th|fr|sa}};
```

Define a closed day as calendar information.

- `yyy`: Specify the calendar year containing a closed day. You can set a value between 1994 and the value of the `SCHEDULELIMIT` environment setting parameter. For details about the `SCHEDULELIMIT` environment setting parameter, see *20.4.2(123) SCHEDULELIMIT* in the *JP1/Automatic Job Management System 3 Configuration Guide*.
- `mm`: Specify the month containing a closed day. You can set 1 to 12.
- `dd`: Specify a closed day. You can set 1 to 31.
- `su`: Sets Sunday as a closed day.
- `mo`: Sets Monday as a closed day.
- `tu`: Sets Tuesday as a closed day.
- `we`: Sets Wednesday as a closed day.
- `th`: Sets Thursday as a closed day.
- `fr`: Sets Friday as a closed day.
- `sa`: Sets Saturday as a closed day.

```
sdd={dd|{su|mo|tu|we|th|fr|sa}:n};
```

Define the base date as calendar information.

The default is the base date for an upper-level job group. If no base date is defined for any upper-level job group, 1 is assumed.

- `dd`: Specify the base date as a calendar day. You can set 1 to 31.
- `su`: Sets Sunday as the base date.
- `mo`: Sets Monday as the base date.
- `tu`: Sets Tuesday as the base date.
- `we`: Sets Wednesday as the base date.
- `th`: Sets Thursday as the base date.
- `fr`: Sets Friday as the base date.
- `sa`: Sets Saturday as the base date.
- `n`: Define the week of the month and the day of the week as the base date. You can set 1 to 5 (first week to fifth week).

```
md={th|ne};
```

Define the base month as calendar information. The default is the base month for an upper-level job group. If no base month is defined for any upper-level job group, `th` is assumed.

- `th`: Considers the days following the base date as belonging to the month containing the base date (current month).
- `ne`: Considers the days following the base date as belonging to the next month.

```
stt=hh:mm;
```

Define the base time as calendar information. The default is the base time for an upper-level job group. If no base time is defined for any upper-level job group, 00:00 is assumed.

- `hh`: Specify hours of the base time. You can set 0 to 23.

- *mm*: Specify minutes of the base time. You can set 0 to 59.

`gty={p|n}`

Specifies the type of the job group. The default is *n*.

- *p*: Planning group
- *n*: Job group

`ncl={y|n};`

If the job group is a planning group, define whether to use a jobnet connector to control the execution order of a root jobnet that is immediately under a planning group. If you omit this option, the system assumes *n*. You can specify this option only when the planning group is specified as the type of job group (`gty=p`).

- *y*: The execution order of a root jobnet that is immediately under a planning group is controlled.
- *n*: The execution order of a root jobnet that is immediately under a planning group is not controlled.

`ncn=jobnet-connector-name;`

If the execution order of a root jobnet that is immediately under a planning group is to be controlled, specify the unit full name of the jobnet connector to be connected. You can specify a character string of 1 to 930 bytes. If you specify any of the following unit names, an error occurs:

- A unit name that does not begin with a slant (/)
- A unit name in which a character string between slants (/) exceeds 30 bytes
- A unit name that ends with a slant (/)

You can specify this option only when the planning group is specified as the type of job group (`gty=p`). If you specify this option when *y* has not been specified for the `ncl` parameter, an error occurs.

`ncs={y|n};`

If the execution order of a root jobnet that is immediately under a planning group is to be controlled, define the execution order control method. If you omit this option, the system assumes *n*. You can specify this option only when the planning group is specified as the type of job group (`gty=p`). If you specify this option when *y* has not been specified for the `ncl` parameter, an error occurs.

- *y*: The root jobnet is executed synchronously with the jobnet connector.
- *n*: The root jobnet is executed asynchronously with the jobnet connector.

`ncex={y|n};`

If the execution order of a root jobnet that is under a planning group is to be controlled, define whether to enable linkage between scheduler services. If you omit this option, the system assumes *n*.

You can specify this option only when the planning group is specified as the type of job group.

If you specify this option when *y* has not been specified for the `ncl` parameter, an error occurs.

- *y*: Linkage between scheduler services is enabled.
Linkage with jobnet connectors defined on other hosts or in other scheduler services is possible.
- *n*: Linkage between scheduler services is disabled.
Linkage with jobnet connectors defined in only the same scheduler service is possible.

`nchn="connection-host-name";`

Specify the name of the host on which the jobnet connector to be connected has been defined. You can specify a character string of 1 to 255 bytes. You cannot specify spaces, tab characters, or linefeed characters.

You can specify this option only when the planning group is specified as the type of job group. If you specify this option when *y* has not been specified for the `ncex` parameter, an error occurs.

If you want to use a double quotation mark (") or a hash mark (#) as a character, prefix the character by #. That is, use #" instead of " and use ## instead of #.

`nCSV=connection-service-name;`

Specify the name of the scheduler service in which the jobnet connector to be connected has been defined. You can specify a character string of 1 to 30 bytes.

You can specify this option only when the planning group is specified as the type of job group. If you specify this option when `y` has not been specified for the `ncex` parameter, an error occurs.

5.2.4 Jobnet definition

This paragraph explains how to specify a jobnet definition.

To concurrently define multiple unit, specify the upper-level unit definition parameters and then the parameters of a lower-level unit.

The following gives the format of, and parameters for a jobnet definition.

Format

```
[sd=[N, ] { [ [yyyy/] mm/ ] { [+|*|@] dd
  | [+|*|@] b[-DD] | [+ ] {su|mo|tu|we|th|fr|sa}
  [ : {n|b} ] } |en|ud}; ]
[st=[N, ] [+ ] hh:mm; ]
[sy=[N, ] hh:mm {M|U|C} mmmm; ]
[ey=[N, ] hh:mm {M|U|C} mmmm; ]
[ln=[N, ] n; ]
[cy=[N, ] (n, {y|m|w|d}); ]
[sh=[N, ] {be|af|ca|no}; ]
[shd=[N, ] n; ]
[wt=[N, ] {no|hh:mm|mmmm|un}; ]
[wc=[N, ] {no|n|un}; ]
[cftd=[N, ] {no|be|af|db|da} [, n[, N]]; ]
[ed=yyyy/mm/dd; ]
[rg=n; ]
[pr=n; ]
[ni=n; ]
[ha={y|w|a|n}; ]
[ejn=exclusive-jobnet-name; ]
[cd={no|un|n}; ]
[de={y|n}; ]
[ms={sch|mlt}; ]
[mp={y|n}; ]
[jc=full-path-job-group-name; ]
[rh="execution-manager-name"; ]
[ex="execution-agent-name"; ]
[fd=time-required-for-execution; ]
[ar=(f=preceding-unit-name, t=succeeding-unit-name[, relation-type]); ]
[ncl={y|n}; ]
[ncn=jobnet-connector-name; ]
[ncs={y|n}; ]
[ncex={y|n}; ]
[nchn="connection-host-name"; ]
[nCSV=connection-service-name; ]
[mm={and|or}; ]
```

```
[nmg={y|n};]
[eun=name-of-the-unit-whose-end-is-being-waited-for;]
[ega={exec|execdefer|none};]
[uem={y|n};]
```

Parameters

```
sd=[N, ] { [ [yyyy/]mm/ ] { [+|*|@]dd| [+|*|@]b[-DD] | [+ ] {su|mo|tu|we|th|fr|sa} [ : {n|b} ] } |en|ud};
```

Define the dates when the jobnet is to be executed. You can define up to 144 execution start dates. If you omit this parameter in the root jobnet, the system assumes "1, en".

- *N*: When defining multiple jobnet execution start dates, specify a rule number. You can set 0 to 144. This number corresponds to the rule numbers for the execution start time, start delay time, end delay time and appropriate upper-level jobnet, and the rule numbers for the processing cycle, shift method and maximum shift days.
If you specify `sd=0, ud`, you can make all the items undefined.
- *yyyy*: Specify the calendar year containing the date when the jobnet is executed. You can set a value between 1994 and the value of the `SCHEDULELIMIT` environment setting parameter. For details about the `SCHEDULELIMIT` environment setting parameter, see *20.4.2(123) SCHEDULELIMIT* in the *JP1/Automatic Job Management System 3 Configuration Guide*.
The default is the year containing the date when the jobnet was registered for execution.
- *mm*: Specify the month when the jobnet is executed. You can set 1 to 12. The default is the month containing the day when the jobnet was registered for execution.
- *+*: Sets the date when the jobnet is executed on the basis of a relative day.
- ***: Sets the date when the jobnet is executed on the basis of an open day.
- *@*: Sets the date when the jobnet is executed on the basis of a closed day.
- *dd*: Define the day when the jobnet is executed.
When specifying an absolute date
Year/month/day: specification 1 to last day of specified year/month.
Month/day specification: 1 to last day of specified month. For February, however, 1 to 29.
Day specification: 1 to 31.
When specifying a relative date or the number of open or closed days
1 to 35 (days).
- *b*: Sets the date when the jobnet is executed as the end day of the month.
- *-DD*: Specify how many days precede the end of the month or the last open day to set the date when the jobnet is executed. The default is the end of the month or the last open day.
When specifying an absolute date
Year/month/day specification: 0 to (last day of specified year/month -1).
Month/day specification: 0 to (last day of specified month -1). For February, however, 0 to 28.
Day specification: 0 to 30.
When specifying a relative date or the number of open or closed days
0 to 34 (days).
- *su*: Sets Sunday as the date when the jobnet is executed.
- *mo*: Sets Monday as the date when the jobnet is executed.
- *tu*: Sets Tuesday as the date when the jobnet is executed.

- `we`: Sets Wednesday as the date when the jobnet is executed.
- `th`: Sets Thursday as the date when the jobnet is executed.
- `fr`: Sets Friday as the date when the jobnet is executed.
- `sa`: Sets Saturday as the date when the jobnet is executed.
- `n`: Specify what week from the beginning of the month contains the specified day of the week. You can set 1 to 5 (first week to fifth week). The default is 1 if you have specified a year (`yyyy`) and month (`mm`), and the week containing a specified day of the week nearest the date of registration for execution.
- `en`: Sets the date when the jobnet is registered for execution as the date when it is executed.
- `ud`: Makes all the schedules for the jobnet undefined. Be sure to set `N` to 0.

`st=[N,] [+] hh : mm ;`

Define the time when the jobnet is executed. The default is `+00 : 00` (0 hours 00 minutes as the relative time).

- `N`: Specify the rule number of the execution start time corresponding to the rule number of the jobnet execution start date. You can set 1 to 144. The default is 1.
- `+`: Specify that the `hh : mm` time when the jobnet is executed is the relative time. The default specifies the absolute time.
- `hh`: Specify the hours of the time when the jobnet is executed. You can set 0 to 47. The default is 0.
- `mm`: Specify the minutes of the time when the jobnet is executed. You can set 0 to 59 as the minutes value. The default is 0.

`sy=[N,] hh : mm | {M|U|C} mmmm ;`

Define the delayed start time for a jobnet.

- `N`: Specify the rule number of delayed start time corresponding to the date when the jobnet is executed. You can set 1 to 144. The default is 1.
- `hh`: Specify the hours of the delayed start time for a jobnet. You can set 0 to 47.
- `mm`: Specify the minutes of the delayed start time for a jobnet. You can set 0 to 59.
- `M`: Sets the minutes specified in `mmmm` as the relative minutes from the time when the root jobnet is executed.
- `U`: Sets the minutes specified in `mmmm` as the relative minutes from the time when the upper-level jobnet is executed.
- `C`: Sets minutes the specified in `mmmm` as the relative minutes from the time when the jobnet is executed.
- `mmmm`: Specify the delayed start time as the relative minutes from the time when the root jobnet, upper-level jobnet or the jobnet itself is executed. You can set 1 to 2,879.

`ey=[N,] hh : mm | {M|U|C} mmmm ;`

Define the delayed end time for a jobnet.

- `N`: Specify the rule number of delayed end time corresponding to the date when the jobnet is executed. You can set 1 to 144. The default is 1.
- `hh`: Specify the hours of the delayed end time for a jobnet. You can set 0 to 47.
- `mm`: Specify the minutes of the delayed end time for a jobnet. You can set 0 to 59.
- `M`: Sets the minutes specified in `mmmm` as the relative minutes from the time when the root jobnet is executed.
- `U`: Sets the minutes specified in `mmmm` as the relative minutes from the time when the upper-level jobnet is executed.
- `C`: Sets minutes the specified in `mmmm` as the relative minutes from the time when the jobnet is executed.

- *mmmm*: Specify the delayed end time as the relative minutes from the time when the root jobnet, upper-level jobnet or the jobnet itself is executed. You can set 1 to 2,879.

`ln=[N,]n;`

Define the rule number of the schedule for the upper-level jobnet. Note that any attempt to specify the root jobnet will be ignored.

- *N*: Specify the rule number of the date when the jobnet is executed. You can set 1 to 144. The default is 1.
- *n*: Specify the rule number of the date when the upper-level jobnet is executed. You can set 1 to 144.

`cy=[N,](n, {y|m|w|d});`

Define a processing cycle for a jobnet. By default, no processing cycle is set.

- *N*: Specify the rule number of the date when the jobnet is executed. You can set 1 to 144. The default is 1.
- *n*: Specify the number of processing cycles. The value you can set depends on the parameter (*y*, *m*, *w*, or *d*) you specify.
- *y*: Sets the unit for the processing cycle as a year. For *n*, you can set 1 to 9 (years).
- *m*: Sets the unit for the processing cycle as a month. For *n*, you can set 1 to 12 (months).
- *w*: Sets the unit for the processing cycle as a week. For *n*, you can set 1 to 5 (weeks). If you have defined the execution start date by an open or closed day (*sd=* or sd=@*), you cannot specify this parameter. If you specify this parameter, the schedule is calculated assuming that one week is equal to seven open days or seven closed days; however, we recommend that you specify the processing cycle on a daily basis. A good example would be *7, d*, instead of *1, w*.
- *d*: Sets the unit for the processing cycle as a day. For *n*, you can set 1 to 31 (days).

`sh=[N,]{be|af|ca|no};`

If the jobnet is scheduled to be executed on a closed day on the JP1/AJS3 calendar, define how to substitute the schedule of the closed day job.

- *N*: Specify the rule number of the date when the jobnet is executed. You can set 1 to 144. The default is 1.
- *be*: Applies the previous day of the execution schedule day if it is closed.
- *af*: Applies the next day of the execution schedule day if it is closed.
- *ca*: Does not execute the jobnet if the execution schedule day is closed.
- *no*: Forcibly executes the jobnet on the closed day set as the execution schedule day only if the JP1/AJS3 service is started.

`shd=[N,]n;`

Define the maximum number of shift days for jobnet execution.

- *N*: Specify the rule number of the date when the jobnet is executed. You can set 1 to 144. The default is 1.
- *n*: Specify the maximum number of shift days for jobnet execution. You can set 1 to 31 (days). The default is 2.

`wt=[N,]{no|hh:mm|mmmm|un};`

Define the monitoring end time of the start condition. The default is *no*. Specify this parameter together with the *wc* parameter.

- *N*: Specify the rule number of the date when the jobnet is executed. You can set 1 to 144. The default is 1.
- *no*: Does not use a start condition. If this value is specified, the number of executions of the execution generation until the end of monitoring of the start condition in the *wc* parameter is invalid even if the number of executions is defined.
- *hh*: Specify the hour of the monitoring end time of the start condition. You can set 0 to 47.

- *mm*: Specify the minute of the monitoring end time of the start condition. You can set 0 to 59.
- *mmmm*: Specify the time of the monitoring end time of the start condition by the relative minutes from the time when the start condition monitoring is executed. You can set 1 to 2,879 (minutes).
- *un*: Specify no limit for the monitoring end time of the start condition.

`wc=[N,] {no|n|un};`

Define the number of executions of the execution generation from when the monitoring of the start condition starts until the monitoring of the start condition ends. The default is *no*. Specify this parameter together with the *wt* parameter.

- *N*: Specify the rule number of the date when the jobnet is executed. You can set 1 to 144. The default is 1.
- *no*: Does not use a start condition. If this value is specified, the monitoring end time of the start condition in the *wt* parameter is invalid even if the monitoring end time is defined.
- *n*: Specify the number of executions of the execution generation until monitoring of the start condition ends. You can set 1 to 999. The default is 1.
- *un*: Specify no limit for the number of executions of the execution generation until monitoring of the start condition ends.

`cftd=[N,] {no|be|af|db|da} [, n [, N]];`

Define the schedule of the jobnet according to the days from the start time. The default is *no*.

- *N*: Specify the rule number of the date when the jobnet is executed. You can set 1 to 144. The default is 1.
- *no*: Does not use a schedule according to the days from the start time.
- *be*: Replaces the date of jobnet execution by an open day preceding the start date (the execution schedule date fixed by specifying a processing cycle or setting substitution).
- *af*: Replaces the date of jobnet execution by an open day following the start date (the execution schedule date fixed by specifying a processing cycle or setting substitution).
- *db*: Replaces the date of jobnet execution by the day preceding the start date (the execution schedule date fixed by specifying a processing cycle or setting substitution). Because closed days are not skipped, the jobnet might be executed on a closed day.
- *da*: Replaces the date of jobnet execution by the day following the start date (the execution schedule date fixed by specifying a processing cycle or setting substitution). Because closed days are not skipped, the jobnet might be executed on a closed day.
- *n*: Specify the number of start days. You can set 1 to 31 (days). The default is 1. If you specify *cftd=no*, this item is invalid.
- *N*: Specify the maximum number of shift days. You can set 1 to 31 (days). The default is 10. If you specify *cftd=no*, *cftd=db*, or *cftd=da*, this item is invalid.

`ed=yyyy/mm/dd;`

Define the expiration date of a defined schedule. By default, the system does not check the expiration date.

- *yyyy*: Specify the calendar year of the expiration date. You can set a value between 1994 and the value of the `SCHEDULELIMIT` environment setting parameter. For details about the `SCHEDULELIMIT` environment setting parameter, see 20.4.2(123) `SCHEDULELIMIT` in the *JP1/Automatic Job Management System 3 Configuration Guide*.
- *mm*: Specify the month of the expiration date. You can set 1 to 12.
- *dd*: Specify the day of the expiration date. You can set 1 to 31.

`rg=n;`

Define saved generations of the jobnet. You can, however, enable the system setting option to increase the number of generations to up to 999. The default is 1. You can specify this parameter only for the root jobnet. For a nested jobnet, the system inherits a value defined for the root jobnet.

`pr=n;`

Define the default for the priority of jobnet job execution. You can set 1 to 5. The lowest priority of execution is 1, while the highest priority is 5. The default value depends on the definition of upper-level jobnets.

The value specified in this parameter is used if the `pr` parameter is not specified for the jobs in the jobnet. The system assumes a value of 1 as the priority in job execution if this parameter is not specified for any of the upper-level jobnets (including the highest level) and if the `ni` parameter is not specified.

If this and the `ni` parameter are specified together, the value of the second parameter will be valid.

`ni=n;`

Define the default for the priority of jobnet job execution. You can set -39 to 39. The specified value is replaced by the default for the priority of job execution in the `pr` parameter. The relationship is summarized below.

| ni parameter settings | Default for the priority of job execution |
|-----------------------|---|
| 11 to 39 | 5 |
| 1 to 10 | 4 |
| 0 | 3 |
| -10 to -1 | 2 |
| -39 to -11 | 1 |

The default value depends on the definition of upper-level jobnets.

The value specified in this parameter is used if the `pr` parameter is not specified for the jobs in the jobnet. The system assumes a value of 1 as the priority of job execution if this parameter is not specified for any of the upper-level jobnets (including the highest level) and if the `pr` parameter is not specified.

If this parameter is specified together with the `pr` parameter, the value of the parameter specified later will be effective.

`ha={y|w|a|n};`

Define whether to suspend jobnet execution. The default is `n`. If you specify `w` or `a` for a nested jobnet, the system assumes `n`.

- `y`: Suspends jobnet execution.
- `w`: Suspends jobnet execution only if the last jobnet end status is Ended with warning, Ended abnormally, Skipped so not exe., Invalid exe. seq., Interrupted, or Killed. You cannot specify this parameter with `mp=y`.
- `a`: Suspends jobnet execution only if the last jobnet end status is Ended abnormally, Skipped so not exe., Invalid exe. seq., Interrupted, or Killed.
- `n`: Does not suspend jobnet execution.

`ejn=exclusive-jobnet-name;`

Define the name of a jobnet you do not want to execute while executing this jobnet (a jobnet in the same level). You can set a character string of 1 to 30 bytes. Note that if the character encoding is UTF-8 and `sjis` is specified for the `DEFLENTYPE` environment setting parameter, you can specify from 1 to 30 bytes after conversion to Shift-JIS.

`cd={no|un|n};`

Define the number of days after which the waiting is canceled for the jobnet in the Being held, Wait for start cond or Waiting for the start time status.

The default is `no`.

- `no`: The value set in the system option is applied as the timeout of the wait status.
- `un`: Waits without setting a timeout.
- `n`: Specify the number of days the jobnet waits. Specify the relative number of days from the base date for the job group to which the jobnet belongs. You can set 1 to 2 (days).

`de={y|n};`

Define dependence on the schedule for the upper-level jobnet. The default is `y`. You cannot define this parameter for the root jobnet.

- `y`: The jobnet depends on the schedule for the upper-level jobnet. You cannot specify this parameter together with the `sd` parameter.
- `n`: The jobnet does not depend on the schedule for the upper-level jobnet.

`ms={sch|mlt};`

Define a schedule option for jobnet execution. The default is `sch`.

- `sch`: Uses a schedule skip option.
- `mlt`: Uses a multi-schedule option.

`mp={y|n};`

Define whether to enable concurrent jobnet execution. The default is `n`.

- `y`: Enables concurrent execution. You cannot specify this together with `ha=w` or `ha=a`.
- `n`: Disables concurrent execution.

`jc=job-group-full-name;`

Define the job group name that contains the definition of the calendar information specified on a jobnet basis. You can set a character string of 1 to 930 bytes.

`rh="execution-manager-name";`

Define the name of the JP1/AJS3 - Manager host in which a remote jobnet will be executed.

You can set a character string of 1 to 255 bytes. If you omit this option, a message KAVS0289-E is output as the execution result of the remote jobnet, and an error occurs.

If you want to use a double quotation mark (") or a hash mark (#) as a character, prefix the character by #. That is, use # " instead of " and use ## instead of #.

`ex="execution-agent-name";`

Define the name of the execution agent or execution agent group that is used to execute jobs.

You can set a character string of 1 to 255 bytes.

If you want to use a double quotation mark (") or a hash mark (#) as a character, prefix the character with #. That is, use # " instead of ", and use ## instead of #.

You can specify a macro variable.

If job definition information contains no specified agent name to execute, the system uses the name set here. If this parameter is not specified, the following value is assumed:

- The local host name is assumed for the root jobnet.
- The value of the upper-level jobnet is assumed for a nested jobnet.

- The value specified for the execution manager is assumed for a remote jobnet.

`fd=time-required-for-execution;`

Define the time required for executing the jobnet or remote jobnet for which the termination delay is monitored.

You can specify a decimal value between 1 and 2,879 (minutes).

`ar=(f=preceding-unit-name, t=succeeding-unit-name[, relation-type]);`

Define the order in which units are executed. (This definition is equivalent to defining execution order by relating icons in the map area in the Jobnet Edit window for JP1/AJS3 - View.)

- `f=preceding-unit-name`: Specify the name of a unit or judgment job to be executed earlier. You can set a character string of 1 to 30 bytes.
- `t=succeeding-unit-name`: Specify the name of a unit to be executed subsequently or dependent unit. You can set a character string of 1 to 30 bytes.
- `relation-type`: Define the method of establishing a relationship. The default is `seq`.
`seq`: Sequential relationship
`con`: Provides a conditional connection with the judgment job as a dependent unit. This can be specified only when the preceding unit name contains a judgment job.

`ncl={y|n};`

For a root jobnet, define whether to use a jobnet connector to control the execution order. If you omit this option, the system assumes `n`.

You can specify this option only for a root jobnet.

- `y`: The execution order of the root jobnet is controlled.
- `n`: The execution order of the root jobnet is not controlled.

`ncn=jobnet-connector-name;`

If the execution order of a root jobnet is to be controlled, specify the unit full name of the jobnet connector to be connected. You can specify a character string of 1 to 930 bytes. If you specify any of the following unit names, an error occurs:

- A unit name that does not begin with a slant (/)
- A unit name in which a character string between slants (/) exceeds 30 bytes
- A unit name that ends with a slant (/)

You can specify this option only for a root jobnet. If you specify this option when `y` has not been specified for the `ncl` parameter, an error occurs.

`nsc={y|n};`

If the execution order of a root jobnet is to be controlled, define the execution order control method. If you omit this option, the system assumes `n`. You can specify this option only for a root jobnet. If you specify this option when `y` has not been specified for the `ncl` parameter, an error occurs.

- `y`: The root jobnet is executed synchronously with the jobnet connector.
- `n`: The root jobnet is executed asynchronously with the jobnet connector.

`ncex={y|n};`

If the execution order of a root jobnet is to be controlled, define whether to enable linkage between scheduler services. If you omit this option, the system assumes `n`.

You can specify this option only for a root jobnet.

If you specify this option when `y` has not been specified for the `ncl` parameter, an error occurs.

- `y`: Linkage between scheduler services is enabled.

Linkage with jobnet connectors defined on other hosts or in other scheduler services is possible.

- `n`: Linkage between scheduler services is disabled.

Linkage with jobnet connectors defined in only the same scheduler service is possible.

`nchn="connection-host-name";`

Specify the name of the host on which the jobnet connector to be connected has been defined. You can specify a character string of 1 to 255 bytes. You cannot specify spaces, tab characters, or linefeed characters.

You can specify this option only for a root jobnet. If you specify this option when `y` has not been specified for the `ncex` parameter, an error occurs.

If you want to use a double quotation mark (") or a hash mark (#) as a character, prefix the character by #. That is, use # " instead of " and use ## instead of #.

`ncsv=connection-service-name;`

Specify the name of the scheduler service in which the jobnet connector to be connected has been defined. You can specify a character string of 1 to 30 bytes.

You can specify this option only for a root jobnet. If you specify this option when `y` has not been specified for the `ncex` parameter, an error occurs.

`mm={and|or};`

Define the wait method with respect to the specified units whose ends are being waited for.

The default is `and`.

- `and`: Start executing at completion of all units whose ends are being waited for.
- `or`: Start executing at completion of one of the units whose ends are being waited for.

`nmg={y|n};`

Define the behavior when there are no generations of the root jobnet for the specified unit whose end is being waited for.

The default is `n`.

- `y`: Start executing.
- `n`: Do not start executing.

`eun=name-of-the-unit-whose-end-is-being-waited-for;`

Define the full-path name of a unit whose end is being waited for.

To specify multiple units, repeat the parameter. You can specify a maximum of 32 units.

You can use a character string of 1 to 930 bytes as the unit name.

`ega={exec|execdeffer|none};`

Specify the behavior when a jobnet with start conditions is specified as the jobnet whose end is being waited for and the execution generation ends abnormally.

If you omit this option, the system assumes `none`.

- `exec`: Start executing.
- `execdeffer`: Do not start executing. However, if the execution generation is in the *Skipped so not exe.* status, start executing.
- `none`: Do not start executing.

`uem={y|n};`

Specify the behavior when a jobnet with start conditions is specified as the jobnet whose end is being waited for and the monitoring generation is in the *Unmonitored + Ended* status.

If you omit this option, the system assumes `n`.

- y: Start executing.
- n: Do not start executing.

5.2.5 Manager unit definition

This paragraph explains how to specify a manager unit definition.

The following gives the format of, and the parameters for a manager unit definition.

Format

```
[mh="manager-host-name";]
[mu=manager-unit-name;]
```

Parameters

`mh="manager-host-name";`

Define the name of the JP1/AJS3 - Manager host.

You can set a character string of 1 to 255 bytes.

`mu=manager-unit-name;`

Define the full-path unit name of a manager.

You can set a character string of 1 to 961 bytes.

5.2.6 UNIX/PC job definition

This paragraph explains how to specify a definition for a UNIX/PC job.

The following gives the format of, and the parameters for a UNIX/PC job definition.

Format

```
[te="command-text";]
[sc="script-file-name";]
[prm="parameter";]
[wkp="work-path-name";]
[ev="environmental-variable-file-name";]
[env="environment-variable";]...
[si="standard-input-file-name";]
[so="standard-output-file-name";]
[se="standard-error-output-file-name";]
[soa={new|add};]
[sea={new|add};]
[etm=n;]
[fd=time-required-for-execution;]
[pr=n;]
[ex="execution-agent-name";]
[un="target-user-name";]
[jd={nm|ab|cod|mdf|exf};]
[wth=n;]
[tho=n;]
[jdf="end-judgment-file-name";]
[abr={y|n};]
```

```
[rjs=lower-limit-of-return-codes-to-be-retried-automatically;]
[rje=upper-limit-of-return-codes-to-be-retried-automatically;]
[rec=maximum-number-of-retry-executions;]
[rei=retry-interval;]
[ts1="transfer-source-file-name-1";]
[td1="transfer-destination-file-name-1";]
[top1={sav|del};]
[ts2="transfer-source-file-name-2";]
[td2="transfer-destination-file-name-2";]
[top2={sav|del};]
[ts3="transfer-source-file-name-3";]
[td3="transfer-destination-file-name-3";]
[top3={sav|del};]
[ts4="transfer-source-file-name-4";]
[td4="transfer-destination-file-name-4";]
[top4={sav|del};]
[ha={y|n};]
[eu={ent|def};]
[jty={q|n};]
[mm={and|or};]
[nmg={y|n};]
[eun=name-of-the-unit-whose-end-is-being-waited-for;]
[ega={exec|execdefer|none};]
[uem={y|n};]
```

Parameters

`te="command-text";`

Define command text. You can set a character string of 1 to 1,023 bytes.

If you want to use a double quotation mark (") or a hash mark (#) as a character, prefix the character by #. That is, use #" instead of " and use ## instead of #.

The command text can contain macro variables. In that case, you can set a character string of 1 to 1,023 bytes using the "*macro-variable-name:passing-information-name*" format. Set *macro-variable-name* as a character string of no more than 64 bytes, using the format ?AJS2xxxx?. In the xxxxx part, you can use uppercase alphabetic characters (A to Z), numerals (0 to 9), and periods (.).

`sc="script-file-name";`

For the Unix job, define a script file name on the agent host where the job is executed. For the PC job, define an execution file name on the agent host.

You can set a character string of 1 to 511 bytes. You can use either an absolute or relative path to specify the file name. If you specify a relative path, the system assumes it to be a relative path from the work path for job execution.

If you want to use a double quotation mark (") or a hash mark (#) as a character, prefix the character by #. That is, use #" instead of " and use ## instead of #.

The file name can contain macro variables. In that case, you can set a character string of 1 to 511 bytes using the "*macro-variable-name:passing-information-name*" format. Set *macro-variable-name* as a character string of no more than 64 bytes, using the format ?AJS2xxxx?. In the xxxxx part, you can use uppercase alphabetic characters (A to Z), numerals (0 to 9), and periods (.).

`prm="parameter";`

Define a parameter for the target file.

You can set a character string of 1 to 1,023 bytes.

If you want to use a double quotation mark (") or a hash mark (#) as a character, prefix the character by #. That is, use #" instead of " and use ## instead of #.

The parameter can contain macro variables. In that case, you can set a character string of 1 to 1,023 bytes using the "*macro-variable-name:passing-information-name*" format. Set *macro-variable-name* as a character string of no more than 64 bytes, using the format ?AJS2xxxx?. In the *xxxxx* part, you can use uppercase alphabetic characters (A to Z), numerals (0 to 9), and periods (.).

```
wkp="work-path-name";
```

Define the work path name using a full path name.

You can set a character string of 1 to 511 bytes.

If you want to use a double quotation mark (") or a hash mark (#) as a character, prefix the character by #. That is, use #" instead of " and use ## instead of #.

If the job has the queuing attribute (jty=q), you can specify a macro variable.

```
ev="environment-variable-file-name";
```

Define the environmental variable file name for the agent host.

You can set a character string of 1 to 511 bytes. You can use either an absolute or relative path to specify the file name. If you specify a relative path, the system assumes it to be a relative path from the work path for job execution.

If you want to use a double quotation mark (") or a hash mark (#) as a character, prefix the character by #. That is, use #" instead of " and use ## instead of #.

If the job has the queuing attribute (jty=q), you can specify a macro variable.

```
env="environment-variable";
```

Define an environment variable using the "*environment-variable-name=value*" format.

You can set a character string of 1 to 20,479 bytes.

If you want to use a double quotation mark (") or a hash mark (#) as a character, prefix the character by #. That is, use #" instead of " and use ## instead of #.

The environment variable can contain macro variables. In that case, you can set a character string of 1 to 20,479 bytes using the "*macro-variable-name:passing-information-name*" format. Set *macro-variable-name* as a character string of no more than 64 bytes, using the format ?AJS2xxxx?. In the *xxxxx* part, you can use uppercase alphabetic characters (A to Z), numerals (0 to 9), and periods (.).

The environment variable can contain macro variables. In that case, you can set a character string of 1 to 20,479 bytes using the "?AJS2xxxxxxxx?:*passing-information-name*" format. Note that you can set a character string of 1 to 64 bytes in the ?AJS2xxxxxxxx? part; only uppercase alphabetic characters and periods (.) can be used in the *xxxxxxxx* part.

```
si="standard-input-file-name";
```

Define a file name for standard input on the agent host where the job is executed.

You can set a character string of 1 to 511 bytes. You can use either an absolute or relative path to specify the file name. If you specify a relative path, the system assumes it to be a relative path from the work path for job execution.

If you want to use a double quotation mark (") or a hash mark (#) as a character, prefix the character by #. That is, use #" instead of " and use ## instead of #.

If the job has the queuing attribute (jty=q), you can specify a macro variable.

```
so="standard-output-file-name";
```

Define a file name for standard output on the agent host where the job is executed.

You can set a character string of 1 to 511 bytes. You can use either an absolute or relative path to specify the file name. If you specify a relative path, the system assumes it to be a relative path from the work path for job execution.

If you want to use a double quotation mark (") or a hash mark (#) as a character, prefix the character by #. That is, use #" instead of " and use ## instead of #.

If the job has the queuing attribute (jty=q), by specifying \$JP1AJS2_JPQSTDOUTTEMP\$ you can output the standard output file as a temporary file.

You can also specify a macro variable if the job has the queuing attribute (jty=q).

```
se="standard-error-output-file-name";
```

Define a file name for standard error output on the agent host where the job is executed.

You can set a character string of 1 to 511 bytes. You can use either an absolute or relative path to specify the file name. If you specify a relative path, the system assumes it to be a relative path from the work path for job execution.

If you want to use a double quotation mark (") or a hash mark (#) as a character, prefix the character by #. That is, use #" instead of " and use ## instead of #.

If the job has the queuing attribute (jty=q), you can specify a macro variable.

```
soa={new|add};
```

Define an append option for a standard output file name. The default is *new*. This parameter is valid only when the standard output file name is specified in the *so* parameter.

- *new*: Creates a new file.
- *add*: Adds information to an existing file.

```
sea={new|add};
```

Define an append option for a standard error output file name. The default is *new*. This parameter is valid only when the name of the standard error output file is specified in the *se* parameter.

- *new*: Creates a new file.
- *add*: Adds information to an existing file.

```
etm=n;
```

Define the time-out period using the relative minutes from the start time.

You can set 1 to 1,440 minutes.

```
fd=time-required-for-execution;
```

Define the time-required-for-execution within which the job is expected to be terminated.

You can specify a decimal value between 1 and 1,440 (minutes).

```
pr=n;
```

Define the priority of job execution.

You can set 1 to 5. The lowest priority of execution is 1, while the highest priority is 5. The default value depends on the definition of the upper-level jobnets. If this parameter is not specified, and if the *pr* parameter and the *ni* parameter of all upper-level jobnets of the job are not specified, the priority of the job is assumed to be the value specified for the *DEFAULTPRIORITY* environment setting parameter (If no value is specified for the *DEFAULTPRIORITY* environment setting parameter, then the priority is assumed to be 1). For details about the *DEFAULTPRIORITY* environment setting parameter, see 20.4.2(108) *DEFAULTPRIORITY* in the *JP1/Automatic Job Management System 3 Configuration Guide*.

```
ex="execution-agent-name";
```

Define the name of the execution agent or execution agent group that is used to execute jobs.

You can set a character string of 1 to 255 bytes.

If you want to use a double quotation mark (") or a hash mark (#) as a character, prefix the character with #. That is, use #" instead of ", and use ## instead of #.

If the job has the queuing attribute (`jty=q`), you can specify a macro variable.

```
un="execution-user-name";
```

Define the name of the OS user responsible for executing a job in the agent host.

You can set a character string of 1 to 63 bytes. You cannot specify a space character in the user name.

If you want to use a double quotation mark (") or a hash mark (#) as a character, prefix the character by #. That is, use #" instead of " and use ## instead of #.

If the job has the queuing attribute (`jty=q`), you can specify a macro variable.

```
jd={nm|ab|cod|mdf|exf};
```

Define the type of end judgment. The default is `cod`.

If you specify a value other than `cod`, you cannot specify the `rjs`, `rje`, `rec`, and `rei` parameters. In addition, you cannot specify `y` for the `abr` parameter. If you specify `y`, unit creation fails.

- `nm`: Always assumes a normal end.
- `ab`: Always assumes an abnormal end.
- `cod`: Normal end if the return code is below a set value
- `mdf`: Normal end if the file is refreshed during the period between the start and the end of job execution
- `exf`: Normal end if a file is created at the end of job execution

```
wth=n;
```

Define the warning threshold.

You can set 0 to 2,147,483,647.

```
tho=n;
```

Define the abnormal threshold.

You can set 0 to 2,147,483,647. The default is 0.

```
jdf="end-judgment-file-name";
```

Define an end judgment file name on the agent host for job execution.

You can set a character string of 1 to 511 bytes. You can use either an absolute or relative path to specify the file name. If you specify a relative path, the system assumes it to be a relative path from the work path for job execution.

If you want to use a double quotation mark (") or a hash mark (#) as a character, prefix the character by #. That is, use #" instead of " and use ## instead of #.

If the job has the queuing attribute (`jty=q`), you can specify a macro variable.

```
abr={y|n};
```

Define whether retrying on an abnormal end is enabled. If you omit this option, the system assumes `n`.

You can specify `y` only when you specify `cod` for the `jd` parameter.

- `y`: Automatic retries are performed if an abnormal end occurs.
- `n`: Automatic retries are not performed if an abnormal end occurs.

```
rjs=lower-limit-of-return-codes-to-be-retried-automatically;
```

Define the lower limit of the return codes to be retried automatically if an abnormal end occurs.

This option can be specified only if automatic retrying is performed when an abnormal end occurs (`y` is specified for the `abr` parameter).

You can specify a value from 1 to 4,294,967,295. If you specify a value equal to or smaller than the abnormal threshold (the `tho` parameter) and a value greater than the upper limit on return codes to be automatically retried (the `rie` parameter), unit creation fails.

If this option is omitted, a lower limit for the return codes to be retried automatically is not defined, and *abnormal-threshold* + 1 is assumed when the job is executed.

`rije=upper-limit-of-return-codes-to-be-retried-automatically;`

Define the upper limit of the return codes to be retried automatically if an abnormal end occurs.

This option can be specified only if automatic retrying is performed when an abnormal end occurs (`y` is specified for the `abr` parameter).

You can specify a value from 1 to 4,294,967,295. If you specify a value equal to or smaller than the abnormal threshold (the `tho` parameter) and a value smaller than the lower limit of the return codes to be retried automatically (the `ris` parameter), unit creation fails.

If this option is omitted, an upper limit of the return codes to be automatically retried is not defined, and the maximum value (4,294,967,295) is assumed when the job is executed.

`rec=maximum-number-of-retry-executions;`

Define the maximum number of retry executions only when automatic retry is performed for an abnormal end (`y` is specified for the `abr` parameter).

You can specify a value from 1 to 12 (times). If you omit this option, the system assumes 1.

`rei=retry-interval;`

Define the retry interval only when automatic retrying is performed for an abnormal end (`y` is specified for the `abr` parameter).

You can specify a value from 1 to 10 (minutes). If you omit this option, the system assumes 1.

`ts1="transfer-source-file-name-1";`

Define a full-path transfer source file name.

You can set a character string of 1 to 511 bytes.

If you want to use a double quotation mark (") or a hash mark (#) as a character, prefix the character by #. That is, use #" instead of " and use ## instead of #.

If the job has the queuing attribute (`jtY=q`), you can specify a macro variable.

`td1="transfer-destination-file-name-1";`

Define the name of a transfer destination file to be transferred to the agent host.

You can set a character string of 1 to 511 bytes. The default is the `$JP1AJS2_JPQTEMPxx$` variable, where the `xx` part refers to the number of the transfer file ranging from 01 to 04. If this variable is assigned to the `sc` and `prm` parameters, you can execute the job without having to be aware of the transfer destination file name. If this variable is assigned to the `sc` and `prm` parameters, you can execute the job without having to be aware of the transfer destination file name.

If you want to use a double quotation mark (") or a hash mark (#) as a character, prefix the character by #. That is, use #" instead of " and use ## instead of #.

If the job has the queuing attribute (`jtY=q`), you can specify a macro variable.

`top1={sav|del};`

Define the option to automatically delete the transfer destination file.

- `sav`: Saves the file.
- `del`: Deletes the file.

If you specify transfer source and destination file names with this parameter omitted, the system defaults to `sav`.

If you specify a transfer source file name without specifying a transfer destination file name and this parameter, this parameter defaults to `del`.

```
ts2="transfer-source-file-name-2";
```

Define a full-path transfer source file name.

You can set a character string of 1 to 511 bytes.

If you want to use a double quotation mark (") or a hash mark (#) as a character, prefix the character by #. That is, use # " instead of " and use ## instead of #.

If the job has the queuing attribute (`jtY=q`), you can specify a macro variable.

```
td2="transfer-destination-file-name-2";
```

Define the name of a transfer destination file to be transferred to the agent host.

You can set a character string of 1 to 511 bytes. The default is the `$JP1AJS2_JPQTEMPxx$` variable, where the `xx` part refers to the number of the transfer file ranging from 01 to 04. If this variable is assigned to the `sc` and `prm` parameters, you can execute the job without having to be aware of the transfer destination file name.

If you want to use a double quotation mark (") or a hash mark (#) as a character, prefix the character by #. That is, use # " instead of " and use ## instead of #.

If the job has the queuing attribute (`jtY=q`), you can specify a macro variable.

```
top2={sav|del};
```

Define the option to automatically delete the transfer destination file.

- `sav`: Saves the file.
- `del`: Deletes the file.

If you specify transfer source and destination file names with this parameter omitted, the system defaults to `sav`.

If you specify a transfer source file name without specifying a transfer destination file name and this parameter, this parameter defaults to `del`.

```
ts3="transfer-source-file-name-3";
```

Define a full-path transfer source file name.

You can set a character string of 1 to 511 bytes.

If you want to use a double quotation mark (") or a hash mark (#) as a character, prefix the character by #. That is, use # " instead of " and use ## instead of #.

If the job has the queuing attribute (`jtY=q`), you can specify a macro variable.

```
td3="transfer-destination-file-name-3";
```

Define the name of a transfer destination file to be transferred to the agent host.

You can set a character string of 1 to 511 bytes. The default is the `$JP1AJS2_JPQTEMPxx$` variable, where the `xx` part refers to the number of the transfer file ranging from 01 to 04. If this variable is assigned to the `sc` and `prm` parameters, you can execute the job without having to be aware of the transfer destination file name.

If you want to use a double quotation mark (") or a hash mark (#) as a character, prefix the character by #. That is, use # " instead of " and use ## instead of #.

If the job has the queuing attribute (`jtY=q`), you can specify a macro variable.

```
top3={sav|del};
```

Define the option to automatically delete the transfer destination file.

- `sav`: Saves the file.
- `del`: Deletes the file.

If you specify transfer source and destination file names with this parameter omitted, the system defaults to `sav`.

If you specify a transfer source file name without specifying a transfer destination file name and this parameter, this parameter defaults to `del`.

```
ts4="transfer-source-file-name-4";
```

Define a full-path transfer source file name.

You can set a character string of 1 to 511 bytes.

If you want to use a double quotation mark (") or a hash mark (#) as a character, prefix the character by #. That is, use # " instead of " and use ## instead of #.

If the job has the queuing attribute (`jty=q`), you can specify a macro variable.

```
td4="transfer-destination-file-name-4";
```

Define the name of a transfer destination file to be transferred to the agent host.

You can set a character string of 1 to 511 bytes. The default is the `$JP1AJS2_JPQTEMPxx$` variable, where the `xx` part refers to the number of the transfer file ranging from 01 to 04. If this variable is assigned to the `sc` and `prm` parameters, you can execute the job without having to be aware of the transfer destination file name.

If you want to use a double quotation mark (") or a hash mark (#) as a character, prefix the character by #. That is, use # " instead of " and use ## instead of #.

If the job has the queuing attribute (`jty=q`), you can specify a macro variable.

```
top4={sav|del};
```

Define the option to automatically delete the transfer destination file.

- `sav`: Saves the file.
- `del`: Deletes the file.

If you specify transfer source and destination file names with this parameter omitted, the system defaults to `sav`.

If you specify a transfer source file name without specifying a transfer destination file name and this parameter, this parameter defaults to `del`.

```
ha={y|n};
```

Define whether to suspend job execution. The default is `n`.

- `y`: Suspends job execution.
- `n`: Does not suspend job execution.

```
eu={ent|def};
```

Define the JP1 user who executes the job. The default is `ent`.

- `ent`: The JP1 user who registered the jobnet executes the job.
- `def`: The JP1 user who owns the job executes the job.

```
jty={q|n};
```

Define whether the job has the queuing attribute. The default is `q`.

- `q`: Has the queuing attribute.
- `n`: Does not have the queuing attribute.

```
mm={and|or};
```

Define the wait method with respect to the specified units whose ends are being waited for.

The default is `and`.

- `and`: Start executing at completion of all units whose ends are being waited for.
- `or`: Start executing at completion of one of the units whose ends are being waited for.

nmg={ y | n } ;

Define the behavior when there are no generations of the root jobnet for the specified unit whose end is being waited for.

The default is n.

- y: Start executing.
- n: Do not start executing.

eun=*name-of-the-unit-whose-end-is-being-waited-for* ;

Define the full-path name of a unit whose end is being waited for.

To specify multiple units, repeat the parameter. You can specify a maximum of 32 units.

You can use a character string of 1 to 930 bytes as the unit name.

ega={ exec | execdeffer | none } ;

Specify the behavior when a jobnet with start conditions is specified as the jobnet whose end is being waited for and the execution generation ends abnormally.

If you omit this option, the system assumes none.

- exec: Start executing.
- execdeffer: Do not start executing. However, if the execution generation is in the *Skipped so not exe.* status, start executing.
- none: Do not start executing.

uem={ y | n } ;

Specify the behavior when a jobnet with start conditions is specified as the jobnet whose end is being waited for and the monitoring generation is in the *Unmonitored + Ended* status.

If you omit this option, the system assumes n.

- y: Start executing.
- n: Do not start executing.

5.2.7 QUEUE job definition

This paragraph explains how to specify a definition for a QUEUE job.

The following gives the format of, and the parameters for a QUEUE job definition.

Format

```
[qu="queue-name" ; ]
[qm="host-name" ; ]
[req="job-name" ; ]
[sc="script-file-name" ; ]
[prm="parameter" ; ]
[fd=time-required-for-execution ; ]
[pr=n ; ]
[jd={ nm | ab | cod } ; ]
[wth=n ; ]
[tho=n ; ]
[abr={ y | n } ; ]
[rjs=lower-limit-of-return-codes-to-be-retried-automatically ; ]
[rje=upper-limit-of-return-codes-to-be-retried-automatically ; ]
```

```
[rec=maximum-number-of-retry-executions];
[rei=retry-interval];
[ts1=transfer-source-file-name-1];
[td1=transfer-destination-file-name-1];
[ts2=transfer-source-file-name-2];
[td2=transfer-destination-file-name-2];
[ts3=transfer-source-file-name-3];
[td3=transfer-destination-file-name-3];
[ts4=transfer-source-file-name-4];
[td4=transfer-destination-file-name-4];
[ha={y|n}];
[eu={ent|def}];
[mm={and|or}];
[nmg={y|n}];
[eun=name-of-the-unit-whose-end-is-being-waited-for];
[ega={exec|execdefer|none}];
[uem={y|n}];
```

Parameters

`qu="queue-name";`

Define the name of the queue to which a QUEUE job is submitted.

You can set a character string of 1 to 63 bytes.

If you want to use a double quotation mark (") or a hash mark (#) as a character, prefix the character by #. That is, use #" instead of " and use ## instead of #.

You can specify a macro variable.

`qm="host-name";`

Define the JP1/AJS3 - Manager host name and the JP1/OJE for VOS3 host name for linkage. The default is the local host name. You can set a character string of 1 to 255 bytes. If you want to use a double quotation mark (") or a hash mark (#) as a character, prefix the character by #. That is, use #" instead of " and use ## instead of #.

You can specify a macro variable.

`req="job-name";`

Define a job name to submit a QUEUE job.

You can set a character string of 1 to 63 bytes. The default is the unit name of a QUEUE job.

If you want to use a double quotation mark (") or a hash mark (#) as a character, prefix the character by #. That is, use #" instead of " and use ## instead of #.

You can specify a macro variable.

`sc="script-file-name";`

Define an execution file name.

You can set a character string of 1 to 511 bytes.

If you want to use a double quotation mark (") or a hash mark (#) as a character, prefix the character by #. That is, use #" instead of " and use ## instead of #.

You can specify a macro variable.

`prm="parameter";`

Define a parameter for the execution file.

You can set a character string of 1 to 1,023 bytes.

If you want to use a double quotation mark (") or a hash mark (#) as a character, prefix the character by #. That is, use #" instead of " and use ## instead of #.

You can specify a macro variable.

`fd=time-required-for-execution;`

Define the time-required-for-execution within which the job is expected to be terminated.

You can specify a decimal value between 1 and 1,440 (minutes).

`pr=n;`

Define the priority of job execution.

You can set 1 to 5. The lowest priority of execution is 1, while the highest priority is 5. The default depends on the definition of the upper-level jobnet. If this parameter is not specified, and if the `pr` parameter and the `ni` parameter of all upper-level jobnets of the job are not specified, the priority of the job is assumed to be the value specified for the `DEFAULTPRIORITY` environment setting parameter (If no value is specified for the `DEFAULTPRIORITY` environment setting parameter, then the priority is assumed to be 1). For details about the `DEFAULTPRIORITY` environment setting parameter, see *20.4.2(108) DEFAULTPRIORITY* in the *JPI/Automatic Job Management System 3 Configuration Guide*.

`jd={nm|ab|cod};`

Define the type of end judgment. The default is `cod`.

If you specify a value other than `cod`, you cannot specify `y` for the `abr` parameter. If you specify `y`, the KAVS0674-E message is output, and the unit cannot be created.

- `nm`: Always assumes a normal end.
- `ab`: Always assumes an abnormal end.
- `cod`: Normal end if the return code is below a set value.

`wth=n;`

Define the threshold for the end with warning.

You can set 0 to 2,147, 483, 647.

`tho=n;`

Define the threshold for the abnormal end.

You can set 0 to 2,147, 483, 647. The default is 0.

`abr={y|n};`

Define whether retrying on an abnormal end is enabled. If you omit this option, the system assumes `n`.

You can specify `y` only when you specify `cod` for the `jd` parameter.

- `y`: Automatic retries are performed if an abnormal end occurs.
- `n`: Automatic retries are not performed if an abnormal end occurs.

`rjs=lower-limit-of-return-codes-to-be-retried-automatically;`

Define the lower limit of the return codes to be retried automatically when automatic retrying is performed for an abnormal end.

You can define the lower limit only when you specify `y` for the `abr` parameter.

You can specify a value from 1 to 4,294,967,295. If you specify a value equal to or smaller than the abnormal threshold and a value greater than the upper limit of the return codes to be retried automatically, the KAVS0668-E message is output, and the unit cannot be created.

If you omit this option, the system assumes *abnormal-threshold* + 1 when the job is executed.

`rje=upper-limit-of-return-codes-to-be-retried-automatically;`

Define the upper limit of the return codes to be retried automatically if automatic retrying is performed for an abnormal end.

You can define the upper limit only when you specify `y` for the `abr` parameter.

You can specify a value from 1 to 4,294,967,295. If you specify a value equal to or smaller than the abnormal threshold and a value smaller than the lower limit of the return codes to be retried automatically, the KAVS0668-E message is output, and unit creation fails.

If you omit this option, the system assumes the maximum value (4,294,967,295) when the job is executed.

rec=maximum-number-of-retry-executions;

Define the maximum number of retry executions when automatic retrying is performed for an abnormal end.

You can specify this parameter only when you specify *y* for the *abr* parameter.

You can specify a value from 1 to 12 (times). If you omit this option, the system assumes 1.

rei=retry-interval;

Define the retry interval when automatic retrying is performed for an abnormal end.

You can specify this parameter only when you specify *y* for the *abr* parameter.

You can specify a value from 1 to 10 (minutes). If you omit this option, the system assumes 1.

ts1="transfer-source-file-name-1";

Define a full-path transfer source file name.

You can set a character string of 1 to 511 bytes.

If you want to use a double quotation mark (") or a hash mark (#) as a character, prefix the character by #. That is, use # " instead of " and use ## instead of #.

You can specify a macro variable.

td1="transfer-destination-file-name-1";

Define the name of a transfer destination file to be transferred to the agent host.

You can set a character string of 1 to 511 bytes.

If you want to use a double quotation mark (") or a hash mark (#) as a character, prefix the character by #. That is, use # " instead of " and use ## instead of #.

You can specify a macro variable.

ts2="transfer-source-file-name-2";

Define a full-path transfer source file name.

You can set a character string of 1 to 511 bytes.

If you want to use a double quotation mark (") or a hash mark (#) as a character, prefix the character by #. That is, use # " instead of " and use ## instead of #.

You can specify a macro variable.

td2="transfer-destination-file-name-2";

Define the name of a transfer destination file to be transferred to the agent host.

You can set a character string of 1 to 511 bytes.

If you want to use a double quotation mark (") or a hash mark (#) as a character, prefix the character by #. That is, use # " instead of " and use ## instead of #.

You can specify a macro variable.

ts3="transfer-source-file-name-3";

Define a full-path transfer source file name.

You can set a character string of 1 to 511 bytes.

If you want to use a double quotation mark (") or a hash mark (#) as a character, prefix the character by #. That is, use # " instead of " and use ## instead of #.

You can specify a macro variable.

`td3="transfer-destination-file-name-3";`

Define the name of a transfer destination file to be transferred to the agent host.

You can set a character string of 1 to 511 bytes.

If you want to use a double quotation mark (") or a hash mark (#) as a character, prefix the character by #. That is, use #" instead of " and use ## instead of #.

You can specify a macro variable.

`ts4="transfer-source-file-name-4";`

Define a full-path transfer source file name.

You can set a character string of 1 to 511 bytes.

If you want to use a double quotation mark (") or a hash mark (#) as a character, prefix the character by #. That is, use #" instead of " and use ## instead of #.

You can specify a macro variable.

`td4="transfer-destination-file-name-4";`

Define the name of a transfer destination file to be transferred to the agent host.

You can set a character string of 1 to 511 bytes.

If you want to use a double quotation mark (") or a hash mark (#) as a character, prefix the character by #. That is, use #" instead of " and use ## instead of #.

You can specify a macro variable.

`ha={y|n};`

Define whether to suspend job execution. The default is n.

- y: Suspends job execution.
- n: Does not suspend job execution.

`eu={ent|def};`

Define the JP1 user who executes the job. The default is ent.

- ent: The JP1 user who registered the jobnet executes the job.
- def: The JP1 user who owns the job executes the job.

`mm={and|or};`

Define the wait method with respect to the specified units whose ends are being waited for.

The default is and.

- and: Start executing at completion of all units whose ends are being waited for.
- or: Start executing at completion of one of the units whose ends are being waited for.

`nmg={y|n};`

Define the behavior when there are no generations of the root jobnet for the specified unit whose end is being waited for.

The default is n.

- y: Start executing.
- n: Do not start executing.

`eun=name-of-the-unit-whose-end-is-being-waited-for;`

Define the full-path name of a unit whose end is being waited for.

To specify multiple units, repeat the parameter. You can specify a maximum of 32 units.

You can use a character string of 1 to 930 bytes as the unit name.

```
ega={exec|execdeffer|none};
```

Specify the behavior when a jobnet with start conditions is specified as the jobnet whose end is being waited for and the execution generation ends abnormally.

If you omit this option, the system assumes none.

- `exec`: Start executing.
- `execdeffer`: Do not start executing. However, if the execution generation is in the *Skipped so not exe.* status, start executing.
- `none`: Do not start executing.

```
uem={y|n};
```

Specify the behavior when a jobnet with start conditions is specified as the jobnet whose end is being waited for and the monitoring generation is in the *Unmonitored + Ended* status.

If you omit this option, the system assumes n.

- `y`: Start executing.
- `n`: Do not start executing.

5.2.8 Judgment job definition

This paragraph explains how to specify a judgment job definition.

The following gives the format of, and the parameters for a judgment job definition.

Format

```
[ej={gt|ge|lt|le|eq|ne|ri|ro|ef|nf|vgt|vge|vlt|vle|veq|vne|vri|vro|sce|spe|sne|spn|snn|snl};]
[ejc=judgment-return-code;]
[ejl=lower-limit-of-judgment-return-codes;]
[ejh=upper-limit-of-judgment-return-codes;]
[ejf="end-judgment-file-name";]
[ejv=variable-name;]
[ejt="judgment-value-for-variable (string)";]
[eji=judgment-value-for-variable (numeric);]
[ejs=lower-limit-judgment-value-for-variable_ (numeric);]
[ejg=upper-limit-judgment-value-for-variable_ (numeric);]
[ejm={gt|ge};]
[eju={lt|le};]
[ha={y|n};]
```

Parameters

```
ej={gt|ge|lt|le|eq|ne|ri|ro|ef|nf|vgt|vge|vlt|vle|veq|vne|vri|vro|sce|spe|sne|spn|snn|snl};
```

Define judgment conditions for comparing the return code of the preceding job with the reference value. You can specify only one judgment condition. The default is `gt`.

- `gt`: The return code of the preceding job is greater than the reference value. You cannot specify this option together with `ejf="end-judgment-file-name";`.
- `ge`: The return code of the preceding job is equal to or greater than the reference value. You cannot specify this option together with `ejf="end-judgment-file-name";`.

- `lt`: The return code of the preceding job is smaller than the reference value. You cannot specify this option together with `ejf="end-judgment-file-name" ;`.
- `le`: The return code of the preceding job is equal to or smaller than the reference value. You cannot specify this option together with `ejf="end-judgment-file-name" ;`.
- `eq`: The return code of the preceding job is equal to the reference value. You cannot specify this option together with `ejf="end-judgment-file-name" ;`.
- `ne`: The return code of the preceding job is not equal to the reference value. You cannot specify this option together with `ejf="end-judgment-file-name" ;`.
- `ri`: The return code of the preceding job is within the judgment value range. You cannot specify this option together with `ejf="end-judgment-file-name" ;`. You must also specify the `ejl` and `ejh` options. If necessary, specify `ejm` and `aju`.
- `ro`: The return code of the preceding job is outside the judgment value range. You cannot specify this option together with `ejf="end-judgment-file-name" ;`. You must also specify the `ejl` and `ejh` options. If necessary, specify `ejm` and `aju`.
- `ef`: A file is created. You cannot specify this option together with `ejc=judgment-return-code ;`.
- `nf`: No file is created. You cannot specify this option together with `ejc=judgment-return-code ;`.
- `vgt`: The value of the specified variable is greater than the judgment value. `aji` is treated as a numerical value.
- `vge`: The value of the specified variable is equal to or greater than the judgment value. `aji` is treated as a numerical value.
- `vlt`: The value of the specified variable is smaller than the judgment value. `aji` is treated as a numerical value.
- `vle`: The value of the specified variable is equal to or smaller than the judgment value. `aji` is treated as a numerical value.
- `veq`: The value of the specified variable is equal to the judgment value. `aji` is treated as a numerical value.
- `vne`: The value of the specified variable is not equal to the judgment value. `aji` is treated as a numerical value.
- `vri`: The specified variable value is within the judgment value range. `ajs` and `ajg` are treated as numeric values. You must also specify `ajs` and `ajg`. If necessary, specify `ejm` and `aju`.
- `vro`: The specified variable value is outside the judgment value range. `ajs` and `ajg` are treated as numeric values. You must also specify `ajs` and `ajg`. If necessary, specify `ejm` and `aju`.
- `sce`: The value of the specified variable is equal to the judgment value. `ajt` is treated as a character string.
- `spe`: The value of the specified variable contains the judgment value. `ajt` is treated as a character string.
- `sne`: The value of the specified variable is not equal to the judgment value. `ajt` is treated as a character string.
- `spn`: The value of the specified variable does not contain the judgment value. `ajt` is treated as a character string. You must also specify `ajv` and `ajt`.
- `snn`: There is a value for the specified variable. `ajt` is not processed.
- `snl`: There is no value for the specified variable. `ajt` is not processed.

`ejc=judgment-return-code ;`

Define the judgment return code for judgment. The default value is 0.

You can set 0 to 4,294,967,295.

This parameter takes effect if you specify `gt`, `ge`, `lt`, `le`, `eq`, or `ne` for the `ej` parameter. If you specify another value, this parameter does not take effect.

`ejl=lower-limit-judgment-return-code;`

Define the lower limit judgment return code used in making a judgment.

You can specify a value from 0 to 4,294,967,295. If there is no integer value in the range used to judge the return code from the lower limit judgment return code (`ejl` parameter) and the boundary condition (`ejm` parameter) to the upper limit judgment return code (`ejh` parameter) and the boundary condition (`aju` parameter), an error occurs.

If you specify `ri` or `ro` for the `ej` parameter, this parameter takes effect. If you specify another value, this parameter does not take effect.

If the return code is a negative value, judgment can be performed by specifying a value that converts to an unsigned integer. For example, `-1` is treated as `4,294,967,295` in Windows, and as `255` in UNIX. Note, however, that if a negative number in an return code is converted to an unsigned integer, it falls within the range from `2,147,483,648` to `4,294,967,295`. Accordingly, if the lower limit of the return code is a negative value and the upper limit is a positive value, the range cannot be specified.

`ejh=upper-limit-judgment-return-code;`

Define the upper limit judgment return code used in making a judgment.

You can specify a value from 0 to 4,294,967,295. If there is no integer value in the range used to judge the return code from the lower limit judgment return code (`ejl` parameter) and the boundary condition (`ejm` parameter) to the upper limit judgment return code (`ejh` parameter) and the boundary condition (`aju` parameter), an error occurs.

If you specify `ri` or `ro` for the `ej` parameter, this parameter takes effect. If you specify another value, this parameter does not take effect.

If the return code is a negative value, judgment can be performed by specifying a value that converts to an unsigned integer. For example, `-1` is treated as `4,294,967,295` in Windows, and as `255` in UNIX. Note, however, that if a negative number in an return code is converted to an unsigned integer, it falls within the range from `2,147,483,648` to `4,294,967,295`. Accordingly, if the lower limit of the return code is a negative value and the upper limit is a positive value, the range cannot be specified.

`ejf="end-judgment-file-name";`

Define the file name of a file subject to end judgment.

You can set a character string of 1 to 260 bytes. This parameter takes effect when `ef` or `nf` is specified for the `ej` parameter. If you specify another value, this parameter does not take effect.

If you want to use a double quotation mark (`"`) or a hash mark (`#`) as a character, prefix the character by `#`. That is, use `#"` instead of `"` and use `##` instead of `#`.

`ejv=variable-name;`

Using the `?AJS2xxxx?` format, specify the macro variable name specified in the preceding job. If you specify `vgt`, `vge`, `vlt`, `vle`, `veq`, `vne`, `vri`, `vro`, `sce`, `spe`, `sne`, `spn`, `snn`, or `snl` for the `ej` parameter, this parameter takes effect. If you specify another value, this parameter does not take effect.

The `xxxxx` string in the variable name can contain only upper-case alphabetic characters, numeric characters, and periods (`.`).

You can specify a string of 1 to 64 bytes as the macro variable name.

`ejt="judgment-value-for-variable (string)";`

Specify the judgment value to be used as the judgment criterion by using a string of up to 511 bytes.

If you specify `sce`, `spe`, `sne`, or `spn` for the `ej` parameter, this parameter takes effect. If you specify another value, this parameter does not take effect.

`ej i=judgment-value-for-variable (numeric);`

Specify the judgment value to be used as the judgment criterion by using a numerical value ranging from 0 to 2,147,483,647. The default value is 0.

If you specify `vgt`, `vge`, `vlt`, `vle`, `veq`, or `vne` for the `ej` parameter, this parameter takes effect. If you specify another value, this parameter does not take effect.

`ej s=lower-limit-judgment-value-for-variable_(numeric);`

Specify a numeric value from 0 to 2,147,483,647 as the lower limit judgment value used in making a variable (numeric) judgment. If there is no integer value in the range used to judge the variable (numeric) judgment value from the lower limit judgment value (`ej s` parameter) and the boundary condition (`ej m` parameter) to the upper limit judgment value (`ej g` parameter) and the boundary condition (`ej u` parameter), an error occurs.

If you specify `vri` or `vro` for the `ej` parameter, this parameter takes effect. If you specify another value, this parameter does not take effect.

`ej g=upper-limit-judgment-value-for-variable_(numeric);`

Specify a numeric value from 0 to 2,147,483,647 as the upper limit judgment value used in making a variable (numeric) judgment. If there is no integer value in the range used to judge the variable (numeric) judgment value from the lower limit judgment value (`ej s` parameter) and the boundary condition (`ej m` parameter) to the upper limit judgment value (`ej g` parameter) and the boundary condition (`ej u` parameter), an error occurs.

If you specify `vri` or `vro` for the `ej` parameter, this parameter takes effect. If you specify another value, this parameter does not take effect.

`ej m={gt|ge};`

Define the boundary conditions used to define the lower limit judgment return code (the `ej l` parameter) or the lower limit judgment value (the `ej s` parameter) for variables (numeric). If you omit this option, the system assumes `ge`.

If you specify `ri`, `ro`, `vri`, or `vro` for the `ej` parameter, this parameter takes effect. If you specify another value, this parameter does not take effect.

- `gt`
Indicates that the return code of the preceding job or the variable judgment numeric value is greater than the judgment value.
- `ge`
Indicates that the return code of the preceding job or the variable judgment numeric value is equal to or greater than the judgment value.

`ej u={lt|le};`

Define the boundary conditions used to define the upper limit judgment return code (the `ej h` parameter) or the upper limit judgment value (the `ej g` parameter) for variables (numeric). If you omit this option, the system assumes `le`.

If you specify `ri`, `ro`, `vri`, or `vro` for the `ej` parameter, this parameter takes effect. If you specify another value, this parameter does not take effect.

- `lt`
Indicates that the return code of the preceding job or the variable judgment numeric value is smaller than the judgment value.
- `le`
Indicates that the return code of the preceding job or the variable judgment numeric value is equal to or smaller than the judgment value.

`ha={y|n};`

Define whether to suspend job execution. The default is `n`.

- y: Suspends job execution.
- n: Does not suspend job execution.

5.2.9 Job definition for monitoring JP1 event reception

This paragraph explains how to specify a job definition for monitoring JP1 event reception.

The following gives the format of, and the parameters for a job definition for monitoring JP1 event reception.

Format

```
[evwid=event-ID;]
[evusr="event-issue-source-user-name";]
[evgrp="event-issue-source-group-name";]
[evhst="event-issue-source-host-name";]
[evipa=event-issue-source-IP-address;]
[evwms="message";]
[evdet="detailed-event-information";]
[evwsv=em[:al[:cr[:er[:wr[:no[:in[:db]]]]]]];]
[evwfr=optional-extended-attribute-name:"value";]
[vtmc={n|a|n:"file-name"|a:"file-name"
      |d:"file-name"|b:"file-name"};]
[evuid=event-issue-source-user-ID;]
[evgid=event-issue-source-group-ID;]
[evpid=event-issue-source-process-ID;]
[jpoif=macro-variable-name:passing-information-name;]
[etm=n;]
[fd=time-required-for-execution;]
[ex="execution-agent-name";]
[ha={y|n};]
[eu={ent|def};]
[evesc={no|minutes};]
[ets={k|nr|wr|an};]
[mm={and|or};]
[nmg={y|n};]
[eun=name-of-the-unit-whose-end-is-being-waited-for;]
[ega={exec|execdeffer|none};]
[uem={y|n};]
```

Parameters

`evwid=event-ID;`

Define the event ID of an event to be received.

You can set hexadecimal values of 00000000:00000000 to FFFFFFFF: FFFFFFFF.

`evusr="event-issue-source-user-name";`

Define the user name of the event issue source in the basic information on an event to be received.

You can set a character string of 1 to 20 bytes.

If you want to use a double quotation mark (") or a hash mark (#) as a character, prefix the character by #. That is, use #" instead of " and use ## instead of #.

Note that you can use a regular expression to specify the user name.

`evgrp="event-issue-source-group-name";`

Define the group name of the event issue source in the basic information on an event to be received.

You can set a character string of 1 to 20 bytes.

If you want to use a double quotation mark (") or a hash mark (#) as a character, prefix the character by #. That is, use #" instead of " and use ## instead of #.

Note that you can use a regular expression to specify the group name.

```
evhst="event-issue-source-host-name";
```

Define the host name of the event issue source in the basic information about an event to be received.

You can set a character string of 1 to 255 bytes.

If you want to use a double quotation mark (") or a hash mark (#) as a character, prefix the character by #. That is, use #" instead of " and use ## instead of #.

Note that you can use a regular expression to specify the host name.

You can also specify a macro variable.

```
evipa=event-issue-source-IP-address;
```

Define the IP address of the event issue source in the basic information about an event to be received.

You can specify 0.0.0.0 to 255.255.255.255 using the *XXX.YYY.xxx.yyy* format. You can specify 0 to 255 in each of the *XXX*, *YYY*, *xxx*, and *yyy* parts.

```
evwms="message";
```

Define a character string that is to be compared with the message part of an event received.

You can set a character string of 1 to 1,024 bytes.

If you want to use a double quotation mark (") or a hash mark (#) as a character, prefix the character by #. That is, use #" instead of " and use ## instead of #.

Note that you can use a regular expression to specify the message.

```
evdet="detailed-event-information";
```

Define a character string that is to be compared with the detailed information part of an event received.

You can set a character string of 1 to 1,024 bytes.

If you want to use a double quotation mark (") or a hash mark (#) as a character, prefix the character by #. That is, use #" instead of " and use ## instead of #.

Note that you can use a regular expression to specify the detailed information.

```
evwsv=em[:al[:cr[:er[:wr[:no[:in[:db]]]]]]];
```

Define the event level of the extended attribute of an event to be received.

- *em*: Sets Emergency as the condition to be met.
- *al*: Sets Alert as the condition to be met.
- *cr*: Sets Critical as the condition to be met.
- *er*: Sets Error as the condition to be met.
- *wr*: Sets Warning as the condition to be met.
- *no*: Sets Notice as the condition to be met.
- *in*: Sets Information as the condition to be met.
- *db*: Sets Debug as the condition to be met.

```
evwfr=optional-extended-attribute-name:"value";
```

If you have set an optional attribute name or value for the extended attribute of an event to be received, define the optional extended attribute name in the format of *evwfr=optional extended attribute name:"value"*.

You can set a character string of 1 to 2,048 bytes. You can set multiple values. (You can set up to 2,048 bytes of multiple values in the format of *evwfr=optional-extended-attribute-name:"value";.*)

If you want to use a double quotation mark (") or a hash mark (#) as a character, prefix the character by #. That is, use #" instead of " and use ## instead of #.

Note that you can use regular expressions and macro variables in the optional extended attribute name.

```
evtmc={n|a|n:"file-name"|a:"file-name"|d:"file-name"|b:"file-name"};
```

Define conditions on end judgment. The default is n.

- n: Always assumes a normal end.
- a: Always assumes an abnormal end.
- n: "file-name": Normal end if the message matches the contents of a specified file
- a: "file-name": Abnormal end if the message matches the contents of a specified file
- d: "file-name": Normal end if the detailed information matches the contents of a specified file
- b: "file-name": Abnormal end if the detailed information matches the contents of a specified file

For the file name, You can set a character string of 1 to 256 bytes.

```
evuid=event-issue-source-user-ID;
```

Define the user ID of the event issue source in the basic information about an event to be received.

You can set a value of -1 to 9,999,999,999 bytes.

```
evgid=event-issue-source-group-ID;
```

Define the group ID of the event issue source in the basic information about an event to be received.

You can set a value of -1 to 9,999,999,999 bytes.

```
evpid=event-issue-source-process-ID;
```

Define the process ID of the event issue source in the basic information about an event to be received.

You can set a value of -1 to 9,999,999,999 bytes.

```
jpoif=macro-variable-name:passing-information-name;
```

Set *macro-variable-name* as a character string of no more than 64 bytes, using the format ?AJS2xxxx?. In the *xxxxx* part, you can use uppercase alphabetic characters (A to Z), numerals (0 to 9), and periods (.).

This parameter can contain up to 2,048 bytes in the "jpoif=macro-variable-name:passing-information-name;" format.

This parameter makes it possible to take over event information of subsequent Unix jobs, PC jobs, flexible jobs, HTTP connection jobs, and action jobs.

```
etm=n;
```

Define the time-out period using the relative minutes from the start time. You can set 1 to 1,440 minutes. This parameter is invalid for a job within the start condition.

```
fd=time-required-for-execution;
```

Define the time-required-for-execution within which the job is expected to be terminated.

You can specify a decimal value between 1 and 1,440 (minutes).

If you define this parameter as a start condition, it is disabled when a job is executed.

```
ex="execution-agent-name";
```

Define the name of the execution agent that is used to execute jobs.

You can set a character string of 1 to 255 bytes.

If you want to use a double quotation mark (") or a hash mark (#) as a character, prefix the character with #. That is, use #" instead of ", and use ## instead of #.

You can specify a macro variable.

ha={y|n};

Define whether to suspend job execution. The default is n. This parameter is invalid for a job within the start condition.

- y: Suspends job execution.
- n: Does not suspend job execution.

eu={ent|def};

Define the JP1 user who executes the job. The default is ent. This parameter is ignored in an event job.

- ent: The JP1 user who registered the jobnet executes the job.
- def: The JP1 user who owns the job executes the job.

evesc={no|minutes};

Define whether, immediately after the JP1 event reception monitoring job is executed (before starting monitoring for a JP1 event) any previous JP1 events still need to be monitored for reception. The default is no.

- no: Does not search for previous JP1 events.
- minutes: Searches for JP1 events that occurred from the time point earlier by the specified minutes than the time when the JP1 event reception monitoring job was executed. You can specify a decimal value between 1 and 720 (minutes).

ets={kl|nr|wr|an};

Define the state of the event job after the execution time-out period elapses. The default is kl. This parameter is invalid for a job within the start condition.

- kl: Killed
- nr: Ended normally
- wr: Ended with warning
- an: Ended abnormally

mm={and|or};

Define the wait method with respect to the specified units whose ends are being waited for. The default is and.

- and: Start executing at completion of all units whose ends are being waited for.
- or: Start executing at completion of one of the units whose ends are being waited for.

nmg={y|n};

Define the behavior when there are no generations of the root jobnet for the specified unit whose end is being waited for.

The default is n.

- y: Start executing.
- n: Do not start executing.

eun=*name-of-the-unit-whose-end-is-being-waited-for*;

Define the full-path name of a unit whose end is being waited for.

To specify multiple units, repeat the parameter. You can specify a maximum of 32 units.

You can use a character string of 1 to 930 bytes as the unit name.

```
ega={exec|execdeffer|none};
```

Specify the behavior when a jobnet with start conditions is specified as the jobnet whose end is being waited for and the execution generation ends abnormally.

If you omit this option, the system assumes none.

- `exec`: Start executing.
- `execdeffer`: Do not start executing. However, if the execution generation is in the *Skipped so not exe.* status, start executing.
- `none`: Do not start executing.

```
uem={y|n};
```

Specify the behavior when a jobnet with start conditions is specified as the jobnet whose end is being waited for and the monitoring generation is in the *Unmonitored + Ended* status.

If you omit this option, the system assumes n.

- `y`: Start executing.
- `n`: Do not start executing.

Cautionary note

Suppose that you want to pass on the information received in an event job to the parameters of a standard job or action job. If the passing information contains a double quotation mark ("), you must prefix the \ sign to the passing information. If you do not prefix the \ sign, when the received information is inherited, a problem occurs such as the double quotation mark being ignored. You can avoid this problem by setting the option that enables any data containing a double quotation mark to be considered as inheritance information.

For the specific settings, see the following appropriate sections, depending on your OS. On a Windows host, see *6.3.4 Passing event data containing double quotation marks* in the *JPI/Automatic Job Management System 3 Configuration Guide*. On a UNIX host, see *15.3.4 Passing event data containing double quotation marks* in the *JPI/Automatic Job Management System 3 Configuration Guide*.

5.2.10 File monitoring job definition

This paragraph explains how to specify a file monitoring job definition.

The following gives the format of, and the parameters for a file monitoring job definition.

Format

```
[flwf="name-of-file-to-be-monitored";]  
[flwc=c[:d[:{s|m}]]];]  
[flwi=monitoring-interval;]  
[flco={y|n};]  
[jpoif=macro-variable-name:passing-information-name;]  
[etm=n;]  
[fd=time-required-for-execution;]  
[ex="execution-agent-name";]  
[ha={y|n};]  
[eu={ent|def};]  
[ets={kl|nr|wr|an};]  
[mm={and|or};]  
[nmg={y|n};]  
[eun=name-of-the-unit-whose-end-is-being-waited-for;]
```

```
[ega={exec|execdefer|none};]  
[uem={y|n};]
```

Parameters

```
flwf="name-of-file-to-be-monitored";
```

Define the name of a file to be monitored.

You can set a character string of 1 to 255 bytes. You can specify a full-path file name or wildcard characters using the wildcard (*). However, you cannot use the wildcard for wildcard characters when you specify 1 to 9 as the monitor interval in the `flwi` parameter.

If you want to use a double quotation mark (") or a hash mark (#) as a character, prefix the character by #. That is, use #" instead of " and use ## instead of #.

To specify a file over a network, use a UNC path to specify the file name. You cannot specify a path that begins with a network drive name.

You can specify a macro variable.

```
flwc=c[:d[:{s|m}]];
```

Define the monitoring conditions. You can specify multiple items. However, you cannot specify `s` together with `m`. The default is `c`.

- `c`: Monitors file creation.
- `d`: Monitors file deletion.
- `s`: Monitors file resizing.
- `m`: Monitors for a change in the writing time of the last file.

```
flwi=monitoring-interval;
```

Define a time interval to monitor a file.

You can set 1 to 600 (seconds). However you cannot use the wildcard for wildcard characters when you specify a value of 1 to 9 as the monitor interval in the `flwi` parameter. The default is 60.

```
flco={y|n};
```

Defines whether or not to make monitor conditions true if `c` is specified in the `flwc` parameter and if the file to be monitored exists when the file monitoring job is executed. You can specify this parameter only when `c` is specified in the `flwc` parameter. The default is `n`.

- `y`: Makes the monitor conditions true, thus terminating the job normally.
- `n`: Monitors how a monitor target file is created after the file monitoring job is executed.

```
jpouif=macro-variable-name:passing-information-name;
```

Set *macro-variable-name* as a character string of no more than 64 bytes, using the format `?AJS2xxxxx?`. In the `xxxxx` part, you can use uppercase alphabetic characters (A to Z), numerals (0 to 9), and periods (.).

This parameter can contain up to 2,048 bytes in the `"jpouif=macro-variable-name:passing-information-name;"` format.

This parameter makes it possible to take over event information of subsequent Unix jobs, PC jobs, flexible jobs, HTTP connection jobs, and action jobs.

```
etm=n;
```

Define the time-out period using the relative minutes from the start time. You can set 1 to 1,440 minutes. This parameter is invalid for a job within the start condition.

```
fd=time-required-for-execution;
```

Define the time-required-for-execution within which the job is expected to be terminated.

You can specify a decimal value between 1 and 1,440 (minutes).

If you define this parameter as a start condition, it is disabled when a job is executed.

```
ex="execution-agent-name";
```

Define the name of the execution agent that is used to execute jobs.

You can set a character string of 1 to 255 bytes.

If you want to use a double quotation mark (") or a hash mark (#) as a character, prefix the character with #. That is, use #" instead of ", and use ## instead of #.

You can specify a macro variable.

```
ha={y|n};
```

Define whether to suspend job execution. The default is n. This parameter is invalid for a job within the start condition.

- y: Suspends job execution.
- n: Does not suspend job execution.

```
eu={ent|def};
```

Define the JP1 user who executes the job. The default is ent. This parameter is ignored in an event job.

- ent: The JP1 user who registered the jobnet executes the job.
- def: The JP1 user who owns the job executes the job.

```
ets={kl|nr|wr|an};
```

Define the state of the event job after the execution time-out period elapses. The default is kl. This parameter is invalid for a job within the start condition.

- kl: Killed
- nr: Ended normally
- wr: Ended with warning
- an: Ended abnormally

```
mm={and|or};
```

Define the wait method with respect to the specified units whose ends are being waited for.

The default is and.

- and: Start executing at completion of all units whose ends are being waited for.
- or: Start executing at completion of one of the units whose ends are being waited for.

```
nmg={and|or};
```

Define the behavior when there are no generations of the root jobnet for the specified unit whose end is being waited for.

The default is n.

- y: Start executing.
- n: Do not start executing.

```
eun=name-of-the-unit-whose-end-is-being-waited-for;
```

Define the full-path name of a unit whose end is being waited for.

To specify multiple units, repeat the parameter. You can specify a maximum of 32 units.

You can use a character string of 1 to 930 bytes as the unit name.

```
ega={exec|execdeffer|none};
```

Specify the behavior when a jobnet with start conditions is specified as the jobnet whose end is being waited for and the execution generation ends abnormally.

If you omit this option, the system assumes none.

- `exec`: Start executing.
- `execdeffer`: Do not start executing. However, if the execution generation is in the *Skipped so not exe.* status, start executing.
- `none`: Do not start executing.

```
uem={y|n};
```

Specify the behavior when a jobnet with start conditions is specified as the jobnet whose end is being waited for and the monitoring generation is in the *Unmonitored + Ended* status.

If you omit this option, the system assumes n.

- `y`: Start executing.
- `n`: Do not start executing.

5.2.11 Email reception monitoring job definition

This paragraph explains how to specify an email reception monitoring job definition.

The following gives the format of, and the parameters for an email reception monitoring job definition.

Format

```
[pfm={u|p};]
[mlprf="profile-name";]
[mladr="sender";]
[mlsbj="subject";]
[mltx="text";]
[mlsav={y|n};]
[mllst="received-email-list";]
[mlstx="name-of-text-file";]
[mlsfd="name-of-folder-to-save-attached-file";]
[mlafl="name-of-list-file";]
[jpoif=macro-variable-name:passing-information-name;]
[etm=n;]
[fd=time-required-for-execution;]
[ex="execution-agent-name";]
[ha={y|n};]
[eu={ent|def};]
[ets={kl|nr|wr|an};]
[mm={and|or};]
[nmg={y|n};]
[eun=name-of-the-unit-whose-end-is-being-waited-for;]
[ega={exec|execdeffer|none};]
[uem={y|n};]
```

Parameters

```
pfm={u|p};
```

Specify email reception definitions for each platform. The default is p.

- p: Provides definitions for email reception in the Windows environment.
- u: Provides definitions for email reception in the UNIX environment.

`mlprf="profile-name";`

Specify one of the profile names set in the `ProfileName1` to `ProfileName4` environment setting parameters on the agent host on which the email reception monitoring job is executed.

This parameter is valid only if you specify `pfm=p`; . Note also that this is a required parameter if you specify `pfm=p`;

You can set a character string of 1 to 256 bytes.

If you want to use a double quotation mark (") or a hash mark (#) as a character, prefix the character by #. That is, use # " instead of " and use ## instead of #.

For details about the environment setting parameters, see *2.3.4 Setting up the environment for the mail system linkage* in the *JP1/Automatic Job Management System 3 Linkage Guide*.

`mladr="sender";`

Define the sender of email.

You can set a character string of 1 to 256 bytes. You can specify up to 20 sender names at the same time in the format of `mladr="sender";` .

You cannot omit all of `mladr="sender";` , `mlsbj="subject";` and `mltxt="text";` . You must define at least one of the items.

If you want to use a double quotation mark (") or a hash mark (#) in the sender, prefix the character by #. That is, use # " instead of " and use ## instead of #.

If the host that executes the email reception monitoring job is a Windows host, specify no more than 255 characters for the sender. You can specify 256 bytes or fewer for the sender; however, if you specify 256 or more characters, the monitoring conditions for email reception will not be satisfied.

`mlsbj="subject";`

Define the subject of received email.

You can set a character string of 1 to 256 bytes. You can specify up to 20 subjects at the same time in the format of `mlsbj="subject";` .

You cannot specify all of `mladr="sender";` , `mlsbj="subject";` and `mltxt="text";` . You must define at least one of the items.

If you want to use a double quotation mark (") or a hash mark (#) as a character, prefix the character by #. That is, use # " instead of " and use ## instead of #.

If the host that executes the email reception monitoring job is a Windows host, specify no more than 253 characters for the subject. You can specify 256 or fewer bytes for the subject; however, if you specify 254 or more characters, the monitoring conditions for email reception will not be satisfied.

`mltxt="text";`

Define the text of received email.

You can set a character string of 1 to 512 bytes. You can specify up to 20 messages at the same time in the format of `mltxt="text";` .

You cannot specify all of `mladr="sender";` , `mlsbj="subject";` and `mltxt="text";` . You must define at least one of the items.

If you want to use a double quotation mark (") or a hash mark (#) as a character, prefix the character by #. That is, use # " instead of " and use ## instead of #.

If a UNIX host performs email reception monitoring, do not enter a line feed in the text. The text containing a line feed becomes inconsistent with the email monitoring conditions, causing the system to remain in the email monitoring status.

`mlsav={y|n};`

Define whether to save received emails. The default is `y`. This parameter is valid only when you specify `pfm=u`;

- `y`: Saves emails.
- `n`: Does not save emails.

`mlst="received-email-list";`

When creating a list of emails which match monitoring conditions, define a received-email list name. This parameter is valid only when you specify `pfm=u`;

You can set a character string of 1 to 255 bytes.

If you want to use a double quotation mark (") or a hash mark (#) as a character, prefix the character by #. That is, use #`"` instead of `"` and use ## instead of #.

`mlstx="text-file-name";`

When saving received email text in a file, specify a file name. This parameter is valid only when you specify `pfm=p`;

You can set a character string of 1 to 256 bytes. Specify a full-path file name.

If you want to use a double quotation mark (") or a hash mark (#) as a character, prefix the character by #. That is, use #`"` instead of `"` and use ## instead of #.

`mlsfd="name-of-folder-to-save-attached-file";`

Define the folder name of a folder to save the attached file of received email. This parameter is valid only when you specify `pfm=p`;

You can set a character string of 1 to 256 bytes. Specify a full-path folder name.

If you want to use a double quotation mark (") or a hash mark (#) as a character, prefix the character by #. That is, use #`"` instead of `"` and use ## instead of #.

`mlafl="list-file-name";`

Define the file name of a file to list the received attached file names for received email. This parameter is valid only when you specify `pfm=p`;

You can set a character string of 1 to 256 bytes. Specify a full-path file name.

If you want to use a double quotation mark (") or a hash mark (#) as a character, prefix the character by #. That is, use #`"` instead of `"` and use ## instead of #.

`jpoif=macro-variable-name:passing-information-name;`

Set *macro-variable-name* as a character string of no more than 64 bytes, using the format `?AJS2xxxx?`. In the `xxxx` part, you can use uppercase alphabetic characters (A to Z), numerals (0 to 9), and periods (.).

This parameter can contain up to 2,048 bytes in the `"jpoif=macro-variable-name:passing-information-name;"` format.

This parameter makes it possible to take over event information of subsequent Unix jobs, PC jobs, flexible jobs, HTTP connection jobs, and action jobs.

`etm=n;`

Define the time-out period using the relative minutes from the start time. You can set 1 to 1,440 minutes. This parameter is invalid for a job within the start condition.

`fd=time-required-for-execution;`

Define the time-required-for-execution within which the job is expected to be terminated.

You can specify a decimal value between 1 and 1,440 (minutes).

If you define this parameter as a start condition, it is disabled when a job is executed.

`ex="execution-agent-name";`

Define the name of the execution agent that is used to execute jobs.

You can set a character string of 1 to 255 bytes.

If you want to use a double quotation mark (") or a hash mark (#) as a character, prefix the character with #. That is, use #" instead of ", and use ## instead of #.

You can specify a macro variable.

`ha={y|n};`

Define whether to suspend job execution. The default is `n`. This parameter is invalid for a job within the start condition.

- `y`: Suspends job execution.
- `n`: Does not suspend job execution.

`eu={ent|def};`

Define the JP1 user who executes the job. The default is `ent`. This parameter is ignored in an event job.

- `ent`: The JP1 user who registered the jobnet executes the job.
- `def`: The JP1 user who owns the job executes the job.

`ets={kl|nr|wr|an};`

Define the state of the event job after the execution time-out period elapses. The default is `kl`. This parameter is invalid for a job within the start condition.

- `kl`: Killed
- `nr`: Ended normally
- `wr`: Ended with warning
- `an`: Ended abnormally

`mm={and|or};`

Define the wait method with respect to the specified units whose ends are being waited for.

The default is `and`.

- `and`: Start executing at completion of all units whose ends are being waited for.
- `or`: Start executing at completion of one of the units whose ends are being waited for.

`nmg={y|n};`

Define the behavior when there are no generations of the root jobnet for the specified unit whose end is being waited for.

The default is `n`.

- `y`: Start executing.
- `n`: Do not start executing.

`eun=name-of-the-unit-whose-end-is-being-waited-for;`

Define the full-path name of a unit whose end is being waited for.

To specify multiple units, repeat the parameter. You can specify a maximum of 32 units.

You can use a character string of 1 to 930 bytes as the unit name.

`ega={exec|execdefer|none};`

Specify the behavior when a jobnet with start conditions is specified as the jobnet whose end is being waited for and the execution generation ends abnormally.

If you omit this option, the system assumes none.

- `exec`: Start executing.
- `execdefer`: Do not start executing. However, if the execution generation is in the *Skipped so not exe.* status, start executing.
- `none`: Do not start executing.

`uem={y|n};`

Specify the behavior when a jobnet with start conditions is specified as the jobnet whose end is being waited for and the monitoring generation is in the *Unmonitored + Ended* status.

If you omit this option, the system assumes n.

- `y`: Start executing.
- `n`: Do not start executing.

5.2.12 Job definition for monitoring message-queue message reception

This paragraph explains how to specify a job definition for monitoring reception of messages sent from a message queue.

The following gives the format of, and the parameters for a message-queue message reception monitoring job definition.

Format

```
[mqcor=correlation-ID];
[mqqe=message-input-queue-name];
[mqdsc=message-ID];
[mqmdl=model-queue-name];
[mqsfm="message-storage-file-name";]
[jpoif=macro-variable-name:passing-information-name];
[etm=n];
[fd=time-required-for-execution];
[ex="execution-agent-name";]
[ha={y|n};]
[eu={ent|def};]
[ets={k|nr|wr|an};]
[mm={and|or};]
[nmg={y|n};]
[eun=name-of-the-unit-whose-end-is-being-waited-for];
[ega={exec|execdefer|none};]
[uem={y|n};]
```

Parameters

`mqcor=correlation-ID;`

Define the correlation ID of a received message.

You can set a character string of 1 to 24 bytes. You can, however, set only uppercase alphanumeric characters.

`mqqe=message-input-queue-name;`

Define the queue name of a queue to monitor message reception.

You can set a character string of 1 to 48 bytes. Specify a queue name using an MQ character string. When linking MQSeries, specify the name of a queue that exists in the default queue manager.

`mqdsc=message-ID;`

Define the message ID of a received message.

You can set a character string of 1 to 24 bytes. You can, however, specify only uppercase alphanumeric characters.

`mqmdl=model-queue-name;`

Define the model queue name of a queue to monitor message reception.

You can set a character string of 1 to 48 bytes. Specify a queue name using an MQ character string. When linking MQSeries, specify the name of a queue that exists in the default queue manager.

`mqsfm="message-storage-file-name";`

Define the name of a file that stores messages matching monitoring conditions.

You can set a character string of 1 to 256 bytes. The file name must be the full path file name.

If you want to use a double quotation mark (") or a hash mark (#) as a character, prefix the character by #. That is, use #" instead of " and use ## instead of #.

`jpouif=macro-variable-name:passing-information-name;`

Set *macro-variable-name* as a character string of no more than 64 bytes, using the format ?AJS2xxxx?. In the *xxxxx* part, you can use uppercase alphabetic characters (A to Z), numerals (0 to 9), and periods (.).

This parameter can contain up to 2,048 bytes in the "jpouif=macro-variable-name:passing-information-name;".

This parameter makes it possible to take over event information of subsequent Unix jobs, PC jobs, flexible jobs, HTTP connection jobs, and action jobs.

`etm=n;`

Define the time-out period using the relative minutes from the start time. You can set 1 to 1,440 minutes. This parameter is invalid for a job within the start condition.

`fd=time-required-for-execution;`

Define the time-required-for-execution within which the job is expected to be terminated.

You can specify a decimal value between 1 and 1,440 (minutes).

If you define this parameter as a start condition, it is disabled when a job is executed.

`ex="execution-agent-name";`

Define the name of the execution agent that is used to execute jobs.

You can set a character string of 1 to 255 bytes.

If you want to use a double quotation mark (") or a hash mark (#) as a character, prefix the character with #. That is, use #" instead of ", and use ## instead of #.

`ha={y|n};`

Define whether to suspend job execution. The default is n. This parameter is invalid for a job within the start condition.

- y: Suspends job execution.
- n: Does not suspend job execution.

`eu={ent|def};`

Define the JP1 user who executes the job. The default is ent. This parameter is ignored in an event job.

- ent: The JP1 user who registered the jobnet executes the job.
- def: The JP1 user who owns the job executes the job.

`ets={kl|nr|wr|an};`

Define the state of the event job after the execution time-out period elapses. The default is kl. This parameter is invalid for a job within the start condition.

- kl: Killed

- `nr`: Ended normally
- `wr`: Ended with warning
- `an`: Ended abnormally

`mm={and|or};`

Define the wait method with respect to the specified units whose ends are being waited for. The default is `and`.

- `and`: Start executing at completion of all units whose ends are being waited for.
- `or`: Start executing at completion of one of the units whose ends are being waited for.

`nmg={y|n};`

Define the behavior when there are no generations of the root jobnet for the specified unit whose end is being waited for.

The default is `n`.

- `y`: Start executing.
- `n`: Do not start executing.

`eun=name-of-the-unit-whose-end-is-being-waited-for;`

Define the full-path name of a unit whose end is being waited for.

To specify multiple units, repeat the parameter. You can specify a maximum of 32 units.

You can use a character string of 1 to 930 bytes as the unit name.

`ega={exec|execdefer|none};`

Specify the behavior when a jobnet with start conditions is specified as the jobnet whose end is being waited for and the execution generation ends abnormally.

If you omit this option, the system assumes `none`.

- `exec`: Start executing.
- `execdefer`: Do not start executing. However, if the execution generation is in the *Skipped so not exe* status, start executing.
- `none`: Do not start executing.

`uem={y|n};`

Specify the behavior when a jobnet with start conditions is specified as the jobnet whose end is being waited for and the monitoring generation is in the *Unmonitored + Ended* status.

If you omit this option, the system assumes `n`.

- `y`: Start executing.
- `n`: Do not start executing.

5.2.13 MSMQ message reception monitoring job definition

This paragraph explains how to specify a job definition for monitoring MSMQ message reception.

The following gives the format of, and the parameters for an MSMQ message reception monitoring job definition.

Format

```
[msqpt="path-name";]  
[msrer=correlation-ID;]  
[mslbl="message-label";]  
[msapl=application-information;]  
[mssvf="message-storage-file-name";]  
[jpoif=macro-variable-name:passing-information-name;]  
[etm=n;]  
[fd=time-required-for-execution;]  
[ex="execution-agent-name";]  
[ha={y|n};]  
[eu={ent|def};]  
[ets={k|nr|wr|an};]  
[mm={and|or};]  
[nmg={y|n};]  
[eun=name-of-the-unit-whose-end-is-being-waited-for;]  
[ega={exec|execdeffer|none};]  
[uem={y|n};]
```

Parameters

`msqpt="path-name";`

Define the queue path name of a queue to monitor messages.

You can set a character string of 1 to 259 bytes.

If you want to use a double quotation mark (") or a hash mark (#) as a character, prefix the character by #. That is, use #" instead of " and use ## instead of #.

`msrer=correlation-ID;`

Define the correlation ID of a message to be monitored.

You can set a character string of 1 to 20 bytes. Note that you can specify only uppercase alphabetic and numeric characters.

`mslbl="message-label";`

Define the message label of a message to be monitored.

You can set a character string of 1 to 249 bytes.

If you want to use a double quotation mark (") or a hash mark (#) as a character, prefix the character by #. That is, use #" instead of " and use ## instead of #.

`msapl=application-information;`

Define application information about a message to be monitored.

You can specify any hexadecimal value ranging from 0 to FFFFFFFF.

`mssvf="message-storage-file-name";`

Define the name of a file that stores messages matching monitoring conditions.

You can set a character string of 1 to 256 bytes. Specify a full-path file name.

If you want to use a double quotation mark (") or a hash mark (#) as a character, prefix the character by #. That is, use #" instead of " and use ## instead of #.

`jpoif=macro-variable-name:passing-information-name;`

Set *macro-variable-name* as a character string of no more than 64 bytes, using the format ?AJS2xxxx?. In the *xxxx* part, you can use uppercase alphabetic characters (A to Z), numerals (0 to 9), and periods (.).

This parameter can contain up to 2,048 bytes in the "jpoif=macro-variable-name:passing-information-name;".

This parameter makes it possible to take over event information of subsequent Unix jobs, PC jobs, flexible jobs, HTTP connection jobs, and action jobs.

`etm=n;`

Define the time-out period using the relative minutes from the start time. You can set 1 to 1,440 minutes. This parameter is invalid for a job within the start condition.

`fd=time-required-for-execution;`

Define the time-required-for-execution within which the job is expected to be terminated.

You can specify a decimal value between 1 and 1,440 (minutes).

If you define this parameter as a start condition, it is disabled when a job is executed.

`ex="execution-agent-name";`

Define the name of the execution agent that is used to execute jobs.

You can set a character string of 1 to 255 bytes.

If you want to use a double quotation mark (") or a hash mark (#) as a character, prefix the character with #. That is, use # " instead of ", and use ## instead of #.

`ha={y|n};`

Define whether to suspend job execution. The default is n. This parameter is invalid for a job within the start condition.

- y: Suspends job execution.
- n: Does not suspend job execution.

`eu={ent|def};`

Define the JP1 user who executes the job. The default is ent. This parameter is ignored in an event job.

- ent: The JP1 user who registered the jobnet executes the job.
- def: The JP1 user who owns the job executes the job.

`ets={kl|nr|wr|an};`

Define the state of the event job after the execution time-out period elapses. The default is kl. This parameter is invalid for a job within the start condition.

- kl: Killed
- nr: Ended normally
- wr: Ended with warning
- an: Ended abnormally

`mm={and|or};`

Define the wait method with respect to the specified units whose ends are being waited for.

The default is and.

- and: Start executing at completion of all units whose ends are being waited for.
- or: Start executing at completion of one of the units whose ends are being waited for.

`nmg={y|n};`

Define the behavior when there are no generations of the root jobnet for the specified unit whose end is being waited for.

The default is n.

- y: Start executing.

- n: Do not start executing.

eun=*name-of-the-unit-whose-end-is-being-waited-for*;

Define the full-path name of a unit whose end is being waited for.

To specify multiple units, repeat the parameter. You can specify a maximum of 32 units.

You can use a character string of 1 to 930 bytes as the unit name.

ega={exec|execdeffer|none};

Specify the behavior when a jobnet with start conditions is specified as the jobnet whose end is being waited for and the execution generation ends abnormally.

If you omit this option, the system assumes none.

- exec: Start executing.
- execdeffer: Do not start executing. However, if the execution generation is in the *Skipped so not exe.* status, start executing.
- none: Do not start executing.

uem={y|n};

Specify the behavior when a jobnet with start conditions is specified as the jobnet whose end is being waited for and the monitoring generation is in the *Unmonitored + Ended* status.

If you omit this option, the system assumes n.

- y: Start executing.
- n: Do not start executing.

5.2.14 Log-file monitoring job definition

This paragraph explains how to specify a log-file monitoring job definition.

The following gives the format of and the parameters for a log-file monitoring job definition.

Format

```
[lftpd={!}"trap-data-1"[:{!}"trap-data-2"...];]...
[lffnm="log-file-name";]
[lfdft={s|s2|w1|w2};]
[lfrft={v:'[\] delimiter'|f:record-length};]
[lfhds={l:header-row-count|s:header-size};]
[lfmks={!}"data-1-other-than-log-information"
[: {!}"data-2-other-than-log-information"...];]
[lfsiv=file-monitoring-interval;]
[lfmxl=maximum-event-data-length;]
[lfsrc={y|n};]
[lfcre={y|n};]
[jpoif=macro-variable-name:passing-information-name;]
[etm=n;]
[fd=time-required-for-execution;]
[ex="execution-agent-name";]
[ha={y|n};]
[eu={ent|def};]
[ets={k|nr|wr|an};]
[mm={and|or};]
[nmg={y|n};]
```

```
[eun=name-of-the-unit-whose-end-is-being-waited-for];  
[ega={exec|execdeffer|none};]  
[uem={y|n};]
```

Parameters

```
lftpd=[!] "trap-data-1" [: [!] "trap-data-2" ...];
```

Define data in a log file to be trapped.

You can set multiple pieces of trap data in a single `lftpd` parameter (based on AND conditions). You can also set more than one `lftpd` parameter (based on OR conditions). You can set up to 2,048 bytes of pieces of data.

If you want to use a double quotation mark (") or a hash mark (#) as a character, prefix the character by #. That is, use # " instead of " and use ## instead of #.

Note that you can use a regular expression to specify trap data.

```
lffnm="log-file-name";
```

Specify the file name that is to be monitored.

You can set a character string of 1 to 256 bytes. You can set up to eight log file names at one time in the format of `lffnm="log-file-name"`.

If you want to use a double quotation mark (") or a hash mark (#) as a character, prefix the character by #. That is, use # " instead of " and use ## instead of #.

You can specify a macro variable.

```
lfdft={s|s2|w1|w2};
```

Define the output format of a log file to be trapped. The default is `s`.

- `s`: Sequential file (Data is appended to one log file, and when the file is filled to its capacity, a new log file is created with another name, and new log data is written to the new file.)
- `s2`: Sequential file (A log file with the same name is continuously used for logging by creating a new file with the same name after backing up the current file with another name or deleting the current file.)

If the job execution host is a Windows host, you can specify this option in JP1/AJS3, or in JP1/AJS2 08-00 or a later version if the JP1/Base version is 08-10 or later.

If the job execution host is a UNIX host, you can specify this option in JP1/AJS3, or in JP1/AJS2 07-00 or a later version if the JP1/Base version is 07-00 or later.

- `w1`: Wraparound (When log data is written to the end of the log file, the existing data is overwritten with new data, starting with the beginning of the file.)
- `w2`: Wraparound (When log data is written to the end of the log file, the existing data is deleted and then new data is written from the beginning of the file.)

```
lfrft={v: '[\ ] delimiter' | f: record-format};
```

Define a record format for log data to be trapped. The default is `v: '\n'`.

- `v: '[\] delimiter'`: Delimits rows by a variable-length record. You can set a character string of 1 byte for a delimiter.
- `f: record-length`: Delimits rows by a fixed-length record. You can set a character string of 1 to 9,999,999 bytes for record length.

```
lfhds={l: header-row-count | s: header-size};
```

Define a header.

- `l: header-row-count`: If the log file to be trapped begins with a header, specify the number of header rows. You can set 0 to 99,999 header rows.

- *s* : *header-size*: Specify a header size if the log file to be trapped begins with a header for which you cannot specify a row count. For example, you cannot specify a row count if the format of binary data or records is different from that of a log record.

You can set 0 to 9,999,999 bytes for a header size.

```
lfmks=[ ! ] "data-1-other-than-log-information" [ : [ ! ] "data-2-other-than-log-information" . . . ] ;
```

If the log file to be trapped contains data other than log information, define the data.

You can set up to 1,024 bytes of multiple data items.

If you want to use a double quotation mark (") or a hash mark (#) as a character, prefix the character by #. That is, use #" instead of " and use ## instead of #.

Note that you can use a regular expression to specify data.

OR conditions apply if you specify more than one *lfmks* parameter, while AND conditions apply if you specify more than one item of data in a single *lfmks* parameter.

```
lfsiv=file-monitoring-interval;
```

Define a time interval to search the log file.

You can set 1 to 86,400 seconds. The default is 10.

```
lfmxl=maximum-event-log-data-length;
```

Define how many top bytes are to be set as event data in one row in a specified log file to be entered.

You can set 2 to 512 bytes. The default is 512.

```
lfsrc={y|n} ;
```

Define whether to enter data from its top. The default is *n*.

- *y*: Enters data from its top.
- *n*: Does not enter data from its top.

```
lfcrc={y|n} ;
```

Define whether to cause an error if a specified log file is missing when you have started a log file monitoring job. The default is *n*.

- *y*: Error
- *n*: Opens the file repeatedly until the log file is created.

```
jpoif=macro-variable-name : passing-information-name ;
```

Set *macro-variable-name* as a character string of no more than 64 bytes, using the format ?AJS2xxxx?. In the *xxxx* part, you can use uppercase alphabetic characters (A to Z), numerals (0 to 9), and periods (.).

This parameter can contain up to 2,048 bytes in the "*jpoif=macro-variable-name* : *passing-information-name* ;".

This parameter makes it possible to take over event information of subsequent PC jobs, Unix jobs, flexible jobs, HTTP connection jobs, and action jobs.

```
etm=n ;
```

Define the time-out period using the relative minutes from the start time. You can set 1 to 1,440 minutes. This parameter is invalid for a job within the start condition.

```
fd=time-required-for-execution ;
```

Define the time-required-for-execution within which the job is expected to be terminated.

You can specify a decimal value between 1 and 1,440 (minutes).

If you define this parameter as a start condition, it is disabled when a job is executed.

`ex="execution-agent-name";`

Define the name of the execution agent that is used to execute jobs.

You can set a character string of 1 to 255 bytes.

If you want to use a double quotation mark (") or a hash mark (#) as a character, prefix the character with #. That is, use #" instead of ", and use ## instead of #.

You can specify a macro variable.

`ha={y|n};`

Define whether to suspend job execution. The default is `n`. This parameter is invalid for a job within the start condition.

- `y`: Suspends job execution.
- `n`: Does not suspend job execution.

`eu={ent|def};`

Define the JP1 user who executes the job. The default is `ent`. This parameter is ignored in an event job.

- `ent`: The JP1 user who registered the jobnet executes the job.
- `def`: The JP1 user who owns the job executes the job.

`ets={kl|nr|wr|an};`

Define the state of the event job after the execution time-out period elapses. The default is `kl`. This parameter is invalid for a job within the start condition.

- `kl`: Killed
- `nr`: Ended normally
- `wr`: Ended with warning
- `an`: Ended abnormally

`mm={and|or};`

Define the wait method with respect to the specified units whose ends are being waited for.

The default is `and`.

- `and`: Start executing at completion of all units whose ends are being waited for.
- `or`: Start executing at completion of one of the units whose ends are being waited for.

`nmg={y|n};`

Define the behavior when there are no generations of the root jobnet for the specified unit whose end is being waited for.

The default is `n`.

- `y`: Start executing.
- `n`: Do not start executing.

`eun=name-of-the-unit-whose-end-is-being-waited-for;`

Define the full-path name of a unit whose end is being waited for.

To specify multiple units, repeat the parameter. You can specify a maximum of 32 units.

You can use a character string of 1 to 930 bytes as the unit name.

`ega={exec|execdefer|none};`

Specify the behavior when a jobnet with start conditions is specified as the jobnet whose end is being waited for and the execution generation ends abnormally.

If you omit this option, the system assumes `none`.

- `exec`: Start executing.
- `execdefer`: Do not start executing. However, if the execution generation is in the *Skipped so not exe.* status, start executing.
- `none`: Do not start executing.

`uem={y|n};`

Specify the behavior when a jobnet with start conditions is specified as the jobnet whose end is being waited for and the monitoring generation is in the *Unmonitored + Ended* status.

If you omit this option, the system assumes `n`.

- `y`: Start executing.
- `n`: Do not start executing.

Cautionary notes

- The log file name can also contain space characters and symbols. However, if you want to use a special character, such as a double quotation mark (`"`), as a normal character, prefix a backslash (`\`) to the special character.

For example: `log\#"file`

- Suppose that you want to pass on (inherit) the passing information received in an event job to the parameters of a standard job or action job. If the passing information contains a double quotation mark (`"`), you must prefix the `\` sign to the passing information. If you do not prefix the `\` sign, even if the received information is inherited, a problem occurs: for example, the double quotation mark is ignored. You can avoid this problem by setting the option that enables any data containing a double quotation mark to serve as passing information as specified.

For the specific settings, see the following sections, depending on your OS. On a Windows host, see *6.3.4 Passing event data containing double quotation marks* in the *JPI/Automatic Job Management System 3 Configuration Guide*. On a UNIX host, see *15.3.4 Passing event data containing double quotation marks* in the *JPI/Automatic Job Management System 3 Configuration Guide*.

5.2.15 Windows event-log monitoring job definition

This paragraph explains how to specify a definition for a Windows event-log monitoring job.

The following gives the format of, and the parameters for a Windows event-log monitoring job definition.

Format

```
[ntlgt={sys|sec|app|dns|dir|frs|oth};]
[ntolg="any-log-type";]
[ntevt=[v[: i[: w[: e[: s[: c[: f]]]]]]];]
[ntnsr={y|n};]
[ntsrc="source";]
[ntncl={y|n};]
[ntcls="class";]
[ntnei={y|n};]
[nteid=event-ID;]
[ntdis="explanation";]
[jpoif=macro-variable-name:passing-information-name;]
[etm=n;]
[fd=time-required-for-execution;]
[ex="execution-agent-name";]
[ha={y|n};]
```

```
[eu={ent|def};]
[ets={kl|nr|wr|an};]
[mm={and|or};]
[nmg={y|n};]
[eun=name-of-the-unit-whose-end-is-being-waited-for;]
[ega={exec|execdeffer|none};]
[uem={y|n};]
```

Parameters

```
ntlgt={sys|sec|app|dns|dir|frs|oth};
```

Define a log type. The default is `sys`.

- `sys`: Monitors a system log.
- `sec`: Monitors a security log.
- `app`: Monitors an application log.
- `dns`: Monitors the DNS Server log.#
- `dir`: Monitors the Directory Service log.#
- `frs`: Monitors the file reproduction service log.#
- `oth`: Monitors the log type specified as the any log type. You must specify the `ntolg` parameter together with this parameter.

#

This type can be defined only for Windows 2000.

```
ntolg="any-log-type";
```

Define the any log type to be monitored.

The number of characters you can specify is from 1 to 255 (bytes).

If you want to use a double quotation mark (") or a hash mark (#) as a character, prefix the character with #. That is, use #" instead of " and use ## instead of #.

If you specify `oth` for the `ntlgt` parameter, but do not specify this parameter, an error occurs. If you specify a value other than `oth` for the `ntlgt` parameter, and specify this parameter, an error occurs.

```
ntevt=[v[:i[:w[:e[:c[:s[:f]]]]]]];
```

Define an event type. By default, all the types are assumed.

- `v`: Monitors a verbose event.
- `i`: Monitors an information event.
- `w`: Monitors a warning event.
- `e`: Monitors an error event.
- `c`: Monitors a critical event.
- `s`: Monitors a success audit event.
- `f`: Monitors a failure audit event.

```
ntnsr={y|n};
```

Define judgment conditions for a source to be monitored. The default is `y`.

- `y`: Monitors a specified source.
- `n`: Monitored the sources other than a specified one. This is equivalent to NOT.

```
ntsrc="source";
```

Define a source to be monitored.

You can set a character string of 1 to 255 bytes.

If you want to use a double quotation mark (") or a hash mark (#) as a character, prefix the character by #. That is, use #" instead of " and use ## instead of #.

```
ntncl={y|n};
```

Defines judgment conditions for an event class to be monitored. The default is y.

- y: Monitors a specified class.
- n: Monitors the classes other than a specified one. This is equivalent to NOT.

```
ntcls="class";
```

Define an event class to be monitored.

You can set a character string of 1 to 255 bytes.

If the system cannot identify the class of a Windows event, the Windows event viewer displays Others. If you want to monitor such an unclassified event, specify None instead of Others. Even if you specify a character string of Others, no monitoring conditions are applied.

```
ntnei={y|n};
```

Define judgment conditions for an event ID to be monitored. The default is y.

- y: Monitors a specified event ID.
- n: Monitors the IDs other than a specified event ID.

```
nteid=event-ID;
```

Define the event ID of an event to be monitored.

You can set 0 to 4,294,967,295.

```
ntdis="explanation";
```

To monitor the explanation of a specified event, define a character string for comparison.

You can set a character string of 1 to 1,024 bytes.

If you want to use a double quotation mark (") or a hash mark (#) as a character, prefix the character by #. That is, use #" instead of " and use ## instead of #.

Note that you can use a regular expression to specify the explanation.

```
jpouif=macro-variable-name:passing-information-name;
```

Set *macro-variable-name* as a character string of no more than 64 bytes, using the format ?AJS2xxxx?. In the *xxxxx* part, you can use uppercase alphabetic characters (A to Z), numerals (0 to 9), and periods (.).

This parameter can contain up to 2,048 bytes in the "*jpouif=macro-variable-name:passing-information-name*";".

This parameter makes it possible to take over event information of subsequent Unix jobs, PC jobs, flexible jobs, HTTP connection jobs, and action jobs.

```
etm=n;
```

Define the time-out period using the relative minutes from the start time. You can set 1 to 1,440 minutes. This parameter is invalid for a job within the start condition.

```
fd=time-required-for-execution;
```

Define the time-required-for-execution within which the job is expected to be terminated.

You can specify a decimal value between 1 and 1,440 (minutes).

If you define this parameter as a start condition, it is disabled when a job is executed.

`ex="execution-agent-name";`

Define the name of the execution agent that is used to execute jobs.

You can set a character string of 1 to 255 bytes.

If you want to use a double quotation mark (") or a hash mark (#) as a character, prefix the character with #. That is, use #" instead of ", and use ## instead of #.

You can specify a macro variable.

`ha={y|n};`

Define whether to suspend job execution. The default is `n`. This parameter is invalid for a job within the start condition.

- `y`: Suspends job execution.
- `n`: Does not suspend job execution.

`eu={ent|def};`

Define the JP1 user who executes the job. The default is `ent`. This parameter is ignored in an event job.

- `ent`: The JP1 user who registered the jobnet executes the job.
- `def`: The JP1 user who owns the job executes the job.

`ets={kl|nr|wr|an};`

Define the state of the event job after the execution time-out period elapses. The default is `kl`. This parameter is invalid for a job within the start condition.

- `kl`: Killed
- `nr`: Ended normally
- `wr`: Ended with warning
- `an`: Ended abnormally

`mm={and|or};`

Define the wait method with respect to the specified units whose ends are being waited for.

The default is `and`.

- `and`: Start executing at completion of all units whose ends are being waited for.
- `or`: Start executing at completion of one of the units whose ends are being waited for.

`nmg={y|n};`

Define the behavior when there are no generations of the root jobnet for the specified unit whose end is being waited for.

The default is `n`.

- `y`: Start executing.
- `n`: Do not start executing.

`eun=name-of-the-unit-whose-end-is-being-waited-for;`

Define the full-path name of a unit whose end is being waited for.

To specify multiple units, repeat the parameter. You can specify a maximum of 32 units.

You can use a character string of 1 to 930 bytes as the unit name.

`ega={exec|execdefer|none};`

Specify the behavior when a jobnet with start conditions is specified as the jobnet whose end is being waited for and the execution generation ends abnormally.

If you omit this option, the system assumes `none`.

- `exec`: Start executing.
- `execdefer`: Do not start executing. However, if the execution generation is in the *Skipped so not exe.* status, start executing.
- `none`: Do not start executing.

`uem={y|n};`

Specify the behavior when a jobnet with start conditions is specified as the jobnet whose end is being waited for and the monitoring generation is in the *Unmonitored + Ended* status.

If you omit this option, the system assumes `n`.

- `y`: Start executing.
- `n`: Do not start executing.

5.2.16 Execution-interval control job definition

This paragraph explains how to specify for an execution-interval control job definition.

The following gives the format of, and the parameter for an execution-interval control job definition.

Format

```
[tmitv=wait-time;]
[etn={y|n};]
[jpoif=macro-variable-name:passing-information-name;]
[etm=n;]
[fd=time-required-for-execution;]
[ex="execution-agent-name";]
[ha={y|n};]
[eu={ent|def};]
[ets={k|nr|wr|an};]
[mm={and|or};]
[nmg={y|n};]
[eun=name-of-the-unit-whose-end-is-being-waited-for;]
[ega={exec|execdefer|none};]
[uem={y|n};]
```

Parameters

`tmitv=wait-time;`

Define wait time.

You can set 1 to 1,440 minutes. The default is 10.

`etn={y|n};`

If you define the execution-interval control job as a start condition, specify whether to complete the job immediately after it is started. If you omit this option, the system assumes `n`.

- `y`: Completes the job immediately after it is started and starts the first execution instantly.
- `n`: The job is not completed immediately after it is started. Instead, the job waits until the time specified as the wait time passes, and then starts its first execution.

You cannot specify *y* for this parameter for the execution-interval control job defined for a normal jobnet instead of as a start condition. If you do so, the KAVS0669-E message is output, and the execution-interval control job cannot be created.

`jpoif=macro-variable-name:passing-information-name;`

Set *macro-variable-name* as a character string of no more than 64 bytes, using the format `?AJS2xxxx?`. In the *xxxxx* part, you can use uppercase alphabetic characters (A to Z), numerals (0 to 9), and periods (.).

This parameter can contain up to 2,048 bytes in the `"jpoif=macro-variable-name:passing-information-name;"`.

This parameter makes it possible to take over event information of subsequent Unix jobs, PC jobs, flexible jobs, HTTP connection jobs, and action jobs.

`etm=n;`

Define the time-out period using the relative minutes from the start time. You can set 1 to 1,440 minutes. This parameter is invalid for a job within the start condition.

`fd=time-required-for-execution;`

Define the time-required-for-execution within which the job is expected to be terminated.

You can specify a decimal value between 1 and 1,440 (minutes).

If you define this parameter as a start condition, it is disabled when a job is executed.

`ex="execution-agent-name";`

Define the name of the execution agent that is used to execute jobs.

You can set a character string of 1 to 255 bytes.

If you want to use a double quotation mark (") or a hash mark (#) as a character, prefix the character with #. That is, use #`"` instead of `"`, and use ## instead of #.

You can specify a macro variable.

`ha={y|n};`

Define whether to suspend job execution. The default is *n*. This parameter is invalid for a job within the start condition.

- *y*: Suspends job execution.
- *n*: Does not suspend job execution.

`eu={ent|def};`

Define the JP1 user who executes the job. The default is *ent*. This parameter is ignored in an event job.

- *ent*: The JP1 user who registered the jobnet executes the job.
- *def*: The JP1 user who owns the job executes the job.

`ets={k1|nr|wr|an};`

Define the state of the event job after the execution time-out period elapses. The default is *k1*. This parameter is invalid for a job within the start condition.

- *k1*: Killed
- *nr*: Ended normally
- *wr*: Ended with warning
- *an*: Ended abnormally

`mm={and|or};`

Define the wait method with respect to the specified units whose ends are being waited for.

The default is `and`.

- `and`: Start executing at completion of all units whose ends are being waited for.
- `or`: Start executing at completion of one of the units whose ends are being waited for.

`nmg={y|n};`

Define the behavior when there are no generations of the root jobnet for the specified unit whose end is being waited for.

The default is `n`.

- `y`: Start executing.
- `n`: Do not start executing.

`eun=name-of-the-unit-whose-end-is-being-waited-for;`

Define the full-path name of a unit whose end is being waited for.

To specify multiple units, repeat the parameter. You can specify a maximum of 32 units.

You can use a character string of 1 to 930 bytes as the unit name.

`ega={exec|execdefer|none};`

Specify the behavior when a jobnet with start conditions is specified as the jobnet whose end is being waited for and the execution generation ends abnormally.

If you omit this option, the system assumes `none`.

- `exec`: Start executing.
- `execdefer`: Do not start executing. However, if the execution generation is in the *Skipped so not exe.* status, start executing.
- `none`: Do not start executing.

`uem={y|n};`

Specify the behavior when a jobnet with start conditions is specified as the jobnet whose end is being waited for and the monitoring generation is in the *Unmonitored + Ended* status.

If you omit this option, the system assumes `n`.

- `y`: Start executing.
- `n`: Do not start executing.

5.2.17 JP1 event sending job definition

This paragraph explains how to specify a definition for a JP1 event sending job.

The following gives the format of, and the parameters for a JP1 event sending job definition.

Format

```
[evsid=event-ID;]
[evhst="event-destination-host-name";]
[evsms="message";]
[evssv={em|al|cr|er|wr|no|in|db};]
[evsfr=extended-attribute-name:"value";]
[pfm={u|p};]
[etm=n;]
[fd=time-required-for-execution;]
[ex="execution-agent-name";]
```

```
[ha={y|n};]
[eu={ent|def};]
[evsrt={y|n};]
[evspl=check-interval;]
[evsrc=check-count;]
[jty={q|n};]
[mm={and|or};]
[nmg={y|n};]
[eun=name-of-the-unit-whose-end-is-being-waited-for;]
[ega={exec|execdeffer|none};]
[uem={y|n};]
```

Parameters

`evsid=event-ID;`

Define the event ID of an event to be sent.

You can set hexadecimal values of 00000000 to 00001FFF and 7FFF8000 to 7FFFFFFF.

`evhst="event-destination-host-name";`

Define an event destination host name. This parameter is required if you specify `y` for the `evsrt` parameter.

You can set a character string of 1 to 255 bytes.

You can specify a macro variable.

`evsms="message";`

Define a message to be added to an event. You can set a character string of 1 to 1,023 bytes.

You can specify a macro variable.

`evssv={em|al|cr|er|wr|no|in|db};`

Define the event level to be added to an event. The default is `no`.

- `em`: Sets Emergency.
- `al`: Sets Alert.
- `cr`: Sets Critical.
- `er`: Sets Error.
- `wr`: Sets Warning.
- `no`: Sets Notice.
- `in`: Sets Information.
- `db`: Sets Debug.

`evsfr=extended-attribute-name:"value";`

Define an extended attribute to be added to an event.

You can set a character string of 5 to 128 bytes in the format of `evsfr=extended-attribute-name:"value";`.

You can specify a macro variable.

`pfm={u|p};`

Define a platform type for job execution. The default is `p`.

- `p`: Windows environment
- `u`: UNIX environment

`etm=n;`

Define the time-out period using the relative minutes from the start time. You can set 1 to 1,440 minutes.

`fd=time-required-for-execution;`

Define the time-required-for-execution within which the job is expected to be terminated.

You can specify a decimal value between 1 and 1,440 (minutes).

`ex="execution-agent-name";`

Define the name of the execution agent or execution agent group that is used to execute jobs.

You can set a character string of 1 to 255 bytes.

If you want to use a double quotation mark (") or a hash mark (#) as a character, prefix the character with #. That is, use #" instead of ", and use ## instead of #.

If the job has the queuing attribute (`jty=q`), you can specify a macro variable.

`ha={y|n};`

Define whether to suspend job execution. The default is `n`.

- `y`: Suspends job execution.
- `n`: Does not suspend job execution.

`eu={ent|def};`

Define the JP1 user who executes the job. The default is `ent`.

- `ent`: The JP1 user who registered the jobnet executes the job.
- `def`: The JP1 user who owns the job executes the job.

`evsrt={y|n};`

Define whether to check the arrival of the event. The default is `n`.

When you specify `y`, the system checks for the arrival of an event three seconds after the JP1 event is sent.

- `y`: Checks the arrival of the event.
- `n`: Does not check the arrival of the event.

`evspl=check-interval;`

Define the interval to check for arrival of a JP1 event. You can specify a decimal value between 3 and 600 (seconds).

If you omit this option, the system assumes 10.

`evsrc=check-count;`

Define how many times to check for arrival of a JP1 event. You can specify a decimal value between 0 and 999 (times).

If you omit this option, the system assumes 10.

`jty={q|n};`

Define the queuing attribute type. If you do not specify this option, `q` is assumed.

- `q`: The queuing attribute exists.
- `n`: The queuing attribute does not exist.

`mm={and|or};`

Define the wait method with respect to the specified units whose ends are being waited for.

The default is `and`.

- `and`: Start executing at completion of all units whose ends are being waited for.
- `or`: Start executing at completion of one of the units whose ends are being waited for.

nmg={ y | n } ;

Define the behavior when there are no generations of the root jobnet for the specified unit whose end is being waited for.

The default is n.

- y: Start executing.
- n: Do not start executing.

eun=*name-of-the-unit-whose-end-is-being-waited-for* ;

Define the full-path name of a unit whose end is being waited for.

To specify multiple units, repeat the parameter. You can specify a maximum of 32 units.

You can use a character string of 1 to 930 bytes as the unit name.

ega={ exec | execdefer | none } ;

Specify the behavior when a jobnet with start conditions is specified as the jobnet whose end is being waited for and the execution generation ends abnormally.

If you omit this option, the system assumes none.

- exec: Start executing.
- execdefer: Do not start executing. However, if the execution generation is in the *Skipped so not exe.* status, start executing.
- none: Do not start executing.

uem={ y | n } ;

Specify the behavior when a jobnet with start conditions is specified as the jobnet whose end is being waited for and the monitoring generation is in the *Unmonitored + Ended* status.

If you omit this option, the system assumes n.

- y: Start executing.
- n: Do not start executing.

Cautionary notes

The following describes the notes on defining the event destination host name, the message, and the value of the extended attribute.

- You can use space characters and symbols. However, if you use a special character (` , \$, or \) as an ordinary character in UNIX, it must be preceded by the \ mark.

Examples

< ` > will be specified as < \ ` >.

< \$ > will be specified as < \ \$ >.

- If you want to use a double quotation mark (") or a hash mark (#) as a character, prefix the character by # .

Examples

< " > will be specified as < # " >.

< # > will be specified as < # # >.

- If you want to use a double quotation mark (") as an ordinary character, prefix the quotation mark by the cast character string \ # .

Example

< " > should be specified as < \ # " >.

The values of the event destination host name, message, and extended attribute are enclosed in double quotation marks (") for JP1 event sending, because these specifications might contain space characters and symbols. If you

want to specify a \ mark as an ordinary character at the end of a character string in Windows, prefix another \ mark to it.

If passing information contains such a special character, the system may fail to pass on the information correctly or the job may terminate abnormally. If, however, you use the option that validates a double-quotation mark in passing information, any passing information containing a double-quotation mark will be taken over correctly.

Example

The following examples show how to use a special character, a double quotation mark ("), and a hash mark (#) as an ordinary character for the values of the event destination host name, message, and extended attribute.

- <`AAA`> will be specified as <\`AAA\`>. (For UNIX only)
- <\${AAA}> will be specified as <\\${AAA}\\$>. (For UNIX only)
- <#AAA#> will be specified as <##AAA##>.
- <"AAA"> will be specified as <\#"AAA\#">.
- <\\AAA\\> will be specified as <\\AAA\\>> (for Windows) or <\\AAA\\> (for UNIX).

5.2.18 Email sending job definition

This paragraph explains how to specify a definition for an email sending job.

The following gives the format of, and the parameters for an email sending job definition.

Format

```
[mladr={to|cc|bcc}:"address";]
[mlprf="profile-name";]
[mlsbj="subject";]
[mltx="text";]
[mlftx="text-file-name";]
[mlatf="attached-file-name";]
[mlafl="attached-file-list-name";]
[pfm={u|p};]
[etm=n];]
[fd=time-required-for-execution;]
[ex="execution-agent-name";]
[ha={y|n};]
[eu={ent|def};]
[jty={q|n};]
[mm={and|or};]
[nmg={y|n};]
[eun=name-of-the-unit-whose-end-is-being-waited-for;]
[ega={exec|execdeffer|none};]
[uem={y|n};]
```

Parameters

`mladr={to|cc|bcc}:"address";`

Define the email address of a destination.

In the format of `mladr={to|cc|bcc}:"address";`, you can set up to 20 email addresses at one time.

- `to`: Sends email to a destination.
- `cc`: Sends a copy of email to a destination.

- `bcc`: Sends a blind carbon copy of email to a destination.

You can set a character string of 1 to 256 bytes for an address.

If you want to use a double quotation mark (") or a hash mark (#) as a character, prefix the character by #. That is, use # " instead of " and use ## instead of #.

You can specify a macro variable in the address.

The following table lists the address formats you can use when `pfm=p`; is specified:

| Profile type | Address format |
|---------------------------|--|
| Exchange Server# | <ul style="list-style-type: none"> • Display name • Alias • Internet mail address |
| Internet mail (SMTP/POP3) | Internet mail address |

#

Email cannot be sent to X.400 format addresses.

The following is an example of an address in X.400 format:

```
c=JP;p=MailServer;o=Exchange;g=Taro;s=Hitachi;
```

If the host that executes the email sending job is a Windows host, and Outlook is used, specify no more than 255 characters for the destination. You can specify 256 or fewer bytes for the destination; however, if you specify 256 or more characters, only the first 255 characters will be assumed as the destination.

```
m1prf="profile-name";
```

Specify one of the profile names set in the `ProfileName1` to `ProfileName4` environment setting parameters on the agent host on which the email sending job is executed.

This parameter is valid only when you specify `pfm=p`; . This parameter becomes necessary item if you specify `pfm=p` ; .

You can set a character string of 1 to 256 bytes.

If you want to use a double quotation mark (") or a hash mark (#) as a character, prefix the character by #. That is, use # " instead of " and use ## instead of #.

You can specify a macro variable.

For details about the environment setting parameters, see *2.3.4 Setting up the environment for the mail system linkage* in the *JP1/Automatic Job Management System 3 Linkage Guide*.

```
m1sbj="subject";
```

Define the subject of the email to be sent.

You can set a character string of 0 to 256 bytes.

If you want to use a double quotation mark (") or a hash mark (#) as a character, prefix the character by #. That is, use # " instead of " and use ## instead of #.

You can specify a macro variable.

If the host that executes the email sending job is a Windows host, and Outlook is used, specify no more than 255 characters for the subject. You can specify 256 or fewer bytes for the subject; however, if you specify 256 or more characters, only the first 255 characters will be assumed as the subject name.

```
m1txt="text";
```

Define the text of the email to be sent.

You can specify a string of 1 to 512 bytes (including the number of linefeeds). In UNIX, the final line always contains a linefeed because without a linefeed, the final line is not handled as a line.

If you want to use a double quotation mark (") or a hash mark (#) as a character, prefix the character by #. That is, use #" instead of " and use ## instead of #.

You can specify a macro variable.

```
m1ftx="text-file-name";
```

Define the text file name of the email to be sent.

You can set a character string of 1 to 256 bytes. Specify a full-path file name.

If you want to use a double quotation mark (") or a hash mark (#) as a character, prefix the character by #. That is, use #" instead of " and use ## instead of #.

You can specify a macro variable.

```
m1atf="attached-file-name";
```

Define an attached file name. This parameter is valid only when you specify pfm=p;.

In the format of m1atf="attached-file-name";, you can set up to 20 file names at one time.

You can set a character string of 1 to 256 bytes. Specify a full-path file name.

If you want to use a double quotation mark (") or a hash mark (#) as a character, prefix the character by #. That is, use #" instead of " and use ## instead of #.

You can specify a macro variable.

For the format of a list of attached files, see 2.7.3 *List of attached files to be sent (Windows only)* in the *JP1/Automatic Job Management System 3 Linkage Guide*.

```
m1afl="attached-file-list-name";
```

Define a list file name for an attached file. This parameter is valid only when you specify pfm=p;.

You can set a character string of 1 to 256 bytes. Specify a full-path file name.

If you want to use a double quotation mark (") or a hash mark (#) as a character, prefix the character by #. That is, use #" instead of " and use ## instead of #.

You can specify a macro variable.

```
pfm={u|p};
```

Define a platform type for job execution. The default is p.

- u: UNIX environment
- p: Windows environment

```
etm=n;
```

Define the time-out period using the relative minutes from the start time. You can set 1 to 1,440 minutes.

```
fd=time-required-for-execution;
```

Define the time-required-for-execution within which the job is expected to be terminated.

You can specify a decimal value between 1 and 1,440 (minutes).

```
ex="execution-agent-name";
```

Define the name of the execution agent or execution agent group that is used to execute jobs.

You can set a character string of 1 to 255 bytes.

If you want to use a double quotation mark (") or a hash mark (#) as a character, prefix the character with #. That is, use #" instead of ", and use ## instead of #.

If the job has the queuing attribute (jty=q), you can specify a macro variable.

```
ha={y|n};
```

Define whether to suspend job execution. The default is n.

- y: Suspends job execution.

- `n`: Does not suspend job execution.

`eu={ent|def};`

Define the JP1 user who executes the job. The default is `ent`.

- `ent`: The JP1 user who registered the jobnet executes the job.
- `def`: The JP1 user who owns the job executes the job.

`jty={q|n};`

Define the queuing attribute type. If you do not specify this option, `q` is assumed.

- `q`: The queuing attribute exists.
- `n`: The queuing attribute does not exist.

`mm={and|or};`

Define the wait method with respect to the specified units whose ends are being waited for.

The default is `and`.

- `and`: Start executing at completion of all units whose ends are being waited for.
- `or`: Start executing at completion of one of the units whose ends are being waited for.

`nmg={y|n};`

Define the behavior when there are no generations of the root jobnet for the specified unit whose end is being waited for.

The default is `n`.

- `y`: Start executing.
- `n`: Do not start executing.

`eun=name-of-the-unit-whose-end-is-being-waited-for;`

Define the full-path name of a unit whose end is being waited for.

To specify multiple units, repeat the parameter. You can specify a maximum of 32 units.

You can use a character string of 1 to 930 bytes as the unit name.

`ega={exec|execdefer|none};`

Specify the behavior when a jobnet with start conditions is specified as the jobnet whose end is being waited for and the execution generation ends abnormally.

If you omit this option, the system assumes `none`.

- `exec`: Start executing.
- `execdefer`: Do not start executing. However, if the execution generation is in the *Skipped so not exe.* status, start executing.
- `none`: Do not start executing.

`uem={y|n};`

Specify the behavior when a jobnet with start conditions is specified as the jobnet whose end is being waited for and the monitoring generation is in the *Unmonitored + Ended* status.

If you omit this option, the system assumes `n`.

- `y`: Start executing.
- `n`: Do not start executing.

5.2.19 Message-queue message sending job definition

This paragraph explains how to specify a definition for a message-queue message sending job.

The following gives the format of, and the parameters for a message-queue message sending job definition.

Format

```
[mqque=queue-name ;]
[mqcor=correlation-ID ;]
[mqdsc=message-ID ;]
[mqprm={y|n} ;]
[mqmgr=queue-manager-name ;]
[mqmdl=model-queue-name ;]
[mqppgm=related-queue-management-program-name ;]
[mqmfn=format-name ;]
[mqmdn="message-data-file-name";]
[mqhld=hold-time ;]
[mqpri=priority ;]
[mqeqn=dead-letter-queue-name ;]
[pfm={u|p} ;]
[etm=n ;]
[fd=time-required-for-execution ;]
[ex="execution-agent-name" ;]
[ha={y|n} ;]
[eu={ent|def} ;]
[jty={q|n} ;]
[mm={and|or} ;]
[nmg={y|n} ;]
[eun=name-of-the-unit-whose-end-is-being-waited-for ;]
[ega={exec|execdefer|none} ;]
[uem={y|n} ;]
```

Parameters

mqque=queue-name ;

Define the name of a queue to be sent the message.

You can set a character string of 1 to 48 bytes. Specify a queue name using an MQ character string.

mqcor=correlation-ID ;

Define a correlation ID to be added to a send message.

You can set a character string of 1 to 24 bytes. You can, however, set only uppercase alphanumeric characters.

mqdsc=message-ID ;

Define a message ID to be added to a send message.

You can set a character string of 1 to 24 bytes. You can, however, set only uppercase alphanumeric characters.

mqprm={y|n} ;

Define the permanence of a message to be sent. The default is n.

- *y*: Permanent
- *n*: Not permanent

mqmgr=queue-manager-name ;

Define the name of a queue manager for sending the message.

You can set a character string of 1 to 48 bytes. Specify a queue manager name using an MQ character string.

`mqmdl=model-queue-name;`

Define the name of a model queue for sending the message.

You can set a character string of 1 to 48 bytes. Specify a model queue name using an MQ character string.

`mqpgm=related-queue-management-program-name;`

Define a program name for message destination queue management or a program name for queue management that allows you to identify a queue name.

You can set a character string of 1 to 48 bytes. Specify a program name using an MQ character string.

`mqmfn=format-name;`

Define a format to identify the format of the information in message data.

You can set a character string of 1 to 8 bytes. You can, however, set only uppercase alphanumeric characters.

`mqmdn="message-data-file-name";`

Define the name of a message data file to be sent as the message.

You can set a character string of 1 to 256 bytes.

If you want to use a double quotation mark (") or a hash mark (#) as a character, prefix the character by #. That is, use #" instead of " and use ## instead of #.

You can specify a macro variable.

`mqhld=hold-time;`

Define hold time for a message to be sent.

You can set 1 to 9,999,999 minutes.

`mqpri=priority;`

Define the priority of a message to be sent.

You can set 0 to 9.

`mqeqn=dead-letter-queue-name;`

Define the queue name of a related queue management program to which the message is to be transferred if message send processing encounters an error.

You can set a character string of 1 to 48 bytes. Specify a dead letter queue name using an MQ character string.

`pfm={u|p};`

Define a platform type for job execution. The default is p.

- u: UNIX environment
- p: Windows environment

`etm=n;`

Define the time-out period using the relative minutes from the start time. You can set 1 to 1,440 minutes.

`fd=time-required-for-execution;`

Define the time-required-for-execution within which the job is expected to be terminated.

You can specify a decimal value between 1 and 1,440 (minutes).

`ex="execution-agent-name";`

Define the name of the execution agent or execution agent group that is used to execute jobs.

You can set a character string of 1 to 255 bytes.

If you want to use a double quotation mark (") or a hash mark (#) as a character, prefix the character with #. That is, use #" instead of ", and use ## instead of #.

ha={y|n};

Define whether to suspend job execution. The default is n.

- y: Suspends job execution.
- n: Does not suspend job execution.

eu={ent|def};

Define the JP1 user who executes the job. The default is ent.

- ent: The JP1 user who registered the jobnet executes the job.
- def: The JP1 user who owns the job executes the job.

jty={q|n};

Define the queuing attribute type. If you do not specify this option, q is assumed.

- q: The queuing attribute exists.
- n: The queuing attribute does not exist.

mm={and|or};

Define the wait method with respect to the specified units whose ends are being waited for. The default is and.

- and: Start executing at completion of all units whose ends are being waited for.
- or: Start executing at completion of one of the units whose ends are being waited for.

nmg={y|n};

Define the behavior when there are no generations of the root jobnet for the specified unit whose end is being waited for.

The default is n.

- y: Start executing.
- n: Do not start executing.

eun=*name-of-the-unit-whose-end-is-being-waited-for*;

Define the full-path name of a unit whose end is being waited for.

To specify multiple units, repeat the parameter. You can specify a maximum of 32 units.

You can use a character string of 1 to 930 bytes as the unit name.

ega={exec|execdeffer|none};

Specify the behavior when a jobnet with start conditions is specified as the jobnet whose end is being waited for and the execution generation ends abnormally.

If you omit this option, the system assumes none.

- exec: Start executing.
- execdeffer: Do not start executing. However, if the execution generation is in the *Skipped so not exe.* status, start executing.
- none: Do not start executing.

uem={y|n};

Specify the behavior when a jobnet with start conditions is specified as the jobnet whose end is being waited for and the monitoring generation is in the *Unmonitored + Ended* status.

If you omit this option, the system assumes n.

- y: Start executing.

- n: Do not start executing.

5.2.20 MSMQ message sending job definition

This paragraph explains how to specify an MSMQ message sending job definition.

The following gives the format of, and the parameters for MSMQ message sending job definition information.

Format

```
[msqpt="queue-path-name";]
[msqlb="queue-label-name";]
[msrer=correlation-ID;]
[mslmt={-2|-1|n};]
[mshld={-1|n};]
[msmod={h|r};]
[mspri=priority;]
[msjnl={y|n};]
[msunr={y|n};]
[mstfn="text-file-name";]
[msttp=text-type;]
[mslbl="message-label";]
[msapl=application-information;]
[etm=n;]
[fd=time-required-for-execution;]
[ex="execution-agent-name";]
[ha={y|n};]
[eu={ent|def};]
[jty={q|n};]
[mm={and|or};]
[nmg={y|n};]
[eun=name-of-the-unit-whose-end-is-being-waited-for;]
[ega={exec|execdefer|none};]
[uem={y|n};]
```

Parameters

`msqpt="queue-path-name";`

Define the path name of a destination queue to be sent the message.

You can set a character string of 1 to 259 bytes.

If you want to use a double quotation mark (") or a hash mark (#) as a character, prefix the character by #. That is, use #" instead of " and use ## instead of #.

If you define both `msqpt="queue-path-name";` and `msqlb="queue-label-name";`, the latter is invalid.

You can specify a macro variable.

`msqlb="queue-label-name";`

Define the label name of a destination queue to be sent the message.

You can set a character string of 1 to 124 bytes.

If you want to use a double quotation mark (") or a hash mark (#) as a character, prefix the character by #. That is, use #" instead of " and use ## instead of #.

If you define both `msqpt="queue-path-name";` and `msqlb="queue-label-name";`, the latter is invalid.

You can specify a macro variable.

`msrer=correlation-ID;`

Define the correlation ID of a send message.

You can set a character string of 1 to 20 bytes. You can, however, specify only uppercase alphanumeric characters.

`mslmt={-2|-1|n};`

Define the delivery limit time for a send message. The default is -2.

- -2: LONG_LIVED
- -1: INFINITE
- *n*: Specify the delivery limit time in seconds. You can set 0 to 2,147,483,647.

`mshld={-1|n};`

Define the period in which message sending is suspended. The default is -1.

- -1: INFINITE
- *n*: Specify the time period in seconds. You can set 0 to 2,147,483,647.

`msmod={h|r};`

Define delivery mode for a send message. The default is h.

- h: High-speed mode
- r: Recoverable mode

`mspri=priority;`

Define the priority of a send message.

You can set 0 to 7. The default is 3.

`msjnl={y|n};`

Define whether to store a delivered message into the journal queue. The default is n.

- y: Stores a delivered message into the journal queue.
- n: Does not store a delivered message into the journal queue.

`msunr={y|n};`

Define whether to store a delivered message into the dead message queue. The default is n.

- y: Stores a delivered message into the dead message queue.
- n: Does not store a delivered message into the dead message queue.

`mstfn="text-file-name";`

Define the name of the file which stores data to be used as the send message text.

You can set a character string of 1 to 259 bytes. Specify a full-path file name.

If you want to use a double quotation mark (") or a hash mark (#) as a character, prefix the character by #. That is, use #" instead of " and use ## instead of #.

You can specify a macro variable.

`msttp=text-type;`

Define the content type of send message text.

You can set hexadecimal values of 0 to FFFFFFFF.

`mslbl="message-label";`

Define the label of a send message.

You can set a character string of 1 to 249 bytes.

If you want to use a double quotation mark (") or a hash mark (#) as a character, prefix the character by #. That is, use #" instead of " and use ## instead of #.

You can specify a macro variable.

```
msapl=application-information;
```

Define application information on a send message.

You can set hexadecimal values of 0 to FFFFFFFF.

```
etm=n;
```

Define the time-out period using the relative minutes from the start time. You can set 1 to 1,440 minutes.

```
fd=time-required-for-execution;
```

Define the time-required-for-execution within which the job is expected to be terminated.

You can specify a decimal value between 1 and 1,440 (minutes).

```
ex="execution-agent-name";
```

Define the name of the execution agent or execution agent group that is used to execute jobs.

You can set a character string of 1 to 255 bytes.

If you want to use a double quotation mark (") or a hash mark (#) as a character, prefix the character with #. That is, use #" instead of ", and use ## instead of #.

```
ha={y|n};
```

Define whether to suspend job execution. The default is n.

- *y*: Suspends job execution.
- *n*: Does not suspend job execution.

```
eu={ent|def};
```

Define the JP1 user who executes the job. The default is *ent*.

- *ent*: The JP1 user who registered the jobnet executes the job.
- *def*: The JP1 user who owns the job executes the job.

```
jty={q|n};
```

Define the queuing attribute type. If you do not specify this option, *q* is assumed.

- *q*: The queuing attribute exists.
- *n*: The queuing attribute does not exist.

```
mm={and|or};
```

Define the wait method with respect to the specified units whose ends are being waited for.

The default is *and*.

- *and*: Start executing at completion of all units whose ends are being waited for.
- *or*: Start executing at completion of one of the units whose ends are being waited for.

```
nmg={y|n};
```

Define the behavior when there are no generations of the root jobnet for the specified unit whose end is being waited for.

The default is *n*.

- *y*: Start executing.
- *n*: Do not start executing.

`eun=name-of-the-unit-whose-end-is-being-waited-for;`

Define the full-path name of a unit whose end is being waited for.

To specify multiple units, repeat the parameter. You can specify a maximum of 32 units.

You can use a character string of 1 to 930 bytes as the unit name.

`ega={exec|execdeffer|none};`

Specify the behavior when a jobnet with start conditions is specified as the jobnet whose end is being waited for and the execution generation ends abnormally.

If you omit this option, the system assumes `none`.

- `exec`: Start executing.
- `execdeffer`: Do not start executing. However, if the execution generation is in the *Skipped so not exe.* status, start executing.
- `none`: Do not start executing.

`uem={y|n};`

Specify the behavior when a jobnet with start conditions is specified as the jobnet whose end is being waited for and the monitoring generation is in the *Unmonitored + Ended* status.

If you omit this option, the system assumes `n`.

- `y`: Start executing.
- `n`: Do not start executing.

5.2.21 OpenView Status Report job definition

This paragraph explains how to specify an OpenView Status Report job definition.

The following gives the format of, and the parameters for an OpenView Status Report job definition.

Format

```
[cmsts={un|no|wa|mi|ma|cr|re|te|di};]  
[cmaif="additional-information";]  
[pfm={u|p};]  
[etm=n;]  
[fd=time-required-for-execution;]  
[ex="execution-agent-name";]  
[ha={y|n};]  
[eu={ent|def};]  
[jty={q|n};]  
[mm={and|or};]  
[nmg={y|n};]  
[eun=name-of-the-unit-whose-end-is-being-waited-for;]  
[ega={exec|execdeffer|none};]  
[uem={y|n};]
```

Parameters

`cmsts={un|no|wa|mi|ma|cr|re|te|di};`

Define the status to be reported to HP NNM. The default is `un`.

- `un`: Unknown
- `no`: Normal

- wa: Warning
- mi: Minor
- ma: Major
- cr: Critical
- re: Restricted
- te: Testing
- di: Disabled

`cmaif="additional-information";`

Define additional information about a message to be reported to HP NNM.

You can set a character string of 1 to 256 bytes. Note that you cannot use a carriage-return character.

If you want to use a double quotation mark (") or a hash mark (#) as a character, prefix the character by #. That is, use #" instead of " and use ## instead of #.

You can specify a macro variable.

`pfm={u|p};`

Define a platform type for job execution. The default is p.

- u: UNIX environment
- p: Windows environment

`etm=n;`

Define the time-out period using the relative minutes from the start time. You can set 1 to 1,440 minutes.

`fd=time-required-for-execution;`

Define the time-required-for-execution within which the job is expected to be terminated.

You can specify a decimal value between 1 and 1,440 (minutes).

`ex="execution-agent-name";`

Define the name of the execution agent or execution agent group that is used to execute jobs.

You can set a character string of 1 to 255 bytes.

If you want to use a double quotation mark (") or a hash mark (#) as a character, prefix the character with #. That is, use #" instead of ", and use ## instead of #.

If the job has the queuing attribute (jty=q), you can specify a macro variable.

`ha={y|n};`

Define whether to suspend job execution. The default is n.

- y: Suspends job execution.
- n: Does not suspend job execution.

`eu={ent|def};`

Define the JP1 user who executes the job. The default is ent.

- ent: The JP1 user who registered the jobnet executes the job.
- def: The JP1 user who owns the job executes the job.

`jty={q|n};`

Define the queuing attribute type. If you do not specify this option, q is assumed.

- q: The queuing attribute exists.

- `n`: The queuing attribute does not exist.

`mm={and|or};`

Define the wait method with respect to the specified units whose ends are being waited for.

The default is `and`.

- `and`: Start executing at completion of all units whose ends are being waited for.
- `or`: Start executing at completion of one of the units whose ends are being waited for.

`nmg={y|n};`

Define the behavior when there are no generations of the root jobnet for the specified unit whose end is being waited for.

The default is `n`.

- `y`: Start executing.
- `n`: Do not start executing.

`eun=name-of-the-unit-whose-end-is-being-waited-for;`

Define the full-path name of a unit whose end is being waited for.

To specify multiple units, repeat the parameter. You can specify a maximum of 32 units.

You can use a character string of 1 to 930 bytes as the unit name.

`ega={exec|execdefer|none};`

Specify the behavior when a jobnet with start conditions is specified as the jobnet whose end is being waited for and the execution generation ends abnormally.

If you omit this option, the system assumes `none`.

- `exec`: Start executing.
- `execdefer`: Do not start executing. However, if the execution generation is in the *Skipped so not exe.* status, start executing.
- `none`: Do not start executing.

`uem={y|n};`

Specify the behavior when a jobnet with start conditions is specified as the jobnet whose end is being waited for and the monitoring generation is in the *Unmonitored + Ended* status.

If you omit this option, the system assumes `n`.

- `y`: Start executing.
- `n`: Do not start executing.

5.2.22 Local power control job definition

This paragraph explains how to specify definition for a local power control job.

The following gives the format of, and the parameters for a local power control job definition.

Format

```
[pwl t={f|r|s};]
[pwl f={m|r|f|p};]
[pfm={u|p};]
[etm=n;]
```

```
[fd=time-required-for-execution;]
[ex="execution-agent-name";]
[ha={y|n};]
[eu={ent|def};]
[jty={q|n};]
[mm={and|or};]
[nmg={y|n};]
[eun=name-of-the-unit-whose-end-is-being-waited-for;]
[ega={exec|execdeffer|none};]
[uem={y|n};]
```

Parameters

`pwl t={f|r|s};`

Define the type of execution. The default is `f`.

- `f`: Turns off power. The JP1/AJS3 host will then be started at the time specified in JP1/AJS3 - Manager. For details, see the manual *JP1/Power Monitor Description, User's Guide and Reference*.
- `r`: Shuts down, then restarts the local power supply.
- `s`: Shuts down the local power supply. (You can specify this only with `pfm=p; set`.)

`pwl f={m|r|f|p};`

Define the type of termination request. The default is `f`.

- `m`: (You can specify this only with `pfm=u; set`.)
- `r`: Restrictive termination. (You can specify this only with `pfm=u; set`.)
- `f`: Kill
- `p`: Planned termination. (You can specify this only with `pfm=p; set`.)

`pfm={u|p};`

Define a platform type for job execution. The default is `p`.

- `u`: UNIX environment
- `p`: Windows environment

`etm=n;`

Define the time-out period using the relative minutes from the start time. You can set 1 to 1,440 minutes.

`fd=time-required-for-execution;`

Define the time-required-for-execution within which the job is expected to be terminated.

You can specify a decimal value between 1 and 1,440 (minutes).

`ex="execution-agent-name";`

Define the name of the execution agent or execution agent group that is used to execute jobs.

You can set a character string of 1 to 255 bytes.

If you want to use a double quotation mark (") or a hash mark (#) as a character, prefix the character with #. That is, use #" instead of ", and use ## instead of #.

If the job has the queuing attribute (`jty=q`), you can specify a macro variable.

`ha={y|n};`

Define whether to suspend job execution. The default is `n`.

- `y`: Suspends job execution.
- `n`: Does not suspend job execution.

`eu={ent|def};`

Define the JP1 user who executes the job. The default is `ent`.

- `ent`: The JP1 user who registered the jobnet executes the job.
- `def`: The JP1 user who owns the job executes the job.

`jty={q|n};`

Define the queuing attribute type. If you do not specify this option, `q` is assumed.

- `q`: The queuing attribute exists.
- `n`: The queuing attribute does not exist.

`mm={and|or};`

Define the wait method with respect to the specified units whose ends are being waited for. The default is `and`.

- `and`: Start executing at completion of all units whose ends are being waited for.
- `or`: Start executing at completion of one of the units whose ends are being waited for.

`nmg={y|n};`

Define the behavior when there are no generations of the root jobnet for the specified unit whose end is being waited for.

The default is `n`.

- `y`: Start executing.
- `n`: Do not start executing.

`eun=name-of-the-unit-whose-end-is-being-waited-for;`

Define the full-path name of a unit whose end is being waited for.

To specify multiple units, repeat the parameter. You can specify a maximum of 32 units.

You can use a character string of 1 to 930 bytes as the unit name.

`ega={exec|execdefer|none};`

Specify the behavior when a jobnet with start conditions is specified as the jobnet whose end is being waited for and the execution generation ends abnormally.

If you omit this option, the system assumes `none`.

- `exec`: Start executing.
- `execdefer`: Do not start executing. However, if the execution generation is in the *Skipped so not exe.* status, start executing.
- `none`: Do not start executing.

`uem={y|n};`

Specify the behavior when a jobnet with start conditions is specified as the jobnet whose end is being waited for and the monitoring generation is in the *Unmonitored + Ended* status.

If you omit this option, the system assumes `n`.

- `y`: Start executing.
- `n`: Do not start executing.

5.2.23 Remote power control job definition

This paragraph explains how to specify a remote power control job definition.

The following gives the format of, and the parameters for a remote power control job definition.

Format

```
[pwrh="target-host-name";]
[pwrf={o|m|r|f|p|s};]
[pwrn={n|a|c:[mm/dd.]hh:mm};]
[pwrr={y|n};]
[pwrw={y|n};]
[pwrrp={p|u};]
[pfm={u|p};]
[etm=n;]
[fd=time-required-for-execution;]
[ex="execution-agent-name";]
[ha={y|n};]
[eu={ent|def};]
[jty={q|n};]
[mm={and|or};]
[nmg={y|n};]
[eun=name-of-the-unit-whose-end-is-being-waited-for;]
[ega={exec|execdefer|none};]
[uem={y|n};]
```

Parameters

`pwrh="target-host-name";`

Define the name of the JP1/Power Monitor agent host subject to power control.

You can set a character string of 1 to 255 bytes.

If you want to use a double quotation mark (") or a hash mark (#) as a character, prefix the character by #. That is, use #" instead of " and use ## instead of #.

You can specify a macro variable.

`pwrf={o|m|r|f|p|s};`

For the JP1/Power Monitor agent host, define the type of request for how to terminate the monitor application when the system terminates. The default is p if you specify p in `pwrrp`, or m if you specify u in `pwrrp`.

- o: Turns on power.
- m: Monitored termination. You can specify this only when `pwrrp=u`; is specified.
- r: Restrictive termination. You can specify this only when `pwrrp=u`; is specified.
- f: Kill
- p: Planned termination. You can specify this only when `pwrrp=p`; is specified.
- s: Forced stop

`pwrn={n|a|c:[mm/dd.]hh:mm};`

Define the time when the JP1/Power Monitor agent host will be turned on next. The default is a.

- n: Does not set the next power-on time.
- a: Validates the next power-on time that is set in the JP1/Power Monitor agent host.
- c: [mm/dd.]hh:mm: Specify the next power-on time.

mm: You can set 1 to 12 for the month.

dd: You can set 1 to 31 for the day.

hh: You can set 0 to 23 for the hours.

mm: You can set 0 to 59 for the minutes.

`pwr r={y|n};`

Define whether to restart the JP1/Power Monitor agent host after it is shut down. The default is *n*.

- *y*: Restarts the agent host.
- *n*: Does not restart the agent host.

`pwr w={y|n};`

Define whether to wait for completion of the turning off the JP1/Power Monitor agent host before terminating the remoter power control job. The default is *n*.

- *y*: Waits for the system to end.
- *n*: Does not wait for the system to end.

The end of power-off means that the JP1/Power Monitor on the agent host reports the start of a shutdown to the manager host of the JP1/Power Monitor.

`pwr p={p|u};`

Specify the type of platform for the target JP1/Power Monitor host (agent) responsible for performing power control using the remote power control job. The default is *p*.

- *p*: Controls the JP1/Power Monitor agent host in Windows.
- *u*: Controls the JP1/Power Monitor agent host in UNIX.

`p fm={u|p};`

Define a platform type for job execution. The default is *p*.

- *u*: UNIX environment
- *p*: Windows environment

`e tm=n;`

Define the time-out period using the relative minutes from the start time. You can set 1 to 1,440 minutes.

`f d=time-required-for-execution;`

Define the time-required-for-execution within which the job is expected to be terminated.

You can specify a decimal value between 1 and 1,440 (minutes).

`e x="execution-agent-name";`

Define the name of the execution agent or execution agent group that is used to execute jobs.

You can set a character string of 1 to 255 bytes.

If you want to use a double quotation mark (") or a hash mark (#) as a character, prefix the character with #. That is, use #" instead of ", and use ## instead of #.

If the job has the queuing attribute (*jt y=q*), you can specify a macro variable.

`h a={y|n};`

Define whether to suspend job execution. The default is *n*.

- *y*: Suspends job execution.
- *n*: Does not suspend job execution.

`eu={ent|def};`

Define the JP1 user who executes the job. The default is `ent`.

- `ent`: The JP1 user who registered the jobnet executes the job.
- `def`: The JP1 user who owns the job executes the job.

`jty={q|n};`

Define the queuing attribute type. If you do not specify this option, `q` is assumed.

- `q`: The queuing attribute exists.
- `n`: The queuing attribute does not exist.

`mm={and|or};`

Define the wait method with respect to the specified units whose ends are being waited for. The default is `and`.

- `and`: Start executing at completion of all units whose ends are being waited for.
- `or`: Start executing at completion of one of the units whose ends are being waited for.

`nmg={y|n};`

Define the behavior when there are no generations of the root jobnet for the specified unit whose end is being waited for.

The default is `n`.

- `y`: Start executing.
- `n`: Do not start executing.

`eun=name-of-the-unit-whose-end-is-being-waited-for;`

Define the full-path name of a unit whose end is being waited for.

To specify multiple units, repeat the parameter. You can specify a maximum of 32 units.

You can use a character string of 1 to 930 bytes as the unit name.

`ega={exec|execdefer|none};`

Specify the behavior when a jobnet with start conditions is specified as the jobnet whose end is being waited for and the execution generation ends abnormally.

If you omit this option, the system assumes `none`.

- `exec`: Start executing.
- `execdefer`: Do not start executing. However, if the execution generation is in the *Skipped so not exe.* status, start executing.
- `none`: Do not start executing.

`uem={y|n};`

Specify the behavior when a jobnet with start conditions is specified as the jobnet whose end is being waited for and the monitoring generation is in the *Unmonitored + Ended* status.

If you omit this option, the system assumes `n`.

- `y`: Start executing.
- `n`: Do not start executing.

5.2.24 UNIX/PC custom job definition

This paragraph explains how to specify a UNIX/PC custom job definition.

The following gives the format of, and the parameters for a UNIX/PC custom job definition.

Format

```
[cty="custom-job-class-name";]
[te="command-text";]
[sc="script-file-name";]
[prm="parameter";]
[env="environment-variable";]
[so="standard-output-file-name";]
[se="standard-error-output-file-name";]
[etm=n;]
[fd=time-required-for-execution;]
[pr=n;]
[ex="job-execution-agent-host-name";]
[un="target-user-name";]
[jd={nm|ab|cod|mdf|exf};]
[wth=n;]
[tho=n;]
[jdf="end-judgment-file-name";]
[abr={y|n};]
[rjs=lower-limit-of-return-codes-to-be-retried-automatically;]
[rje=upper-limit-of-return-codes-to-be-retried-automatically;]
[rec=maximum-number-of-retry-executions;]
[rei=retry-interval;]
[ha={y|n};]
[eu={ent|def};]
[wkp="work-path-name";]
[ev="environmental-variable-file-name";]
[si="standard-input-file-name";]
[soa={new|add};]
[sea={new|add};]
[ts1="transfer-source-file-name-1";]
[td1="transfer-destination-file-name-1";]
[top1={sav|del};]
[ts2="transfer-source-file-name-2";]
[td2="transfer-destination-file-name-2";]
[top2={sav|del};]
[ts3="transfer-source-file-name-3";]
[td3="transfer-destination-file-name-3";]
[top3={sav|del};]
[ts4="transfer-source-file-name-4";]
[td4="transfer-destination-file-name-4";]
[top4={sav|del};]
[mm={and|or};]
[nmg={y|n};]
[eun=name-of-the-unit-whose-end-is-being-waited-for;]
[ega={exec|execdeffer|none};]
[uem={y|n};]
```

Parameters

`cty="custom-job-class-name";`

Define a custom job class name for each linked program.

You can define the types of custom job class names given below.

- For standard custom jobs

The following gives the class names to be defined to use the custom jobs supported in the standard JP1/AJS3 configuration.

| Linked program name | Class name |
|--------------------------------------|-------------|
| JP1/FTP | JP1FTP |
| JP1/AJS3 for Enterprise Applications | JP1AMR3 |
| JP1/AJS3 for Enterprise Applications | JP1AMR3BW |
| JP1/AJS3 for Enterprise Applications | JP1AMR3CP |
| JP1/AJS3 for Enterprise Applications | JP1AMR3UX |
| JP1/AJS3 for Enterprise Applications | JP1AMR3BWUX |
| JP1/AJS3 for Enterprise Applications | JP1AMR3CPUX |
| JP1/DH - AJE | DHAJEW |
| JP1/CPA | CPALINK |

- For custom PC jobs and custom Unix jobs

Set *custom-job-class-name* as a character string of no more than 16 bytes, by using the format `USER_ any-name` (`USER_` cannot be omitted).

If you want to use a double quotation mark (") or a hash mark (#) as a character, prefix the character by #. That is, use #\" instead of \" and use ## instead of #.

If you specify any of the following, the icon of the custom job does not appear in the icon list of the Jobnet Editor window:

- \" (double quotation mark)
- *
- /
- : (colon)
- <
- >
- ?
- \
- |
- MS-DOS device names (NUL, CON, AUX, CLOCK\$, COM1 to COM9, LPT1 to LPT9, PRN)
- Character strings beginning with *MS-DOS-device-name* . (period)

Also, the following characters cannot be specified:

- Single-byte space
- Control characters such as a line-feed character or tab character

`te="command-text" ;`

Define command text.

You can set a character string of 1 to 1,023 bytes.

If you want to use a double quotation mark (") or a hash mark (#) as a character, prefix the character by #. That is, use #\" instead of \" and use ## instead of #.

You can specify a macro variable.

`sc="script-file-name" ;`

For the Unix job, define a full-path script file name. For the PC job, define a full-path executable file name.

You can set a character string of 1 to 511 bytes.

If you want to use a double quotation mark (") or a hash mark (#) as a character, prefix the character by #. That is, use #" instead of " and use ## instead of #.

You can specify a macro variable.

`prm="parameter" ;`

Define a parameter for the target file.

You can set a character string of 1 to 1,023 bytes.

If you want to use a double quotation mark (") or a hash mark (#) as a character, prefix the character by #. That is, use #" instead of " and use ## instead of #.

You can specify a macro variable.

`env="environment-variable" ;`

Define an environment variable.

You can set a character string of 1 to 20,479 bytes.

If you want to use a double quotation mark (") or a hash mark (#) as a character, prefix the character by #. That is, use #" instead of " and use ## instead of #.

For notes on defining environment variables, see [A. Notes on Defining Environment Variables and an Environment Variable File](#).

You can specify a macro variable.

`so="standard-output-file-name" ;`

Define a full-path standard output file name.

You can set a character string of 1 to 511 bytes.

If you want to use a double quotation mark (") or a hash mark (#) as a character, prefix the character by #. That is, use #" instead of " and use ## instead of #.

By specifying `$JP1AJS2_JPQSTDOUTTEMP$`, you can output the standard output file as a temporary file.

You can specify a macro variable.

`se="standard-error-output-file-name" ;`

Define a full-path standard error output file name.

You can set a character string of 1 to 511 bytes.

If you want to use a double quotation mark (") or a hash mark (#) as a character, prefix the character by #. That is, use #" instead of " and use ## instead of #.

You can specify a macro variable.

`etm=n ;`

Define the time-out period using the relative minutes from the start time.

You can set 1 to 1,440 minutes.

`fd=time-required-for-execution ;`

Define the time-required-for-execution within which the job is expected to be terminated.

You can specify a decimal value between 1 and 1,440 (minutes).

`pr=n ;`

Define the priority of job execution.

You can set 1 to 5. The lowest priority of execution is 1, while the highest priority is 5. The default depends on the definition of upper-level jobnet. If this parameter is not specified, and if the `pr` parameter and the `ni` parameter

of all upper-level jobnets of the job are not specified, the priority of the job is assumed to be the value specified for the `DEFAULTPRIORITY` environment setting parameter (If no value is specified for the `DEFAULTPRIORITY` environment setting parameter, then the priority is assumed to be 1). For details about the `DEFAULTPRIORITY` environment setting parameter, see *20.4.2(108) DEFAULTPRIORITY* in the *JP1/Automatic Job Management System 3 Configuration Guide*.

```
ex="job-execution-agent-host-name" ;
```

Define the name of the JP1/AJS3 - Agent host to execute a job.

You can set a character string of 1 to 255 bytes.

If you want to use a double quotation mark (") or a hash mark (#) as a character, prefix the character by #. That is, use # " instead of " and use ## instead of #.

You can specify a macro variable.

```
un="execution-user-name" ;
```

To use the JP1/AJS3 - Agent host to execute a job, define the user name of the user responsible for job execution.

You can set a character string of 1 to 63 bytes. The user name cannot contain any space characters.

If you want to use a double quotation mark (") or a hash mark (#) as a character, prefix the character by #. That is, use # " instead of " and use ## instead of #.

You can specify a macro variable.

```
jd={ nm | ab | cod | mdf | exf } ;
```

Define the type of end judgment. The default is `cod`.

If you specify a value other than `cod`, you cannot specify `y` for the `abr` parameter. If you specify `y`, the KAVS0674-E message is output, and the unit cannot be created.

- `nm`: Always assumes a normal end.
- `ab`: Always assumes an abnormal end.
- `cod`: Normal end if the return code is below a specified value.
- `mdf`: Normal end if the file is refreshed.
- `exf`: Normal end if a file is created.

```
wth=n ;
```

Define the threshold for the end with warning.

You can set 0 to 2,147, 483, 647.

```
tho=n ;
```

Define the threshold for the abnormal end.

You can set 0 to 2,147, 483, 647. The default is 0.

```
jdf="end-judgment-file-name" ;
```

Define a full-path end judgment file name.

You can set a character string of 1 to 511 bytes.

If you want to use a double quotation mark (") or a hash mark (#) as a character, prefix the character by #. That is, use # " instead of " and use ## instead of #.

You can specify a macro variable.

```
abr={ y | n } ;
```

Define whether retrying on an abnormal end is enabled. If you omit this option, the system assumes `n`.

You can specify `y` only when you specify `cod` for the `jd` parameter.

- `y`: Automatic retries are performed if an abnormal end occurs.

- n: Automatic retries are not performed if an abnormal end occurs.

`rjs=lower-limit-of-return-codes-to-be-retried-automatically;`

Define the lower limit of the return codes to be retried automatically when automatic retrying is performed for an abnormal end.

You can define the lower limit only when you specify `y` for the `abr` parameter.

You can specify a value from 1 to 4,294,967,295. If you specify a value equal to or smaller than the abnormal threshold and a value greater than the upper limit of the return codes to be retried automatically, the KAVS0668-E message is output, and the unit cannot be created.

If you omit this option, the system assumes *abnormal-threshold* + 1 when the job is executed.

`rje=upper-limit-of-return-codes-to-be-retried-automatically;`

Define the upper limit of the return codes to be retried automatically if automatic retrying is performed for an abnormal end.

You can define the upper limit only when you specify `y` for the `abr` parameter.

You can specify a value from 1 to 4,294,967,295. If you specify a value equal to or smaller than the abnormal threshold and a value smaller than the lower limit of the return codes to be retried automatically, the KAVS0668-E message is output, and unit creation fails.

If you omit this option, the system assumes the maximum value (4,294,967,295) when the job is executed.

`rec=maximum-number-of-retry-executions;`

Define the maximum number of retry executions when automatic retrying is performed for an abnormal end.

You can specify this parameter only when you specify `y` for the `abr` parameter.

You can specify a value from 1 to 12 (times). If you omit this option, the system assumes 1.

`rei=retry-interval;`

Define the retry interval when automatic retrying is performed for an abnormal end.

You can specify this parameter only when you specify `y` for the `abr` parameter.

You can specify a value from 1 to 10 (minutes). If you omit this option, the system assumes 1.

`ha={y|n};`

Define whether to suspend job execution. The default is `n`.

- `y`: Suspends job execution.
- `n`: Does not suspend job execution.

`eu={ent|def};`

Define the JP1 user who executes the job. The default is `ent`.

- `ent`: The JP1 user who registered the jobnet executes the job.
- `def`: The JP1 user who owns the job executes the job.

`wkp="work-path-name";`

Define the work path name using a full path name.

You can set a character string of 1 to 511 bytes.

For a work path name including a double quotation mark (") or a hash mark (#), prefix the character by #. That is, use # " instead of " and use ## instead of #.

This cannot be specified in custom PC jobs.

You can specify a macro variable.

`ev="environmental-variable-file-name";`

Define the environmental variable file name for the agent host.

You can set a character string of 1 to 511 bytes. You can use either an absolute path or a relative path to specify the file name. If you specify a relative path, the system assumes it to be a relative path from the work path for job execution.

For a file name including a double quotation mark (") or a hash mark (#), prefix the character by #. That is, use #" instead of " and use ## instead of #.

This cannot be specified in custom PC jobs.

You can specify a macro variable.

For notes on defining environment variables, see *A. Notes on Defining Environment Variables and an Environment Variable File*.

```
si="standard-input-file-name";
```

Define the name of a standard input file on the agent host executing the job.

You can set a character string of 1 to 511 bytes. You can use either an absolute path or a relative path to specify the file name. If you specify a relative path, the system assumes it to be a relative path from the work path for job execution.

For a file name including a double quotation mark (") or a hash mark (#), prefix the character by #. That is, use #" instead of " and use ## instead of #.

This cannot be specified in custom PC jobs.

You can specify a macro variable.

```
soa={new|add};
```

Define the append option for a standard output file name. The default is `new`. This parameter is invalid if the `so` parameter does not specify the standard output file name.

This cannot be specified in custom PC jobs.

- `new`: Creates a new file.
- `add`: Adds information to an existing file.

```
sea={new|add};
```

Define the append option for a standard error output file name. The default is `new`. This parameter is invalid if the `se` parameter does not specify the standard error output file name.

This cannot be specified in custom PC jobs.

- `new`: Creates a new file.
- `add`: Adds information to an existing file.

```
ts1="transfer-source-file-name-1";
```

Define the name of a transfer source file using a full path name.

You can set a character string of 1 to 511 bytes.

For a file name including a double quotation mark (") or a hash mark (#), prefix the character by #. That is, use #" instead of " and use ## instead of #.

This cannot be specified in custom PC jobs.

You can specify a macro variable.

```
td1="transfer-destination-file-name-1";
```

Define the name of a transfer destination file to be transferred to the agent host.

You can set a character string of 1 to 511 bytes.

The default is the `$JP1AJS2_JPQTEMPxx$` variable, where the `xx` part means the transfer file's number ranging from 01 to 04.

With this variable specified in the `sc` or `prm` parameter, you can execute the job without having to be aware of the transfer destination file name.

For a file name including a double quotation mark (") or a hash mark (#), prefix the character by #. That is, use #" instead of " and use ## instead of #.

This cannot be specified in custom PC jobs.

You can specify a macro variable.

```
top1={sav|del};
```

Define the option to automatically delete the transfer destination file.

- sav: Saves the file.
- del: Deletes the file.

If you specify the transfer source file name and the transfer destination file name without specifying this parameter, the system assumes sav.

If you specify the transfer source file name without specifying this parameter, the system assumes del.

This cannot be specified in custom PC jobs.

```
ts2="transfer-source-file-name-2";
```

Define the name of a transfer source file using a full path name.

1 to 511 bytes of characters can be specified.

For a file name including a double quotation mark (") or a cast character (#), prefix the character by #. That is, use #" instead of " and use ## instead of #.

This cannot be specified in custom PC jobs.

You can specify a macro variable.

```
td2="transfer-destination-file-name-2";
```

Define the name of a transfer destination file to be transferred to the agent host.

1 to 511 bytes of characters can be specified.

The default is the \$JP1AJS2_JPQTEMPxx\$ variable, where the xx part means the transfer file's number ranging from 01 to 04.

With this variable specified in the sc or prm parameter, you can execute the job without having to be aware of the transfer destination file name.

For a file name including a double quotation mark (") or a hash mark (#), prefix the character by #. That is, use #" instead of " and use ## instead of #.

This cannot be specified in custom PC jobs.

You can specify a macro variable.

```
top2={sav|del};
```

Define the option to automatically delete the transfer destination file.

- sav: Saves the file.
- del: Deletes the file.

If you specify the transfer source file name and the transfer destination file name without specifying this parameter, the system assumes sav.

If you specify a transfer source file name without specifying a transfer destination file name and this parameter, this parameter defaults to del.

This cannot be specified in custom PC jobs.

```
ts3="transfer-source-file-name-3";
```

Define the name of a transfer source file using a full path name.

1 to 511 bytes of characters can be specified.

For a file name including a double quotation mark (") or a hash mark (#), prefix the character by #. That is, use #" instead of " and use ## instead of #.

This cannot be specified in custom PC jobs.

You can specify a macro variable.

```
td3="transfer-destination-file-name-3";
```

Define the name of a transfer destination file to be transferred to the agent host.

1 to 511 bytes of characters can be specified.

The default is the \$JP1AJS2_JPQTEMPxx\$ variable, where the xx part means the transfer file's number ranging from 01 to 04.

With this variable specified in the sc or prm parameter, you can execute the job without having to be aware of the transfer destination file name.

For a file name including a double quotation mark (") or a cast character (#), prefix the character by #. That is, use #" instead of " and use ## instead of #.

This cannot be specified in custom PC jobs.

You can specify a macro variable.

```
top3={sav|del};
```

Define the option to automatically delete the transfer destination file.

- sav: Saves the file.
- del: Deletes the file.

If you specify the transfer source file name and the transfer destination file name without specifying this parameter, the system assumes sav.

If you specify a transfer source file name without specifying a transfer destination file name and this parameter, this parameter defaults to del.

This cannot be specified in custom PC jobs.

```
ts4="transfer-source-file-name-4";
```

Define the name of a transfer source file using a full path name.

1 to 511 bytes of characters can be specified.

For a file name including a double quotation mark (") or a cast character (#), prefix the character by #. That is, use #" instead of " and use ## instead of #.

This cannot be specified in custom PC jobs.

You can specify a macro variable.

```
td4="transfer-destination-file-name-4";
```

Define the name of a transfer destination file to be transferred to the agent host.

1 to 511 bytes of characters can be specified.

The default is the \$JP1AJS2_JPQTEMPxx\$ variable, where the xx part means the transfer file's number ranging from 01 to 04.

With this variable specified in the sc or prm parameter, you can execute the job without having to be aware of the transfer destination file name.

For a file name including a double quotation mark (") or a cast character (#), prefix the character by #. That is, use #" instead of " and use ## instead of #.

This cannot be specified in custom PC jobs.

You can specify a macro variable.

`top4={sav|del};`

Define the option to automatically delete the transfer destination file.

- `sav`: Saves the file.
- `del`: Deletes the file.

If you specify the transfer source file name and the transfer destination file name without specifying this parameter, the system assumes `sav`.

If you specify a transfer source file name without specifying a transfer destination file name and this parameter, this parameter defaults to `del`.

This cannot be specified in custom PC jobs.

`mm={and|or};`

Define the wait method with respect to the specified units whose ends are being waited for.

The default is `and`.

- `and`: Start executing at completion of all units whose ends are being waited for.
- `or`: Start executing at completion of one of the units whose ends are being waited for.

`nmg={y|n};`

Define the behavior when there are no generations of the root jobnet for the specified unit whose end is being waited for.

The default is `n`.

- `y`: Start executing.
- `n`: Do not start executing.

`eun=name-of-the-unit-whose-end-is-being-waited-for;`

Define the full-path name of a unit whose end is being waited for.

To specify multiple units, repeat the parameter. You can specify a maximum of 32 units.

You can use a character string of 1 to 930 bytes as the unit name.

`ega={exec|execdeffer|none};`

Specify the behavior when a jobnet with start conditions is specified as the jobnet whose end is being waited for and the execution generation ends abnormally.

If you omit this option, the system assumes `none`.

- `exec`: Start executing.
- `execdeffer`: Do not start executing. However, if the execution generation is in the *Skipped so not exe.* status, start executing.
- `none`: Do not start executing.

`uem={y|n};`

Specify the behavior when a jobnet with start conditions is specified as the jobnet whose end is being waited for and the monitoring generation is in the *Unmonitored + Ended* status.

If you omit this option, the system assumes `n`.

- `y`: Start executing.
- `n`: Do not start executing.

5.2.25 Passing information setting job definition

This paragraph explains how to specify a definition for a passing information setting job.

The following gives the format and parameters for a passing information setting job definition.

Format

```
ty={cpj|rcpj};
cty="AJSVAR";
sc="$JP1AJS2_JPOEXEPATH$/jppqpinfoset";
prm="-o output-variable-1 [-o output-variable-2...]";
env="AJS2SO_GLOBMACFILE=?AJS2SO_GLOBMACFILE?";
env="AJS2SO_STDOUTFILE=?AJS2SO_STDOUTFILE?";
env="AJS2SO_RE_output-variable-1=regular-expression-1";
    [env="AJS2SO_RE_output-variable-2=regular-expression-2";...]
[wth=n;]
[tho=n;]
[mm={and|or};]
[nmg={y|n};]
[eun=name-of-the-unit-whose-end-is-being-waited-for;]
[ega={exec|execdefer|none};]
[uem={y|n};]
```

Parameters

```
ty={cpj|rcpj};
```

Specify `cpj` as a general rule. If you are defining the passing information setting job as a recovery job, specify `rcpj`.

```
cty="AJSVAR";
```

The value of this parameter is fixed.

```
sc="$JP1AJS2_JPOEXEPATH$/jppqpinfoset";
```

The value of this parameter is fixed.

```
prm="-o output-variable-1 [-o output-variable-2...]";
```

Specify each output variable by macro variable name, omitting the first five characters (?AJS2) and the last character (?). For example, to output information to the macro variable ?AJS2VAR?, specify `-o VAR`.

You can set a character string of 1 to 1,023 bytes in each output variable. A maximum of 32 output variables can be specified.

```
env="AJS2SO_GLOBMACFILE=?AJS2SO_GLOBMACFILE?";
```

The value of this parameter is fixed.

```
env="AJS2SO_STDOUTFILE=?AJS2SO_STDOUTFILE?";
```

The value of this parameter is fixed.

```
env="AJS2SO_RE_output-variable-1=regular-expression-1"; [env="AJS2SO_RE_output-variable-2=regular-expression-2"; ...]
```

Define a regular expression for each of the output variables you specified in `prm`. In `output-variable-x`, specify the same value as specified in `output-variable-x` in `prm`.

The results extracted by the regular expressions you specify here are set as the values of the macro variables corresponding to the output variables.

```
wth=n;
```

Define the threshold for the end with warning. You can set 0 to 2,147,483,647.

tho=n;

Define the threshold for the abnormal end.

You can set 0 to 2,147,483,647. The default is 0.

mm={and|or};

Define the wait method with respect to the specified units whose ends are being waited for.

The default is and.

- and: Start executing at completion of all units whose ends are being waited for.
- or: Start executing at completion of one of the units whose ends are being waited for.

nmg={y|n};

Define the behavior when there are no generations of the root jobnet for the specified unit whose end is being waited for.

The default is n.

- y: Start executing.
- n: Do not start executing.

eun=*name-of-the-unit-whose-end-is-being-waited-for*;

Define the full-path name of a unit whose end is being waited for.

To specify multiple units, repeat the parameter. You can specify a maximum of 32 units.

You can use a character string of 1 to 930 bytes as the unit name.

ega={exec|execdefer|none};

Specify the behavior when a jobnet with start conditions is specified as the jobnet whose end is being waited for and the execution generation ends abnormally.

If you omit this option, the system assumes none.

- exec: Start executing.
- execdefer: Do not start executing. However, if the execution generation is in the *Skipped so not exe.* status, start executing.
- none: Do not start executing.

uem={y|n};

Specify the behavior when a jobnet with start conditions is specified as the jobnet whose end is being waited for and the monitoring generation is in the *Unmonitored + Ended* status.

If you omit this option, the system assumes n.

- y: Start executing.
- n: Do not start executing.

5.2.26 Flexible job definition

This paragraph explains how to specify a definition for a flexible job.

The following gives the format and parameters for a flexible job definition.

Format

```
[ex="relay-agent-name";]  
da="destination-or-broadcast-agent";
```

```
[fxg={none|sync|async};]
sc="name-of-the-file-to-be-executed-on-the-agent-host";
[prm="parameter";]
[env="environment-variable"];...
[jd={nm|ab|cod|mdf|exf};]
[wth=n;]
[tho=n;]
[jdf="end-judgment-file-name";]
[abr={y|n};]
[rjs=lower-limit-of-return-codes-to-be-retried-automatically;]
[rje=upper-limit-of-return-codes-to-be-retried-automatically;]
[rec=maximum-number-of-retry-executions;]
[rei=retry-interval;]
[ha={y|n};]
[eu={ent|def};]
[mm={and|or};]
[nmg={y|n};]
[eun=name-of-the-unit-whose-end-is-being-waited-for;]
[ega={exec|execdefer|none};]
[uem={y|n};]
```

Parameters

`ex="relay-agent-name";`

Define the name of the execution agent or execution agent group to be the relay agent. You do not have to specify this parameter if relay is not performed.

You can set a character string of 1 to 255 bytes.

If you want to use a double quotation mark (") or a hash mark (#) as a character, prefix the character by #. That is, use #" instead of " and use ## instead of #.

The Relay agent name can contain macro variables. Set *macro-variable-name* as a character string of no more than 64 bytes, using the format ?AJS2xxxx?. In the xxxxx part, you can use uppercase alphabetic characters (A to Z), numerals (0 to 9), and periods (.).

`da="destination-or-broadcast-agent";`

Define the host name, IP address, or DNS name of the destination to which execution of the flexible job is to be requested. `jp1hosts` information or `jp1hosts2` information is not referenced.

When broadcasting is used, the destination of the execution request is a broadcast agent.

When a load balancer is used without broadcasting, the destination of the execution request is the load balancer.

When neither broadcasting nor a load balancer is used, the destination of the execution request is the agent host on which the flexible job is to be executed.

You can set a character string of 1 to 128 bytes. Specifying this parameter is mandatory.

If you want to use a double quotation mark (") or a hash mark (#) as a character, prefix the character by #. That is, use #" instead of " and use ## instead of #.

The Destination can contain macro variables. Set *macro-variable-name* as a character string of no more than 64 bytes, using the format ?AJS2xxxx?. In the xxxxx part, you can use uppercase alphabetic characters (A to Z), numerals (0 to 9), and periods (.).

`fxg={none|sync|async};`

Specify the broadcast execution method for a flexible job. If you omit this option, the system assumes `none`.

- `none`: Executes a normal flexible job without performing broadcast execution.
- `sync`: Performs broadcast execution in synchronous mode.
- `async`: Performs broadcast execution in asynchronous mode.

```
sc="name-of-the-file-to-be-executed-on-the-agent-host" ;
```

Define the name of the file, on the agent host, to be executed.

You can set a character string of 1 to 511 bytes. Specify the file name by using the absolute path. If the file to be executed is located directly under the path specified by the environment variable `PATH`, you can specify the file name only. Specifying this parameter is mandatory.

If you want to use a double quotation mark (") or a hash mark (#) as a character, prefix the character by #. That is, use # " instead of " and use ## instead of #.

You can specify a macro variable for the name of the file (to be executed on the agent host). Set *macro-variable-name* as a character string of no more than 64 bytes, using the format `?AJS2xxxxx?`. In the `xxxxx` part, you can use uppercase alphabetic characters (A to Z), numerals (0 to 9), and periods (.).

```
prm="parameter" ;
```

Define the parameter to be used for the file (to be executed on the agent host).

You can set a character string of 1 to 1,023 bytes.

If you want to use a double quotation mark (") or a hash mark (#) as a character, prefix the character by #. That is, use # " instead of " and use ## instead of #.

The parameter can contain macro variables. Set *macro-variable-name* as a character string of no more than 64 bytes, using the format `?AJS2xxxxx?`. In the `xxxxx` part, you can use uppercase alphabetic characters (A to Z), numerals (0 to 9), and periods (.).

```
env="environment-variable" ;
```

While a job is being executed, the environment variables set at job execution, the system environment variables, or the environment variables set in the local login script for the execution user (OS user) are enabled. You can add new variables and then execute the job. Define the environment variables to be added in the format of *environment-variable-name=value*.

You can set a character string of 1 to 10,240 bytes. If you have specified multiple `env` parameters, you can specify environment variables up to 10,240 bytes in total.

If you want to use a double quotation mark (") or a hash mark (#) as a character, prefix the character by #. That is, use # " instead of " and use ## instead of #.

The environment variable can contain macro variables. Set *macro-variable-name* as a character string of no more than 64 bytes, using the format `?AJS2xxxxx?`. In the `xxxxx` part, you can use uppercase alphabetic characters (A to Z), numerals (0 to 9), and periods (.).

For details about the environment variables to be set at job execution, see [1.4.2 Environment variables set when a job is executed from JPI/AJS3](#).

For notes on defining environment variables, see [A. Notes on Defining Environment Variables and an Environment Variable File](#).

```
jd={nm|ab|cod|mdf|exf} ;
```

Define the type of end judgment. The default is `cod`.

If you specify a value other than `cod`, you cannot specify the `rjs`, `rje`, `rec`, and `rei` parameters. In addition, you cannot specify `y` for the `abr` parameter. If you specify `y`, unit creation fails.

- `nm`: Always assumes a normal end.
- `ab`: Always assumes an abnormal end.
- `cod`: Normal end if the return code is below a set value
- `mdf`: Normal end if the file is refreshed during start and end of job process execution on the destination agent
- `exf`: Normal end if the file is refreshed at the end of job process execution on the destination agent

`wth=n;`

Define the warning threshold.

You can set 0 to 2,147,483,647.

`tho=n;`

Define the abnormal threshold.

You can set 0 to 2,147,483,647. The default is 0.

`jd f="end-judgment-file-name";`

Define an end judgment file name on the agent host for flexible job execution.

You can set a character string of 1 to 511 bytes. Specify the file name by using the absolute path.

If you want to use a double quotation mark (") or a hash mark (#) as a character, prefix the character by #. That is, use #" instead of " and use ## instead of #.

The end judgment file name can contain macro variables. Set *macro-variable-name* as a character string of no more than 64 bytes, using the format ?AJS2xxxx?. In the xxxxx part, you can use uppercase alphabetic characters (A to Z), numerals (0 to 9), and periods (.).

`abr={y|n};`

Define whether retrying on an abnormal end is enabled. If you omit this option, the system assumes n.

You can specify y only when you specify `cod` for the `jd` parameter.

- y: Automatic retries are performed if an abnormal end occurs.
- n: Automatic retries are not performed if an abnormal end occurs.

`rjs=lower-limit-of-return-codes-to-be-retried-automatically;`

Define the lower limit of the return codes to be retried automatically if an abnormal end occurs.

This option can be specified only if automatic retrying is performed when an abnormal end occurs (y is specified for the `abr` parameter).

You can specify a value from 1 to 4,294,967,295. If you specify a value equal to or smaller than the abnormal threshold (the `tho` parameter) and a value greater than the upper limit on return codes to be automatically retried (the `rie` parameter), unit creation fails.

If this option is omitted, a lower limit for the return codes to be retried automatically is not defined, and *abnormal-threshold* + 1 is assumed when the job is executed.

`rje=upper-limit-of-return-codes-to-be-retried-automatically;`

Define the upper limit of the return codes to be retried automatically if an abnormal end occurs.

This option can be specified only if automatic retrying is performed when an abnormal end occurs (y is specified for the `abr` parameter).

You can specify a value from 1 to 4,294,967,295. If you specify a value equal to or smaller than the abnormal threshold (the `tho` parameter) and a value smaller than the lower limit of the return codes to be retried automatically (the `ris` parameter), unit creation fails.

If this option is omitted, an upper limit of the return codes to be automatically retried is not defined, and the maximum value (4,294,967,295) is assumed when the job is executed.

`rec=maximum-number-of-retry-executions;`

Define the maximum number of retry executions only when automatic retry is performed for an abnormal end (y is specified for the `abr` parameter).

You can specify a value from 1 to 12 (times). If you omit this option, the system assumes 1.

`rei=retry-interval;`

Define the retry interval only when automatic retrying is performed for an abnormal end (`y` is specified for the `abr` parameter).

You can specify a value from 1 to 10 (minutes). If you omit this option, the system assumes 1.

`ha={y|n};`

Define whether to suspend job execution. The default is `n`.

- `y`: Suspends job execution.
- `n`: Does not suspend job execution.

`eu={ent|def};`

Define the JP1 user who executes the job. The default is `ent`.

- `ent`: The JP1 user who registered the jobnet executes the job.
- `def`: The JP1 user who owns the job executes the job.

`mm={and|or};`

Define the wait method with respect to the specified units whose ends are being waited for. The default is `and`.

- `and`: Start executing at completion of all units whose ends are being waited for.
- `or`: Start executing at completion of one of the units whose ends are being waited for.

`nmg={y|n};`

Define the behavior when there are no generations of the root jobnet for the specified unit whose end is being waited for.

The default is `n`.

- `y`: Start executing.
- `n`: Do not start executing.

`eun=name-of-the-unit-whose-end-is-being-waited-for;`

Define the full-path name of a unit whose end is being waited for.

To specify multiple units, repeat the parameter. You can specify a maximum of 32 units.

You can use a character string of 1 to 930 bytes as the unit name.

`ega={exec|execdeffer|none};`

Specify the behavior when a jobnet with start conditions is specified as the jobnet whose end is being waited for and the execution generation ends abnormally.

If you omit this option, the system assumes `none`.

- `exec`: Start executing.
- `execdeffer`: Do not start executing. However, if the execution generation is in the *Skipped so not exe.* status, start executing.
- `none`: Do not start executing.

`uem={y|n};`

Specify the behavior when a jobnet with start conditions is specified as the jobnet whose end is being waited for and the monitoring generation is in the *Unmonitored + Ended* status.

If you omit this option, the system assumes `n`.

- `y`: Start executing.

- n: Do not start executing.

5.2.27 HTTP Connection job definition

This paragraph explains how to specify a definition for an HTTP Connection job.

The following gives the format and parameters for an HTTP Connection job definition.

Format

```
htcfl="connection-configuration-file-name";
[htknd={GET|POST|PUT|DELETE};]
[htexm={y|n};]
[htrqf="transmission-information-file-name";]
[htrq="transmission-information-file-name-(URL-parameter)";]
[htrqm="transmission-information-file-name-(message-body)";]
htstf="statuses-store-file-name";
[htspt={diff|same};]
htrhf="received-header-store-file-name";
[htrbf="received-body-store-file-name";]
[htcdm=return-code-1:HTTP-status-code-1,[HTTP-status-code-2...];]
[so="standard-output-file-name";]
[se="standard-error-output-file-name";]
[etm=n;]
[fd=time-required-for-execution;]
[pr=n;]
[ex="execution-agent-name";]
[un="target-user-name";]
[jd={nm|ab|cod|mdf|exf};]
[wth=n;]
[tho=n;]
[jdf="end-judgment-file-name";]
[abr={y|n};]
[rjs=lower-limit-of-return-codes-to-be-retried-automatically;]
[rje=upper-limit-of-return-codes-to-be-retried-automatically;]
[rec=maximum-number-of-retry-executions;]
[rei=retry-interval;]
[ha={y|n};]
[eu={ent|def};]
[mm={and|or};]
[nmg={y|n};]
[eun=name-of-the-unit-whose-end-is-being-waited-for;]
[ega={exec|execdeffer|none};]
[uem={y|n};]
```

Parameters

`htcfl="connection-configuration-file-name";`

Define the name of the connection configuration file on the agent host. In this file, connection information for HTTP connection is defined.

You can set a character string of 1 to 511 bytes.

Specify the connection configuration file name by using the absolute path.

If you want to use a double quotation mark (") or a hash mark (#) as a character, prefix the character by #. That is, use #" instead of " and use ## instead of #.

You can specify a macro variable for the connection configuration file name. Set *macro-variable-name* as a character string of no more than 64 bytes, using the format `?AJS2xxxx?`. In the *xxxxx* part, you can use uppercase alphabetic characters (A to Z), numerals (0 to 9), and periods (.).

```
htknd={GET|POST|PUT|DELETE};
```

Define the request type (HTTP method) used for HTTP communication. The default is GET.

- GET
- POST
- PUT
- DELETE

```
htexm={y|n};
```

Define whether to use extended mode. You can specify this parameter if the versions of JP1/AJS3 - Manager and JP1/AJS3 - Agent are 12-50 or later.

The default is n.

- y
Extended mode is used. The contents of both the transmission information file (URL parameter) and the transmission information file (message body) are sent as an HTTP request.
- n
Extended mode is not used. The contents of only the transmission information file are sent as an HTTP request.

```
htrqf="transmission-information-file-name";
```

Define the name of the transmission information file on the agent host. In this file, information to be sent as an HTTP request is defined.

You can set a character string of 1 to 511 bytes.

Specify the transmission information file name by using the absolute path.

If you want to use a double quotation mark (") or a hash mark (#) as a character, prefix the character by #. That is, use #" instead of " and use ## instead of #.

You can specify a macro variable for the transmission information file name. Set *macro-variable-name* as a character string of no more than 64 bytes, using the format `?AJS2xxxx?`. In the *xxxxx* part, you can use uppercase alphabetic characters (A to Z), numerals (0 to 9), and periods (.).

Whether the contents of the transmission information file are to be sent as a URL parameter or a message body depends on the request type of the HTTP request. If you want to specify the type of information to be sent independently of the request type, we recommend that you use the following specification: Specify *y* for the *htexm* parameter, in addition to using `htrqu="transmission-information-file-(URL-parameter)";` and `htrqm="transmission-information-file-(message-body)";`.

The specification of this parameter is overridden if *y* is specified for the *htexm* parameter.

```
htrqu="transmission-information-file-name-(URL-parameter)";
```

Define the name of the transmission information file (URL parameter) that exists on the agent host and contains the information to be sent as the URL parameter of an HTTP request. You can specify this parameter if extended mode is used when the versions of JP1/AJS3 - Manager and JP1/AJS3 - Agent are 12-50 or later.

You can set a character string of 1 to 511 bytes.

Specify the absolute path of the transmission information file (URL parameter).

If the name of the transmission information file (URL parameter) includes a double quotation mark (") or hash mark (#), cast the character by prefixing it with a cast character (#). To cast a quotation mark ("), specify #".

To cast a hash mark (#), specify ##.

You can specify a macro variable for the transmission information file name (URL parameter). Set *macro-variable-name* as a character string of no more than 64 bytes, using the format ?AJS2xxxx?. In the *xxxxx* part, you can use uppercase alphabetic characters (A to Z), numerals (0 to 9), and periods (.).

The specification of this parameter is overridden if *n* is specified for the `htexm` parameter.

```
htreqm="transmission-information-file-name-(message-body)";
```

Define the name of the transmission information file (message body) that exists on the agent host and contains the information to be sent as the message body of an HTTP request. You can specify this parameter if extended mode is used when the versions of JP1/AJS3 - Manager and JP1/AJS3 - Agent are 12-50 or later.

You can set a character string of 1 to 511 bytes.

Specify the absolute path of the transmission information file (message body).

If the name of the transmission information file (message body) includes a double quotation mark (") or hash mark (#), cast the character by prefixing it with a cast character (#). To cast a quotation mark ("), specify #". To cast a hash mark (#), specify ##.

You can specify a macro variable for the transmission information file name (message body). Set *macro-variable-name* as a character string of no more than 64 bytes, using the format ?AJS2xxxx?. In the *xxxxx* part, you can use uppercase alphabetic characters (A to Z), numerals (0 to 9), and periods (.).

The specification of this parameter is overridden if *n* is specified for the `htexm` parameter.

```
htstf="statuses-store-file-name";
```

Define the statuses store file name that is to be created on the agent host in order to store the HTTP status information contained in the HTTP response.

You can set a character string of 1 to 511 bytes.

Specify the statuses store file name by using the absolute path.

If you want to use a double quotation mark (") or a hash mark (#) as a character, prefix the character by #. That is, use #" instead of " and use ## instead of #.

You can specify a macro variable for the statuses store file name. Set *macro-variable-name* as a character string of no more than 64 bytes, using the format ?AJS2xxxx?. In the *xxxxx* part, you can use uppercase alphabetic characters (A to Z), numerals (0 to 9), and periods (.).

```
htspt={diff|same};
```

Define whether the HTTP header and HTTP body that are received as an HTTP response are to be output to separate files, or to the same file. The default is `diff`.

- `diff`
The header of the received data is written in the received header file. The body is written in the received body file.
- `same`
The received data, including the header and body, is written to the received header file only.

```
htrhf="received-header-store-file-name";
```

Define the received header store file name that is to be created on the agent host in order to store the information of the HTTP header received as an HTTP response.

You can set a character string of 1 to 511 bytes.

Specify the received header store file name by using the absolute path.

If the received header store file name contains a space character, enclose the received header store file name by double quotation marks (").

If you want to use a double quotation mark (") or a hash mark (#) as a character, prefix the character by #. That is, use #" instead of " and use ## instead of #.

You can specify a macro variable for the received header store file name. Set *macro-variable-name* as a character string of no more than 64 bytes, using the format ?AJS2xxxx?. In the *xxxxx* part, you can use uppercase alphabetic characters (A to Z), numerals (0 to 9), and periods (.).

```
htrbf="received-body-store-file-name";
```

Define the received body store file name that is to be created on the agent host in order to store the information of the HTTP body received as an HTTP response.

You can set a character string of 1 to 511 bytes.

Specify the received body store file name by using the absolute path.

If the received body store file name contains a space character, enclose the received body store file name by double quotation marks (").

If you want to use a double quotation mark (") or a hash mark (#) as a character, prefix the character by #. That is, use #" instead of " and use ## instead of #.

You can specify a macro variable for the received body store file name. Set *macro-variable-name* as a character string of no more than 64 bytes, using the format ?AJS2xxxx?. In the *xxxxx* part, you can use uppercase alphabetic characters (A to Z), numerals (0 to 9), and periods (.).

If you define *diff* for *htspt*={*diff*|*same*};, you cannot omit *htrbf*="received-body-store-file-name";. If you select *same*, the value defined in *htrbf*="received-body-store-file-name"; is ignored.

```
htcdm=return-code-1:HTTP-status-code-1, [HTTP-status-code-2...];
```

Specify a job return code for each HTTP status code. You can specify multiple instances of this parameter. To specify multiple job return codes, use the following specification format: *htcdm*=*return-code-1*:*HTTP-status-code-1* *htcdm*=*return-code-2*:*HTTP-status-code-2* ...

You can set a character string of 1 to 511 bytes. For a job return code, you can specify a value in the range from 0 to 9. For an HTTP status code, you can specify a value in the range from 100 to 999. You can use only numeric characters (0 to 9) and colons (:).

```
so="standard-output-file-name";
```

Define a file name for standard output on the agent host where the job is executed.

You can set a character string of 1 to 511 bytes. We recommend that you specify the file name by using the absolute path. Assume that you specify the file name by using the relative path when the HTTP connection job is executed by Windows. In such a case, the path will be the relative path from the work directory used when the agent process (set in the environment settings of the agent) is executed. If the HTTP connection job is executed by Linux, the path will be the relative path from the home directory for the execution user. If the home directory has not been defined, the path will be the relative path from the root directory (/).

If you want to use a double quotation mark (") or a hash mark (#) as a character, prefix the character by #. That is, use #" instead of " and use ## instead of #.

You can specify a macro variable for the standard output file name. Set *macro-variable-name* as a character string of no more than 64 bytes, using the format ?AJS2xxxx?. In the *xxxxx* part, you can use uppercase alphabetic characters (A to Z), numerals (0 to 9), and periods (.).

If you specify \$JP1AJS2_JPQSTDOUTTEMP\$, the standard output file is output to a temporary file.

```
se="standard-error-output-file-name";
```

Define a file name for standard error output on the agent host where the job is executed.

You can set a character string of 1 to 511 bytes. We recommend that you specify the file name by using the absolute path. Assume that you specify the file name by using the relative path when the HTTP connection job is executed by Windows. In such a case, the path will be the relative path from the work directory used when the agent process (set in the environment settings of the agent) is executed. If the HTTP connection job is executed by Linux, the path will be the relative path from the home directory for the execution user. If the home directory has not been defined, the path will be the relative path from the root directory (/).

If you want to use a double quotation mark (") or a hash mark (#) as a character, prefix the character by #. That is, use #" instead of " and use ## instead of #.

You can specify a macro variable for the standard error output file name. Set *macro-variable-name* as a character string of no more than 64 bytes, using the format ?AJS2xxxx?. In the xxxxx part, you can use uppercase alphabetic characters (A to Z), numerals (0 to 9), and periods (.).

`etm=n;`

Define the time-out period using the relative minutes from the start time.

You can specify a decimal value between 1 and 1,440 (minutes).

`fd=time-required-for-execution;`

Define the time-required-for-execution within which the job is expected to be terminated.

You can specify a decimal value between 1 and 1,440 (minutes).

`pr=n;`

Define the priority of job execution.

You can set 1 to 5. The lowest priority of execution is 1, while the highest priority is 5. The default value depends on the definition of the upper-level jobnets. If this parameter is not specified, and if the `pr` parameter and the `ni` parameter of all upper-level jobnets of the job are not specified, the priority of the job is assumed to be the value specified for the `DEFAULTPRIORITY` environment setting parameter (If no value is specified for the `DEFAULTPRIORITY` environment setting parameter, then the priority is assumed to be 1). For details about the `DEFAULTPRIORITY` environment setting parameter, see 20.4.2(108) `DEFAULTPRIORITY` in the *JPI/Automatic Job Management System 3 Configuration Guide*.

`ex="execution-agent-name";`

Define the name of the execution agent or execution agent group that is used to execute jobs.

You can set a character string of 1 to 255 bytes.

If you want to use a double quotation mark (") or a hash mark (#) as a character, prefix the character by #. That is, use #" instead of " and use ## instead of #.

You can specify a macro variable for the execution agent name. Set *macro-variable-name* as a character string of no more than 64 bytes, using the format ?AJS2xxxx?. In the xxxxx part, you can use uppercase alphabetic characters (A to Z), numerals (0 to 9), and periods (.).

`un="target-user-name";`

Define the name of the OS user responsible for executing a job in the agent host.

You can set a character string of 1 to 63 bytes. You cannot specify a space character in the user name.

If you want to use a double quotation mark (") or a hash mark (#) as a character, prefix the character by #. That is, use #" instead of " and use ## instead of #.

You can specify a macro variable for the target user name. Set *macro-variable-name* as a character string of no more than 64 bytes, using the format ?AJS2xxxx?. In the xxxxx part, you can use uppercase alphabetic characters (A to Z), numerals (0 to 9), and periods (.).

`jd={nm|ab|cod|mdf|exf};`

Define the type of end judgment. The default is `cod`.

If you specify a value other than `cod`, you cannot specify the `rjs`, `rje`, `rec`, and `rei` parameters. In addition, you cannot specify `y` for the `abr` parameter. If you specify `y`, unit creation fails.

- `nm`: Always assumes a normal end.
- `ab`: Always assumes an abnormal end.
- `cod`: Normal end if the return code is below a set value
- `mdf`: Normal end if the file is refreshed during the period between the start and the end of job execution

- `exf`: Normal end if a file is created at the end of job execution

`wth=n;`

Define the warning threshold.

You can set 0 to 2,147,483,647.

`tho=n;`

Define the abnormal threshold.

You can set 0 to 2,147,483,647. The default is 0.

`jdF="end-judgment-file-name";`

Define an end judgment file name on the agent host for job execution.

You can set a character string of 1 to 511 bytes. We recommend that you specify the file name by using the absolute path. Assume that you specify the file name by using the relative path when the HTTP connection job is executed by Windows. In such a case, the path will be the relative path from the work directory used when the agent process (set in the environment settings of the agent) is executed. If the HTTP connection job is executed by Linux, the path will be the relative path from the home directory for the execution user. If the home directory has not been defined, the path will be the relative path from the root directory (/).

If you want to use a double quotation mark (") or a hash mark (#) as a character, prefix the character by #. That is, use # " instead of " and use ## instead of #.

The end judgment file name can contain macro variables. Set *macro-variable-name* as a character string of no more than 64 bytes, using the format ?AJS2xxxx?. In the *xxxxx* part, you can use uppercase alphabetic characters (A to Z), numerals (0 to 9), and periods (.).

`abr={y|n};`

Define whether retrying on an abnormal end is enabled. If you omit this option, the system assumes `n`.

You can specify `y` only when you specify `cod` for the `jd` parameter.

- `y`: Automatic retries are performed if an abnormal end occurs.
- `n`: Automatic retries are not performed if an abnormal end occurs.

`rjs= lower-limit-of-return-codes-to-be-retried-automatically;`

Define the lower limit of the return codes to be retried automatically if an abnormal end occurs.

This option can be specified only if automatic retrying is performed when an abnormal end occurs (`y` is specified for the `abr` parameter).

You can specify a value from 1 to 4,294,967,295. If you specify a value equal to or smaller than the abnormal threshold (the `tho` parameter) and a value greater than the upper limit on return codes to be automatically retried (the `rie` parameter), unit creation fails.

If this option is omitted, a lower limit for the return codes to be retried automatically is not defined, and *abnormal-threshold* + 1 is assumed when the job is executed.

`rje=upper-limit-of-return-codes-to-be-retried-automatically;`

Define the upper limit of the return codes to be retried automatically if an abnormal end occurs.

This option can be specified only if automatic retrying is performed when an abnormal end occurs (`y` is specified for the `abr` parameter).

You can specify a value from 1 to 4,294,967,295. If you specify a value equal to or smaller than the abnormal threshold (the `tho` parameter) and a value smaller than the lower limit of the return codes to be retried automatically (the `ris` parameter), unit creation fails.

If this option is omitted, an upper limit of the return codes to be automatically retried is not defined, and the maximum value (4,294,967,295) is assumed when the job is executed.

`rec=maximum-number-of-retry-executions;`

Define the maximum number of retry executions only when automatic retry is performed for an abnormal end (`y` is specified for the `abr` parameter).

You can specify a value from 1 to 12 (times). If you omit this option, the system assumes 1.

`rei=retry-interval;`

Define the retry interval only when automatic retrying is performed for an abnormal end (`y` is specified for the `abr` parameter).

You can specify a value from 1 to 10 (minutes). If you omit this option, the system assumes 1.

`ha={y|n};`

Define whether to suspend job execution. The default is `n`.

- `y`: Suspends job execution.
- `n`: Does not suspend job execution.

`eu={ent|def};`

Define the JP1 user who executes the job. The default is `ent`.

- `ent`: The JP1 user who registered the jobnet executes the job.
- `def`: The JP1 user who owns the job executes the job.

`mm={and|or};`

Define the wait method with respect to the specified units whose ends are being waited for. The default is `and`.

- `and`: Start executing at completion of all units whose ends are being waited for.
- `or`: Start executing at completion of one of the units whose ends are being waited for.

`nmg={y|n};`

Define the behavior when there are no generations of the root jobnet for the specified unit whose end is being waited for.

The default is `n`.

- `y`: Start executing.
- `n`: Do not start executing.

`eun=name-of-the-unit-whose-end-is-being-waited-for;`

Define the full-path name of a unit whose end is being waited for.

To specify multiple units, repeat the parameter. You can specify a maximum of 32 units.

You can use a character string of 1 to 930 bytes as the unit name.

`ega={exec|execdefer|none};`

Specify the behavior when a jobnet with start conditions is specified as the jobnet whose end is being waited for and the execution generation ends abnormally.

If you omit this option, the system assumes `none`.

- `exec`: Start executing.
- `execdefer`: Do not start executing. However, if the execution generation is in the *Skipped so not exe.* status, start executing.
- `none`: Do not start executing.

```
uem={y|n};
```

Specify the behavior when a jobnet with start conditions is specified as the jobnet whose end is being waited for and the monitoring generation is in the *Unmonitored + Ended* status.

If you omit this option, the system assumes n.

- y: Start executing.
- n: Do not start executing.

5.2.28 Custom event job definition

This paragraph explains how to specify a definition for a custom event job.

The following gives the format and parameters for a custom event job definition.

Format

```
cety="identifier";
[jpoif=macro-variable-name:passing-information-name;]
[etm=n;]
[fd=time-required-for-execution;]
[ex="execution-agent-name";]
[ha={y|n};]
[eu={ent|def};]
[ets={kl|nr|wr|an};]
[mm={and|or};]
[nmg={y|n};]
[eun=name-of-the-unit-whose-end-is-being-waited-for;]
[ega={exec|execdeffer|none};]
[uem={y|n};]
[cprrm="parameter-name=value";]
```

Parameters

```
cety="identifier";
```

Defines the information that identifies the program to be linked with a custom event job. Specify a character string that begins with CE and is not longer than 16 bytes.

The value that can be defined differs depending on the program to be linked. For details, see the applicable documentation for the program to be linked.

If you specify a value that is not provided by the linked program, the job ends abnormally.

```
jpoif=macro-variable-name:passing-information-name;
```

Set *macro-variable-name* as a character string of no more than 64 bytes, using the format ?AJS2xxxx?. In the *xxxxx* part, you can use uppercase alphabetic characters (A to Z), numerals (0 to 9), and periods (.).

This parameter can contain up to 2,048 bytes in the "*jpoif=macro-variable-name:passing-information-name;*".

This parameter makes it possible to take over event information of subsequent Unix jobs, PC jobs, flexible jobs, HTTP connection jobs, and action jobs.

The values that can be specified as the passing information names are CMTMOUT and OBJECT01 to OBJECT10.

```
etm=n;
```

Define the time-out period using the relative minutes from the start time. You can set 1 to 1,440 minutes. This parameter is invalid for a job within the start condition.

`fd=time-required-for-execution;`

Define the time-required-for-execution within which the job is expected to be terminated.

You can specify a decimal value between 1 and 1,440 (minutes).

If you define this parameter as a start condition, it is disabled when a job is executed.

`ex="execution-agent-name";`

Define the name of the execution agent that is used to execute jobs.

You can set a character string of 1 to 255 bytes.

If you want to use a double quotation mark (") or a hash mark (#) as a character, prefix the character with #. That is, use #" instead of ", and use ## instead of #.

You can specify a macro variable.

`ha={y|n};`

Define whether to suspend job execution. The default is n. This parameter is invalid for a job within the start condition.

- y: Suspends job execution.
- n: Does not suspend job execution.

`eu={ent|def};`

Define the JP1 user who executes the job. The default is ent.

- ent: The JP1 user who registered the jobnet executes the job.
- def: The JP1 user who owns the job executes the job.

`ets={k1|nr|wr|an};`

Define the state of the custom event job after the execution time-out period elapses. The default is k1. This parameter is invalid for a job within the start condition.

- k1: Killed
- nr: Ended normally
- wr: Ended with warning
- an: Ended abnormally

`mm={and|or};`

Define the wait method with respect to the specified units whose ends are being waited for. The default is and.

- and: Start executing at completion of all units whose ends are being waited for.
- or: Start executing at completion of one of the units whose ends are being waited for.

`nmg={y|n};`

Define the behavior when there are no generations of the root jobnet for the specified unit whose end is being waited for.

The default is n.

- y: Start executing.
- n: Do not start executing.

`eun=name-of-the-unit-whose-end-is-being-waited-for;`

Define the full-path name of a unit whose end is being waited for.

To specify multiple units, repeat the parameter. You can specify a maximum of 32 units.

You can use a character string of 1 to 930 bytes as the unit name.

```
ega={exec|execdeffer|none};
```

Specify the behavior when a jobnet with start conditions is specified as the jobnet whose end is being waited for and the execution generation ends abnormally.

If you omit this option, the system assumes *none*.

- *exec*: Start executing.
- *execdeffer*: Do not start executing. However, if the execution generation is in the *Skipped so not exe.* status, start executing.
- *none*: Do not start executing.

```
uem={y|n};
```

Specify the behavior when a jobnet with start conditions is specified as the jobnet whose end is being waited for and the monitoring generation is in the *Unmonitored + Ended* status.

If you omit this option, the system assumes *n*.

- *y*: Start executing.
- *n*: Do not start executing.

```
cprm="parameter-name=value";
```

Specifies a unit definition parameter for a custom event job in the *parameter-name=value* format.

You can set a character string of 2 to 20,479 bytes. If you specify multiple *cprm* options at the same time, the total number of characters in all specified values must not exceed 20,479 minus the number of specified *cprm* options plus 1 (unit: bytes). For example, if you specify five *cprm* options at the same time for one unit, the total number of characters that can be specified for the five values is a maximum of 20,475 (= 20479 - 5 + 1) bytes.

To specify a value that includes a double quotation mark (") or hash mark (#), prefix the cast character (#) to cast the mark. For a double quotation mark ("), specify #", and for a hash mark (#), specify ##.

For the *value* portion, you can also specify a macro variable. In that case, you can set a character string of 9 to 20,479 bytes using the *"parameter-name=macro-variable-name"* format. Set *macro-variable-name* as a character string of no more than 64 bytes, using the format ?AJS2xxxxx?. In the *xxxxx* part, you can use uppercase alphabetic characters (A to Z), numerals (0 to 9), and periods (.).

5.2.29 Start condition definition

This paragraph explains how to specify a start condition definition.

To define start conditions, specify the unit definition parameter for the root jobnet, and then the unit attribute parameter for start conditions. For the start condition unit, attach the string *.CONDITION*. For the start condition unit, you can define up to 32 event jobs and custom event jobs. Note, however, that you cannot define a recovery job for an event job and a custom event job.

The following gives the format of, and the parameters for a start condition definition.

Format

```
[cond={and|or};]  
[mcs={m|w|s};]  
[cgs={y|n};]  
[ab={exec|hold|stop};]
```

Parameters

`cond={and|or};`

Define the connection type of start conditions. The default is `and`.

- `and`: ANDs start conditions.
- `or`: ORs start conditions.

`mcs={m|w|s};`

Specify how the system behaves if there is already a monitoring generation whose status is *Now monitoring* when the monitoring of start conditions is started. If you omit this option, the system assumes `m`.

- `m`: The system starts the monitoring of start conditions. As a result, multiple monitoring generations are started. In this case, occurrence of one event causes start conditions of multiple generations to be satisfied.
- `w`: The system does not start the monitoring of start conditions, and waits for the monitoring generation in *Now running* status to terminate. In this situation, if a timeout for the jobnet occurs, the status changes to *Skipped so not exe*.
- `s`: The system skips starting the monitoring of start conditions. The status of the skipped monitoring generation becomes *Skipped so not exe*.

`cgs={y|n};`

Specify whether to stay execution of a generation of a jobnet if the generation's start conditions are satisfied while another generation is already in *Now running* status when concurrent execution of jobnet generations is disabled. If you omit this option, the system assumes `y`.

- `y`: Execution of the jobnet is not repeated so that the generation stays.
If there is already a generation in *Now running* status when the start conditions of the next generation are satisfied, the system stays execution of the next generation until the generation in *Now running* status terminates. The status of the next generation is *Wait for start cond.* until the generation is executed.
- `n`: Execution of the jobnet is repeated so that the generation does not stay.
If there is already a generation in *Now running* status when the start conditions of the next generation are satisfied, the system does not stay execution of the next generation. The status of the next generation becomes *Skipped so not exe*.

`ab={exec|hold|stop};`

For a jobnet with start conditions, this parameter specifies the behavior of the jobnet's execution generations whose start conditions are satisfied, if the preceding execution generation has terminated abnormally. The default is `exec`.

- `exec`: Executes the jobnet generations whose start conditions are satisfied.
- `hold`: Holds the execution of the jobnet generations whose start conditions are satisfied.
- `stop`: Stops the jobnet that is monitoring whether the start conditions are satisfied (the monitoring generation of the jobnet).

5.2.30 Specifying the definition of a jobnet connector

This subsection describes how to specify the definition of a jobnet connector.

The definition format and parameters that can be specified are as follows.

Format

```
[ncr=connection-destination-root-jobnet-name;]  
[ncex={y|n};]  
[nchn="connection-host-name";]  
[ncsv=connection-service-name;]  
[mm={and|or};]  
[nmg={y|n};]  
[eun=name-of-the-unit-whose-end-is-being-waited-for;]  
[ega={exec|execdeffer|none};]  
[uem={y|n};]
```

Parameters

ncr=connection-destination-root-jobnet-name;

Specify the unit full name of the root jobnet for which you want to control the execution order by using this jobnet connector. If the root jobnet is immediately under a planning group, specify the unit full name of the planning group. You can specify a character string of 1 to 930 bytes.

ncex={y|n};

If the execution order of a root jobnet is to be controlled, define whether to enable linkage between scheduler services. If you omit this option, the system assumes n.

- *y*: Linkage between scheduler services is enabled.
Linkage with jobnet connectors defined on other hosts or in other scheduler services is possible.
- *n*: Linkage between scheduler services is disabled.
Linkage with jobnet connectors defined in only the same scheduler service is possible.

nchn="connection-host-name";

Specify the name of the host on which the jobnet to be connected has been defined.

You can specify a character string of 1 to 255 bytes. You cannot specify spaces, tab characters, or linefeed characters.

If you specify this option when *y* has not been specified for the *ncex* parameter, an error occurs.

If you want to use a double quotation mark (") or a hash mark (#) as a character, prefix the character by #. That is, use #" instead of " and use ## instead of #.

ncsv=connection-service-name;

Specify the name of the scheduler service in which the jobnet to be connected has been defined. You can specify a character string of 1 to 30 bytes.

If you specify this option when *y* has not been specified for the *ncex* parameter, an error occurs.

mm={and|or};

Define the wait method with respect to the specified units whose ends are being waited for.

The default is *and*.

- *and*: Start executing at completion of all units whose ends are being waited for.
- *or*: Start executing at completion of one of the units whose ends are being waited for.

nmg={y|n};

Define the behavior when there are no generations of the root jobnet for the specified unit whose end is being waited for.

The default is *n*.

- *y*: Start executing.

- n: Do not start executing.

eun=*name-of-the-unit-whose-end-is-being-waited-for*;

Define the full-path name of a unit whose end is being waited for.

To specify multiple units, repeat the parameter. You can specify a maximum of 32 units.

You can use a character string of 1 to 930 bytes as the unit name.

ega={exec|execdefer|none};

Specify the behavior when a jobnet with start conditions is specified as the jobnet whose end is being waited for and the execution generation ends abnormally.

If you omit this option, the system assumes none.

- exec: Start executing.
- execdefer: Do not start executing. However, if the execution generation is in the *Skipped so not exe.* status, start executing.
- none: Do not start executing.

uem={y|n};

Specify the behavior when a jobnet with start conditions is specified as the jobnet whose end is being waited for and the monitoring generation is in the *Unmonitored + Ended* status.

If you omit this option, the system assumes n.

- y: Start executing.
- n: Do not start executing.

5.3 Examples of specifying unit definition parameters

This subsection gives the following six examples of specifying unit definition parameters.

- Example of defining a job group
- Example of defining a jobnet
- Example of defining a job
- Example of defining a related nested jobnet
- Example of defining start conditions for the root jobnet
- Example of defining a jobnet connector

5.3.1 Example of defining a job group

(1) Example of defining a job group

This example covers definition of a job group that meets the following conditions:

- One job group is defined.
- The job group name is `group`.
- The unit attributes are `owner: update, group: references, and others: references`.
- In the calendar, set Saturday and Sunday as closed days. The base time is 6:00.

The following gives an example of definition.

```
/* Create new job group "group" */
unit=group;
{
  ty=g;
  cl=sa;
  cl=su;
  stt=06:00;
}
```

(2) Example of defining a planning group

This example covers definition of a planning group which meets the following conditions:

- One planning group is defined.
- The planning group name is `pgroup`.

The following gives an example of definition.

```
/* Create new planning group "pgroup" */
unit=group;
{
  ty=g;
  gty=p;
}
```

5.3.2 Example of defining a jobnet

This example covers definition of a jobnet which meets the following conditions:

- One jobnet is defined.
- The jobnet name is net.
- The unit attributes are owner: update, group: operations and others: reference.
- The start time of jobnet execution is 13:00 on June 30, 20XX.
- The jobnet is executed every day.

The following gives an example of definition.

```
/* Create new jobnet "net" */
unit=net;
{
  ty=n;
  sd=1,20XX/6/30;
  st=1,13:00;
  cy=1,(1,d);
}
```

5.3.3 Example of defining a job

This example covers definition of a job which meets the following conditions:

- One job is defined.
- The job name is job.

The following gives an example of definition.

```
/* Create new job "job" */
unit=job;
{
  ty=j;
  te="sleep 10";
}
```

5.3.4 Example of defining a related nested jobnet

This example covers creation of a new jobnet that meets the following conditions:

- The following jobnet is defined.

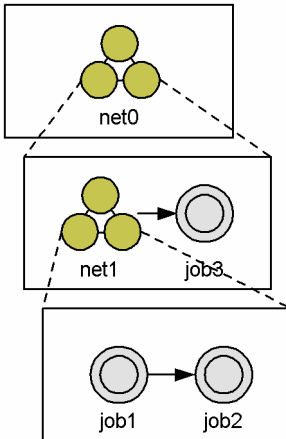

The following gives an example of definition.

```
/* Create new jobnet "net0" */
unit=net0;
{
  ty=n;
  ar=(f=net1,t=job3);

  /* Define jobnet "net1" */
  unit=net1;
  {
    ty=n;
    ar=(f=job1,t=job2);

    /* Define job "job1" */
    unit=job1;
    {
      ty=j;
    }

    /* Define job "job2" */
    unit=job2;
    {
      ty=j;
    }
  }

  /* Define job "job3" */
  unit=job3;
  {
    ty=j;
  }
}
```

5.3.5 Example of defining start conditions for the root jobnet

This example covers creation of a new jobnet that meets the following conditions:

- The following root jobnet topnet (with the start conditions) is defined.

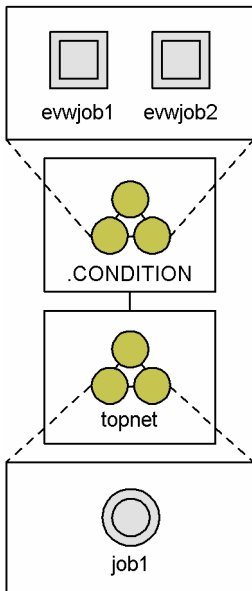

- For jobnet `.CONDITION` with the start conditions, set *reception of an event whose event ID is 111 or 222*.

The following gives an example of definition.

```

unit=topnet;
{
  /* Start to define the start conditions */
  ty=n;

  /* Define jobnet ".CONDITION" with the start conditions */
  unit=.CONDITION;
  {
    /* Start jobnet "topnet" if either of the two events */
    /* meets the conditions */
    ty=rc;
    cond=or;

    /* Define the first event job */
    unit=ewwjob1;
    {
      ty=ewwj;
      evid=111;
    }

    /* Define the second event job */
    unit=ewwjob2;
    {
      ty=ewwj;
      evid=222;
    }
  }
  /* Define jobnet "topnet" */
  unit=job1;
  {
    ty=j;
  }
}

```

5.3.6 Example of defining a jobnet connector

This subsection shows an example of defining jobnet connectors under the following conditions:

- Jobnet connectors for controlling the execution order of root jobnets `jobnetA`, `jobnetB`, and `jobnetC` are defined.
- Root jobnet `jobnetA` is first executed, then root jobnet `jobnetB` is executed, and finally root jobnet `jobnetC` is executed.
- The jobnet connectors are defined as `JC1`, `JC2`, and `JC3` in jobnet `jobnetS`.

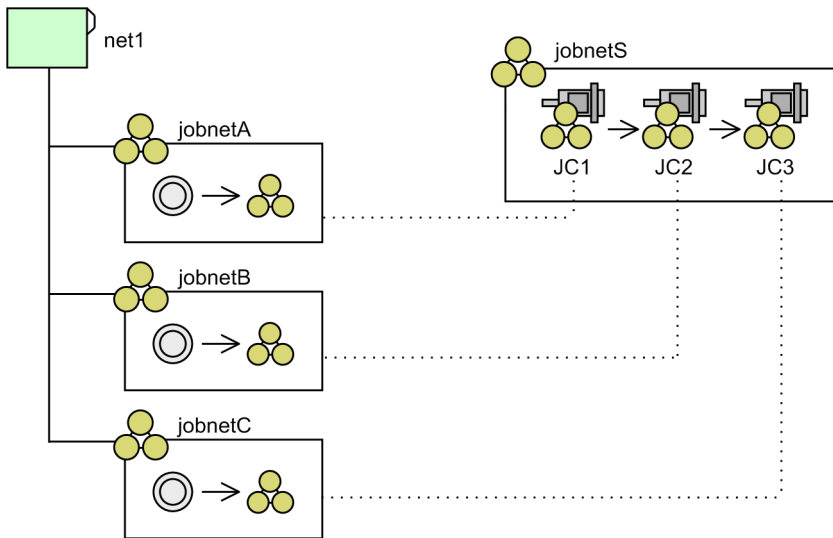

The following explains how you can define jobnet connectors under the above conditions.

First, create jobnet `jobnetS` in which jobnet connectors will be defined. Then, in `jobnetS`, define jobnet connectors `JC1`, `JC2`, and `JC3`, which control the execution order of root jobnets `jobnetA`, `jobnetB`, and `jobnetC`.

```

/* Create jobnet jobnetS */
unit=jobnetS,,jpladmin,;
{
  ty=n;
  el=JC1,nc,;
  el=JC2,nc,;
  el=JC3,nc,;
  ar=(f=JC1,t=JC2,seq);
  ar=(f=JC2,t=JC3,seq);

  /* Define jobnet connector JC1 */
  unit=JC1;
  {
    ty=nc;
    ncr=/net1/jobnetA;
  }

  /* Define jobnet connector JC2 */
  unit=JC2;
  {
    ty=nc;
    ncr=/net1/jobnetB;
  }

  /* Define jobnet connector JC3 */
  unit=JC3;
  {
    ty=nc;
    ncr=/net1/jobnetC;
  }
}

```

Next, for each of the root jobnets `jobnetA`, `jobnetB`, and `jobnetC`, define execution order control information (such as the name of the jobnet connector that controls the root jobnet).

```
/* Modify the definition of jobnet jobnetA */
unit=jobnetA,,jpladmin,;
{
  ty=n;
  ...
  ...
  ncl=y;
  ncn=/AJSROOT1/net1/jobnets/JC1;
  ncs=n;
}

/* Modify the definition of jobnet jobnetB */
unit=jobnetB,,jpladmin,;
{
  ty=n;
  ...
  ...
  ncl=y;
  ncn=/AJSROOT1/net1/jobnets/JC2;
  ncs=n;
}

/* Modify the definition of jobnet jobnetC */
unit=jobnetC,,jpladmin,;
{
  ty=n;
  ...
  ...
  ncl=y;
  ncn=/AJSROOT1/net1/jobnets/JC3;
  ncs=n;
}
```

5.4 Creating a schedule information file

In a schedule information file, define the schedules of jobnet and job execution. To use the `ajsentry` command to register fixed jobnet execution, specify the schedule information file and determine the fixed schedule.

This section explains how to create the schedule information file.

5.4.1 Format of the schedule information file

Figure 5-2 shows how to specify the schedule information parameters in the schedule information file.

Figure 5–2: Format of the schedule information file

```
/* comment */ ..... (A)
schedule-information-parameter-for-jobnet ..... (B)
{ ..... (C)
    schedule-information-parameter-group-for-job ..... (D)
    schedule-information-parameter-for-lower-level-jobnet
    {
        nest-definitions-of-lower-level-jobnet
        nest-definitions-of-lower-level-jobnet
        nest-definitions-of-lower-level-jobnet
    }
    schedule-information-parameter-for-lower-level-jobnet
    schedule-information-parameter-for-lower-level-jobnet
    schedule-information-parameter-for-lower-level-jobnet
} ..... (E)

multiple-generation-definitions-of-schedule-information-parameter
multiple-generation-definitions-of-schedule-information-parameter
multiple-generation-definitions-of-schedule-information-parameter
```

The following explains each item in the file.

(A) *comment*

To make a comment, enclose it within `/*` and `*/`.

You cannot write a comment in a line where you have defined a schedule information parameter for a jobnet or job.

(B) *schedule-information-parameter-for-jobnet*

Specify the schedule information parameters for a jobnet.

The following gives the format of this item.

```
EN=information-1 : [information-2] : [information-3] : [information-4] : [information-5] :
[information-6] [ : [information-7] : [information-8] [ : [information-9] ] ] ;
```

The following explains each parameter.

information-1

Specify a jobnet name. You can set a character string of 1 to 30 bytes. Note that if the character encoding is UTF-8 and `sjis` is specified for the `DEFLENTYPE` environment setting parameter, you can specify from 1 to 30 bytes after conversion to Shift-JIS.

information-2

Specify the start time of jobnet execution in the format of *YYYYMMDDHHMM*.

The following explains the contents of *YYYYMMDDHHMM*.

YYYY: Year of execution. The value you can set ranges from the calendar year of the date when jobnet execution is registered to the calendar year the value of the `SCHEDULELIMIT` environment setting parameter. For details about the `SCHEDULELIMIT` environment setting parameter, see *20.4.2(123) SCHEDULELIMIT* in the *JP1/Automatic Job Management System 3 Configuration Guide*.

MM: Month of execution. You can set 1 to 12 as the month value.

DD: Day of execution. You can set 1 to 31 as the day value.

HH: Hours of execution. You can set 0 to 47 as the hours value.

MM: Minutes of execution. You can set 0 to 59 as the minutes value.

The following are the defaults.

Root jobnet: Time of registration for execution

Nested jobnet: No execution schedule

information-3

Specify whether to suspend jobnet execution. The default is the hold attribute defined for the jobnet.

- `h`: Suspends jobnet execution.
- `n`: Does not suspend jobnet execution.

information-4

Define the time when the delayed jobnet start is monitored. By default, the delayed start is not monitored.

- Specify the absolute time in the format of *HHMM*.

HH: Hours of the time when to monitor the delayed start. You can set 0 to 47 as the hours value.

MM: Minutes of the time when to monitor the delayed start. You can set 0 to 59 as the minutes value.

- Specify the relative minutes in the format of *RMMMM*.

R: Specify the type of the relative value for determining when to start delay monitoring. 'M' refers to the relative minutes from the time when to start root jobnet execution, 'U' to the relative minutes from the time when to start upper-level jobnet execution, and 'C' to the relative minutes from the time when to start jobnet execution.

MMMM: Specify the period until the start of delay monitoring as the relative minutes from the jobnet start time. You can set 1 to 2,879 minutes.

information-5

Specify the time when the delayed jobnet end is monitored. By default, the delayed end is not monitored.

- Specify the absolute time in the format of *HHMM*.

HH: Hours of the time when to monitor the delayed start. You can set 0 to 47 as the hours value.

MM: Minutes of the time when to monitor the delayed start. You can set 0 to 59 as the minutes value.

- Specify the relative minutes in the format of *RMMMM*.

R: Specify the type of the relative value for determining when to start delay monitoring. 'M' refers to the relative minutes from the time when to start root jobnet execution, 'U' to the relative minutes from the time when to start upper-level jobnet execution, and 'C' to the relative minutes from the time when to start jobnet execution.

MMMM: Specify the period until the start of delay monitoring as the relative minutes from the jobnet start time. You can set 1 to 2,879 minutes.

information-6

Specify the priority of execution. You can set *n*, or 1 to 5. If you set *n*, the system inherits the priority of execution defined for the upper-level jobnet. The lowest priority is 1, while the highest priority is 5.

The system defaults to the priority of schedule execution defined for the jobnet.

information-7

Define the time for the jobnet to wait for an event. By default, the time to wait for an event is not set.

- *n*: Does not set the time to wait for an event.
- Specify the absolute time in the format of *HHMM*.
HH: Hours of the time when to start waiting for an event. You can set 0 to 47 as the hours value.
MM: Minutes of the time when to start waiting for an event. You can set 0 to 59 as the minutes value.
- Specify the relative minutes in the format of *RMMMM*.
R: Refers to the relative minutes from the time when to start jobnet execution.
MMMM: Specify the period until the start of waiting for an event by the relative minutes from the time when to start jobnet execution. You can set 1 to 2,879 minutes.
- *U*: Waits without any limit.

information-8

Specify the number of times the jobnet waits for an event. By default, a wait for an event is not set.

- *n*: Does not set a wait for an event.
- *N*: Specify the number of times the jobnet waits for an event. You can set 1 to 999.
- *U*: Wait without any limit for an event.

information-9

Specify the schedule rule number for the jobnet. You can specify a value from 1 to 144.

If you have suspended jobnets registered for fixed execution and added other jobnets, you can specify this information to calculate the schedule for such additional jobnets by using the schedule for upper-level jobnets. (For example, if you suspend jobnet A registered for fixed execution and add jobnet B, you can calculate the schedule for jobnet B from the schedule for jobnet A.)

If this information is omitted or if there is no match with the schedule rule number for upper-level jobnets, the system does not set the schedule for the jobnet being added during the suspend process.

(C) {

Indicates the start of a schedule information parameter.

The contents between { and corresponding } provide one schedule information parameter. One schedule information parameter provides one jobnet execution schedule.

(D) *schedule-information-parameter-group-for-job*

Specify schedule information parameters for a job.

Specify the parameters immediately after the schedule information parameter for the jobnet containing the job. The following gives the format of a schedule information parameter for a job.

| |
|--|
| $PJ=information-1 : [information-2] : [information-3] ;$ |
|--|

The following explains each parameter.

information-1

Specify a job name. You can set a character string of 1 to 30 bytes. Note that if the character encoding is UTF-8 and `sjis` is specified for the `DEFLENTYPE` environment setting parameter, you can specify from 1 to 30 bytes after conversion to Shift-JIS.

information-2

Specify whether to execute the job. The default is `y`.

- `y`: Executes the job.
- `n`: Does not execute the job.

information-3

Specify whether to suspend job execution. Default is the hold attribute defined for the job.

- `h`: Suspends job execution.
- `n`: Does not suspend jobnet execution.

(E) }

Indicates the end of a schedule information parameter.

5.4.2 Notes on defining a schedule information parameter

The following are notes on defining a schedule information parameter.

- You cannot use a schedule information parameter to define a schedule for a unit not defined by using the `ajsdefine` command.
- If multiple schedule information parameters are defined for one jobnet execution schedule, only the last defined schedule information parameter is valid.
- For a nested jobnet, define schedules for all the units contained in the nested jobnet using the schedule information parameter. Otherwise, the system does not execute the nested jobnet.
- When you omit the schedule information parameter for a job, the job is executed in the same schedule for the jobnet if it is executed.
- If the execution schedule time of the lower-level jobnet is more than 24 hours after the base time of upper-level jobnet execution, the system rounds this time within 24 hours. The following gives an example of the rounding.

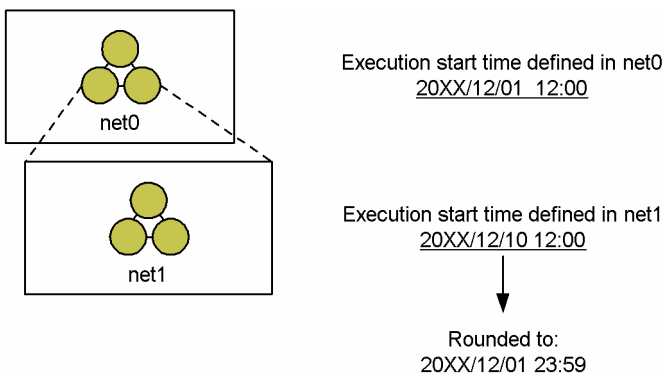

For the jobnet having the above configuration, the execution start time of jobnet `net1` is rounded to 23:59 December 1, 20XX.

5.5 Example of a schedule information parameter

This subsection gives an example of a schedule information parameter to define a schedule for a jobnet which meets the conditions below.

The following shows the configuration of the units.

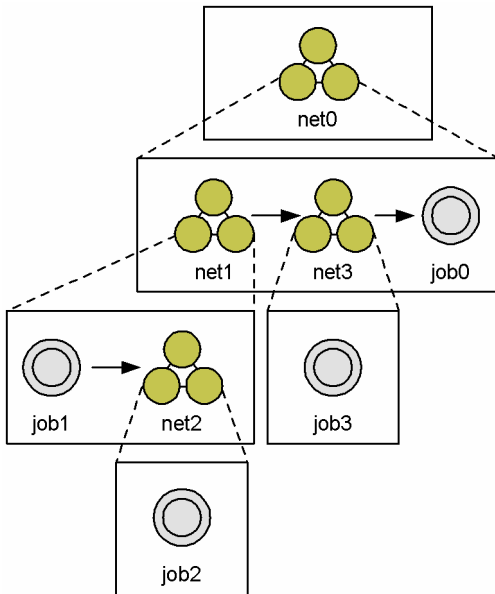

The following table covers schedules to be defined.

| Unit | Execution start time | Hold attribute for execution |
|------|----------------------|------------------------------|
| net0 | 20XX/12/1 12:00 | Hold |
| net1 | 20XX/12/1 12:00 | Not hold |
| job1 | Execute | Not hold |
| net2 | 20XX/12/1 14:00 | Not hold |
| job2 | Execute | Not hold |
| net3 | 20XX/12/1 13:00 | Hold |
| job3 | Not execute | N/A |
| job0 | Execute | Not hold |

Legend:

N/A: Not applicable

The following gives an example of description.

```
/* Start to define schedule information on jobnet "net0" */
PN=net0:20XX12011200:h:;;;
{
  /* Start to define schedule information on jobnet "net1" */
  PN=net1:20XX12011200:n:;;;
  {
    PJ=job1:y:n;

    /* Start to define schedule information on jobnet "net2" */
    PN=net2:20XX12011400:n:;;;
    {
      PJ=job2:y:n;
    }
  }

  /* Start to define schedule information on jobnet "net3" */
  PN=net3:20XX12011300:h:;;;
  {
    PJ=job3:n;;
  }

  /* Start to define schedule information on job "job0" */
  PJ=job0:y:n;
}
```

5.6 File of registered execution-schedule information for jobnets

A file of registered execution-schedule information for jobnets to which jobnet execution registration information is exported by executing the `ajsrsexport` command.

The information that has been exported to this file can be imported to the manager by executing the `ajsrimport` command.

Cautionary note

We do not recommend that you modify a file of registered execution-schedule information for jobnets that has been exported. If a modified file is imported, the system might be unable to operate correctly.

5.6.1 Format of a file of registered execution-schedule information for jobnets

The following figure shows the format of parameters defined in a file of registered execution-schedule information for jobnets.

Figure 5–3: Format of parameters defined in a file of registered execution-schedule information for jobnets

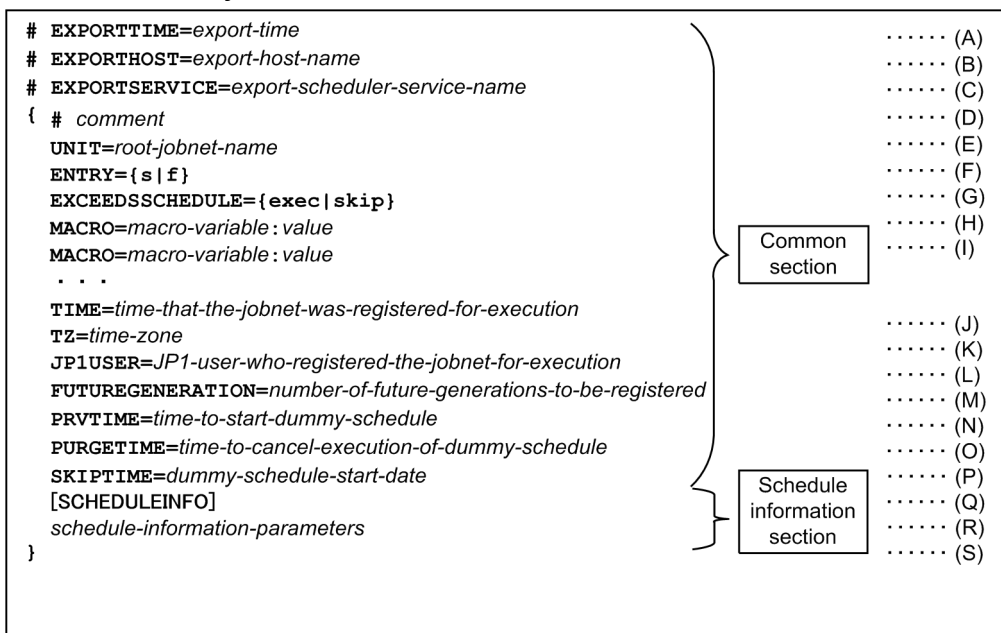

The following describes the items specified in the file.

(A) *export-time*

The time that the registered execution-schedule information was exported is output.

Output format:

Japanese: *YYYY/MM/DD hh:mm:ss*

English: *MMM DD YYYY hh:mm:ss*

(B) *export-host-name*

The name of the host on which the registered execution-schedule information was exported is output.

Output format:

FQDN format (In a non-DNS environment, a short name is output.)

(C) *export-scheduler-service-name*

The name of the scheduler service from which the registered execution-schedule information was exported is output. If the scheduler service name was not specified when the `ajsrsexport` command was executed, the default scheduler service name is output.

(D) Start of parameter specifications

A left curly bracket (`{`) is used to indicate the start of a group of registered execution-schedule information parameters. This item cannot be omitted. The end of the group is indicated by a right curly bracket (`}`). A left curly bracket (`{`) and a right curly bracket (`}`) must be specified in pairs. A group of registered execution-schedule information parameters is specified for each jobnet.

(E) *comment*

A line that begins with a hash mark (`#`) is treated as a comment line.

A comment cannot be specified on a line on which a parameter has been defined.

A comment line can be added anywhere in the file.

(F) *UNIT=root-jobnet-name*

Specifies the unit full name of the root jobnet to be registered for execution. You can specify a character string of 1 to 930 bytes.

This parameter cannot be omitted. Multiple `UNIT` parameters cannot be specified.

The unit full name cannot be followed by a host name, scheduler service name, or execution ID.

(G) *ENTRY={s|f}*

Specifies the type of execution registration. Either of the following types can be specified:

`s`: The jobnet is registered for planned execution.

`f`: The jobnet is registered for fixed execution.

This parameter cannot be omitted. Multiple `ENTRY` parameters cannot be specified.

(H) *EXCEEDSSCHEDULE={exec|skip}*

Specifies whether the jobnet is executed if the scheduled time for execution has already passed when the scheduler service is started.

`exec`

The jobnet is executed even if the scheduled time for execution has already passed when the scheduler service is started.

`skip`

The jobnet is not executed if the scheduled time for execution has already passed when the scheduler service is started.

If this parameter is omitted, the command assumes that `EXCEEDSSCHEDULE=exec` is specified.

Multiple `EXCEEDSSCHEDULE` parameters cannot be specified.

(I) *MACRO=macro-variable-name:value*

Specifies a macro variable name and the value to be passed via the macro variable during execution of the jobnet. One `MACRO=` specification can be followed by only one pair of macro variable name and value.

A maximum of 32 `MACRO` parameters can be specified.

Specification of `MACRO` parameters is required only when macro variables are used. Each `MACRO` parameter must be specified on a separate line. If multiple `MACRO` parameters are specified, the total number of characters that can be specified is 4,085 bytes.

Note that, after the file is imported and the job is executed, the macro variables specified here are inherited each time the next generation is created. Therefore, the specification of `MACRO` parameters is valid only in the following two cases: (1) when the execution registration type is registration for planned execution (`ENTRY=s`) and (2) when the number of future generations is specified in registration for fixed execution (when both `ENTRY=f` and `FUTUREGENERATION=x` (x : 1 to 99) are specified). If the execution registration type is other than the above, the specification of `MACRO` parameters is ignored. Specifically, the specification of `MACRO` parameters is ignored if the execution registration type is period-specified registration for fixed execution (that is, when `ENTRY=f` and `FUTUREGENERATION=0` are specified or when `ENTRY=f` is specified and `FUTUREGENERATION=x` is not specified). If the execution registration type is period-specified registration for fixed execution, the parameters must be specified in the (R) section.

macro-variable-name

The character string specified as a macro variable name can consist of upper-case letters, numeric characters, and periods (.).

The maximum length of the character string specified as a macro variable name is 62 bytes, excluding the question mark (?) at the beginning and the question mark (?) at the end of the string.

value

Any character string can be specified.

You can specify a character string of 1 to 255 bytes.

example 1

In the following example, only one macro variable is specified.

```
MACRO=AJS2ENV:/data/job_report
```

example 2

In the following example, multiple macro variables are specified.

```
MACRO=AJS2ENV:/data/job_report
MACRO=AJS2COM:c:\temp\test.exe
```

(J) `TIME=time-that the-jobnet-was-registered-for-execution`

The time that the jobnet was registered for execution is specified in the `YYYY/MM/DDΔhh:mm` format (Δ : space). You can specify a character string of 16 bytes. If this parameter is omitted, the time that the `ajsgimport` command was executed is assumed. The valid range of a value that can be specified is from 1994/01/01 00:00 to 2099/12/31 23:59. If **Registered day** is specified in the jobnet schedule rule, the schedule is calculated by using this time as the base point.

(K) `TZ=time-zone`

Specifies the time zone. You can specify a character string of 99 bytes. If this parameter is omitted, the system behaves in the same way as when the time zone is not specified.

(L) `JP1USER=JP1-user-who-registered-the-jobnet-for-execution`

Specifies the JP1 user who registered the jobnet for execution. You can specify a character string of 31 bytes. If this parameter is omitted, the JP1 user who executed the `ajsgimport` command is assumed.

(M) `FUTUREGENERATION=number-of-future-generations-to-be-registered`

Specifies the number of generations scheduled to be executed at the next and the following times. You can specify a value from 1 to 99. If the execution registration type is registration for planned execution (`ENTRY=s`), the specification of this parameter is ignored.

(N) `PRVTIME=time-to-start-dummy-schedule`

This parameter is used for schedule calculation, and must not be changed.

(O) `PURGETIME=time-to-cancel-execution-of-dummy-schedule`

This parameter is used for schedule calculation, and must not be changed.

(P) `SKIPTIME=dummy-schedule-start-time`

This parameter is used for schedule calculation, and must not be changed.

Note that when the file is imported, the generation management process automatically sets the value for this parameter. Therefore, after importing file of registered execution-schedule information for jobnets, even if you export that same information file without changing any settings, the `SKIPTIME` parameter values in the import and export files might be different. However, this difference causes no special problem.

(Q) Schedule information section

Schedule information is specified below the `[SCHEDULEINFO]` line. This section is required if schedule information parameters need to be specified. Note that if the execution registration type is registration for planned execution (`ENTRY=s`), the specification in this section is ignored.

(R) *schedule-information-parameters*

Parameters that determine the schedule information to be applied to registration for fixed execution are specified. If the execution registration type is registration for planned execution (`ENTRY=s`), these parameters are ignored. If the format of any schedule information parameter specified here conflicts with the configuration of the jobnet to be registered for execution, the KAVS4826-E message is output.

Schedule information parameters are specified in the following format.

```
PN=information-1 : [information-2] : [information-3] : [information-4] : [information-5] :  
[information-6] [ : [information-7] : [information-8] : [information-9] [ : [information-10] :  
[information-11] : [information-12] : [information-13] : [information-14] : [information-15] :  
[information-16] : [information-17] ] ;
```

The following explains the items in the section.

information-1 to information-9

For details about the *information-1 to information-9*, see *(B)schedule-information-parameter-for-jobnet* in [5.4.1 Format of the schedule information file](#).

information-10

Specifies the jobnet execution order control method.

y: The jobnet is executed synchronously.

n: The jobnet is executed asynchronously.

This item can be specified for only a root jobnet. If this item is omitted, the system behaves according to the root jobnet definition.

This item is ignored if it is specified for a nested jobnet.

information-11

Specifies the jobnet monitoring time (equivalent to the time-required-for-execution within which the job is expected to be terminated). You can specify a decimal value between 1 and 2,879 (minutes).

None: The jobnet is monitored according to the definition.

0: The jobnet is not monitored.

1 to 2879: The jobnet is monitored by using the specified value.

information-12

Specifies whether to execute the unit if the time to start the unit has already passed when the service is started.

exec: The unit is executed even if the time to start has already passed.

skip: The unit is not executed if the time to start has already passed.

This item can be specified for only a root jobnet. If you omit this option, the system assumes `exec`.

This item is ignored if it is specified for a nested jobnet.

information-13

Specifies the time that the jobnet was registered for execution. The time is specified in the *YYYYMMDDTTMM* format (in both Japanese and English). This item cannot be omitted.

This item can be specified for only a root jobnet.

This item is ignored if it is specified for a nested jobnet.

information-14

Specifies the time zone. The maximum length of the time zone that can be specified is 99 bytes.

This item can be specified for only a root jobnet. If this item is omitted, the system behaves in the same way as when the time zone is not specified.

This item is ignored if it is specified for a nested jobnet.

Note that the time zone must be enclosed in double quotation marks (").

information-15

Specifies the name of the JP1 user who registered the jobnet for execution (the name of the JP1 user who executed the `ajsentry` command).

This item can be specified for only a root jobnet. If this item is omitted, the user who executed the command is assumed.

This item is ignored if it is specified for a nested jobnet.

Note that the name of the JP1 user who registered the jobnet for execution must be enclosed in double quotation marks (").

information-16

Specifies macro variable information.

0: The macro variables specified in the common section are not used, and the macro variables specified in the schedule information section are used. If "" (null) is specified as a macro variable in the schedule information section, the macro variable is not used.

1: The macro variables specified in the common section are used.

This item can be specified for only a root jobnet. This item is ignored if it is specified for a nested jobnet.

information-17

Specifies a macro variable name and the value to be passed via the macro variable during execution of the jobnet.

This item can be specified for only a root jobnet. This item is ignored if it is specified for a nested jobnet.

Note that the macro variable must be enclosed in double quotation marks (").

For jobs, schedule information parameters are specified in the following format.

```
PJ=information-1 : [information-2] : [information-3] ;
```

For details about the *information-1* to *information-3*, see *(D)schedule-information-parameter-group-for-job* in [5.4.1 Format of the schedule information file](#).

(S) End of parameter specifications

A right curly bracket (}) is used to indicate the end of a group of execution registration information parameters. This item cannot be omitted.

If an export file containing the registered execution-schedule information about a root jobnet that has been registered for planned execution is imported, the schedule is created based on items (A) to (P) in the common section.

When registered execution-schedule information about a root jobnet that has been registered for fixed execution is exported, if schedule information that has already been generated exists, the information is output to the schedule information section. Therefore, if the exported file is then imported, schedule information is generated based on the

parameters in the schedule information section. Also, be careful if the `FUTUREGENERATION` value in (M) is at least 1 and the number of schedules generated in the schedule information section when the file is imported is less than the specified number of generations. In this case, the rest of the schedules are generated based on items (A) to (P) in the common section.

6

Overview of APIs

This chapter describes the APIs used to operate JP1/AJS3.

6.1 Workflow for using an API

You can use APIs released for JP1/AJS3 to execute or monitor a JP1/AJS3 - Manager unit from a user application. The following describes the workflow for using an API.

You can create a user application by using a programming language that can perform HTTP communication. To have a user application issue a request, specify the authentication information of the JP1 user. After a request is issued, the request is passed through the Web Console server and JP1/AJS3 - Manager, and then user authentication is performed by JP1/Base. If authentication is successful, processing is executed on JP1/AJS3 - Manager, and the response is returned to the user application. This authentication is performed every time a request is issued. The following figure shows the workflow of this processing.

Figure 6–1: Workflow for using an API

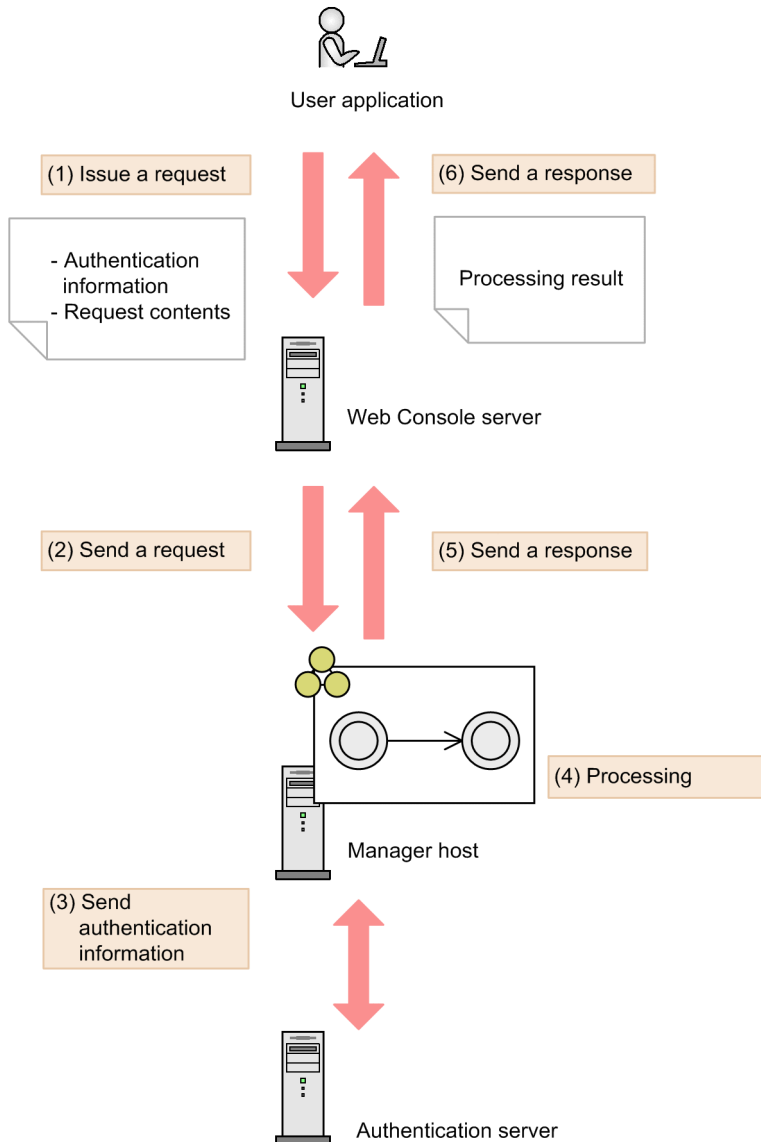

For details about what can be performed by using APIs, see *9.3 Operating JP1/AJS3 by using user applications* in the manual *JP1/Automatic Job Management System 3 Overview*.

Supplementary note

- The communication protocol used by APIs is HTTP/1.1. For details about the communication protocol, see the following specifications:

For the HTTP protocol:

RFC2616

For the HTTPS protocol:

RFC2818

- JP1/AJS3 also allows you to restrict the execution of APIs from a user application and restrict the JP1/AJS3 - Manager instances to which requests can be issued.

You can enable the functions for restricting the execution of APIs and for restricting connection-destination JP1/AJS3 - Manager instances by changing the settings in the environment settings file (`ajs3web.conf`) of the Web Console server. For details about the environment settings file (`ajs3web.conf`) in Windows, see *3.4.3 Details on the settings in the environment-settings file (ajs3web.conf) in the JP1/Automatic Job Management System 3 Configuration Guide*. For details about the environment settings file (`ajs3web.conf`) in Linux, see *13.3.3 Details on settings in the environment-settings file (ajs3web.conf) in the JP1/Automatic Job Management System 3 Configuration Guide*.

6.2 Authentication when using an API

To issue an API request and receive a response, authentication of the JP1 user is required every time a request is issued. The user authentication function of JP1/Base is used for the authentication method.

To receive authentication, specify `X-AJS-Authorization` for the request header when you issue a request, and send the JP1 user name and password. The authentication server (JP1/Base) on the manager host that received the request performs authentication of the specified JP1 user name and password. If you do not specify any JP1 user name or password, or if the specified JP1 user name or password is wrong, the status code 401 is returned, indicating that authentication is required. For details about the request header and the request format, see [6.4 Request format](#).

The following shows the format of the authentication information written in the request header.

```
X-AJS-Authorization: character-string-obtained-by-encoding-username:password  
-by-using-Base64-encoding
```

The following table lists and describes the parameters that can be specified for the request header `X-AJS-Authorization`.

Table 6–1: Parameters specified for X-AJS-Authorization

| Parameter name | Description | Required? |
|-----------------------|--|-----------|
| <code>userName</code> | Specify the JP1 user name by using a character string. The JP1 user to be specified here must have already been registered in the authentication server used by JP1/AJS3 - Manager on the login target. For details about the characters that can be used for the JP1 user name, see the descriptions about the user management settings in the <i>JP1/Base User's Guide</i> . | Y |
| <code>password</code> | Specify the password of the JP1 user by using a character string. For details about the characters that can be used for the password, see the descriptions about the user management settings in the <i>JP1/Base User's Guide</i> . | Y |

Legend:

Y: Required

Example

If the user name is `user` and the password is `password`, specify the following value (which is obtained by encoding `user:password` by Base64 encoding):

```
X-AJS-Authorization: dXNlcjpwYXNzd29yZA==
```

6.3 Data types usable for an API

The following table lists and describes the data types usable for an API.

Table 6–2: Data types usable for an API

| Data type | Description |
|---------------------|-----------------------|
| boolean | true or false |
| int | 32-bit signed integer |
| long | 64-bit signed integer |
| string [#] | Text data |

#

If you use a special character (such as a double quotation mark (") or backslash (\)) in JSON format, you need to escape such a character as shown in the following table.

Table 6–3: List of characters that need to be escaped

| Character | Escape notation |
|---|-----------------|
| Double quotation mark (") | \" |
| Backslash (\) | \\ |
| Backspace | \b |
| Form feed | \f |
| Line feed | \n |
| Carriage return | \r |
| Tab | \t |
| Unicode characters of 4-digit hexadecimal | \uXXXX |

The date and time are displayed in the following format when they are specified or returned in the ISO 8601 format:

Format

```
YYYY-MM-DDThh:mm:ssTZD
```

Table 6–4: Values that can be specified for the date and time

| Notation | Description | Specifiable value |
|----------|------------------|---|
| YYYY | Specify a year. | <ul style="list-style-type: none"> If the version of JP1/AJS3 - Web Console is 13-00 or later and the version of the connection-destination JP1/AJS3 - Manager is 13-00 or later: From 1994 to the four-digit year set for the SCHEDULELIMIT environment setting parameter of the connection-destination JP1/AJS3 - Manager[#] In cases other than the above: 1994 to 2036 |
| MM | Specify a month. | 01 to 12 |

| Notation | Description | Specifiable value |
|------------|---|--|
| <i>DD</i> | Specify a day. | From 01 to the last day of the specified month |
| <i>Hh</i> | Specify hours. | 00 to 23 |
| <i>Mm</i> | Specify minutes. | 00 to 59 |
| <i>Ss</i> | Specify seconds. | 00 to 59 |
| <i>TZD</i> | Specify the time difference between the time on the manager host and UTC. For UTC, specify Z. For any cases other than UTC, specify the value in the format of <i>+hh:mm</i> or <i>-hh:mm</i> . | Z, <i>+hh:mm</i> , <i>-hh:mm</i> |

#

For details about the `SCHEDULELIMIT` environment setting parameter of the connection-destination JP1/AJS3 - Manager, see [20.4.2\(123\) SCHEDULELIMIT](#) in the *JP1/Automatic Job Management System 3 Configuration Guide*.

You can check the version of JP1/AJS3 - Web Console from the return value (`productVersionNumber`) of the version information acquisition API function. You can check the version of the connection-destination JP1/AJS3 - Manager from the return value (`protocolVersionNumber`) of the JP1/AJS3 - Manager protocol version acquisition API function.

For details about the version information acquisition API, see [7.1.37 Version information acquisition API](#).

For details about the JP1/AJS3 - Manager protocol version acquisition API, see [7.1.38 JP1/AJS3 - Manager protocol version acquisition API](#).

For example, if the UTC is January 16, 2015, 00:00:00 a.m., and the manager host uses Japan Standard Time, the time difference with UTC is +9 hours, so the value is `2015-01-16T09:00:00+09:00`. If the manager host uses China Standard time, the time difference with UTC is +8 hours, so the value is `2015-01-16T08:00:00+08:00`.

If the manager host uses Eastern Standard Time, the time difference with UTC is -5 hours, so the value is `2015-01-15T19:00:00-05:00`.

For a country or region where summer time is introduced, specify the date and time, considering the summer time. For example, if the UTC is April 16, 2015, 00:00:00 a.m., and the manager host uses Eastern Standard Time (daylight saving time), the time difference with UTC is -4 hours, so the value is `2015-04-15T20:00:00-04:00`.

6.4 Request format

A request consists of the request line, request header, and message body. Specify a request in the following format:

```
methodΔ/application/component/apiVersion/domain/objectType/other?queryΔhttpVersion
requestHeader

messageBody
```

Legend:

Δ: space

Table 6–5: Entries and meanings of the request format

| Category | Entry | Setting |
|----------------|----------------------|--|
| Request line | <i>method</i> | Method |
| | <i>application</i> | Application identifier |
| | <i>component</i> | Component identifier |
| | <i>apiVersion</i> | API version |
| | <i>domain</i> | Domain |
| | <i>objectType</i> | Resource identifier |
| | <i>other</i> | Value for uniquely identifying a resource and an operation on the resource |
| | <i>query</i> | Query string |
| | <i>httpVersion</i> | Protocol version |
| Request Header | <i>requestHeader</i> | Request header |
| Message Body | <i>messageBody</i> | Message body |

Supplementary notes

- Specify the request line and request header by using ASCII characters.
- To specify a character that cannot be used for URI, URL encoding is required. Use UTF-8 for the character encoding.

6.4.1 Details of the values to be specified

The following describes details of the values that are to be specified as a request.

Method

Specify the method of the request. The following methods are supported by the APIs:

- GET
- POST

Application identifier

Specify the identifier of the application that provides the API. Specify the fixed value `ajs`.

Component identifier

Specify the identifier of the component. Specify the fixed value `api`.

API version

This version differs depending on the API. See the description for each API.

Domain

Specify the domain for which the API is operated. The following table lists and describes the domain and resources that can be managed by an API.

Table 6–6: Domain and resources that can be managed by an API

| Domain | Resource identifier | Description of the resource identifier |
|---------|---------------------|--|
| objects | statuses | Resource for status monitoring |
| | definitions | Resource for unit definition |

Resource identifier

Specify the identifier of the resource on which the API operates. For details about the resources that can be managed by an API, see [Table 6-6](#).

Value for uniquely identifying a resource and an operation on the resource

If necessary, specify the value that uniquely identifies the resource and the action type. For details, see the description for each API.

Query string

If necessary, specify the query string by adding a question mark (?) at the end of the URI, as follows:

```
parameter-name=value
```

If there are multiple parameters, specify as follows, by delimiting the parameters by an ampersand (&):

```
parameter-name=value&parameter-name=value
```

Protocol version

Specify the fixed value `HTTP/1.1`.

Request header

Specify the request header in the format of `request-header: value`. If you specify multiple request headers, delimit them by a line feed character. The following table lists and describes the request headers that can be specified.

Table 6–7: List of request headers

| Request Header | Description | Required? |
|---------------------|---|-----------|
| Host | Specify the host information in the following format: <i>host:port</i> For <i>host</i> , specify the host name or IP address of the Web Console server. For <i>port</i> , specify the port number. The default port number is 22252. | Y |
| X-AJS-Authorization | Specify the authentication information. For details, see 6.2 Authentication when using an API . | Y |
| Content-Type | Specify the data type of the request message body. Specify the fixed value <code>application/json</code> . | -- |

| Request Header | Description | Required? |
|-----------------|---|-----------|
| Accept-Language | <p>Specify the language code used for the message body of the response to be issued by JP1/AJS3 - Web Console.</p> <p>If Accept-Language is not specified, the default language code of the system is used.</p> <p>You can specify the following language codes:</p> <ul style="list-style-type: none"> • ja: Japanese • en: English • zh: Chinese <p>Note that only the message body of the messages that begin with KNAK and are issued by JP1/AJS3 - Web Console can be controlled by Accept-Language. The language code for the unit name, comment, execution result details, and inherit result that are contained in the message cannot be controlled.</p> | -- |

Legend:

Y: Required

--: Optional

Message body

Specify the input information in JSON format. Use UTF-8 for the character encoding.

6.4.2 Example of specifying a request

An example request is shown below, in which the unit list acquisition API is used and the following settings are specified.

Table 6–8: Contents of the request

| Item | Setting |
|-------------------------------------|--|
| API | Unit list acquisition API |
| Conditions for specifying the unit | Manager host name: ManagerHostA Scheduler service name: AJSROOT1 Full name of the upper unit: /jobgroupA |
| Host name of the Web Console server | HostA |
| Port number | 22252 |
| JP1 user name | user |
| Password | password |

Example

```
GET /ajs/api/v1/objects/statuses?mode=search&manager=ManagerHostA&serviceName=AJSROOT1&location=/jobgroupA HTTP/1.1
Host: HostA:22252
X-AJS-Authorization: dXNlcjpwYXNzd29yZA==
```

6.5 Response format

This section describes the format of a response when the response is successfully acquired, and when an error occurs.

A response consists of the status line, response header, and message body. A response is returned in the following format:

```
httpVersionΔstatusCodeΔreasonPhrase
responseHeader

messageBody
```

Legend:

Δ: space

Table 6–9: Entries and meanings of the response format

| Category | Entry | Setting |
|----------------|-----------------------|-------------------------------------|
| Status line | <i>httpVersion</i> | Protocol version |
| | <i>statusCode</i> | Status code |
| | <i>reasonPhrase</i> | Text description of the status code |
| Request Header | <i>responseHeader</i> | Response header |
| Message Body | <i>messageBody</i> | Message body |

6.5.1 Format of a response when the response is successfully acquired

The following describes the format of a response when the response is successfully acquired.

(1) Details of the response

The following describes the values returned as the response.

Protocol version

The fixed value HTTP/1.1 is returned.

Status code

A status code that indicates the processing result is returned. For details, see the description for each API.

Text description of the status code

A text description of the status code that indicates the processing result is returned. Note that text descriptions of status codes might have been omitted.

Response header

The following table lists and describes the response headers.

Table 6–10: List of response headers

| Response header | Description |
|-----------------|---|
| Cache-Control | These response headers control the cache of the response information. |
| Pragma | |

| Response header | Description |
|-----------------|---|
| Expires | These response headers control the cache of the response information. |
| Content-Type | Response data format. The fixed value <code>application/json</code> is returned. |

Message body

Output information is returned in JSON format. UTF-8 is used for the character encoding.

(2) Example response (message body)

The following shows an example response (message body) for when the unit list acquisition API is issued and the response is successfully acquired:

```
{
  "statuses": [
    {
      "definition": {
        "unitName": "/jobgroupA/jobnetA",
        "simpleUnitName": "jobnetA",
        "unitComment": "test",
        ...
      },
      "unitStatus": {
        "unitName": "/jobgroupA/jobnetA",
        "simpleUnitName": "jobnetA",
        "execID": "@A101",
        ...
      },
      "release": {
        "releaseID": "AJS_AUTO",
        ...
      }
    }
  ],
  "all": true
}
```

6.5.2 Response format when an error occurs in an API

The following describes individual elements of the response when an error occurs in an API.

(1) Details of the response

The following describes the values returned as the response.

Protocol version

The fixed value `HTTP/1.1` is returned.

Status code

A status code that indicates the processing result is returned. For details, see the description for each API.

Text description of the status code

A text description of the status code that indicates the processing result is returned. Note that text descriptions of status codes might have been omitted.

Response header

The following table lists and describes the response headers.

Table 6–11: List of response headers

| Response Header | Description |
|-----------------|---|
| Cache-Control | These response headers control the cache of the response information. |
| Pragma | |
| Expires | |
| Content-Type | Response data format. The fixed value <code>application/json</code> is returned. |

Message body

Error information is returned in JSON format. UTF-8 is used for the character encoding. The following shows details of the error information.

Format of the error information:

```
{
  "errorSource": "URI-where-an-error-occurred"
  "message": "message-body",
  "messageID": "message-ID",
  "application": "application-information",
  "extensions": [
    additional-information-of-the-error, ...
  ]
}
```

Members of the error information:

| Member name | Data type | Description |
|--------------------------|-----------|--|
| <code>errorSource</code> | string | The URI where an error occurred is returned. |
| <code>message</code> | string | The message body is returned. |
| <code>messageID</code> | string | The message ID is returned. |
| <code>application</code> | string | The application information is returned. The fixed value <code>ajs</code> is returned. |
| <code>extensions</code> | object | The additional information of the error is returned in array format. |

Format of the additional information of the error:

```
{
  "key": "key-name-of-the-additional-information",
  "value": value-for-the-key-for-the-additional-information,
}
```

Members of the additional error information:

| Member name | Data type | Description |
|------------------|-----------|---|
| <code>key</code> | string | The key name of the additional information is returned. |

| Member name | Data type | Description |
|-------------|-----------|--|
| value | string | The value corresponding to the key for the additional information is returned. |

(2) Example response (message body)

The following shows an example response (message body) when the query string (mandatory) is not specified:

```
{
  "errorSource": "/ajs/api/v1/objects/statuses",
  "message": "Specify the scheduler service name.",
  "messageID": "KNAK3201-E",
  "application": "ajs",
  "extensions": [
    {
      "key": "error_type",
      "value": "PARAMETER"
    },
    {
      "key": "error_code",
      "value": "ERROR_PARAM_EMPTY"
    },
    {
      "key": "error_parameter",
      "value": "serviceName"
    }
  ]
}
```

6.5.3 Response format when an error occurs for a reason other than APIs

The following describes individual elements of the response when an error occurs for a reason other than APIs (for example, the request format is invalid or Web Console server is not running).

(1) Details of the response

The following describes the values returned as the response.

Protocol version

The fixed value HTTP/1.1 is returned.

Status code

A status code that indicates the processing result is returned. For details, see the description for each API.

Text description of the status code

A text description of the status code that indicates the processing result is returned. Note that text descriptions of status codes might have been omitted.

Message body

Output information is returned in HTML format or plain text format.

6.6 API configuration components

API configuration components include APIs, resources, objects, and constants. This section shows the list of individual configuration components.

6.6.1 List of API configuration components

The following lists and describes the APIs, resources, objects, and constants.

(1) List of APIs

The following table lists and describes the APIs that can be used.

Table 6–12: List of APIs

| No. | Category | API | Description | API type | See |
|-----|---|--|---|----------|------------------------|
| 1 | Unit information acquisition | Unit list acquisition | Acquires information about the jobnet groups, jobnets, and jobs of the specified unit or under the specified unit. | SC-004 | 7.1.1 |
| 2 | | Unit information acquisition | Acquires information about the specified unit. | SC-007 | 7.1.2 |
| 3 | | Execution result details acquisition | Acquires details about the job for which execution has ended. | SC-010 | 7.1.3 |
| 4 | | Wait condition status list acquisition | Acquires a list of the wait conditions for the specified unit and the statuses of the units that are specified in the wait conditions as the units whose end is to be waited for. | SC-046 | 7.1.4 |
| 5 | Execution registration of a jobnet and cancellation of the execution registration | Planned execution | Performs planned execution registration of the specified jobnet. | SC-017 | 7.1.5 |
| 6 | | Fixed execution | Performs fixed execution registration of the specified jobnet. | SC-018 | 7.1.6 |
| 7 | | Immediate execution | Performs immediate execution registration of the specified jobnet. | SC-019 | 7.1.7 |
| 8 | | Registration cancellation | Cancels the execution registration of the specified jobnet for which execution registration has been performed. | SC-020 | 7.1.8 |
| 9 | Unit operation | Change hold attribute | Changes the hold attribute of the specified jobnet or job. | SC-012 | 7.1.9 |
| 10 | | Change delay monitor | Temporarily changes the delay monitoring settings for the specified jobnet registered for execution. | SC-024 | 7.1.10 |
| 11 | | Change job status | Changes the status of the specified job. | SC-025 | 7.1.11 |
| 12 | | Change plan (change time) | Temporarily changes the scheduled execution start time of the specified jobnet registered for execution. | SC-026 | 7.1.12 |

| No. | Category | API | Description | API type | See | |
|-----|--|---------------------------------------|--|---|------------------------|------------------------|
| 13 | Unit operation | Change plan (execute immediately) | Temporarily changes the execution schedule of the specified jobnet registered for execution, and then immediately executes the jobnet. | SC-027 | 7.1.13 | |
| 14 | | Change plan (execution prohibited) | Temporarily changes the execution schedule of the specified jobnet registered for execution, and then prohibits execution. | SC-028 | 7.1.14 | |
| 15 | | Change plan (release change) | Releases the temporary change in the execution schedule of the unit to resume according to the information before the change. | SC-029 | 7.1.15 | |
| 16 | | Interrupt | Interrupts the specified root jobnet being executed. | SC-030 | 7.1.16 | |
| 17 | | Kill | Kills the specified job and root jobnet that are being executed. | SC-031 | 7.1.17 | |
| 18 | | Rerun | Reruns the specified jobnet or job. | SC-032 | 7.1.18 | |
| 19 | | Wait status change | Temporarily changes the wait status of the specified unit. | SC-047 | 7.1.19 | |
| 20 | | Execution order control method change | Temporarily changes the execution order control method for the specified root jobnet. | SC-045 | 7.1.20 | |
| 21 | | Execution agent operation | Execution agent status list acquisition | Acquires a list of the statuses of the execution agents that are registered in the connection-destination JP1/AJS3 - Manager. | AG-001 | 7.1.21 |
| 22 | | | Execution agent status acquisition | Acquires the statuses of the execution agents that are registered in the connection-destination JP1/AJS3 - Manager. | AG-002 | 7.1.22 |
| 23 | Execution agent definition acquisition | | Acquires the definitions of the execution agents that are registered in the connection-destination JP1/AJS3 - Manager. | AG-003 | 7.1.23 | |
| 24 | Execution agent addition | | Adds an execution agent to the connection-destination JP1/AJS3 - Manager. | AG-004 | 7.1.24 | |
| 25 | Execution agent deletion | | Deletes the specified execution agent from the connection-destination JP1/AJS3 - Manager. | AG-005 | 7.1.25 | |
| 26 | Execution agent reconfiguration | | Changes the settings of an execution agent that is registered in the connection-destination JP1/AJS3 - Manager. | AG-006 | 7.1.26 | |
| 27 | Change the job transfer restriction status of an execution agent | | Changes the job transfer restriction status of an execution agent that is registered in the connection-destination JP1/AJS3 - Manager. | AG-007 | 7.1.27 | |
| 28 | Execution agent status change | | Changes the status of an execution agent that is registered in the | AG-008 | 7.1.28 | |

| No. | Category | API | Description | API type | See |
|-----|---|--|---|--|------------------------|
| 28 | Execution agent operation | Execution agent status change | connection-destination JP1/AJS3 - Manager. | AG-008 | 7.1.28 |
| 29 | | Checks the communication status of the job distribution delay reduction function | Checks the communication status of the job distribution delay reduction function on the connection-destination JP1/AJS3 - Manager host. | AG-016 | 7.1.29 |
| 30 | | Execution agent group status list acquisition | Acquires a list of the statuses of the execution agent groups that are registered in the connection-destination JP1/AJS3 - Manager. | AG-009 | 7.1.30 |
| 31 | | Execution agent group definition acquisition | Acquires the definitions of the execution agent groups that are registered in the connection-destination JP1/AJS3 - Manager. | AG-010 | 7.1.31 |
| 32 | | Execution agent group addition | Adds an execution agent group to the connection-destination JP1/AJS3 - Manager. | AG-011 | 7.1.32 |
| 33 | | Execution agent group deletion | Deletes the specified execution agent group from the connection-destination JP1/AJS3 - Manager. | AG-012 | 7.1.33 |
| 34 | | Execution agent group reconfiguration | Changes the settings of an execution agent group that is set in the connection-destination JP1/AJS3 - Manager. | AG-013 | 7.1.34 |
| 35 | | Changes the job transfer restriction status of an execution agent group | Changes the job transfer restriction status of an execution agent group that is registered in the connection-destination JP1/AJS3 - Manager. | AG-014 | 7.1.35 |
| 36 | | Exclude or add execution agents, or to change their priority levels | Excludes or adds execution agents for an execution agent group that is registered in the connection-destination JP1/AJS3 - Manager, or changes the priority level of such execution agents. | AG-015 | 7.1.36 |
| 37 | | Other | Version information acquisition | Acquires the version information of the product. | OT-003 |
| 38 | JP1/AJS3 - Manager protocol version acquisition | | Acquires the protocol version of connection-destination JP1/AJS3 - Manager. | OT-005 | 7.1.38 |

(2) List of resources

The following table lists and describes the resources that can be used.

Table 6–13: List of resources

| No. | Resource | Description | See |
|-----|--------------------------------|---|-----------------------|
| 1 | Resource for status monitoring | Indicates the unit for status monitoring, or generation information. The resource for status monitoring contains the following objects: <ul style="list-style-type: none"> • Unit definition information • Status information | 7.2.1 |

| No. | Resource | Description | See |
|-----|--------------------------------|---|-----------------------|
| 1 | Resource for status monitoring | <ul style="list-style-type: none"> Release information | 7.2.1 |
| 2 | Resource for unit definition | Indicates the resource for unit definition. This resource is specified for the API for which execution registration of the jobnet is performed. | None |

(3) List of objects

The following table lists and describes the objects that can be used.

Table 6–14: List of objects

| No. | Object | Description | See |
|-----|--|---|-----------------------|
| 1 | Unit definition information | Indicates the unit definition information, such as the unit name and unit type. | 7.3.1 |
| 2 | Status information | Indicates the status information of a unit, such as the start time and status. | 7.3.2 |
| 3 | Release information | Indicates the release information of a unit, such as the release date and release ID. | 7.3.3 |
| 4 | Start condition parameter | Indicates the setting values, such as the count and time in the start condition. | 7.3.4 |
| 5 | Macro variable | Indicates the macro variable name and passing information. | 7.3.5 |
| 6 | Execution agent operation result | Indicates the result of operating an execution agent or execution agent group. | 7.3.6 |
| 7 | Execution agent definition information | Indicates the definition information of an execution agent or execution agent group. | 7.3.7 |
| 8 | Execution agent status | Indicates the status of an execution agent or execution agent group. | 7.3.8 |

(4) List of constants

The following table lists and describes the constants that can be used.

Table 6–15: List of constants

| No. | Category | Constant | Description | See |
|-----|---|------------------|--|-----------------------|
| 1 | Constant commonly used by various APIs | DateType | Indicates the type of specifying the start and end times. | 7.4.1 |
| 2 | | Status | Indicates the unit status. | |
| 3 | | DelayStart | Indicates whether the start delayed. | |
| 4 | | DelayEnd | Indicates whether the end delayed. | |
| 5 | Constants used by the unit list acquisition API | LowerType | Indicates how to acquire the units under the specified unit. | 7.4.2 |
| 6 | | SearchTargetType | Indicates the range of the units to be acquired. | |
| 7 | | MatchMethods | Indicates how to collate the character string. | |
| 8 | | UnitType | Indicates the unit type. | |
| 9 | | GenerationType | Indicates how to acquire the generation. | |
| 10 | | UnitStatus | Indicates the unit status. | |

| No. | Category | Constant | Description | See |
|-----|--|--------------------------|--|-----------|
| 11 | Constants used by the unit list acquisition API | DelayType | Indicates whether the start delay or end delay is specified. | 7.4.2 |
| 12 | | HoldPlan | Indicates whether there is a hold plan. | |
| 13 | | ReleaseInfoSearchMethods | Indicates how to acquire release information. | |
| 14 | Constant used by the execution registration API | PlannedTimePassedType | Indicates the execution timing of the unit for which the planned time has passed when the scheduler service starts and when the execution registration is performed. | 7.4.3 |
| 15 | Constants used by the unit definition information object | Type | Indicates the unit type. | 7.4.4 |
| 16 | | RegisterStatus | Indicates the registration status of the unit. | |
| 17 | Constants used by the status information object | ChangeType | Indicates whether the plan was temporarily changed. | 7.4.5 |
| 18 | | HoldAttr | Indicates the hold attribute. | |
| 19 | | TimeType | Indicates the time type for the valid range of start condition. | |
| 20 | | Waiting | Indicates whether there are wait conditions that have not been met. | |
| 21 | | DelayMonitor | Indicates the method of monitoring delays for jobnets. | |
| 22 | | MonitoringJobnet | Indicates the method of monitoring end delays based on the time required for jobnet execution. | |
| 23 | | ExecOrderMethod | Indicates the execution order control method of a jobnet. | |
| 24 | Constant used by the release information object | ReleaseStatus | Indicates the release status. | 7.4.6 |
| 25 | Constant used by the start condition parameter object | TimeType | Indicates the time type for the valid range of start condition. | 7.4.7 |
| 26 | Constant used for changing the hold attribute | ChangeHoldAttr | Indicates a change in the hold attribute. | 7.4.8(1) |
| 27 | Constants used for temporarily changing a plan | ChangeStartTimeType | Indicates the type of execution start time when the plan is temporarily changed. | 7.4.9(1) |
| 28 | | ChangePushedAheadType | Indicates how the schedule is pushed ahead when the plan is temporarily changed. | 7.4.9(2) |
| 29 | | ChangeLowerType | Indicates whether to change the start time of lower jobnets when the plan is temporarily changed. | 7.4.9(3) |
| 30 | Constants used by the rerun API | RootRerunType | Indicates how to rerun a root jobnet. | 7.4.10(1) |
| 31 | | RerunType | Indicates how to rerun a nested jobnet or job. | 7.4.10(2) |
| 32 | | RerunOption | Indicates the rerun option. | 7.4.10(3) |
| 33 | Constants used for changing delay monitoring | DelayMonitorType | Indicates the method of monitoring delays for jobnets. | 7.4.11(1) |
| 34 | | MonitoringJobnetType | Indicates the method of end delay monitoring based on the time required for executing the jobnet. | 7.4.11(2) |

| No. | Category | Constant | Description | See |
|-----|---|-----------------------|---|---------------------------|
| 35 | Constant used for job status change | ChangeStatus | Indicates the job status after the change. | 7.4.12(1) |
| 36 | Constants used for waiting | WaitMethod | Indicates the conditions under which a unit can wait. | 7.4.13 |
| 37 | | WaitingAction | Indicates the behavior of a unit with wait conditions. | |
| 38 | | WaitingStatus | Indicates a unit with wait conditions and the statuses of the units whose end is being waited for. | |
| 39 | | WaitingStatusAction | Indicates whether to waiting is enabled or disabled. | |
| 40 | Constants used for execution agent objects | ExecAgentStatus | Indicates the job transfer restriction status of an execution agent or execution agent group. | 7.4.14 |
| 41 | | ComStatus | Indicates the status of an execution agent. | |
| 42 | Constants used by the execution order control method change API | ChangeExecOrderMethod | Indicates the new execution order control method to which the current method is to be changed. | 7.4.15 |
| 43 | Constant used by the unit information acquisition API | ConnectInfoType | Indicates whether to obtain connection information when obtaining the Status information object (unitStatus) of the Resource for status monitoring. | 7.4.16 |

6.7 Notes on using APIs

This section gives notes on using APIs.

6.7.1 Workload on JP1/AJS3 - Manager

Depending on the number of units that the API operates on and the system configuration, the workload on JP1/AJS3 - Manager might be increased. The following describes what kind of operations might increase the workload on JP1/AJS3 - Manager, and the actions to be taken to solve the problems.

- When many users execute processing at the same time

When multiple users issue API requests to the scheduler service of the same JP1/AJS3 - Manager program, multiple processing tasks are executed on JP1/AJS3 - Manager. If too many APIs are requested for processing, the processing takes time or an excessive workload is placed on JP1/AJS3 - Manager. In such a case, limit the number of users who can perform operations (limit the maximum number of simultaneous sessions). For details about the maximum number of simultaneous sessions, see *20.4.2(21) CDMAXSESSION* in the *JP1/Automatic Job Management System 3 Configuration Guide*.

- When API requests are frequently issued

If API requests are issued frequently, processing must be executed frequently on APIs, so workload is continuously placed on JP1/AJS3 - Manager. Therefore, if user applications repeatedly issue API requests in your system, re-design the system so that API requests are not frequently issued.

- When there are many units and generations

If there are many units under the unit for which API requests are to be issued, or if the units have many generations, a heavy load might be placed on JP1/AJS3 - Manager for API processing. The APIs that might place a load on JP1/AJS3 - Manager and the operation conditions are described below. For each API, consider the load on JP1/AJS3 - Manager, and determine the number of units to be processed and the number of generations.

- Fixed execution registration API

If there are many units under the root jobnet, or if many generations are subject to execution registration, a heavy load might result.

- Registration cancellation API

If execution registration has been performed for many generations, or if there are many units in the target jobnet, a heavy load might result.

- Unit list acquisition API

If many units are subject to acquisition, a heavy load might result.

Supplementary note

You can set a connection timeout for when it takes time to establish a connection between the Web Console server and JP1/AJS3 - Manager or to receive a response. The timeout time can be set in the network-settings file in the Web Console server, or by using the `CDESSIONTIMEOUT` environment setting parameter of JP1/AJS3 - Manager. The following values are set by default:

Network-settings file in the Web Console server

Connection timeout time: None

Receive timeout time: 180 seconds

`CDESSIONTIMEOUT` environment setting parameter of JP1/AJS3 - Manager

Connection timeout time: 180 seconds

For details about the network-settings file, see *3.4.4 Details on the settings in the network-settings file (ajscd_ajs3web.properties)* in the *JP1/Automatic Job Management System 3 Configuration Guide*.

For details about the `CDESSIONTIMEOUT` environment setting parameter, see *20.4.2(104) CDESSIONTIMEOUT* in the *JP1/Automatic Job Management System 3 Configuration Guide*.

6.7.2 Setting SSL communication

How to set up SSL communication (when you use SSL communication for calling APIs from user applications) depends on the programming language you use. Specify the settings by using the procedure provided by each programming language. You also need to specify settings for the Web Console server when using SSL communication. For details, see *2.3.6 Encryption of JP1/AJS3 communications with SSL* in the *JP1/Automatic Job Management System 3 System Design (Configuration) Guide*.

6.7.3 JP1 user permissions for the operation-target unit

When an operation is performed, such as execution registration, the JP1 user needs execution permission for the target unit. Also, to acquire unit information, the JP1 user needs view permission. If you try to perform an operation, such as execution registration, on a unit for which you do not have execution permission, you cannot perform the operation. If you try to acquire unit information, you can acquire information only about the units for which you have the view permission. For the execution permission necessary for executing each API, see the description for each API.

Supplementary notes

- For the JP1 users to be used, user mapping must be set beforehand.
- All JP1 users can operate and view the units for which a JP1 resource group is not set.

6.7.4 Characters that can be used in API arguments

For API argument names (such as the unit name and scheduler service name), you can use the same types of characters as for JP1/AJS3 - Manager. For the character encoding, you can use UTF-8 for the request and response. For requests, use data without BOM.

For details about the characters that can be used for a unit name, see *B.3 Limits for units* in the *JP1/Automatic Job Management System 3 System Design (Configuration) Guide*. For details about the range of characters that can be used, see *2.4.2 Language type and character encoding of the system* in the *JP1/Automatic Job Management System 3 System Design (Configuration) Guide*.

6.7.5 Number of bytes of API arguments

The number of bytes that can be used for API arguments depends on the connection-target JP1/AJS3 - Manager.

If JP1/AJS3 - Manager is running in a UNIX environment and UTF-8 is used for the character encoding, the number of characters that can be specified becomes fewer than when Shift-JIS is used for character encoding. However, you can change the number of characters that can be specified (for example, for the unit name) in the UTF-8 environment. If you specify `sjis` for the `DEFLENTYPE` environment setting parameter, you can use the same number of characters as can be used in the Shift-JIS environment. For details about the setting for changing the number of characters that can be specified

for the unit name in the UNIX UTF-8 environment, see *15.1.10 Setting for changing the number of characters specifiable for a unit name in a UTF-8 environment* in the *JP1/Automatic Job Management System 3 Configuration Guide*.

6.7.6 Managing the execution ID of the operation-target unit

For the API to be used to perform an operation on a jobnet for which execution registration has been performed, or for the API to be used to view unit information, specify the execution ID as an argument. Therefore, user applications must properly manage the execution IDs acquired from APIs.

You can acquire the execution IDs by the following APIs:

- Unit list acquisition
- Fixed execution registration (when an execution schedule is added with the date and time specified)
- Immediate execution registration

6.7.7 Status code if the request format is invalid

If the request format is invalid, the status code 500 might be returned. The following lists typical examples:

- A multi-byte character is used in a request line or request header.
- URL encoding contains an error.
- The value of a request header is invalid.
- The size of the message body that must be specified is 0 byte.
- The message body contains BOM.

6.7.8 Language type of maintenance information and stack trace information in the message body

Maintenance information and stack trace information indicated in the message body might follow the language type of the OS. Therefore, messages might contain a language that is different from the language type specified in the `Accept-Language` request header or the language type of messages specified in the environment settings file.

6.7.9 Response message body

The members of the message body in the response can increase if, for example, JP1/AJS3 - Web Console is upgraded. The following members are subject to increase:

- Members of the message body
- Members of the resource
- Members of the object
- Values defined for constants

If you use a user application to use the API, you need to program the user application on the assumption that the members in the message body will increase. For example, if the user application is programmed so that an error occurs if a nonexistent member is found when JSON data is converted to objects, the user application might run abnormally if the members of JSON data increase.

6.7.10 Connection permission for the JP1/AJS3 - Manager instances to which requests are to be issued

If the Web Console server uses the function for restricting the connection-destination JP1/AJS3 - Manager instances, make sure that you have permission to connect to the JP1/AJS3 - Manager instances to which you want to issue requests. If you issue a request from a user application to a JP1/AJS3 - Manager instance to which you do not have permission to connect, an error will occur because you will not be able to log in to JP1/AJS3 - Manager.

The function for restricting connection-destination JP1/AJS3 - Manager instances is set in the environment settings file (`ajs3web.conf`) of the Web Console server. For details about the environment settings file (`ajs3web.conf`) in Windows, see *3.4.3 Details on the settings in the environment-settings file (ajs3web.conf)* in the *JP1/Automatic Job Management System 3 Configuration Guide*. For details about the environment settings file (`ajs3web.conf`) in Linux, see *13.3.3 Details on settings in the environment-settings file (ajs3web.conf)* in the *JP1/Automatic Job Management System 3 Configuration Guide*.

6.7.11 Notes on upgrading from a version earlier than 12-60

A status code is returned as an API response. Text descriptions of status codes that were output in version 12-60 or earlier might be omitted in version 13-00 or later.

This might affect user applications that perform judgments based on status codes with text descriptions for versions of JP1/AJS3 - Web Console earlier than 12-60. You must modify the judgment processing of such user applications when you upgrade to version 13-00 or later.

7

Details of API Configuration Components

This chapter describes APIs, resources, objects, and constants.

7.1 Details of APIs

This section describes the formats and details of the individual APIs released for JP1/AJS3.

7.1.1 Unit list acquisition API

This API acquires information about the job groups, jobnets, and jobs of a specified unit or under that unit. Specify the unit whose information you want to acquire, by writing conditions. If you write multiple conditions, a list of units that satisfy all conditions is acquired.

If no units satisfy the conditions, a unit list containing no units is returned. Information of the units for which the login JP1 user does not have view permission is not included in the acquisition result. The maximum number of information units that can be acquired is 1,000. If the number of units to be acquired exceeds 1,000, change the conditions to reduce the number of units to be acquired.

Execution privileges

The logged in user must have one of the following JP1 permissions for the unit whose information is to be acquired:

- JP1_AJS_Admin privileges
- JP1_AJS_Manager privileges
- JP1_AJS_Editor privileges
- JP1_AJS_Operator privileges
- JP1_AJS_Guest privileges

Request format

Request line

```
GET /application/component/apiVersion/objects/statuses?query httpVersion
```

API version

v1

Information that uniquely identifies a resource

None

Parameter

The following table lists and describes the parameters that can be specified for `query`.

Table 7–1: List of parameters for the unit list acquisition API

| Parameter | Description of the value | Required? |
|-------------|--|-----------|
| mode | Specify the fixed value search. | Y |
| manager | Specify the manager host name or IP address by using a character string in the range from 1 to 255 bytes. | Y |
| serviceName | Specify the scheduler service name by using a character string in the range from 1 to 30 bytes. | Y |
| location | Specify the full name of the upper unit (job group or jobnet) of the unit whose information you want to acquire, by using a character string in the range from 1 to 930 bytes. | Y |

| Parameter | Description of the value | Required? |
|----------------------|--|-----------|
| searchLowerUnits | <p>Specify whether to acquire the information of the units directly under the unit specified for the <code>location</code> parameter or the information of all units under that specified unit, by using a character string constant specified for the <code>LowerType</code> constant. For details about the <code>LowerType</code> constant, see 7.4.2(1) LowerType.</p> <p>If you do not specify this parameter, <code>NO</code> (the units directory under the specified unit) is assumed.</p> | Y |
| searchTarget | <p>Specify whether to acquire only the definition of the unit or both the definition and status of the unit, by using a character string constant specified for the <code>SearchTargetType</code> constant. For details about the <code>SearchTargetType</code> constant, see 7.4.2(2) SearchTargetType.</p> <p>If you specify <code>DEFINITION</code> (definition), the settings for the following parameters are ignored:</p> <ul style="list-style-type: none"> • <code>execID</code> • <code>generation</code> • <code>periodBegin</code> • <code>periodEnd</code> • <code>status</code> • <code>delayStatus</code> • <code>holdPlan</code> • <code>execHost</code> • <code>execHostMatchMethods</code> <p>If you do not specify this parameter, <code>DEFINITION_AND_STATUS</code> (definition and status) is assumed.</p> | -- |
| unitName | <p>Specify the name of the unit whose information you want to acquire.</p> <p>You can specify this parameter only when you specify the unit name comparison method by using the <code>unitNameMatchMethods</code> parameter. If you specify <code>NO</code> (do not use for the search condition) for the unit name comparison method, this parameter setting is ignored.</p> <p>The number of bytes that can be specified for the unit name differs, depending on the value specified for the <code>unitNameMatchMethods</code> parameter.</p> <p>The following shows the values that can be specified for the <code>unitNameMatchMethods</code> parameter, and the number of bytes that can be specified for this parameter:</p> <p><code>EQ, BW, EW, NE, CO, NC</code>: 1 to 30 bytes</p> <p><code>RE</code>: 1 to 64 bytes</p> | -- |
| unitNameMatchMethods | <p>Specify how to compare the unit name, by using a character string constant specified for the <code>MatchMethods</code> constant. For details about the <code>MatchMethods</code> constant, see 7.4.2(3) MatchMethods. If you specify <code>NO</code> (do not use for the search condition), all unit names will be acquired.</p> <p>If you do not specify this parameter, <code>NO</code> is assumed.</p> | -- |
| execID | <p>Specify the execution ID of the unit whose information you want to acquire, in the format of <code>@[mmmm]{A to Z}nnnn</code> (for example, <code>@10A200</code>).</p> <p>You can specify this parameter only when you specify <code>EXECID</code> (acquire the generation of the specified execution ID) for the <code>generation</code> parameter. If you specify another value, this parameter setting is ignored.</p> | -- |
| unitType | <p>Specify the type of the unit whose information you want to acquire, by using a character string constant specified for the <code>UnitType</code> constant. For details about the <code>UnitType</code> constant, see 7.4.2(4) UnitType.</p> <p>If you specify <code>NO</code> (do not use for the search condition), all unit types will be acquired.</p> <p>If you specify <code>GROUP</code> (such as a job group), the settings for the following parameters are ignored:</p> <ul style="list-style-type: none"> • <code>execID</code> • <code>generation</code> | -- |

| Parameter | Description of the value | Required? |
|-------------|---|-----------|
| unitType | <ul style="list-style-type: none"> • periodBegin • periodEnd • status • delayStatus • holdPlan • execHost • execHostMatchMethods • releaseID • releaseInfoSearchMethods <p>If you specify ROOT (such as the root jobnet) or NET (such as a jobnet), the settings for the following parameters are ignored:</p> <ul style="list-style-type: none"> • execHost • execHostMatchMethods <p>If you do not specify this parameter, NO is assumed.</p> | -- |
| generation | <p>Specify the generation of the unit whose information you want to acquire, by using a character string constant specified for the GenerationType constant. For details about the GenerationType constant, see 7.4.2(5) <i>GenerationType</i>.</p> <p>If you do not specify this parameter, STATUS (latest status) is assumed.</p> | -- |
| periodBegin | <p>Specify the start time of the generation of the unit whose information you want to acquire, in the YYYY-MM-DDThh:mm format. The generations that exist after the specified time will be acquired.</p> <p>You can specify the following values:</p> <ul style="list-style-type: none"> • YYYY: Specify the year. The following are the possible values for the year: If the version of JP1/AJS3 - Web Console is 13-00 or later and the version of the connection-destination JP1/AJS3 - Manager is 13-00 or later: 1994 to the value specified for the SCHEDULELIMIT environment setting parameter (unit: year)[#] In cases other than the above: 1994 to 2036 (unit: year) • MM: Specify the month. You can specify the month in the range from 01 to 12 (unit: month). • DD: Specify the day. You can specify the day in the range from 01 to the last day of the specified month (unit: day). • hh: Specify the hour. You can specify the hour in the range from 00 to 23 (unit: hour). • mm: Specify the minute. You can specify the minute in the range from 00 to 59 (unit: minute). <p>Specify the date by using the local date for the scheduler service of the request-destination JP1/AJS3 - Manager.</p> <p>You can specify this parameter only when you specify PERIOD (specify period) for the generation parameter. If you specify another value, this parameter setting is ignored. The end time of the period is specified for the periodEnd parameter.</p> <p>Specify a time that is earlier than the end time specified for the periodEnd parameter.</p> | -- |
| periodEnd | <p>Specify the end time of the generation of the unit whose information you want to acquire, in the YYYY-MM-DDThh:mm format. The generations that exist before the specified time will be acquired.</p> <p>You can specify the following values:</p> <ul style="list-style-type: none"> • YYYY: Specify the year. The following are the possible values for the year: | -- |

| Parameter | Description of the value | Required? |
|-------------|---|-----------|
| periodEnd | <p>If the version of JP1/AJS3 - Web Console is 13-00 or later and the version of the connection-destination JP1/AJS3 - Manager is 13-00 or later: 1994 to the value specified for the SCHEDULELIMIT environment setting parameter (unit: year)[#]</p> <p>In cases other than the above: 1994 to 2036 (unit: year)</p> <ul style="list-style-type: none"> • <i>MM</i>: Specify the month. You can specify the month in the range from 01 to 12 (unit: month). • <i>DD</i>: Specify the day. You can specify the day in the range from 01 to the last day of the specified month (unit: day). • <i>hh</i>: Specify the hour. You can specify the hour in the range from 00 to 23 (unit: hour). • <i>mm</i>: Specify the minute. You can specify the minute in the range from 00 to 59 (unit: minute). <p>Specify the date by using the local date for the scheduler service of the request-destination JP1/AJS3 - Manager.</p> <p>Specify this parameter only if you specify PERIOD (specify period) for the generation parameter. If you specify another value, this parameter setting is ignored.</p> <p>Specify the start time of the period by using the periodBegin parameter.</p> <p>Specify a time that is equal to or later than the start time specified for the periodBegin parameter.</p> | -- |
| status | <p>Specify the status of the unit whose information you want to acquire, by using a character string constant specified for the UnitStatus constant. For details about the UnitStatus constant, see 7.4.2(6) UnitStatus.</p> <p>If you specify NO (do not use for the search condition), all unit statuses will be acquired.</p> <p>If you specify UNREGISTERED (unregistered), the settings for the following parameters are ignored:</p> <ul style="list-style-type: none"> • execID • generation • periodBegin • periodEnd • delayStatus • holdPlan • execHost • execHostMatchMethods <p>When you specify UNREGISTERED (unregistered), if you are using the jobnet release function, multiple information sets might be acquired for a unit name. In such a case, specify the releaseInfoSearchMethods and releaseID parameters to identify the acquisition target.</p> <p>If you do not specify this parameter, NO is assumed.</p> | -- |
| delayStatus | <p>Specify the delay status of the unit whose information you want to acquire, by using a character string constant specified for the DelayType constant. For details about the DelayType constant, see 7.4.2(7) DelayType.</p> <p>If you do not specify this parameter, NO (delay is not considered in the search condition) is assumed.</p> | -- |
| holdPlan | <p>Specify whether there is a hold plan for the unit whose information you want to acquire, by using a character string constant specified for the HoldPlan constant. For details about the HoldPlan constant, see 7.4.2(8) HoldPlan.</p> <p>If you specify PLAN_YES (there is a hold plan), information of the generations whose processing is waiting for execution, being held, or has finished will be acquired. In this case, information of the generations whose processing has finished will also be acquired,</p> | -- |

| Parameter | Description of the value | Required? |
|-------------------------|---|-----------|
| holdPlan | <p>so information of the generations whose processing is held at re-execution will also be acquired. If you acquire information only of the specified generations (for example, whose processing is waiting for execution or finished execution), specify the <code>generation</code> and <code>status</code> parameters simultaneously to identify the generations whose information will be acquired.</p> <p>If you do not specify this parameter, <code>NO</code> (hold plan is not considered in the search condition) is assumed.</p> | -- |
| unitComment | <p>Specify the comment for the unit whose information you want to acquire.</p> <p>You can specify this parameter only when you specify the comment comparison method by using the <code>unitCommentMatchMethods</code> parameter. If you specify <code>NO</code> (do not use for the search condition) for the comment comparison method, this parameter setting is ignored. If you specify <code>EQ</code> (perfect match) for the comment comparison method, and a null character string (0 bytes) for this parameter, the units for which no comment is defined will be acquired.</p> <p>The number of bytes that can be specified for the comment differs, depending on the value specified for the <code>unitCommentMatchMethods</code> parameter.</p> <p>The following shows the values that can be specified for the <code>unitCommentMatchMethods</code> parameter, and the number of bytes that can be specified for this parameter:</p> <p><code>EQ, NE</code>: 0 to 80 bytes <code>BW, EW, CO, NC</code>: 1 to 80 bytes <code>RE</code>: 1 to 164 bytes</p> | -- |
| unitCommentMatchMethods | <p>Specify how to collate the comment of the unit, by using a character string constant specified for the <code>MatchMethods</code> constant. For details about the <code>MatchMethods</code> constant, see 7.4.2(3) MatchMethods.</p> <p>If you do not specify this parameter, <code>NO</code> (do not use for the search condition) is assumed.</p> | -- |
| execHost | <p>Specify the host that executes the unit whose information you want to acquire. Specify the name of the agent host that actually executed the unit, not the execution agent defined in the unit definition.</p> <p>You can specify this parameter only when you specify how to collate the execution host name by using the <code>execHostMatchMethods</code> parameter. If you specify <code>NO</code> (do not use for the search condition) for the execution host name comparison method, this parameter setting is ignored. If you specify <code>EQ</code> (perfect match) for the execution host name comparison method, and a null character string (0 bytes) for this parameter, the jobs whose execution host has not been determined and that are waiting for execution will be acquired.</p> <p>The number of bytes that can be specified for the execution host differs, depending on the value specified for the <code>execHostMatchMethods</code> parameter.</p> <p>The following shows the values that can be specified for the <code>execHostMatchMethods</code> parameter, and the number of bytes that can be specified for this parameter:</p> <p><code>EQ, NE</code>: 0 to 255 bytes <code>BW, EW, CO, NC</code>: 1 to 255 bytes <code>RE</code>: 1 to 514 bytes</p> | -- |
| execHostMatchMethods | <p>Specify how to collate the execution host name of the unit, by using a character string constant specified for the <code>MatchMethods</code> constant. For details about the <code>MatchMethods</code> constant, see 7.4.2(3) MatchMethods.</p> <p>If you do not specify this parameter, <code>NO</code> (do not use for the search condition) is assumed.</p> | -- |
| releaseID | <p>Specify the release ID of the unit whose information you want to acquire, by using a character string in the range from 1 to 30 bytes.</p> <p>Specify this parameter only if you specify <code>ID</code> (release ID) for the <code>releaseInfoSearchMethods</code> parameter. If you specify another value, this parameter setting is ignored.</p> | -- |

| Parameter | Description of the value | Required? |
|--------------------------|---|-----------|
| releaseInfoSearchMethods | Specify how to acquire release information, by using a character string constant specified for the ReleaseInfoSearchMethods constant. For details about the ReleaseInfoSearchMethods constant, see 7.4.2(9) ReleaseInfoSearchMethods . If you specify NO (do not use for the search condition), all release information sets will be acquired. If you do not specify this parameter, NO is assumed. | -- |

Legend:

Y: Required

--: Optional

#

For details about the SCHEDULELIMIT environment setting parameter of the connection-destination JP1/AJS3 - Manager, see [20.4.2\(123\) SCHEDULELIMIT](#) in the *JP1/Automatic Job Management System 3 Configuration Guide*.

You can check the version of JP1/AJS3 - Web Console from the return value (productVersionNumber) of the version information acquisition API function. You can check the version of the connection-destination JP1/AJS3 - Manager from the return value (protocolVersionNumber) of the JP1/AJS3 - Manager protocol version acquisition API function.

For details about the version information acquisition API, see [7.1.37 Version information acquisition API](#).

For details about the JP1/AJS3 - Manager protocol version acquisition API, see [7.1.38 JP1/AJS3 - Manager protocol version acquisition API](#).

Status code

The following table lists and describes the status codes returned as a response:

| Status code | Text description | Description |
|-------------|---------------------|--|
| 200 | OK | The unit list was successfully acquired. |
| 400 | Bad Request | The query character string is invalid. |
| 401 | Unauthorized | Authentication is required. |
| 403 | Forbidden | The operator does not have execution permission. |
| 404 | Not found | The operator does not have access permission for the resource, or the resource does not exist. |
| 409 | Conflict | The processing cannot be continued because the request is inconsistent with the current resource status. |
| 412 | Precondition failed | The Web Console server is not available. |
| 500 | Server-side error | A processing error occurred in the Web Console server. |

Response format

Message Body

```
{
  "statuses": [resource-for-status-monitoring, ...],
  "all": whether-all-information-sets-could-be-acquired
}
```

Return values

If the status code is 200, the following information is returned:

| Member | Data type | Description |
|----------|-----------|---|
| statuses | object[] | Returns an array of resources for status monitoring. If there is no unit that satisfies the condition, an array with 0 elements is returned. For details about the resources for status monitoring, see 7.2.1 Resource for status monitoring . |
| all | boolean | Returns whether all information sets could be acquired. If the number of acquired units does not exceed 1,000, <code>true</code> is returned. If the number of acquired units exceeds 1,000, <code>false</code> is returned. However, the acquisition results do not contain information about units for which the login JP1 user does not have reference permission. Therefore, even if information about such units has not been acquired, <code>true</code> is returned if the number of acquired units does not exceed 1,000. |

Example

The following shows an example of using the API to acquire the unit list (latest status) directly under the job group (/JobGroup).

Example request:

```
GET /ajs/api/v1/objects/statuses?mode=search&manager=HOSTM&serviceName=
AJSROOT1&location=%2FJobGroup HTTP/1.1
Host: HOSTW:22252
Accept-Language: ja
X-AJS-Authorization: dXNlcjpwYXNzd29yZA==
```

Example response (message body):

```
{
  "statuses": [
    {
      "definition": {
        "owner": "jpladmin",
        "customJobType": "",
        "registerStatus": "YES",
        "rootJobnetName": "/JobGroup/Jobnet",
        "recoveryUnit": false,
        "unitType": "ROOTNET",
        "unitComment": "",
        "simpleUnitName": "Jobnet",
        "parameters": "",
        "execAgent": "",
        "execFileName": "",
        "wait": false,
        "jobnetReleaseUnit": false,
        "jplResourceGroup": "",
        "unitName": "/JobGroup/Jobnet",
        "unitID": 1560
      },
      "release": null,
      "unitStatus": {
        "status": "RUNNING",
        "execHost": "",
        "startDelayStatus": "NO",
        "nestStartDelayStatus": "NO",
        "endDelayStatus": "NO",
        "nestEndDelayStatus": "NO",
        "startDelayTime": "",
        "endDelayTime": ""
      }
    }
  ]
}
```

```

        "changeType": "NO",
        "registerTime": "",
        "jobNumber": -1,
        "retCode": "",
        "simpleUnitName": "Jobnet",
        "schStartTime": "2015-09-02T00:00:00+09:00",
        "reStartTime": "",
        "endTime": "",
        "holdAttr": "NO",
        "startTime": "2015-09-02T22:50:28+09:00",
        "unitName": "/JobGroup/Jobnet",
        "execID": "@A2959"
    }
}
],
"all": true
}

```

7.1.2 Unit information acquisition API

This API acquires information about a specified unit. If the user who logged in does not have reference permissions for the specified unit, the user cannot use the API to acquire information about the unit.

This API can be used only if the version of JP1/AJS3 - Web Console is 11-50 or later. Before using this API, run the version information acquisition API, and confirm that its return value (`productVersionNumber`) is 115000 or more.

Execution privileges

The logged in user must have one of the following JP1 permissions for the unit whose information is to be acquired:

- JP1_AJS_Admin privileges
- JP1_AJS_Manager privileges
- JP1_AJS_Editor privileges
- JP1_AJS_Operator privileges
- JP1_AJS_Guest privileges

Request format

Request line

```
GET /application/component/apiVersion/objects/statuses/unitName:execID?
query httpVersion
```

API version

v1

Information that uniquely identifies a resource

The table below describes the information that uniquely identifies a resource.

If a parameter is not specified or is specified incorrectly, an error with the status code 404 occurs because the resource cannot be uniquely identified.

| Information that uniquely identifies a resource | Data type | Description | Required? |
|---|-----------|---|-----------|
| <i>unitName</i> | string | Specify the full name of the unit to be requested, by using a character string in the range from 1 to 930 bytes. | Y |
| <i>execID</i> | string | Specify the execution ID by using a character string in the format of @[<i>mmm</i>] { <i>A to Z</i> } <i>nnnn</i> (for example, @10A200). | Y |

Legend:

Y: Required

Parameter

The following table lists and describes the parameters that can be specified for `query`.

Table 7–2: List of parameters for the unit information acquisition API

| Parameter | Description of the value | Required? |
|--------------------------------|--|-----------|
| <code>manager</code> | Specify the manager host name or IP address by using a character string in the range from 1 to 255 bytes. | Y |
| <code>serviceName</code> | Specify the scheduler service name by using a character string in the range from 1 to 30 bytes. | Y |
| <code>searchConnectInfo</code> | Use a character string constant specified for the <code>ConnectInfoType</code> constant to specify whether to obtain connection information, when obtaining the Status information object (<code>unitStatus</code>) of the Resource for status monitoring. For details about the <code>ConnectInfoType</code> constant, see 7.4.16(1) ConnectInfoType . If you do not specify this parameter, <code>NO</code> (do not obtain connection information) is assumed. You can specify this parameter only if the version of JP1/AJS3 - Web Console is 12-50 or later. Before you specify this parameter, execute the version number acquisition API function and confirm that the return value (<code>productVersionNumber</code>) is 125000 or larger. For details about the version information acquisition API, see 7.1.37 Version information acquisition API . | -- |

Legend:

Y: Required

--: Optional

Status code

The following table lists and describes the status codes returned as a response:

| Status code | Text description | Description |
|-------------|---------------------|--|
| 200 | OK | The unit information was successfully acquired. |
| 400 | Bad Request | The query character string is invalid. |
| 401 | Unauthorized | Authentication is required. |
| 403 | Forbidden | The operator does not have execution permission. |
| 404 | Not found | The operator does not have access permission for the resource, or the resource does not exist. |
| 409 | Conflict | The processing cannot be continued because the request is inconsistent with the current resource status. |
| 412 | Precondition failed | The Web Console server is not available. |
| 500 | Server-side error | A processing error occurred in the Web Console server. |

Response format

Response message body

```
resource-for-status-monitoring
```

Return values

If the status code is 200, the resource for status monitoring is returned. For details about the resources for status monitoring, see [7.2.1 Resource for status monitoring](#).

Example

The following shows an example of using the API to acquire the information for the specified unit.

Example request:

```
GET /ajs/api/v1/objects/statuses/%2FJobGroup%2FJobnet:@A119?manager=HOS
TM&serviceName=AJSROOT1 HTTP/1.1
Host: HOSTW:22252
Accept-Language: ja
X-AJS-Authorization: dXNlcjpwYXNzd29yZA==
```

Example response (message body):

```
{
  "definition":
  {
    "owner": "user",
    "parameters": "",
    "unitID": 29444,
    "simpleUnitName": "Jobnet",
    "unitType": "ROOTNET",
    "unitComment": "",
    "jplResourceGroup": "",
    "unitName": "/JobGroup/Jobnet",
    "customJobType": "",
    "execAgent": "",
    "execFileName": "",
    "registerStatus": "YES",
    "scenarioUnit": false,
    "recoveryUnit": false,
    "wait": false,
    "jobnetReleaseUnit": false,
    "horizontalPosition": -1,
    "verticalPosition": -1,
    "rootJobnetName": "/JobGroup/Jobnet"
  },
  "unitStatus":
  {
    "status": "NORMAL",
    "simpleUnitName": "Jobnet",
    "holdPlan": "NONE",
    "execHost": "",
    "delayedStart": "NOT",
    "holdAttr": "NO",
    "startTime": "2017-04-20T17:27:10+09:00",
    "endTime": "2017-04-20T17:27:10+09:00",
    "delayedStartTime": "",
    "delayedEnd": "NOT",
    "delayedEndTime": ""
  }
}
```

```

    "timeRequiredForExecution": "-1",
    "unitName": "/JobGroup/Jobnet",
    "execID": "@A119",
    "schStartTime": "2017-04-20T00:00:00+09:00",
    "reStartTime": "",
    "startDelayStatus": "NO",
    "nestStartDelayStatus": "NO",
    "endDelayStatus": "NO",
    "nestEndDelayStatus": "NO",
    "startDelayTime": "",
    "endDelayTime": "",
    "changeType": "NO",
    "registerTime": "",
    "jobNumber": -1,
    "retCode": "",
    "executionType": "NONE",
    "startConditionTimes": -1,
    "startConditionPeriodType": "NONE",
    "startConditionPeriod": "",
    "retryStatus": "NONE",
    "retryTimes": -1,
    "execSchedule": "NONE",
    "statusInSummary": [
        "NONE"
    ],
    "execDateBaseTime": "",
    "waiting": "NONE",
    "monitoringJobnet": "TIME_REQUIRED_FOR_EXECUTION_NO"
},
"release": null
}

```

7.1.3 Execution result details acquisition API

This API acquires execution details about a unit for which execution has ended.

For details about the execution result, see *12.3.39 Execution Result Details dialog box* in the *JPI/Automatic Job Management System 3 Operator's Guide*.

Execution privileges

The logged in user must have one of the following JPI permissions for the unit whose information is to be acquired:

- JPI_AJS_Admin privileges
- JPI_AJS_Manager privileges
- JPI_AJS_Editor privileges
- JPI_AJS_Operator privileges
- JPI_AJS_Guest privileges

Request format

Request line

```
GET /application/component/apiVersion/objects/statuses/unitName:execID/
actions/execResultDetails/invoke?query httpVersion
```

API version

v1

Information that uniquely identifies a resource

The table below describes the information that uniquely identifies a resource.

If a parameter is not specified or is specified incorrectly, an error with the status code 404 occurs because the resource cannot be uniquely identified.

| Information that uniquely identifies a resource | Data type | Description | Required? |
|---|-----------|--|-----------|
| <i>unitName</i> | string | Specify the full name of the unit to be requested, by using a character string in the range from 1 to 930 bytes. | Y |
| <i>execID</i> | string | Specify the execution ID by using a character string in the format of @[<i>mmmm</i>] { <i>A to Z</i> } <i>nnnn</i> (for example, @10A200). | Y |

Legend:

Y: Required

Parameter

The following table lists and describes the parameters that can be specified for `query`.

Table 7–3: List of parameters for the execution result details acquisition API

| Parameter | Description of the value | Required? |
|--------------------|---|-----------|
| <i>manager</i> | Specify the manager host name or IP address by using a character string in the range from 1 to 255 bytes. | Y |
| <i>serviceName</i> | Specify the scheduler service name by using a character string in the range from 1 to 30 bytes. | Y |

Legend:

Y: Required

Status code

The following table lists and describes the status codes returned as a response:

| Status code | Text description | Description |
|-------------|---------------------|--|
| 200 | OK | The execution result details were successfully acquired. |
| 400 | Bad Request | The query character string is invalid. |
| 401 | Unauthorized | Authentication is required. |
| 403 | Forbidden | The operator does not have execution permission. |
| 404 | Not found | The operator does not have access permission for the resource, or the resource does not exist. |
| 409 | Conflict | The processing cannot be continued because the request is inconsistent with the current resource status. |
| 412 | Precondition failed | The Web Console server is not available. |
| 500 | Server-side error | A processing error occurred in the Web Console server. |

Response format

Response message body

```
{
  "execResultDetails": "execution-result-details",
  "all": whether-all-information-sets-could-be-acquired
}
```

Return values

If the status code is 200, the following information is returned:

| Member | Data type | Description |
|-------------------|-----------|--|
| execResultDetails | string | Returns execution result details as a character string of no more than 5 megabytes. If the character string exceeds 5 megabytes, end characters might not be identified as characters because information exceeding 5 megabytes is truncated. Execution result details contain a linefeed code (<code>\n</code> or <code>\r\n</code>) for the environment in which the job is executed. Replace the linefeed code according to the environment in which they will be displayed. If there are no execution result details, a null character string (0 bytes) is returned. |
| all | boolean | Returns irrespective of whether all execution result details could be acquired. If all execution result details could be acquired, true is returned. If some execution result details could not be acquired, false is returned. |

Example

The following shows an example of using the API to acquire the execution result details for the specified job.

Example request:

```
GET /ajs/api/v1/objects/statuses/%2FJobGroup%2FJobnet%2FJob:%40A100/actions/execResultDetails/invoke?manager=HOSTM&serviceName=AJSROOT1 HTTP/1.1
Host: HOSTW:22252
Accept-Language: ja
X-AJS-Authorization: dXNlcjpwYXNzd29yZA==
```

Example response (message body):

```
{
  "execResultDetails": "execution-result-details",
  "all": true
}
```

7.1.4 Wait condition status list acquisition API

This API acquires a list of the wait conditions of the specified unit and the statuses of the units that are set in the wait conditions as the units to be waited for.

For details about waiting, see *2.2.5 Using wait conditions to control the order of unit execution* in the *JPI/Automatic Job Management System 3 System Design (Work Tasks) Guide*.

You can use this API function if the version of JP1/AJS3 - Web Console is 12-50 or later. Before you use this API function, execute the version number acquisition API function and confirm that the return value (`productVersionNumber`) is 125000 or larger.

Execution privileges

The logged-in JP1 user must have one of the following JP1 permissions for the unit for which a list of the statuses of wait conditions is to be acquired:

- JP1_AJS_Admin privileges
- JP1_AJS_Manager privileges
- JP1_AJS_Editor privileges
- JP1_AJS_Operator privileges
- JP1_AJS_Guest privileges

Request format

Request line

```
GET /application/component/apiVersion/objects/waiting/unitName:execID?query httpVersion
```

API version

v1

Information that uniquely identifies a resource

The table below describes the information that uniquely identifies a resource.

If a parameter is not specified or is specified incorrectly, an error with the status code 404 occurs because the resource cannot be uniquely identified.

| Information that uniquely identifies a resource | Data type | Description | Required? |
|---|-----------|--|-----------|
| <i>unitName</i> | string | Specify the full name of the unit to be requested, by using a character string in the range from 1 to 930 bytes. | Y |
| <i>execID</i> | string | Specify the execution ID by using a character string in the format of @[<i>mmmm</i>] { <i>A to Z</i> } <i>nnnn</i> (for example, @10A200). | Y |

Parameter

The following table lists and describes the parameters that can be specified for `query`.

Table 7-4: List of parameters for the Wait condition status list acquisition API

| Parameter | Description of the value | Required? |
|--------------------|---|-----------|
| <i>manager</i> | Specify the manager host name or IP address by using a character string in the range from 1 to 255 bytes. | Y |
| <i>serviceName</i> | Specify the scheduler service name by using a character string in the range from 1 to 30 bytes. | Y |

Status code

The following table lists and describes the status codes returned as a response:

| Status code | Text description | Description |
|-------------|------------------|---|
| 200 | OK | A list of the statuses of wait condition was acquired successfully. |

| Status code | Text description | Description |
|-------------|---------------------|--|
| 400 | Bad Request | The query character string is invalid. |
| 401 | Unauthorized | Authentication is required. |
| 403 | Forbidden | The operator does not have execution permission. |
| 404 | Not found | The operator does not have access permission for the resource, or the resource does not exist. |
| 409 | Conflict | The processing cannot be continued because the request is inconsistent with the current resource status. |
| 412 | Precondition failed | The Web Console server is not available. |
| 500 | Server-side error | A processing error occurred in the Web Console server. |

Response format

Message Body

```
Wait resource
```

Return values

If the status code is 200, the wait resource is returned. For details about wait resource, see [7.2.2 Wait resource](#).

Example

The following shows an example of using the API to acquire a list of the statuses of wait conditions for the specified unit.

Example request:

```
GET /ajs/api/v1/objects/waiting/%2FJobGroup%2FJobnet01:%40A102?manager=
HOSTM&serviceName=AJSROOT1 HTTP/1.1
Host: HOSTW:22252
Accept-Language: ja
X-AJS-Authorization: dXNlcjpwYXNzd29yZA==
```

Example response (message body):

```
{
  "status": "NORMAL",
  "startDelayStatus": "NO",
  "nestStartDelayStatus": "NO",
  "endDelayStatus": "NO",
  "nestEndDelayStatus": "NO",
  "execSchedule": "NONE",
  "waitMethod": "AND",
  "noGenerationAction": "NOT_EXECUTE",
  "unmonitoredEndedAction": "NOT_EXECUTE",
  "abnormalEndedAction": "NOT_EXECUTE",
  "waitingTargetUnits":
  [
    {
      "status": "NORMAL",
      "startDelayStatus": "NO",
      "nestStartDelayStatus": "NO",
      "endDelayStatus": "NO",
      "nestEndDelayStatus": "NO",
      "execSchedule": "NONE",
      "unitName": "/JobGroup/Jobnet02",
```

```

        "execID": "@A103",
        "holdPlan": "NONE",
        "unitComment": "",
        "waitingStatus": "COMPLETE"
    }
],
"unitName": "/JobGroup/Jobnet01",
"execID": "@A102",
"holdPlan": "NONE",
"unitComment": ""
}

```

7.1.5 Planned execution registration API

This API performs planned execution registration of the specified jobnets.

For details about planned execution registration, see *4.1.1(2) Planned execution* in the manual *JP1/Automatic Job Management System 3 Overview*.

Execution privileges

The login JP1 user must have one of the following JP1 permissions for the unit for which planned execution registration is performed:

- JP1_AJS_Admin privileges
- JP1_AJS_Manager privileges
- JP1_AJS_Operator privileges

Request format

Request line

```
POST /application/component/apiVersion/objects/definitions/unitName/actions/registerPlannedExec/invoke httpVersion
```

Message Body

```

{
  "parameters": {
    "manager": "manager-host-name-or-IP-address",
    "serviceName": "scheduler-service-name",
    "passedDaemonStarts": "behavior-when-the-planned-time-has-passed-at-the-startup-of-the-scheduler-service",
    "passedRegForExe": "behavior-when-the-planned-time-has-passed-at-execution-registration",
    "holding": "whether-to-hold-execution-of-the-jobnet",
    "macro": [macro-variable-object, ...]
  }
}

```

API version

v1

Information that uniquely identifies a resource

The table below describes the information that uniquely identifies a resource.

If a parameter is not specified or is specified incorrectly, an error with the status code 404 occurs because the resource cannot be uniquely identified.

| Information that uniquely identifies a resource | Data type | Description | Required? |
|---|-----------|--|-----------|
| <i>unitName</i> | String | Specify the full name of the unit to be requested, by using a character string in the range from 1 to 930 bytes. | Y |

Legend:

Y: Required

Parameter

The following table lists and describes the parameters that can be specified for `parameters` in the request message body.

Table 7–5: List of parameters for the planned execution registration API

| Parameter | Data type | Description of the value | Required? |
|---------------------------------|-----------|---|-----------|
| <code>manager</code> | String | Specify the manager host name or IP address by using a character string in the range from 1 to 255 bytes. | Y |
| <code>serviceName</code> | String | Specify the scheduler service name by using a character string in the range from 1 to 30 bytes. | Y |
| <code>passedDaemonStarts</code> | string | Specify the behavior when the planned time has passed at the startup of the scheduler service, by using a character string constant specified for the <code>PlannedTimePassedType</code> constant. For details about the <code>PlannedTimePassedType</code> constant, see 7.4.3(1) PlannedTimePassedType . The setting of this parameter is valid only when the startup mode of the scheduler service is warm start or disaster recovery start. | Y |
| <code>passedRegForExe</code> | String | Specify the behavior when the planned time has passed at execution registration, by using a character string constant specified for the <code>PlannedTimePassedType</code> constant. For details about the <code>PlannedTimePassedType</code> constant, see 7.4.3(1) PlannedTimePassedType . | Y |
| <code>holding</code> | Boolean | Specify whether to hold execution of the jobnet when planned execution registration is performed. If you want to hold execution, specify <code>true</code> . If you do not want to hold execution, specify <code>false</code> . If you specify <code>true</code> , hold is set for execution generations that are created when execution registration is performed. If you do not specify this parameter, <code>false</code> is assumed. You can specify this parameter only when the JP1/AJS3 - Web Console version is 11-10 or later and the version of connection-destination JP1/AJS3 - Manager is 11-10 or later. Before specifying this parameter, make sure that the return value of the version information acquisition API (<code>productVersionNumber</code>) is 111000 or greater. Also, make sure that the return value of the API (<code>protocolVersionNumber</code>) that acquires the protocol version of JP1/AJS3 - Manager is 1110 or greater. For details about the version information acquisition API, see 7.1.37 Version information acquisition API . For details about the JP1/AJS3 - Manager protocol version acquisition API, see 7.1.38 JP1/AJS3 - Manager protocol version acquisition API . | -- |

| Parameter | Data type | Description of the value | Required? |
|-----------|-----------|---|-----------|
| macro | object[] | <p>Specify the information to be set for the macro variables used by the jobs under the root jobnet, in the format of an array of the objects of the macro variables.</p> <p>For details about the macro variable object, see 7.3.5 Macro variable object.</p> <p>You can specify a maximum of 32 macro variables. If you specify multiple macro variables, ensure that the value of <i>number-of-bytes-for-the-macro-variable-names</i> + <i>number-of-bytes-for-the-passing-information</i> + 4 becomes 4,085 or less. If you specify the same macro variable multiple times, the passing information of the macro variable that is specified for the first time is passed.</p> <p>Specify this parameter only if you want to pass the macro variables. If you do not want to pass the macro variables, specify <code>null</code> for this parameter, or do not specify this parameter.</p> | -- |

Legend:

Y: Required

--: Optional

Status code

The following table lists and describes the status codes returned as a response:

| Status code | Text description | Description |
|-------------|---------------------|--|
| 200 | OK | Planned execution registration was successful. |
| 400 | Bad Request | The argument is invalid. |
| 401 | Unauthorized | Authentication is required. |
| 403 | Forbidden | The operator does not have execution permission. |
| 404 | Not found | The operator does not have access permission for the resource, or the resource does not exist. |
| 409 | Conflict | The processing cannot be continued because the request is inconsistent with the current resource status. |
| 412 | Precondition failed | The Web Console server is not available. |
| 500 | Server-side error | A processing error occurred in the Web Console server. |

Return values

None (The size of the response message body is 0 bytes.)

Example 1

The following shows an example of using the API that registers the specified jobnets for planned execution.

Example request:

```
POST /ajs/api/v1/objects/definitions/%2FJobGroup%2FJobnet/actions/registerPlannedExec/invoke HTTP/1.1
Host: HOSTW:22252
Accept-Language: ja
Content-type: application/json
X-AJS-Authorization: dXNlcjpwYXNzd29yZA==

{
  "parameters": {
    "manager": "HOSTM",
    "serviceName": "AJSROOT1",
```

```
    "passedDaemonStarts": "IMMEDIATE",
    "passedRegForExe": "IMMEDIATE"
  }
}
```

Example 2

The following shows an example of using the API that registers jobnets for planned execution by specifying macro variables.

Example request:

```
POST /ajs/api/v1/objects/definitions/%2FJobGroup%2FJobnet/actions/registerPlannedExec/invoke HTTP/1.1
Host: HOSTW:22252
Accept-Language: ja
Content-type: application/json
X-AJS-Authorization: dXNlcjpwYXNzd29yZA==

{
  "parameters": {
    "manager": "HOSTM",
    "serviceName": "AJSROOT1",
    "passedDaemonStarts": "IMMEDIATE",
    "passedRegForExe": "IMMEDIATE",
    "macro": [{"name": "AJS2KEY1", "value": "1"}, {"name": "AJS2KEY2", "value": "2"}]
  }
}
```

Example 3

The following shows an example of using the API that holds starting the first execution of a jobnet during registration for planned execution.

Example request:

```
POST /ajs/api/v1/objects/definitions/%2FJobGroup%2FJobnet/actions/registerPlannedExec/invoke HTTP/1.1
Host: HOSTW:22252
Accept-Language: ja
Content-type: application/json
X-AJS-Authorization: dXNlcjpwYXNzd29yZA==

{
  "parameters": {
    "manager": "HOSTM",
    "serviceName": "AJSROOT1",
    "passedDaemonStarts": "IMMEDIATE",
    "passedRegForExe": "IMMEDIATE",
    "holding": true
  }
}
```

7.1.6 Fixed execution registration API

This API performs fixed execution registration for the specified jobnet.

For details about fixed execution registration, see 4.1.1(3) *Fixed execution* in the manual *JP1/Automatic Job Management System 3 Overview*.

For additional information about fixed execution by specifying a specific date and time, see 4.5.2 *Adding an execution schedule to a jobnet* in the manual *JP1/Automatic Job Management System 3 Overview*.

Execution privileges

The login JP1 user must have one of the following JP1 permissions for the unit for which fixed execution registration is performed:

- JP1_AJS_Admin privileges
- JP1_AJS_Manager privileges
- JP1_AJS_Operator privileges

Request format

Request line

```
POST /application/component/apiVersion/objects/definitions/unitName/actions/registerFixedExec/invoke httpVersion
```

Message Body

```
{
  "parameters":{
    "manager":"manager-host-name-or-IP-address",
    "serviceName":"scheduler-service-name",
    "fixedScheduleFrom":"start-date-of-the-fixed-schedule-period",
    "fixedScheduleTo":"end-date-of-the-fixed-schedule-period",
    "futureGeneration":future-generation,
    "startTime":"date-and-time-to-start-jobnet-execution",
    "passedDaemonStarts":"behavior-when-the-planned-time-has-passed-at-the-startup-of-the-scheduler-service",
    "holding":whether-to-hold-execution-of-the-jobnet,
    "macro":[macro-variable-object,...]
  }
}
```

API version

v1

Information that uniquely identifies a resource

The table below describes the information that uniquely identifies a resource.

If a parameter is not specified or is specified incorrectly, an error with the status code 404 occurs because the resource cannot be uniquely identified.

| Information that uniquely identifies a resource | Data type | Description | Required? |
|---|-----------|--|-----------|
| <i>unitName</i> | String | Specify the full name of the unit to be requested, by using a character string in the range from 1 to 930 bytes. | Y |

Legend:

Y: Required

Parameter

The following table lists and describes the parameters that can be specified for `parameters` in the request message body.

Table 7–6: List of parameters for the fixed execution registration API

| Parameter | Data type | Description of the value | Required? |
|---------------------------------|-----------|---|-----------|
| manager | String | Specify the manager host name or IP address by using a character string in the range from 1 to 255 bytes. | Y |
| serviceName | String | Specify the scheduler service name by using a character string in the range from 1 to 30 bytes. | Y |
| fixedScheduleFrom ^{#1} | string | <p>Specify this parameter to perform fixed execution registration by specifying a fixed period.</p> <p>Specify the start date of the fixed schedule period in which a fixed execution schedule is executed, in the <i>YYYY-MM-DD</i> format. You can specify the following values:</p> <ul style="list-style-type: none"> • <i>YYYY</i>: specify the year. The following are the possible values for the year: If the version of JP1/AJS3 - Web Console is 13-00 or later and the version of the connection-destination JP1/AJS3 - Manager is 13-00 or later: 1994 to the value specified for the <code>SCHEDULELIMIT</code> environment setting parameter (unit: year)^{#2} In cases other than the above: 1994 to 2036 (unit: year) • <i>MM</i>: Specify the month. You can specify the month in the range from 01 to 12 (unit: month). • <i>DD</i>: Specify the day. You can specify the day in the range from 01 to the last day of the specified month (unit: day). <p>Specify the date by using the local date for the scheduler service of the request-destination JP1/AJS3 - Manager.</p> <p>If you specify the start date of the fixed schedule period, ensure that you specify the end date of the fixed schedule period. If you do not specify the end date, an error occurs.</p> <p>If you do not want to specify the fixed schedule period, specify <code>null</code> for this parameter, or do not specify this parameter.</p> | -- |
| fixedScheduleTo ^{#1} | String | <p>Specify this parameter to perform fixed execution registration by specifying a fixed period.</p> <p>Specify the end date of the fixed schedule period in which a fixed execution schedule is executed, in the <i>YYYY-MM-DD</i> format. You can specify the following values:</p> <ul style="list-style-type: none"> • <i>YYYY</i>: specify the year. The following are the possible values for the year: If the version of JP1/AJS3 - Web Console is 13-00 or later and the version of the connection-destination JP1/AJS3 - Manager is 13-00 or later: 1994 to the value specified for the <code>SCHEDULELIMIT</code> environment setting parameter (unit: year)^{#2} In cases other than the above: 1994 to 2036 (unit: year) • <i>MM</i>: Specify the month. You can specify the month in the range from 01 to 12 (unit: month). • <i>DD</i>: Specify the day. You can specify the day in the range from 01 to the last day of the specified month (unit: day). | -- |

| Parameter | Data type | Description of the value | Required? |
|---|-----------|--|-----------|
| <code>fixedScheduleTo</code> ^{#1} | String | Specify the date by using the local date for the scheduler service of the request-destination JP1/AJS3 - Manager. If you specify the start date of the fixed schedule period, ensure that you specify the end date of the fixed schedule period. If you do not specify the end date, an error occurs. If you do not want to specify the fixed schedule period, specify <code>null</code> for this parameter, or do not specify this parameter. | -- |
| <code>futureGeneration</code> ^{#1} | int | Specify this parameter to perform fixed execution registration by specifying the number of future generations. Specify the number of times an execution schedule will be created. You can specify a value in the range from 1 to 99 (unit: generation). If you do not specify the future generation, do not specify this parameter, or specify 0 for this parameter. | -- |
| <code>startTime</code> ^{#1} | String | Specify this parameter to add an execution schedule by specifying the date and time regardless of the schedule definition for the jobnet. Specify the date and time to start execution of the jobnet in <code>YYYY-MM-DDThh:mm</code> format. You can specify the following values: <ul style="list-style-type: none"> YYYY: specify the year. The following are the possible values for the year: If the version of JP1/AJS3 - Web Console is 13-00 or later and the version of the connection-destination JP1/AJS3 - Manager is 13-00 or later: 1994 to the value specified for the <code>SCHEDULELIMIT</code> environment setting parameter (unit: year)^{#2} In cases other than the above: 1994 to 2036 (unit: year) MM: Specify the month. You can specify the month in the range from 01 to 12 (unit: month). DD: Specify the day. You can specify the day in the range from 01 to the last day of the specified month (unit: day). hh: Specify the hour. You can specify the hour in the range from 00 to 47 (unit: hour). mm: Specify the minute. You can specify the minute in the range from 00 to 59 (unit: minute). Specify the date by using the local date for the scheduler service of the request-destination JP1/AJS3 - Manager. You can specify this parameter only when the JP1/AJS3 - Web Console version is 11-10 or later. Before specifying this parameter, make sure that the return value of the version information acquisition API (<code>productVersionNumber</code>) is 111000 or greater. For details about the version information acquisition API, see 7.1.37 Version information acquisition API . | -- |
| <code>passedDaemonStarts</code> | string | Specify the behavior when the planned time has passed at the startup of the scheduler service, by using a character string constant specified for the <code>PlannedTimePassedType</code> | -- |

| Parameter | Data type | Description of the value | Required? |
|--------------------|-----------|--|-----------|
| passedDaemonStarts | string | <p>constant. For details about the <code>PlannedTimePassedType</code> constant, see 7.4.3(1) PlannedTimePassedType.</p> <p>The setting of this parameter is valid only when the startup mode of the scheduler service is warm start or disaster recovery start.</p> <p>For this parameter, the operation performed when the fixed period or the number of future generations is specified differs from the operation performed when the date and time are specified.</p> <p>The operation performed is as follows:</p> <ul style="list-style-type: none"> • If the fixed period and the number of future generations are specified without specifying this parameter, an error occurs. • If the date and time are specified without specifying this parameter or with <code>null</code> specified for this parameter, <code>IMMEDIATE</code> (execute immediately) is assumed. You can specify this parameter only when the JP1/AJS3 - Web Console version is 11-10 or later and the version of connection-destination JP1/AJS3 - Manager is 11-10 or later. Before specifying this parameter, make sure that the return value of the version information acquisition API (<code>productVersionNumber</code>) is 111000 or greater. Also, make sure that the return value of the API (<code>protocolVersionNumber</code>) that acquires the protocol version of JP1/AJS3 - Manager is 1110 or greater. <p>For details about the version information acquisition API, see 7.1.37 Version information acquisition API.</p> <p>For details about the JP1/AJS3 - Manager protocol version acquisition API, see 7.1.38 JP1/AJS3 - Manager protocol version acquisition API.</p> | -- |
| holding | boolean | <p>Specify whether to hold execution of the jobnet when fixed execution registration is performed. If you want to hold execution, specify <code>true</code>. If you do not want to hold execution, specify <code>false</code>.</p> <p>If you specify <code>true</code>, <code>hold</code> is set for the first execution generation of generations that are created when execution registration is performed.</p> <p>If you do not specify this parameter, <code>false</code> is assumed.</p> <p>You can specify this parameter only when the JP1/AJS3 - Web Console version is 11-10 or later and the version of connection-destination JP1/AJS3 - Manager is 11-10 or later. Before specifying this parameter, make sure that the return value of the version information acquisition API (<code>productVersionNumber</code>) is 111000 or greater. Also, make sure that the return value of the API (<code>protocolVersionNumber</code>) that acquires the protocol version of JP1/AJS3 - Manager is 1110 or greater.</p> <p>For details about the version information acquisition API, see 7.1.37 Version information acquisition API.</p> <p>For details about the JP1/AJS3 - Manager protocol version acquisition API, see 7.1.38 JP1/AJS3 - Manager protocol version acquisition API.</p> | -- |
| macro | object[] | <p>Specify the information to be set for the macro variables used by the jobs under the root jobnet, in the format of an array of the objects of the macro variables.</p> <p>For details about the macro variable object, see 7.3.5 Macro variable object.</p> <p>You can specify a maximum of 32 macro variables. If you specify multiple macro variables, ensure that the value of <i>number-of-</i></p> | -- |

| Parameter | Data type | Description of the value | Required? |
|-----------|-----------|--|-----------|
| macro | object[] | <i>bytes-for-the-macro-variable-names + number-of-bytes-for-the-passing-information + 4</i> becomes 4,085 or less. If you specify the same macro variable multiple times, the passing information of the macro variable that is specified for the first time is passed. If you do not want to pass macro variables, do not specify this parameter, or specify <code>null</code> for this parameter. | -- |

Legend:

Y: Required

--: Optional

#1

You must specify the fixed period (`fixedScheduleFrom` and `fixedScheduleTo`), the number of future generations (`futureGeneration`), or addition of an execution schedule by specifying the date and time (`startTime`). If you do not specify a monitoring procedure (or if `null` is specified), an error occurs.

You can specify the fixed period together with the number of future generations. However, addition of an execution schedule by specifying the date and time cannot be specified with the fixed period or the number of future generations. If they are specified together, an error occurs.

#2

For details about the `SCHEDULELIMIT` environment setting parameter of the connection-destination JP1/AJS3 - Manager, see *20.4.2(123) SCHEDULELIMIT* in the *JP1/Automatic Job Management System 3 Configuration Guide*.

You can check the version of JP1/AJS3 - Web Console from the return value (`productVersionNumber`) of the version information acquisition API function. You can check the version of the connection-destination JP1/AJS3 - Manager from the return value (`protocolVersionNumber`) of the JP1/AJS3 - Manager protocol version acquisition API function.

For details about the version information acquisition API, see *7.1.37 Version information acquisition API*.

For details about the JP1/AJS3 - Manager protocol version acquisition API, see *7.1.38 JP1/AJS3 - Manager protocol version acquisition API*.

Status code

The following table lists and describes the status codes returned as a response:

| Status code | Text description | Description |
|-------------|---------------------|--|
| 200 | OK | Fixed execution registration was successful. |
| 400 | Bad Request | An argument is invalid. |
| 401 | Unauthorized | Authentication is required. |
| 403 | Forbidden | The operator does not have execution permission. |
| 404 | Not found | The operator does not have access permission for the resource, or the resource does not exist. |
| 409 | Conflict | The processing cannot be continued because the request is inconsistent with the current resource status. |
| 412 | Precondition failed | The Web Console server is not available. |
| 500 | Server-side error | A processing error occurred in the Web Console server. |

Response format

Response message body when the fixed period and the number of future generations are specified

None (The size of the response message body is 0 bytes.)

Response message body when the date and time are specified

```
{
  "execID": "execution-ID"
}
```

Return values

If the fixed period and the number of future generations are specified:

None (The size of the response message body is 0 bytes.)

If the date and time are specified:

If the status code is 200, the following information is returned:

| Member | Data type | Description |
|--------|-----------|---|
| execID | String | Returns the execution ID in the format of @[mmmm]{A to Z}nnnn (for example, @10A200). |

Example 1

The following shows an example of using the API that performs fixed execution registration by specifying the period.

Example request:

```
POST /ajs/api/v1/objects/definitions/%2FJobGroup%2FJobnet/actions/registerFixedExec/invoke HTTP/1.1
Host: HOSTW:22252
Accept-Language: ja
Content-type: application/json
X-AJS-Authorization: dXNlcjpwYXNzd29yZA==

{
  "parameters":{
    "manager":"HOSTM",
    "serviceName":"AJSROOT1",
    "fixedScheduleFrom":"2015-09-07",
    "fixedScheduleTo":"2015-09-11",
    "passedDaemonStarts":"IMMEDIATE"
  }
}
```

Example 2

The following shows an example of using the API that performs fixed execution registration by specifying the future generation number and macro variables.

Example request:

```
POST /ajs/api/v1/objects/definitions/%2FJobGroup%2FJobnet/actions/registerFixedExec/invoke HTTP/1.1
Host: HOSTW:22252
Accept-Language: ja
Content-type: application/json
X-AJS-Authorization: dXNlcjpwYXNzd29yZA==

{
  "parameters":{
    "manager":"HOSTM",
    "serviceName":"AJSROOT1",
    "futureGeneration":5,
    "passedDaemonStarts":"IMMEDIATE",
  }
}
```

```
    "macro": [{"name": "AJS2KEY1", "value": "1"}, {"name": "AJS2KEY2", "value": "2"}]
  }
}
```

Example 3

The following shows an example of using the API that adds an execution schedule by specifying the date and time regardless of the schedule definition for the jobnet.

Example request:

```
POST /ajs/api/v1/objects/definitions/%2FJobGroup%2FJobnet/actions/registerFixedExec/invoke HTTP/1.1
Host: HOSTW:22252
Accept-Language: ja
Content-type: application/json
X-AJS-Authorization: dXNlcjpwYXNzd29yZA==

{
  "parameters": {
    "manager": "HOSTM",
    "serviceName": "AJSROOT1",
    "startTime": "2016-09-07T08:30",
    "passedDaemonStarts": "IMMEDIATE"
  }
}
```

Example response (message body):

```
{
  "execID": "@A100"
}
```

Example 4

The following shows an example of using the API that holds starting the first execution of a jobnet during registration for fixed execution.

Example request:

```
POST /ajs/api/v1/objects/definitions/%2FJobGroup%2FJobnet/actions/registerFixedExec/invoke HTTP/1.1
Host: HOSTW:22252
Accept-Language: ja
Content-type: application/json
X-AJS-Authorization: dXNlcjpwYXNzd29yZA==

{
  "parameters": {
    "manager": "HOSTM",
    "serviceName": "AJSROOT1",
    "fixedScheduleFrom": "2016-09-07",
    "fixedScheduleTo": "2016-09-11",
    "passedDaemonStarts": "IMMEDIATE",
    "holding": true
  }
}
```

7.1.7 Immediate execution registration API

This API performs immediate execution registration for the specified jobnet.

For details about immediate execution registration, see *4.1.1(1) Immediate execution* in the manual *JP1/Automatic Job Management System 3 Overview*.

Execution privileges

The login JP1 user must have one of the following JP1 permissions for the unit for which immediate execution registration is performed:

- JP1_AJS_Admin privileges
- JP1_AJS_Manager privileges
- JP1_AJS_Operator privileges

Request format

Request line

```
POST /application/component/apiVersion/objects/definitions/unitName/actions/registerImmediateExec/invoke httpVersion
```

Message Body

```
{
  "parameters":{
    "manager":"manager-host-name-or-IP-address",
    "serviceName":"scheduler-service-name",
    "startCondition":object-of-the-start-condition-parameter,
    "holding":whether-to-hold-execution-of-the-jobnet,
    "macro":[macro-variable-object,...]
  }
}
```

API version

v1

Information that uniquely identifies a resource

The table below describes the information that uniquely identifies a resource.

If a parameter is not specified or is specified incorrectly, an error with the status code 404 occurs because the resource cannot be uniquely identified.

| Information that uniquely identifies a resource | Data type | Description | Required? |
|---|-----------|--|-----------|
| <i>unitName</i> | String | Specify the full name of the unit to be requested, by using a character string in the range from 1 to 930 bytes. | Y |

Legend:

Y: Required

Parameter

The following table lists and describes the parameters that can be specified for `parameters` in the request message body.

Table 7–7: List of parameters for the immediate execution registration API

| Parameter | Data type | Description of the value | Required? |
|----------------|-----------|--|-----------|
| manager | String | Specify the manager host name or IP address by using a character string in the range from 1 to 255 bytes. | Y |
| serviceName | String | Specify the scheduler service name by using a character string in the range from 1 to 30 bytes. | Y |
| startCondition | Object | If you execute a jobnet by using the start condition, specify the start condition parameter object. For details about the start condition parameter object, see 7.3.4 Start condition parameter object . If you do not specify the start condition, do not specify this parameter, or specify <code>null</code> for this parameter. | -- |
| holding | Boolean | Specify whether to hold execution of the jobnet when immediate execution registration is performed. If you want to hold execution, specify <code>true</code> . If you do not want to hold execution, specify <code>false</code> . If you do not specify this parameter, <code>false</code> is assumed. | -- |
| macro | object[] | Specify the information to be set for the macro variables used by the jobs under the root jobnet, in the format of an array of the objects of the macro variables. For details about the macro variable object, see 7.3.5 Macro variable object . You can specify a maximum of 32 macro variables. If you specify multiple macro variables, ensure that the value of <i>number-of-bytes-for-the-macro-variable-names</i> + <i>number-of-bytes-for-the-passing-information</i> + 4 becomes 4,085 or less. If you specify the same macro variable multiple times, the passing information of the macro variable that is specified for the first time is passed. If you do not want to pass macro variables, do not specify this parameter, or specify <code>null</code> for this parameter. | -- |

Legend:

Y: Required

--: Optional

Status code

The following table lists and describes the status codes returned as a response:

| Status code | Text description | Description |
|-------------|---------------------|--|
| 200 | OK | Immediate execution registration was successful. |
| 400 | Bad Request | An argument is invalid. |
| 401 | Unauthorized | Authentication is required. |
| 403 | Forbidden | The operator does not have execution permission. |
| 404 | Not found | The operator does not have access permission for the resource, or the resource does not exist. |
| 409 | Conflict | The processing cannot be continued because the request is inconsistent with the current resource status. |
| 412 | Precondition failed | The Web Console server is not available. |
| 500 | Server-side error | A processing error occurred in the Web Console server. |

Response format

Response message body

```
{
  "execID": "execution-ID"
}
```

Return values

If the status code is 200, the following information is returned:

| Member | Data type | Description |
|--------|-----------|---|
| execID | String | Returns the execution ID in the format of @[mmmm]{A to Z}nnnn (for example, @10A200). If the start condition is specified, the execution ID of the monitoring generation is returned. |

Example 1

The following shows an example of using the API that registers the specified jobnet for immediate execution.

Example request:

```
POST /ajs/api/v1/objects/definitions/%2FJobGroup%2FJobnet/actions/registerImmediateExec/invoke HTTP/1.1
Host: HOSTW:22252
Accept-Language: ja
Content-type: application/json
X-AJS-Authorization: dXNlcjpwYXNzd29yZA==

{
  "parameters":{
    "manager":"HOSTM",
    "serviceName":"AJSROOT1"
  }
}
```

Example response (message body):

```
{
  "execID": "@A2895"
}
```

Example 2

The following shows an example of using the API that registers a jobnet for immediate execution by specifying the start condition parameter (count) and macro variables.

Example request:

```
POST /ajs/api/v1/objects/definitions/%2FJobGroup%2FJobnet/actions/registerImmediateExec/invoke HTTP/1.1
Host: HOSTW:22252
Accept-Language: ja
Content-type: application/json
X-AJS-Authorization: dXNlcjpwYXNzd29yZA==

{
  "parameters":{
    "manager":"HOSTM",
    "serviceName":"AJSROOT1",
    "startCondition":{
```

```
        "times":5
      },
      "macro":[{"name":"AJS2KEY1","value":"1"}, {"name":"AJS2KEY2","value"
:"2"}]
    }
  }
```

Example response (message body):

```
{
  "execID": "@A2897"
}
```

Example 3

The following shows an example of using the API that holds execution of a jobnet during registration for immediate execution.

Example request:

```
POST /ajs/api/v1/objects/definitions/%2FJobGroup%2FJobnet/actions/registerImmediateExec/invoke HTTP/1.1
Host: HOSTW:22252
Accept-Language: ja
Content-type: application/json
X-AJS-Authorization: dXNlcjpwYXNzd29yZA==

{
  "parameters":{
    "manager":"HOSTM",
    "serviceName":"AJSROOT1",
    "holding":true
  }
}
```

Example response (message body):

```
{
  "execID": "@A100"
}
```

7.1.8 Registration cancellation API

This API cancels registration of a specified jobnet for which execution registration has been performed.

For details about registration cancellation, see *4.5.1 Canceling registration of a jobnet* in the manual *JP1/Automatic Job Management System 3 Overview*.

Execution privileges

The login JP1 user must have one of the following JP1 permissions for the unit for which fixed execution registration is performed:

- JP1_AJS_Admin privileges
- JP1_AJS_Manager privileges
- JP1_AJS_Operator privileges

Request format

Request line

```
POST /application/component/apiVersion/objects/definitions/unitName/actions/cancelRegistration/invoke httpVersion
```

Message body

```
{
  "parameters":{
    "manager":"manager-host-name-or-IP-address",
    "serviceName":"scheduler-service-name",
    "dateType":"calendar-date-or-execution-date"
    "begin":"start-date-of-the-period-for-which-registration-is-to-be-canceled"
    "end":"end-date-of-the-period-for-which-registration-is-to-be-canceled"
  }
}
```

API version

v1

Information that uniquely identifies a resource

The table below describes the information that uniquely identifies a resource.

If a parameter is not specified or is specified incorrectly, an error with the status code 404 occurs because the resource cannot be uniquely identified.

| Information that uniquely identifies a resource | Data type | Description | Required? |
|---|-----------|--|-----------|
| <i>unitName</i> | String | Specify the full name of the unit to be requested, by using a character string in the range from 1 to 930 bytes. | Y |

Legend:

Y: Required

Parameter

The following table lists and describes the parameters that can be specified for `parameters` in the request message body.

Table 7–8: List of parameters for the registration cancellation API

| Parameter | Data type | Description of the value | Required? |
|-------------------------------------|-----------|--|-----------|
| <code>manager</code> | String | Specify the manager host name or IP address by using a character string in the range from 1 to 255 bytes. | Y |
| <code>serviceName</code> | String | Specify the scheduler service name by using a character string in the range from 1 to 30 bytes. | Y |
| <code>dateType</code> ^{#1} | String | Specify the period for which execution registration is to be canceled, by using a calendar date or execution date, or by using a character string constant specified for the <code>DateType</code> constant. For details about the <code>DateType</code> constant, see 7.4.1(1) DateType . If you do not want to specify the period for which execution registration is to be canceled, specify <code>null</code> for this parameter, or do not specify this parameter. | -- |

| Parameter | Data type | Description of the value | Required? |
|----------------------------------|-----------|---|-----------|
| <code>begin</code> ^{#1} | String | <p>Specify the start date of the period for which execution registration is to be canceled, in the <i>YYYY-MM-DD</i> format. You can specify the following values:</p> <ul style="list-style-type: none"> <i>YYYY</i>: specify the year. The following are the possible values for the year: If the version of JP1/AJS3 - Web Console is 13-00 or later and the version of the connection-destination JP1/AJS3 - Manager is 13-00 or later: 1994 to the value specified for the <code>SCHEDULELIMIT</code> environment setting parameter (unit: year)^{#2} In cases other than the above: 1994 to 2036 (unit: year) <i>MM</i>: Specify the month. You can specify the month in the range from 01 to 12 (unit: month). <i>DD</i>: Specify the day. You can specify the day in the range from 01 to the last day of the specified month (unit: day). <p>Specify the date by using the local date for the scheduler service of the request-destination JP1/AJS3 - Manager.</p> <p>If you do not want to specify the period for which execution registration is to be canceled, specify <code>null</code> for this parameter, or do not specify this parameter.</p> | -- |
| <code>end</code> ^{#1} | string | <p>Specify the end date of the period for which execution registration is to be canceled, in the <i>YYYY-MM-DD</i> format. You can specify the following values:</p> <ul style="list-style-type: none"> <i>YYYY</i>: specify the year. The following are the possible values for the year: If the version of JP1/AJS3 - Web Console is 13-00 or later and the version of the connection-destination JP1/AJS3 - Manager is 13-00 or later: 1994 to the value specified for the <code>SCHEDULELIMIT</code> environment setting parameter (unit: year)^{#2} In cases other than the above: 1994 to 2036 (unit: year) <i>MM</i>: Specify the month. You can specify the month in the range from 01 to 12 (unit: month). <i>DD</i>: Specify the day. You can specify the day in the range from 01 to the last day of the specified month (unit: day). <p>Specify the date by using the local date for the scheduler service of the request-destination JP1/AJS3 - Manager.</p> <p>Note that you must specify, for this parameter, a value that is equal to or later than the date specified for the <code>begin</code> parameter. If you specify a value that is earlier than the date specified for the <code>begin</code> parameter, an error occurs.</p> <p>If you do not want to specify the period for which execution registration is to be canceled, specify <code>null</code> for this parameter, or do not specify this parameter.</p> | -- |

Legend:

Y: Required

--: Optional

#1

If you omit all the `dateType`, `begin`, and `end` parameters, execution registration of all specified jobnets is canceled.

If you cancel execution registration by specifying the period, specify all the `dateType`, `begin`, and `end` parameters. If you omit any of the parameters, an error occurs.

#2

For details about the `SCHEDULELIMIT` environment setting parameter of the connection-destination JP1/AJS3 - Manager, see [20.4.2\(123\) SCHEDULELIMIT](#) in the *JP1/Automatic Job Management System 3 Configuration Guide*.

You can check the version of JP1/AJS3 - Web Console from the return value (`productVersionNumber`) of the version information acquisition API function. You can check the version of the connection-destination JP1/AJS3 - Manager from the return value (`protocolVersionNumber`) of the JP1/AJS3 - Manager protocol version acquisition API function.

For details about the version information acquisition API, see [7.1.37 Version information acquisition API](#).

For details about the JP1/AJS3 - Manager protocol version acquisition API, see [7.1.38 JP1/AJS3 - Manager protocol version acquisition API](#).

Status code

The following table lists and describes the status codes returned as a response:

| Status code | Text description | Description |
|-------------|---------------------|--|
| 200 | OK | Canceling registration was successful. |
| 400 | Bad Request | An argument is invalid. |
| 401 | Unauthorized | Authentication is required. |
| 403 | Forbidden | The operator does not have execution permission. |
| 404 | Not found | The operator does not have access permission for the resource, or the resource does not exist. |
| 409 | Conflict | The processing cannot be continued because the request is inconsistent with the current resource status. |
| 412 | Precondition failed | The Web Console server is not available. |
| 500 | Server-side error | A processing error occurred in the Web Console server. |

Return values

None (The size of the response message body is 0 bytes.)

Example 1

The following shows an example of using the API that cancels registration of the specified jobnet registered for execution.

Example request:

```
POST /ajs/api/v1/objects/definitions/%2FJobGroup%2FJobnet/actions/cancelRegistration/invoke HTTP/1.1
Host: HOSTW:22252
Accept-Language: ja
Content-type: application/json
X-AJS-Authorization: dXNlcjpwYXNzd29yZA==

{
  "parameters": {
    "manager": "HOSTM",
```

```
    "serviceName": "AJSROOT1"
  }
}
```

Example 2

The following shows an example of using the API that cancels execution registration of the jobnet by specifying the period.

Example request:

```
POST /ajs/api/v1/objects/definitions/%2FJobGroup%2FJobnet/actions/cancelRegistration/invoke HTTP/1.1
Host: HOSTW:22252
Accept-Language: ja
Content-type: application/json
X-AJS-Authorization: dXNlcjpwYXNzd29yZA==

{
  "parameters": {
    "manager": "HOSTM",
    "serviceName": "AJSROOT1",
    "dateType": "CALENDAR_DATE",
    "begin": "2015-09-09",
    "end": "2015-09-11"
  }
}
```

7.1.9 Change hold attribute API

This API changes the hold attribute of the specified unit.

For details about changing the hold attribute, see *4.5.6 Temporarily changing the hold attribute of a job or jobnet* in the manual *JP1/Automatic Job Management System 3 Overview*.

Execution privileges

The logged in user must have one of the following JP1 permissions for the unit whose hold attribute is to be changed:

- JP1_AJS_Admin privileges
- JP1_AJS_Manager privileges
- JP1_AJS_Operator privileges

Request format

Request line

```
POST /application/component/apiVersion/objects/statuses/unitName:execID
/actions/changeHold/invoke httpVersion
```

Message Body

```
{
  "parameters": {
    "manager": "manager-host-name-or-IP-address",
    "serviceName": "scheduler-service-name",
    "holdAttr": "hold-attribute-is-set-or-released"
  }
}
```

```

    }
}

```

API version

v1

Information that uniquely identifies a resource

The table below describes the information that uniquely identifies a resource.

If a parameter is not specified or is specified incorrectly, an error with the status code 404 occurs because the resource cannot be uniquely identified.

| Information that uniquely identifies a resource | Data type | Description | Required? |
|---|-----------|--|-----------|
| <i>unitName</i> | string | Specify the full name of the unit to be requested, by using a character string in the range from 1 to 930 bytes. | Y |
| <i>execID</i> | String | Specify the execution ID by using a character string in the format of @[<i>mmmm</i>] { <i>A to Z</i> } <i>nnnn</i> (for example, @10A200). | Y |

Legend:

Y: Required

Parameter

The following table lists and describes the parameters that can be specified for `parameters` in the request message body.

Table 7–9: List of parameters for the change hold attribute API

| Parameter | Data type | Description of the value | Required? |
|--------------------------|-----------|---|-----------|
| <code>manager</code> | String | Specify the manager host name or IP address by using a character string in the range from 1 to 255 bytes. | Y |
| <code>serviceName</code> | String | Specify the scheduler service name by using a character string in the range from 1 to 30 bytes. | Y |
| <code>holdAttr</code> | String | Specify whether to set or release the hold attribute, by using a character string constant specified for the <code>ChangeHoldAttr</code> constant. For details about the <code>ChangeHoldAttr</code> constant, see 7.4.8(1) ChangeHoldAttr . | Y |

Legend:

Y: Required

Status code

The following table lists and describes the status codes returned as a response:

| Status code | Text description | Description |
|-------------|------------------|--|
| 200 | OK | The hold attribute was successfully changed. |
| 400 | Bad Request | The argument is invalid. |
| 401 | Unauthorized | Authentication is required. |
| 403 | Forbidden | The operator does not have execution permission. |
| 404 | Not found | The operator does not have access permission for the resource, or the resource does not exist. |

| Status code | Text description | Description |
|-------------|---------------------|--|
| 409 | Conflict | The processing cannot be continued because the request is inconsistent with the current resource status. |
| 412 | Precondition failed | The Web Console server is not available. |
| 500 | Server-side error | A processing error occurred in the Web Console server. |

Return values

None (The size of the response message body is 0 bytes.)

Example 1

The following shows an example of using the API that sets the hold attribute for the specified jobnet.

Example request:

```
POST /ajs/api/v1/objects/statuses/%2FJobGroup%2FJobnet:%40A100/actions/
changeHold/invoke HTTP/1.1
Host: HOSTW:22252
Accept-Language: ja
Content-type: application/json
X-AJS-Authorization: dXNlcjpwYXNzd29yZA==

{
  "parameters":{
    "manager":"HOSTM",
    "serviceName":"AJSROOT1",
    "holdAttr":"SET"
  }
}
```

Example 2

The following shows an example of using the API that releases the hold on the specified jobnet.

Example request:

```
POST /ajs/api/v1/objects/statuses/%2FJobGroup%2FJobnet:%40A100/actions/
changeHold/invoke HTTP/1.1
Host: HOSTW:22252
Accept-Language: ja
Content-type: application/json
X-AJS-Authorization: dXNlcjpwYXNzd29yZA==

{
  "parameters":{
    "manager":"HOSTM",
    "serviceName":"AJSROOT1",
    "holdAttr":"RELEASE"
  }
}
```

7.1.10 Change delay monitor API

This API temporarily changes the delay monitor settings for the specified jobnet registered for execution.

For details about temporary change of the delay monitor settings, see *4.5.7 Temporarily changing the delay monitor settings of a jobnet* in the manual *JP1/Automatic Job Management System 3 Overview*.

You can use this API only when the JP1/AJS3 - Web Console version is 11-10 or later. Before using this API, make sure that the return value of the version information acquisition API (`productVersionNumber`) is 111000 or greater.

Execution privileges

The logged in JP1 user must have one of the following JP1 permissions for the unit for which the delay monitor settings are to be changed:

- JP1_AJS_Admin privileges
- JP1_AJS_Manager privileges
- JP1_AJS_Operator privileges

Request format

Request line

```
POST /application/component/apiVersion/objects/statuses/unitName:execID
/actions/changeDelayMonitor/invoke httpVersion
```

Message Body

```
{
  "parameters":{
    "manager":"manager-host-name-or-IP-address",
    "serviceName":"scheduler-service-name",
    "delayedStart":"start-delay-monitoring-method",
    "delayedStartTime":"time-to-start-monitoring-of-start-delay",
    "delayedEnd":"end-delay-monitoring-method",
    "delayedEndTime":"time-to-start-monitoring-of-end-delay",
    "monitoringJobnet":"end-delay-monitoring-method-using-the-time-req-
ired-to-execute-jobnet",
    "timeRequiredForExecution":"time-required-to-execute-jobnet"
  }
}
```

API version

v1

Information that uniquely identifies a resource

The table below describes the information that uniquely identifies a resource.

If a parameter is not specified or is specified incorrectly, an error with the status code 404 occurs because the resource cannot be uniquely identified.

| Information that uniquely identifies a resource | Data type | Description | Required? |
|---|-----------|--|-----------|
| <i>unitName</i> | String | Specify the full name of the unit to be requested, by using a character string in the range from 1 to 930 bytes. | Y |
| <i>execID</i> | string | Specify the execution ID by using a character string in the format of @[<i>mmm</i>] { <i>A</i> to <i>Z</i> } <i>nnnn</i> (for example, @10A200). | Y |

Legend:

Y: Required

Parameter

The following table lists and describes the parameters that can be specified for `parameters` in the request message body.

Table 7–10: List of parameters for the change delay monitor API

| Parameter | Data type | Description of the value | Required? |
|-------------------------------|-----------|---|-----------|
| <code>manager</code> | String | Specify the manager host name or IP address by using a character string in the range from 1 to 255 bytes. | Y |
| <code>serviceName</code> | String | Specify the scheduler service name by using a character string in the range from 1 to 30 bytes. | Y |
| <code>delayedStart#</code> | String | <p>Specify the method of monitoring start delays, by using a character string constant specified for the <code>DelayMonitorType</code> constant. For details about the <code>DelayMonitorType</code> constant, see 7.4.11(1) DelayMonitorType.</p> <p>If you do not want to change the start delay monitor settings, do not specify this parameter, or specify <code>null</code> for this parameter.</p> <p>If you specify a constant that cannot be specified for the root jobnet, an error occurs.</p> <p>If the jobnet is running, you cannot change the start delay monitor settings. If you specify this parameter, an error occurs.</p> | -- |
| <code>delayedStartTime</code> | string | <p>Specify the start time of start delay monitoring, by using a character string.</p> <p>You must specify this parameter if you use the <code>delayedStart</code> parameter to change the start delay monitor settings. If you omit this parameter, an error occurs.</p> <p>If you specify <code>ABSOLUTE</code> (absolute time) for the <code>delayedStart</code> parameter, specify the start time of start delay monitoring, by using an absolute time in <code>hh:mm</code> format.</p> <p>Specify the time by using the local time for the scheduler service of the request-destination JP1/AJS3 - Manager.</p> <p>You can specify the following values:</p> <ul style="list-style-type: none"> • <code>hh</code>: Specify the hour. You can specify the hour in the range from 00 to 47 (unit: hour). • <code>mm</code>: Specify the minute. You can specify the minute in the range from 00 to 59 (unit: minute). <p>If you specify one of the following values for the <code>delayedStart</code> parameter, specify a relative time in <code>hh:mm</code> format: <code>ROOT</code> (relative time from the scheduled start time of the root jobnet), <code>TOP</code> (relative time from the scheduled start time of the upper jobnet), or <code>OWN</code> (relative time from the scheduled start time of the local jobnet).</p> <p>Specify the time by using the local time for the scheduler service of the request-destination JP1/AJS3 - Manager.</p> <p>You can specify the following values:</p> <ul style="list-style-type: none"> • <code>hh</code>: Specify the hour. You can specify the hour in the range from 00 to 47 (unit: hour). • <code>mm</code>: Specify the minute. You can specify the minute in the range from 00 to 59 (unit: minute). | -- |

| Parameter | Data type | Description of the value | Required? |
|-------------------------------|-----------|---|-----------|
| delayedStartTime | string | <p>However, you cannot specify 00:00. Specify a value in the range from 00:01 to 47:59.</p> <p>The specification of this parameter is ignored if you omit the <code>delayedStart</code> parameter or specify NOT (no monitoring) for the <code>delayedStart</code> parameter.</p> | -- |
| delayedEnd [#] | String | <p>Specify the method of monitoring end delays, by using a character string constant specified for the <code>DelayMonitorType</code> constant. For details about the <code>DelayMonitorType</code> constant, see 7.4.11(1) DelayMonitorType.</p> <p>If you do not want to change the end delay monitor settings, do not specify this parameter, or specify <code>null</code> for this parameter.</p> <p>If you specify a constant that cannot be specified for the root jobnet, an error occurs.</p> | -- |
| delayedEndTime | string | <p>Specify the start time of end delay monitoring, by using a character string.</p> <p>You must specify this parameter if you use the <code>delayedEnd</code> parameter to change the end delay monitor settings. If you omit this parameter, an error occurs.</p> <p>If you specify <code>ABSOLUTE</code> (absolute time) for the <code>delayedEnd</code> parameter, specify the start time of end delay monitoring, by using an absolute time in <code>hh:mm</code> format.</p> <p>Specify the time by using the local time for the scheduler service of the request-destination JP1/AJS3 - Manager.</p> <p>You can specify the following values:</p> <ul style="list-style-type: none"> • <code>hh</code>: Specify the hour. You can specify the hour in the range from 00 to 47 (unit: hour). • <code>mm</code>: Specify the minute. You can specify the minute in the range from 00 to 59 (unit: minute). <p>If you specify one of the following values for the <code>delayedEnd</code> parameter, specify a relative time in <code>hh:mm</code> format: <code>ROOT</code> (relative time from the scheduled start time of the root jobnet), <code>TOP</code> (relative time from the scheduled start time of the upper jobnet), or <code>OWN</code> (relative time from the scheduled start time of the local jobnet).</p> <p>Specify the time by using the local time for the scheduler service of the request-destination JP1/AJS3 - Manager.</p> <p>You can specify the following values:</p> <ul style="list-style-type: none"> • <code>hh</code>: Specify the hour. You can specify the hour in the range from 00 to 47 (unit: hour). • <code>mm</code>: Specify the minute. You can specify the minute in the range from 00 to 59 (unit: minute). <p>However, you cannot specify 00:00. Specify a value in the range from 00:01 to 47:59.</p> <p>The specification of this parameter is ignored if you omit the <code>delayedEnd</code> parameter or specify NOT (no monitoring) for the <code>delayedEnd</code> parameter.</p> | -- |
| monitoringJobnet [#] | string | <p>Specify the method of end delay monitoring based on the time required for executing the jobnet, by</p> | -- |

| Parameter | Data type | Description of the value | Required? |
|-------------------------------|-----------|---|-----------|
| monitoringJobnet [#] | string | using a character string constant specified for the <code>MonitoringJobnetType</code> constant. For details about the <code>MonitoringJobnetType</code> constant, see 7.4.11(2) MonitoringJobnetType . If you do not want to change the setting of end delay monitoring based on the time required for executing the jobnet, do not specify this parameter, or specify <code>null</code> for this parameter. | -- |
| timeRequiredForExecution | String | When you monitor end delays based on the time required for executing the jobnet, specify the time required for execution, by using a character string. You must specify this parameter if you specify the <code>monitoringJobnet</code> parameter to change the setting of end delay monitoring based on the time required for executing the jobnet. If you omit this parameter, an error occurs. If you specify <code>TIME_REQUIRED_FOR_EXECUTION</code> (time required for execution) for the <code>monitoringJobnet</code> parameter, specify the time required for executing the jobnet in <code>hh:mm</code> format. You can specify the following values: <ul style="list-style-type: none"> hh: Specify the hour. You can specify the hour in the range from 00 to 47 (unit: hour). mm: Specify the minute. You can specify the minute in the range from 00 to 59 (unit: minute). However, you cannot specify 00:00. Specify a value in the range from 00:01 to 47:59. The specification of this parameter is ignored if you omit the <code>monitoringJobnet</code> parameter or specify <code>NOT</code> (no monitoring) for the <code>monitoringJobnet</code> parameter. | -- |

Legend:

Y: Required

--: Optional

#

Be sure to specify a procedure for monitoring one of the following: delayed start times (`delayedStart`), delayed end times (`delayedEnd`), or delayed end times that are due to the time required to execute a jobnet (`monitoringJobnet`). If you do not specify a monitoring procedure (or if `null` is specified), an error occurs.

Status code

The following table lists and describes the status codes returned as a response:

| Status code | Text description | Description |
|-------------|------------------|--|
| 200 | OK | Delay monitoring settings were changed successfully. |
| 400 | Bad Request | The argument is invalid. |
| 401 | Unauthorized | Authentication is required. |
| 403 | Forbidden | The operator does not have execution permission. |
| 404 | Not found | The operator does not have access permission for the resource, or the resource does not exist. |
| 409 | Conflict | The processing cannot be continued because the request is inconsistent with the current resource status. |

| Status code | Text description | Description |
|-------------|---------------------|--|
| 412 | Precondition failed | The Web Console server is not available. |
| 500 | Server-side error | A processing error occurred in the Web Console server. |

Return values

None (The size of the response message body is 0 bytes.)

Example 1

The following shows an example of using the API that temporarily changes the delay monitoring settings for the specified jobnet.

In this example, the API changes the delay monitoring settings as follows:

- Monitoring start delays for the jobnet starts from 08:30 (absolute time).
- Monitoring end delays for the jobnet is not set.
- End delay monitoring based on the time required for execution of the jobnet is set to 10 minutes.

Example request:

```
POST /ajs/api/v1/objects/statuses/%2FJobGroup%2FJobnet:%40A100/actions/
changeDelayMonitor/invoke HTTP/1.1
Host: HOSTW:22252
Accept-Language: ja
Content-type: application/json
X-AJS-Authorization: dXNlcjpwYXNzd29yZA==

{
  "parameters":{
    "manager":"HOSTM",
    "serviceName":"AJSROOT1",
    "delayedStart":"ABSOLUTE",
    "delayedStartTime":"08:30",
    "delayedEnd":"NOT",
    "monitoringJobnet":"TIME_REQUIRED_FOR_EXECUTION",
    "timeRequiredForExecution":"00:10"
  }
}
```

Example 2

The following shows an example of using the API that temporarily changes only the end delay monitoring setting for the specified jobnet.

Example request:

```
POST /ajs/api/v1/objects/statuses/%2FJobGroup%2FJobnet:%40A100/actions/
changeDelayMonitor/invoke HTTP/1.1
Host: HOSTW:22252
Accept-Language: ja
Content-type: application/json
X-AJS-Authorization: dXNlcjpwYXNzd29yZA==

{
  "parameters":{
    "manager":"HOSTM",
    "serviceName":"AJSROOT1",
    "delayedEnd":"OWN",
    "delayedEndTime":"00:10"
  }
}
```

```
}  
}
```

7.1.11 Change job status API

This API changes the status of the specified job.

For details about changing the job status, see *4.5.12 Changing the status of a job* in the manual *JP1/Automatic Job Management System 3 Overview*.

You can use this API only when the JP1/AJS3 - Web Console version is 11-10 or later. Before using this API, make sure that the return value of the version information acquisition API (`productVersionNumber`) is 111000 or greater.

Execution privileges

The logged in JP1 user must have one of the following JP1 permissions for the unit whose status is to be changed:

- JP1_AJS_Admin privileges
- JP1_AJS_Manager privileges
- JP1_AJS_Operator privileges

Request format

Request line

```
POST /application/component/apiVersion/objects/statuses/unitName:execID  
/actions/changeStatus/invoke httpVersion
```

Message Body

```
{  
  "parameters":{  
    "manager":"manager-host-name-or-IP-address",  
    "serviceName":"scheduler-service-name",  
    "newStatus":"status-after-change",  
    "newReturnCode":"return-code-after-change"  
  }  
}
```

API version

v1

Information that uniquely identifies a resource

The table below describes the information that uniquely identifies a resource.

If a parameter is not specified or is specified incorrectly, an error with the status code 404 occurs because the resource cannot be uniquely identified.

| Information that uniquely identifies a resource | Data type | Description | Required? |
|---|-----------|--|-----------|
| <i>unitName</i> | String | Specify the full name of the unit to be requested, by using a character string in the range from 1 to 930 bytes. | Y |
| <i>execID</i> | String | Specify the execution ID by using a character string in the format of @[<i>mmmm</i>] { <i>A to Z</i> } <i>nnnn</i> (for example, @10A200). | Y |

Legend:

Y: Required

Parameter

The following table lists and describes the parameters that can be specified for `parameters` in the request message body.

Table 7–11: List of parameters for the change job status API

| Parameter | Data type | Description of the value | Required? |
|---|-----------|---|-----------|
| <code>manager</code> | String | Specify the manager host name or IP address by using a character string in the range from 1 to 255 bytes. | Y |
| <code>serviceName</code> | String | Specify the scheduler service name by using a character string in the range from 1 to 30 bytes. | Y |
| <code>newStatus</code> [#] | string | <p>Specify the status after the change, by using a character string constant specified for the <code>ChangeStatus</code> constant. For details about the <code>ChangeStatus</code> constant, see 7.4.12(1) ChangeStatus.</p> <p>If you do not want to change the status, do not specify this parameter, or specify <code>null</code> for this parameter.</p> <p>The operation of this parameter differs depending on the type of the unit whose status is to be changed.</p> <p>The following shows the operations:</p> <ul style="list-style-type: none">• If the unit type is a jobnet connector, you can specify <code>NORMAL</code> (Ended normally), <code>WARNING</code> (Ended with warning), or <code>ABNORMAL</code> (Ended abnormally). If you specify any other value or omit this parameter, an error occurs.• If the unit type is an event job, custom event job, action job, or OR job, you cannot specify <code>RETURNCODE</code> (Judge by return code). If you specify this value, an error occurs.• You cannot specify this parameter if the type of the target unit is a judgement job, event job or custom event job defined in the start conditions. If you specify this parameter, an error occurs. | -- |
| <code>newReturnCode</code> [#] | String | <p>Specify the return code after change, as a number in the range from -2,147,483,648 to 2,147,483,647. If you do not want to change the return code, do not specify this parameter or specify <code>null</code> for this parameter.</p> <p>You cannot specify this parameter if the type of the target unit is a jobnet connector, event job or custom event job defined in the start conditions. If you specify this parameter, an error occurs.</p> | -- |

Legend:

Y: Required

--: Optional

#

Be sure to specify either the new status (`newStatus`) or the new return code (`newReturnCode`). If you do not specify either of these (or if `null` is specified), an error occurs.

Status code

The following table lists and describes the status codes returned as a response:

| Status code | Text description | Description |
|-------------|---------------------|--|
| 200 | OK | The status of the job was changed successfully. |
| 400 | Bad Request | The argument is invalid. |
| 401 | Unauthorized | Authentication is required. |
| 403 | Forbidden | The operator does not have execution permission. |
| 404 | Not found | The operator does not have access permission for the resource, or the resource does not exist. |
| 409 | Conflict | The processing cannot be continued because the request is inconsistent with the current resource status. |
| 412 | Precondition failed | The Web Console server is not available. |
| 500 | Server-side error | A processing error occurred in the Web Console server. |

Return values

None (The size of the response message body is 0 bytes.)

Example 1

The following shows an example of using the API that changes the status of the specified job.

Example request:

```
POST /ajs/api/v1/objects/statuses/%2FJobGroup%2FJobnet%2FJob:%40A100/actions/changeStatus/invoke HTTP/1.1
Host: HOSTW:22252
Accept-Language: ja
Content-type: application/json
X-AJS-Authorization: dXNlcjpwYXNzd29yZA==

{
  "parameters":{
    "manager":"HOSTM",
    "serviceName":"AJSROOT1",
    "newStatus":"NORMAL"
  }
}
```

Example 2

The following shows an example of using the API that changes the return code of the specified job.

Example request:

```
POST /ajs/api/v1/objects/statuses/%2FJobGroup%2FJobnet%2FJob:%40A100/actions/changeStatus/invoke HTTP/1.1
Host: HOSTW:22252
Accept-Language: ja
Content-type: application/json
X-AJS-Authorization: dXNlcjpwYXNzd29yZA==

{
  "parameters":{
    "manager":"HOSTM",
    "serviceName":"AJSROOT1",
    "newReturnCode":"4"
  }
}
```

Example 3

The following shows an example of using the API that changes the status and return code of the specified job.

Example request:

```
POST /ajs/api/v1/objects/statuses/%2FJobGroup%2FJobnet%2FJob:%40A100/actions/changeStatus/invoke HTTP/1.1
Host: HOSTW:22252
Accept-Language: ja
Content-type: application/json
X-AJS-Authorization: dXNlcjpwYXNzd29yZA==

{
  "parameters":{
    "manager":"HOSTM",
    "serviceName":"AJSROOT1",
    "newStatus":"ABNORMAL",
    "newReturnCode":"4"
  }
}
```

Example 4

The following shows an example of using the API that determines the status of the specified job by the return code, and then changes the job status to the specified return code.

Example request:

```
POST /ajs/api/v1/objects/statuses/%2FJobGroup%2FJobnet%2FJob:%40A100/actions/changeStatus/invoke HTTP/1.1
Host: HOSTW:22252
Accept-Language: ja
Content-type: application/json
X-AJS-Authorization: dXNlcjpwYXNzd29yZA==

{
  "parameters":{
    "manager":"HOSTM",
    "serviceName":"AJSROOT1",
    "newStatus":"RETURNCODE",
    "newReturnCode":"99"
  }
}
```

7.1.12 Change plan (change time) API

This API temporarily changes the scheduled execution start time of the specified jobnet registered for execution. After execution with the changed schedule, jobs are executed according to the schedule defined for the jobnet.

For details about temporarily changing the scheduled execution start time, see *4.5.3 Temporarily changing the execution start time of a jobnet* in the manual *JP1/Automatic Job Management System 3 Overview*.

You can use this API only when the JP1/AJS3 - Web Console version is 11-10 or later. Before using this API, make sure that the return value of the version information acquisition API (`productVersionNumber`) is 111000 or greater.

Execution privileges

The logged in JP1 user must have one of the following JP1 permissions for the unit for which the plan is to be temporarily changed (change time):

- JP1_AJS_Admin privileges
- JP1_AJS_Manager privileges
- JP1_AJS_Operator privileges

Request format

Request line

```
POST /application/component/apiVersion/objects/statuses/unitName:execID  
/actions/changeStartTime/invoke httpVersion
```

Message Body

```
{  
  "parameters": {  
    "manager": "manager-host-name-or-IP-address",  
    "serviceName": "scheduler-service-name",  
    "kindTime": "type-of-execution-start-time",  
    "absoluteTime": "execution-start-time",  
    "relativeSign": "sign-to-specify-relative-execution-start-time",  
    "relativeDay": "relative-day-to-specify-relative-execution-start-time",  
    "relativeTime": "relative-time-to-specify-execution-start-time",  
    "pushedAhead": "behavior-when-the-start-time-is-pushed-ahead",  
    "changeLower": "behavior-at-the-lower-jobnet-start-time"  
  }  
}
```

API version

v1

Information that uniquely identifies a resource

The table below describes the information that uniquely identifies a resource.

If a parameter is not specified or is specified incorrectly, an error with the status code 404 occurs because the resource cannot be uniquely identified.

| Information that uniquely identifies a resource | Data type | Description | Required? |
|---|-----------|--|-----------|
| <i>unitName</i> | String | Specify the full name of the unit to be requested, by using a character string in the range from 1 to 930 bytes. | Y |
| <i>execID</i> | String | Specify the execution ID by using a character string in the format of @ [mmmm] { A to Z } nnnn (for example, @10A200). | Y |

Legend:

Y: Required

Parameter

The following table lists and describes the parameters that can be specified for parameters in the request message body.

Table 7–12: List of parameters for the change plan (change time) API

| Parameter | Data type | Description of the value | Required? |
|----------------------------|-----------|---|-----------|
| manager | String | Specify the manager host name or IP address by using a character string in the range from 1 to 255 bytes. | Y |
| serviceName | String | Specify the scheduler service name by using a character string in the range from 1 to 30 bytes. | Y |
| kindTime | String | Specify whether to use the absolute time or relative time to specify the execution start time, by using a character constant specified for <code>ChangeStartTimeType</code> . For details about the <code>ChangeStartTimeType</code> constant, see 7.4.9(1) <i>ChangeStartTimeType</i> . | Y |
| absoluteTime ^{#1} | string | <p>When the execution start time is specified by using the absolute time, specify the execution start time in <code>YYYY-MM-DDThh:mm</code> format.</p> <p>Specify the date by using the local date for the scheduler service of the request-destination JP1/AJS3 - Manager.</p> <p>You can specify the following values:</p> <ul style="list-style-type: none"> • YYYY: specify the year. The following are the possible values for the year: If the version of JP1/AJS3 - Web Console is 13-00 or later and the version of the connection-destination JP1/AJS3 - Manager is 13-00 or later: 1994 to the value specified for the <code>SCHEDULELIMIT</code> environment setting parameter (unit: year)^{#4} In cases other than the above: 1994 to 2036 (unit: year) • MM: Specify the month. You can specify the month in the range from 01 to 12 (unit: month). • DD: Specify the day. You can specify the day in the range from 01 to the last day of the specified month (unit: day). • hh: Specify the hour. You can specify the hour in the range from 00 to 47 (unit: hour). • mm: Specify the minute. You can specify the minute in the range from 00 to 59 (unit: minute). <p>You can specify this parameter only when <code>ABSOLUTETIME</code> (specify an absolute time) is specified for the <code>kindTime</code> parameter.</p> <p>If <code>RELATIVETIME</code> (specify a relative time) is specified for the <code>kindTime</code> parameter, the specification of this parameter is ignored.</p> | -- |
| relativeSign ^{#2} | String | <p>When you specify the execution start time relative to the execution start time before a change, select + or - to specify whether to move the execution start time forward or backward.</p> <ul style="list-style-type: none"> • +: Move the execution start time forward. • -: Move the execution start time backward. <p>You can specify this parameter only when <code>RELATIVETIME</code> (specify a relative time) is specified for the <code>kindTime</code> parameter.</p> | -- |

| Parameter | Data type | Description of the value | Required? |
|-------------------------------|-----------|--|-----------|
| relativeSign ^{#2} | String | If ABSOLUTETIME (specify an absolute time) is specified for the kindTime parameter, the specification of this parameter is ignored. | -- |
| relativeDay ^{#2,#3} | Int | When you specify the execution start time relative to the execution start time before a change, specify a relative day by using a number in the range from 0 to 99. Specify the date by using the local date for the scheduler service of the request-destination JP1/AJS3 - Manager. You can specify this parameter only when RELATIVETIME (specify a relative time) is specified for the kindTime parameter. If ABSOLUTETIME (specify an absolute time) is specified for the kindTime parameter, the specification of this parameter is ignored. | -- |
| relativeTime ^{#2,#3} | string | When you specify the execution start time relative to the execution start time before a change, specify a relative time in <i>hh:mm</i> format. Specify the time by using the local time for the scheduler service of the request-destination JP1/AJS3 - Manager. You can specify the following values: <ul style="list-style-type: none"> <i>hh</i>: Specify the hour. You can specify the hour in the range from 00 to 47 (unit: hour). <i>mm</i>: Specify the minute. You can specify the minute in the range from 00 to 59 (unit: minute). You can specify this parameter only when RELATIVETIME (specify a relative time) is specified for the kindTime parameter. If ABSOLUTETIME (specify an absolute time) is specified for the kindTime parameter, the specification of this parameter is ignored. | -- |
| pushedAhead | String | If the start time of a root jobnet is pushed ahead, specify whether the execution schedule is added to the start time before a change, by using a character string constant specified for the ChangePushedAheadType constant. For details about the ChangePushedAheadType constant, see 7.4.9(2) ChangePushedAheadType . If you do not specify this parameter or specify null for this parameter, ADD (add to the next schedule) is assumed. This parameter is valid only when the unit for which the plan is temporarily changed (change time) is a root jobnet. If the unit is not a root jobnet, the specification of this parameter is ignored. | -- |
| changeLower | String | Specify whether to change the start time of nested jobnets under the specified jobnet, by using a character string constant specified for the ChangeLowerType constant. For details about the ChangeLowerType constant, see 7.4.9(3) ChangeLowerType . If you do not specify this parameter or specify null for this parameter, NOTSHIFT (the start time of lower jobnets is not changed) is assumed. | -- |

Legend:

Y: Required

--: Optional

#1

To change the date and time by specifying an absolute date and time, you need to specify the `absoluteTime` parameter. If you omit the parameter (or if `null` is specified), an error occurs.

#2

To change the date and time by specifying a relative date and time, you need to specify all the `relativeSign`, `relativeDay`, and `relativeTime` parameters. If you omit any of the parameters (or if `null` is specified), an error occurs.

#3

To change the date and time by specifying a relative date and time, make sure that the relative time is at least 1 minute. If you specify 0 for the `relativeDay` parameter and specify 00:00 for the `relativeTime` parameter, an error occurs.

#4

For details about the `SCHEDULELIMIT` environment setting parameter of the connection-destination JP1/AJS3 - Manager, see [20.4.2\(123\) SCHEDULELIMIT](#) in the *JP1/Automatic Job Management System 3 Configuration Guide*.

You can check the version of JP1/AJS3 - Web Console from the return value (`productVersionNumber`) of the version information acquisition API function. You can check the version of the connection-destination JP1/AJS3 - Manager from the return value (`protocolVersionNumber`) of the JP1/AJS3 - Manager protocol version acquisition API function.

For details about the version information acquisition API, see [7.1.37 Version information acquisition API](#).

For details about the JP1/AJS3 - Manager protocol version acquisition API, see [7.1.38 JP1/AJS3 - Manager protocol version acquisition API](#).

Status code

The following table lists and describes the status codes returned as a response:

| Status code | Text description | Description |
|-------------|---------------------|--|
| 200 | OK | The temporary change to the plan (change time) was successful. |
| 400 | Bad Request | The argument is invalid. |
| 401 | Unauthorized | Authentication is required. |
| 403 | Forbidden | The operator does not have execution permission. |
| 404 | Not found | The operator does not have access permission for the resource, or the resource does not exist. |
| 409 | Conflict | The processing cannot be continued because the request is inconsistent with the current resource status. |
| 412 | Precondition failed | The Web Console server is not available. |
| 500 | Server-side error | A processing error occurred in the Web Console server. |

Return values

None (The size of the response message body is 0 bytes.)

Example 1

The following shows an example of using the API that changes the execution start time of the specified root jobnet by specifying an absolute time.

Example request:

```
POST /ajs/api/v1/objects/statuses/%2FJobGroup%2FJobnet:%40A100/actions/
changeStartTime/invoke HTTP/1.1
Host: HOSTW:22252
Accept-Language: ja
Content-type: application/json
X-AJS-Authorization: dXNlcjpwYXNzd29yZA==

{
  "parameters":{
    "manager":"HOSTM",
    "serviceName":"AJSROOT1",
    "kindTime":"ABSOLUTETIME",
    "absoluteTime":"2016-09-07T08:30",
    "pushedAhead":"ADD",
    "changeLower":"NOTSHIFT"
  }
}
```

Example 2

The following shows an example of using the API that changes the execution start time of the specified nested jobnet by specifying a relative time.

Example request:

```
POST /ajs/api/v1/objects/statuses/%2FJobGroup%2FJobnet%2FNestJobnet:%40
A100/actions/changeStartTime/invoke HTTP/1.1
Host: HOSTW:22252
Accept-Language: ja
Content-type: application/json
X-AJS-Authorization: dXNlcjpwYXNzd29yZA==

{
  "parameters":{
    "manager":"HOSTM",
    "serviceName":"AJSROOT1",
    "kindTime":"RELATIVETIME",
    "relativeSign":"-",
    "relativeDay":0,
    "relativeTime":"01:00",
    "changeLower":"NOTSHIFT"
  }
}
```

Example 3

The following shows an example of using the API that adds an execution schedule by specifying a nested jobnet without an execution schedule.

Note that if a nested jobnet having an execution schedule is specified, the execution start time will change.

Example request:

```
POST /ajs/api/v1/objects/statuses/%2FJobGroup%2FJobnet%2FNestJobnet:%40
A100/actions/changeStartTime/invoke HTTP/1.1
```

```
Host: HOSTW:22252
Accept-Language: ja
Content-type: application/json
X-AJS-Authorization: dXNlcjpwYXNzd29yZA==

{
  "parameters":{
    "manager":"HOSTM",
    "serviceName":"AJSROOT1",
    "kindTime":"ABSOLUTETIME",
    "absoluteTime":"2016-09-07T08:30"
  }
}
```

7.1.13 Change plan (execute immediately) API

This API temporarily changes the execution schedule of the specified jobnet registered for execution, and then immediately executes the jobnet. After execution with the changed schedule, jobs are executed according to the schedule defined for the jobnet.

For details about immediate execution, see *4.5.4 Executing a registered jobnet immediately* in the manual *JP1/Automatic Job Management System 3 Overview*.

You can use this API only when the JP1/AJS3 - Web Console version is 11-10 or later. Before using this API, make sure that the return value of the version information acquisition API (`productVersionNumber`) is 111000 or greater.

Execution privileges

The logged in JP1 user must have one of the following JP1 permissions for the unit for which the plan is to be temporarily changed (execute immediately):

- JP1_AJS_Admin privileges
- JP1_AJS_Manager privileges
- JP1_AJS_Manager privileges

Request format

Request line

```
POST /application/component/apiVersion/objects/statuses/unitName:execID
/actions/execImmediate/invoke httpVersion
```

Message Body

```
{
  "parameters":{
    "manager":"manager-host-name-or-IP-address",
    "serviceName":"scheduler-service-name",
    "pushedAhead":"behavior-when-the-start-time-is-pushed-ahead",
    "changeLower":"behavior-at-the-lower-jobnet-start-time"
  }
}
```

API version

v1

Information that uniquely identifies a resource

The table below describes the information that uniquely identifies a resource.

If a parameter is not specified or is specified incorrectly, an error with the status code 404 occurs because the resource cannot be uniquely identified.

| Information that uniquely identifies a resource | Data type | Description | Required? |
|---|-----------|---|-----------|
| <i>unitName</i> | String | Specify the full name of the unit to be requested, by using a character string in the range from 1 to 930 bytes. | Y |
| <i>execID</i> | String | Specify the execution ID by using a character string in the format of @[<i>mmmm</i>] { <i>A</i> to <i>Z</i> } <i>nnnn</i> (for example, @10A200). | Y |

Legend:

Y: Required

Parameter

The following table lists and describes the parameters that can be specified for `parameters` in the request message body.

Table 7–13: List of parameters for the change plan (execute immediately) API

| Parameter | Data type | Description of the value | Required? |
|--------------------------|-----------|--|-----------|
| <code>manager</code> | String | Specify the manager host name or IP address by using a character string in the range from 1 to 255 bytes. | Y |
| <code>serviceName</code> | String | Specify the scheduler service name by using a character string in the range from 1 to 30 bytes. | Y |
| <code>pushedAhead</code> | string | If the start time of the root jobnet is pushed ahead, specify whether the execution schedule is added to the start time before a change, by using a character string constant specified for the <code>ChangePushedAheadType</code> constant. For details about the <code>ChangePushedAheadType</code> constant, see 7.4.9(2) ChangePushedAheadType . If you do not specify this parameter or specify <code>null</code> for this parameter, <code>ADD</code> (add to the next schedule) is assumed. This parameter is valid only when the unit for which the plan is temporarily changed (execute immediately) is a root jobnet. If the unit is not a root jobnet, the specification of this parameter is ignored. | -- |
| <code>changeLower</code> | String | Specify whether to change the start time of nested jobnets under the specified jobnet, by using a character string constant specified for the <code>ChangeLowerType</code> constant. For details about the <code>ChangeLowerType</code> constant, see 7.4.9(3) ChangeLowerType . If you do not specify this parameter or specify <code>null</code> for this parameter, <code>NOTSHIFT</code> (the start time of lower jobnets is not changed) is assumed. | -- |

Legend:

Y: Required

--: Optional

Status code

The following table lists and describes the status codes returned as a response:

| Status code | Text description | Description |
|-------------|---------------------|--|
| 200 | OK | The temporary change to the plan (execute immediately) was successful. |
| 400 | Bad Request | The argument is invalid. |
| 401 | Unauthorized | Authentication is required. |
| 403 | Forbidden | The operator does not have execution permission. |
| 404 | Not found | The operator does not have access permission for the resource, or the resource does not exist. |
| 409 | Conflict | The processing cannot be continued because the request is inconsistent with the current resource status. |
| 412 | Precondition failed | The Web Console server is not available. |
| 500 | Server-side error | A processing error occurred in the Web Console server. |

Return values

None (The size of the response message body is 0 bytes.)

Example

The following shows an example of using the API that temporarily changes the execution schedule of the specified jobnet, and then immediately executes the jobnet.

Example request:

```
POST /ajs/api/v1/objects/statuses/%2FJobGroup%2FJobnet:%40A100/actions/
execImmediate/invoke HTTP/1.1
Host: HOSTW:22252
Accept-Language: ja
Content-type: application/json
X-AJS-Authorization: dXNlcjpwYXNzd29yZA==

{
  "parameters": {
    "manager": "HOSTM",
    "serviceName": "AJSROOT1",
    "pushedAhead": "ADD",
    "changeLower": "NOTSHIFT"
  }
}
```

7.1.14 Change plan (execution prohibited) API

This API temporarily changes the execution schedule of the specified jobnet registered for execution, and then prohibits execution. After execution with the changed schedule, jobs are executed according to the schedule defined for the jobnet.

For details about prohibiting execution, see *4.5.5 Prohibiting execution of a job or jobnet* in the manual *JP1/Automatic Job Management System 3 Overview*.

You can use this API only when the JP1/AJS3 - Web Console version is 11-10 or later. Before using this API, make sure that the return value of the version information acquisition API (`productVersionNumber`) is 111000 or greater.

Execution privileges

The logged in JP1 user must have one of the following JP1 permissions for the unit for which the plan is to be temporarily changed (execution prohibited):

- JP1_AJS_Admin privileges
- JP1_AJS_Manager privileges
- JP1_AJS_Operator privileges

Request format

Request line

```
POST /application/component/apiVersion/objects/statuses/unitName:execID  
/actions/cancelExecSchedule/invoke httpVersion
```

Message Body

```
{  
  "parameters": {  
    "manager": "manager-host-name-or-IP-address",  
    "serviceName": "scheduler-service-name"  
  }  
}
```

API version

v1

Information that uniquely identifies a resource

The table below describes the information that uniquely identifies a resource.

If a parameter is not specified or is specified incorrectly, an error with the status code 404 occurs because the resource cannot be uniquely identified.

| Information that uniquely identifies a resource | Data type | Description | Required? |
|---|-----------|--|-----------|
| <i>unitName</i> | String | Specify the full name of the unit to be requested, by using a character string in the range from 1 to 930 bytes. | Y |
| <i>execID</i> | String | Specify the execution ID by using a character string in the format of @ [mmm] {A to Z} nnn (for example, @10A200). | Y |

Legend:

Y: Required

Parameter

The following table lists and describes the parameters that can be specified for `parameters` in the request message body.

Table 7–14: List of parameters for the change plan (execution prohibited) API

| Parameter | Data type | Description of the value | Required? |
|--------------------------|-----------|---|-----------|
| <code>manager</code> | String | Specify the manager host name or IP address by using a character string in the range from 1 to 255 bytes. | Y |
| <code>serviceName</code> | String | Specify the scheduler service name by using a character string in the range from 1 to 30 bytes. | Y |

Legend:

Y: Required

Status code

The following table lists and describes the status codes returned as a response:

| Status code | Text description | Description |
|-------------|---------------------|--|
| 200 | OK | The temporary change to the plan (execution prohibited) was successful. |
| 400 | Bad Request | The argument is invalid. |
| 401 | Unauthorized | Authentication is required. |
| 403 | Forbidden | The operator does not have execution permission. |
| 404 | Not found | The operator does not have access permission for the resource, or the resource does not exist. |
| 409 | Conflict | The processing cannot be continued because the request is inconsistent with the current resource status. |
| 412 | Precondition failed | The Web Console server is not available. |
| 500 | Server-side error | A processing error occurred in the Web Console server. |

Return values

None (The size of the response message body is 0 bytes.)

Example

The following shows an example of using the API that temporarily changes the execution schedule of the specified jobnet, and then prohibits execution.

Example request:

```
POST /ajs/api/v1/objects/statuses/%2FJobGroup%2FJobnet:%40A100/actions/
cancelExecSchedule/invoke HTTP/1.1
Host: HOSTW:22252
Accept-Language: ja
Content-type: application/json
X-AJS-Authorization: dXNlcjpwYXNzd29yZA==

{
  "parameters":{
    "manager":"HOSTM",
    "serviceName":"AJSROOT1"
  }
}
```

7.1.15 Change plan (release change) API

This API releases the temporary change of the execution start time, immediate execution and prohibited execution, and then resumes according to the information before the change. If a temporary change of the plan has been performed more than once, information is reset to the status before the first change and a temporary change is not performed.

For details on the release change, see *4.5.2 Adding an execution schedule to a jobnet* in the manual *JP1/Automatic Job Management System 3 Overview*, *4.5.3 Temporarily changing the execution start time of a jobnet* in the manual *JP1/Automatic Job Management System 3 Overview*, *4.5.4 Executing a registered jobnet immediately* in the manual

JP1/Automatic Job Management System 3 Overview, and 4.5.5 Prohibiting execution of a job or jobnet in the manual JP1/Automatic Job Management System 3 Overview.

You can use this API only when the JP1/AJS3 - Web Console version is 11-10 or later. Before using this API, make sure that the return value of the version information acquisition API (`productVersionNumber`) is 111000 or greater.

Execution privileges

The logged in JP1 user must have one of the following JP1 permissions for the unit for which the plan is to be temporarily changed (release change):

- JP1_AJS_Admin privileges
- JP1_AJS_Manager privileges
- JP1_AJS_Operator privileges

Request format

Request line

```
POST /application/component/apiVersion/objects/statuses/unitName:execID
/actions/restoreChangedSchedule/invoke httpVersion
```

Message Body

```
{
  "parameters":{
    "manager":"manager-host-name-or-IP-address",
    "serviceName":"scheduler-service-name"
  }
}
```

API version

v1

Information that uniquely identifies a resource

The table below describes the information that uniquely identifies a resource.

If a parameter is not specified or is specified incorrectly, an error with the status code 404 occurs because the resource cannot be uniquely identified.

| Information that uniquely identifies a resource | Data type | Description | Required? |
|---|-----------|---|-----------|
| <i>unitName</i> | String | Specify the full name of the unit to be requested, by using a character string in the range from 1 to 930 bytes. | Y |
| <i>execID</i> | String | Specify the execution ID by using a character string in the format of @[<i>mmmm</i>] { <i>A</i> to <i>Z</i> } <i>nnnn</i> (for example, @10A200). | Y |

Legend:

Y: Required

Parameter

The following table lists and describes the parameters that can be specified for `parameters` in the request message body.

Table 7–15: List of parameters for the change plan (release change) API

| Parameter | Data type | Description of the value | Required? |
|-------------|-----------|---|-----------|
| manager | String | Specify the manager host name or IP address by using a character string in the range from 1 to 255 bytes. | Y |
| serviceName | String | Specify the scheduler service name by using a character string in the range from 1 to 30 bytes. | Y |

Legend:

Y: Required

Status code

The following table lists and describes the status codes returned as a response:

| Status code | Text description | Description |
|-------------|---------------------|--|
| 200 | OK | The temporary change to the plan (release change) was successful. |
| 400 | Bad Request | The argument is invalid. |
| 401 | Unauthorized | Authentication is required. |
| 403 | Forbidden | The operator does not have execution permission. |
| 404 | Not found | The operator does not have access permission for the resource, or the resource does not exist. |
| 409 | Conflict | The processing cannot be continued because the request is inconsistent with the current resource status. |
| 412 | Precondition failed | The Web Console server is not available. |
| 500 | Server-side error | A processing error occurred in the Web Console server. |

Return values

None (The size of the response message body is 0 bytes.)

Example 1

The following shows an example of using the API that releases prohibited execution, immediate execution and a temporary change of the date and time for the jobnet, and then resumes according to the information before the change.

Example request:

```
POST /ajs/api/v1/objects/statuses/%2FJobGroup%2FJobnet:%40A100/actions/restoreChangedSchedule/invoke HTTP/1.1
Host: HOSTW:22252
Accept-Language: ja
Content-type: application/json
X-AJS-Authorization: dXNlcjpwYXNzd29yZA==

{
  "parameters":{
    "manager":"HOSTM",
    "serviceName":"AJSROOT1"
  }
}
```

Example 2

The following shows an example of using the API that releases the temporarily prohibited execution of the job, and then resumes according to the information before the change.

Example request:

```
POST /ajs/api/v1/objects/statuses/%2FJobGroup%2FJobnet%2FJob:%40A100/actions/restoreChangedSchedule/invoke HTTP/1.1
Host: HOSTW:22252
Accept-Language: ja
Content-type: application/json
X-AJS-Authorization: dXNlcjpwYXNzd29yZA==

{
  "parameters":{
    "manager":"HOSTM",
    "serviceName":"AJSROOT1"
  }
}
```

7.1.16 Interrupt API

This API interrupts the specified root jobnet being executed.

For details about interruption, see *4.5.9 Interrupting a jobnet* in the manual *JP1/Automatic Job Management System 3 Overview*.

You can use this API only when the JP1/AJS3 - Web Console version is 11-10 or later. Before using this API, make sure that the return value of the version information acquisition API (`productVersionNumber`) is 111000 or greater.

Execution privileges

The logged in JP1 user must have one of the following JP1 permissions for the unit to be interrupted:

- JP1_AJS_Admin privileges
- JP1_AJS_Manager privileges
- JP1_AJS_Operator privileges

Request format

Request line

```
POST /application/component/apiVersion/objects/statuses/unitName:execID/actions/interrupt/invoke httpVersion
```

Message Body

```
{
  "parameters":{
    "manager":"manager-host-name-or-IP-address",
    "serviceName":"scheduler-service-name"
  }
}
```

API version

v1

Information that uniquely identifies a resource

The table below describes the information that uniquely identifies a resource.

If a parameter is not specified or is specified incorrectly, an error with the status code 404 occurs because the resource cannot be uniquely identified.

| Information that uniquely identifies a resource | Data type | Description | Required? |
|---|-----------|---|-----------|
| <i>unitName</i> | String | Specify the full name of the unit to be requested, by using a character string in the range from 1 to 930 bytes. | Y |
| <i>execID</i> | String | Specify the execution ID by using a character string in the format of @[<i>mmmm</i>] { <i>A</i> to <i>Z</i> } <i>nnnn</i> (for example, @10A200). | Y |

Legend:

Y: Required

Parameter

The following table lists and describes the parameters that can be specified for `parameters` in the request message body.

Table 7–16: List of parameters for the interrupt API

| Parameter | Data type | Description of the value | Required? |
|--------------------|-----------|---|-----------|
| <i>manager</i> | String | Specify the manager host name or IP address by using a character string in the range from 1 to 255 bytes. | Y |
| <i>serviceName</i> | String | Specify the scheduler service name by using a character string in the range from 1 to 30 bytes. | Y |

Legend:

Y: Required

Status code

The following table lists and describes the status codes returned as a response:

| Status code | Text description | Description |
|-------------|---------------------|--|
| 200 | OK | The unit was interrupted successfully. |
| 400 | Bad Request | The argument is invalid. |
| 401 | Unauthorized | Authentication is required. |
| 403 | Forbidden | The operator does not have execution permission. |
| 404 | Not found | The operator does not have access permission for the resource, or the resource does not exist. |
| 409 | Conflict | The processing cannot be continued because the request is inconsistent with the current resource status. |
| 412 | Precondition failed | The Web Console server is not available. |
| 500 | Server-side error | A processing error occurred in the Web Console server. |

Return values

None (The size of the response message body is 0 bytes.)

Example

The following shows an example of using the API that interrupts the specified root jobnet being executed.

Example request:

```
POST /ajs/api/v1/objects/statuses/%2FJobGroup%2FJobnet:%40A100/actions/
interrupt/invoke HTTP/1.1
Host: HOSTW:22252
Accept-Language: ja
Content-type: application/json
X-AJS-Authorization: dXNlcjpwYXNzd29yZA==

{
  "parameters":{
    "manager":"HOSTM",
    "serviceName":"AJSROOT1"
  }
}
```

7.1.17 Kill API

This API kills the specified job and root jobnet that are being executed.

For details about killing a job or jobnet, see *4.5.10 Killing a job or jobnet* in the manual *JP1/Automatic Job Management System 3 Overview*.

You can use this API only when the JP1/AJS3 - Web Console version is 11-10 or later. Before using this API, make sure that the return value of the version information acquisition API (`productVersionNumber`) is 111000 or greater.

Execution privileges

The logged in JP1 user must have one of the following JP1 permissions for the unit to be killed:

- JP1_AJS_Admin privileges
- JP1_AJS_Manager privileges
- JP1_AJS_Operator privileges

Request format

Request line

```
POST /application/component/apiVersion/objects/statuses/unitName:execID
/actions/kill/invoke httpVersion
```

Message Body

```
{
  "parameters":{
    "manager":"manager-host-name-or-IP-address",
    "serviceName":"scheduler-service-name"
  }
}
```

API version

v1

Information that uniquely identifies a resource

The table below describes the information that uniquely identifies a resource.

If a parameter is not specified or is specified incorrectly, an error with the status code 404 occurs because the resource cannot be uniquely identified.

| Information that uniquely identifies a resource | Data type | Description | Required? |
|---|-----------|--|-----------|
| <i>unitName</i> | String | Specify the full name of the unit to be requested, by using a character string in the range from 1 to 930 bytes. | Y |
| <i>execID</i> | String | Specify the execution ID by using a character string in the format of @ [mmmm] { A to Z } nnnn (for example, @10A200). | Y |

Legend:

Y: Required

Parameter

The following table lists and describes the parameters that can be specified for `parameters` in the request message body.

Table 7–17: List of parameters for the kill API

| Parameter | Data type | Description of the value | Required? |
|--------------------|-----------|---|-----------|
| <i>manager</i> | string | Specify the manager host name or IP address by using a character string in the range from 1 to 255 bytes. | Y |
| <i>serviceName</i> | String | Specify the scheduler service name by using a character string in the range from 1 to 30 bytes. | Y |

Legend:

Y: Required

Status code

The following table lists and describes the status codes returned as a response:

| Status code | Text description | Description |
|-------------|---------------------|--|
| 200 | OK | The unit was killed successfully. |
| 400 | Bad Request | The argument is invalid. |
| 401 | Unauthorized | Authentication is required. |
| 403 | Forbidden | The operator does not have execution permission. |
| 404 | Not found | The operator does not have access permission for the resource, or the resource does not exist. |
| 409 | Conflict | The processing cannot be continued because the request is inconsistent with the current resource status. |
| 412 | Precondition failed | The Web Console server is not available. |
| 500 | Server-side error | A processing error occurred in the Web Console server. |

Return values

None (The size of the response message body is 0 bytes.)

Example

The following shows an example of using the API that kills the specified root jobnet being executed.

Example request:

```
POST /ajs/api/v1/objects/statuses/%2FJobGroup%2FJobnet:%40A100/actions/kill/invoke HTTP/1.1
Host: HOSTW:22252
Accept-Language: ja
Content-type: application/json
X-AJS-Authorization: dXNlcjpwYXNzd29yZA==

{
  "parameters":{
    "manager":"HOSTM",
    "serviceName":"AJSROOT1"
  }
}
```

7.1.18 Rerun API

This API reruns the specified unit.

For details on rerunning a unit, see *4.5.11 Rerunning a job or jobnet* in the manual *JP1/Automatic Job Management System 3 Overview*.

You can use this API only when the JP1/AJS3 - Web Console version is 11-10 or later. Before using this API, make sure that the return value of the version information acquisition API (`productVersionNumber`) is 111000 or greater.

Execution privileges

The logged in JP1 user must have one of the following JP1 permissions for the unit to be rerun:

- JP1_AJS_Admin privileges
- JP1_AJS_Manager privileges
- JP1_AJS_Operator privileges

Request format

Request line

```
POST /application/component/apiVersion/objects/statuses/unitName:execID/actions/rerun/invoke httpVersion
```

Message Body

```
{
  "parameters":{
    "manager":"manager-host-name-or-IP-address",
    "serviceName":"scheduler-service-name",
    "rerunMethod":"rerun-method",
    "rerunOptions":["rerun-options",...]
  }
}
```

API version

v1

Information that uniquely identifies a resource

The table below describes the information that uniquely identifies a resource.

If a parameter is not specified or is specified incorrectly, an error with the status code 404 occurs because the resource cannot be uniquely identified.

| Information that uniquely identifies a resource | Data type | Description | Required? |
|---|-----------|--|-----------|
| <i>unitName</i> | String | Specify the full name of the unit to be requested, by using a character string in the range from 1 to 930 bytes. | Y |
| <i>execID</i> | String | Specify the execution ID by using a character string in the format of @[<i>mmmm</i>] { <i>A to Z</i> } <i>nnnn</i> (for example, @10A200). | Y |

Legend:

Y: Required

Parameter

The following table lists and describes the parameters that can be specified for `parameters` in the request message body.

Table 7–18: List of parameters for the rerun API

| Parameter | Data type | Description of the value | Required? |
|---------------------------|-----------|--|-----------|
| <code>manager</code> | String | Specify the manager host name or IP address by using a character string in the range from 1 to 255 bytes. | Y |
| <code>serviceName</code> | String | Specify the scheduler service name by using a character string in the range from 1 to 30 bytes. | Y |
| <code>rerunMethod</code> | String | Specify the rerun method by using a character constant. If the unit to rerun is a root jobnet, use a character string constant specified for the <code>RootRerunType</code> constant. For details about the <code>RootRerunType</code> constant, see 7.4.10(1) RootRerunType . If the unit to rerun is a nested jobnet or job, use a character string constant specified for the <code>RerunType</code> constant. For details about the <code>RerunType</code> constant, see 7.4.10(2) RerunType . If the specified value is not appropriate for the unit type, an error occurs. | Y |
| <code>rerunOptions</code> | string[] | Specify whether to hold the unit to rerun or place an abnormal preceding unit in the <i>Ended with warning</i> status, by using an array of the character constant specified for <code>RerunOption</code> . If you do not want to specify the rerun option, specify a null string array. For details about the <code>RerunOption</code> constant, see 7.4.10(3) RerunOption . If you do not specify this parameter or specify <code>null</code> for this parameter, the system assumes that none of the rerun options are specified. If a value that cannot be specified with the rerun method (<code>rerunMethod</code>) is specified or if the specified value is not appropriate for the unit type, an error occurs. | -- |

Legend:

Y: Required

--: Optional

Status code

The following table lists and describes the status codes returned as a response:

| Status code | Text description | Description |
|-------------|---------------------|--|
| 200 | OK | The unit was rerun successfully. |
| 400 | Bad Request | The argument is invalid. |
| 401 | Unauthorized | Authentication is required. |
| 403 | Forbidden | The operator does not have execution permission. |
| 404 | Not found | The operator does not have access permission for the resource, or the resource does not exist. |
| 409 | Conflict | The processing cannot be continued because the request is inconsistent with the current resource status. |
| 412 | Precondition failed | The Web Console server is not available. |
| 500 | Server-side error | A processing error occurred in the Web Console server. |

Return values

None (The size of the response message body is 0 bytes.)

Example 1

The following shows an example of using the API that reruns jobs from the first job of the specified root jobnet.

Example request:

```
POST /ajs/api/v1/objects/statuses/%2FJobGroup%2FJobnet:%40A100/actions/
rerun/invoke HTTP/1.1
Host: HOSTW:22252
Accept-Language: ja
Content-type: application/json
X-AJS-Authorization: dXNlcjpwYXNzd29yZA==

{
  "parameters":{
    "manager":"HOSTM",
    "serviceName":"AJSROOT1",
    "rerunMethod":"TOP",
    "rerunOptions":[]
  }
}
```

Example 2

The following shows an example of using the API that reruns jobs by specifying the rerun options.

Example request:

```
POST /ajs/api/v1/objects/statuses/%2FJobGroup%2FJobnet%2FJob:%40A100/ac
tions/rerun/invoke HTTP/1.1
Host: HOSTW:22252
Accept-Language: ja
Content-type: application/json
X-AJS-Authorization: dXNlcjpwYXNzd29yZA==

{
  "parameters":{
    "manager":"HOSTM",
```



```

    "serviceName": "AJSROOT1",
    "rerunMethod": "FROM",
    "rerunOptions": ["HOLD", "WARNING"]
  }
}

```

7.1.19 Wait status change API

This API function temporarily changes the wait status of a unit with wait conditions (whether a unit with wait conditions is still waiting for the end of the waiting-target unit).

For details about changing wait statuses, see *2.2.5 Using wait conditions to control the order of unit execution in the JP1/Automatic Job Management System 3 System Design (Work Tasks) Guide*.

You can use this API function if the version of JP1/AJS3 - Web Console is 12-50 or later. Before you use this API function, execute the version number acquisition API function and confirm that the return value (`productVersionNumber`) is 125000 or larger.

Execution privileges

The logged-in JP1 user must have one of the following JP1 permissions for the unit whose wait statuses are to be changed:

- JP1_AJS_Admin privileges
- JP1_AJS_Manager privileges
- JP1_AJS_Operator privileges

Request format

Request line

```
POST /application/component/apiVersion/objects/waiting/unitName:execID/
actions/changeWaiting/invoke httpVersion
```

Message Body

```

{
  "parameters": {
    "manager": "manager-host-name-or-IP-address",
    "serviceName": "scheduler-service-name",
    "waitingTargetUnitName": "full-name-of-unit-being-waited-for",
    "waitingStatusAction": "whether-to-enable-waiting"
  }
}

```

API version

v1

Information that uniquely identifies a resource

The table below describes the information that uniquely identifies a resource.

If a parameter is not specified or is specified incorrectly, an error with the status code 404 occurs because the resource cannot be uniquely identified.

| Information that uniquely identifies a resource | Data type | Description of the value | Required? |
|---|-----------|---|-----------|
| <i>unitName</i> | string | Specify the full name of the unit to be requested, by using a character string in the range from 1 to 930 bytes. | Y |
| <i>execID</i> | string | Specify the execution ID by using a character string in the format of @[<i>mmmm</i>] { <i>A</i> to <i>Z</i> } <i>nnnn</i> (for example, @10A200). | Y |

Parameter

The following table lists and describes the parameters that can be specified for `parameters` in the request message body.

Table 7–19: List of parameters for the Wait status change API

| Parameter | Data type | Description of the value | Required? |
|------------------------------------|-----------|---|-----------|
| <code>manager</code> | string | Specify the manager host name or IP address by using a character string in the range from 1 to 255 bytes. | Y |
| <code>serviceName</code> | string | Specify the scheduler service name by using a character string in the range from 1 to 30 bytes. | Y |
| <code>waitingTargetUnitName</code> | string | Specify the full name of the unit being waited for, by using a character string in the range from 1 to 930 bytes. | Y |
| <code>waitingStatusAction</code> | string | Specify whether to enable or disable waiting by using a character string constant that is supported by the <code>WaitingStatusAction</code> constant. For details about the <code>WaitingStatusAction</code> constant, see 7.4.13(4) <i>WaitingStatusAction</i> . | Y |

Status code

The following table lists and describes the status codes returned as a response:

| Status code | Text description | Description |
|-------------|---------------------|--|
| 200 | OK | The wait status was changed successfully. |
| 400 | Bad Request | The argument is invalid. |
| 401 | Unauthorized | Authentication is required. |
| 403 | Forbidden | The operator does not have execution permission. |
| 404 | Not found | The operator does not have access permission for the resource, or the resource does not exist. |
| 409 | Conflict | The processing cannot be continued because the request is inconsistent with the current resource status. |
| 412 | Precondition failed | The Web Console server is not available. |
| 500 | Server-side error | A processing error occurred in the Web Console server. |

Return values

None (The size of the response message body is 0 bytes.)

Example

The following shows an example of using the API to change the wait status.

Example request:

```
POST /ajs/api/v1/objects/waiting/%2FJobGroup%2FJobnet01:%40A104/actions/changeWaiting/invoke HTTP/1.1
```

```

Host: HOSTW:22252
Accept-Language: ja
Content-Type: application/json
X-AJS-Authorization: dXNlcjpwYXNzd29yZA==

{
  "parameters":{
    "manager":"HOSTM",
    "serviceName":"AJSROOT1",
    "waitingTargetUnitName":"/JobGroup/Jobnet02",
    "waitingStatusAction":"DISABLE"
  }
}

```

7.1.20 Execution order control method change API

This API temporarily changes the execution order control method for the root jobnet.

For details about methods for controlling the execution order, see *2.2.4 Using jobnet connectors to control the order of root jobnet execution* in the *JP1/Automatic Job Management System 3 System Design (Work Tasks) Guide*.

You can use this API function if the version of JP1/AJS3 - Web Console is 12-50 or later. Before you use this API function, execute the version number acquisition API function and confirm that the return value (`productVersionNumber`) is 125000 or larger.

Execution privileges

The logged-in JP1 user must have one of the following JP1 permissions for the root jobnet for which the execution order control method is to be changed:

- JP1_AJS_Admin privileges
- JP1_AJS_Manager privileges
- JP1_AJS_Operator privileges

Request format

Request line

```

POST /application/component/apiVersion/objects/statuses/unitName:execID
/actions/changeExecOrderMethod/invoke httpVersion

```

Message Body

```

{
  "parameters":{
    "manager":"manager-host-name-or-IP-address",
    "serviceName":"scheduler-service-name",
    "execOrderMethod":"new-execution-order-control-method"
  }
}

```

API version

v1

Information that uniquely identifies a resource

The table below describes the information that uniquely identifies a resource.

If a parameter is not specified or is specified incorrectly, an error with the status code 404 occurs because the resource cannot be uniquely identified.

| Information that uniquely identifies a resource | Data type | Description of the value | Required? |
|---|-----------|---|-----------|
| <i>unitName</i> | string | Specify the full name of the unit to be requested, by using a character string in the range from 1 to 930 bytes. | Y |
| <i>execID</i> | string | Specify the execution ID by using a character string in the format of @[mmmm]{A to Z}nnnn (for example, @10A200). | Y |

Parameter

The following table lists and describes the parameters that can be specified for `parameters` in the request message body.

Table 7–20: List of parameters for the Execution order control method change API

| Parameter | Data type | Description of the value | Required? |
|------------------------------|-----------|---|-----------|
| <code>manager</code> | string | Specify the manager host name or IP address by using a character string in the range from 1 to 255 bytes. | Y |
| <code>serviceName</code> | string | Specify the scheduler service name by using a character string in the range from 1 to 30 bytes. | Y |
| <code>execOrderMethod</code> | string | Specify whether to change the execution order control method to the synchronous method or the asynchronous method by using a character string constant that is supported by the <code>ChangeExecOrderMethod</code> constant. For details about the <code>ChangeExecOrderMethod</code> constant, see 7.4.15(1) ChangeExecOrderMethod . | Y |

Status code

The following table lists and describes the status codes returned as a response:

| Status code | Text description | Description |
|-------------|---------------------|--|
| 200 | OK | The execution order control method was changed successfully. |
| 400 | Bad Request | The argument is invalid. |
| 401 | Unauthorized | Authentication is required. |
| 403 | Forbidden | The operator does not have execution permission. |
| 404 | Not found | The operator does not have access permission for the resource, or the resource does not exist. |
| 409 | Conflict | The processing cannot be continued because the request is inconsistent with the current resource status. |
| 412 | Precondition failed | The Web Console server is not available. |
| 500 | Server-side error | A processing error occurred in the Web Console server. |

Return values

None (The size of the response message body is 0 bytes.)

Example

The following shows an example of using the API to change the execution order control method for the specified root jobnet to synchronous method.

Example request:

```
POST /ajs/api/v1/objects/statuses/%2FJobGroup%2FJobnet:%40A111/actions/
changeExecOrderMethod/invoke HTTP/1.1
Host: HOSTW:22252
Accept-Language: ja
Content-Type: application/json
X-AJS-Authorization: dXNlcjpwYXNzd29yZA==

{
  "parameters":{
    "manager":"HOSTM",
    "serviceName":"AJSROOT1",
    "execOrderMethod":"SYNC"
  }
}
```

7.1.21 Execution agent status list acquisition API

This API acquires a list of the statuses of the execution agents that are registered on the manager host.

You can use this API function only if the version of JP1/AJS3 - Web Console is 12-50 or later and the version of the connection-destination JP1/AJS3 - Manager is 12-50 or later. Before you use this API function, confirm that: the return value (`productVersionNumber`) of the version information acquisition API function is 125000 or larger; and the return value (`protocolVersionNumber`) of the JP1/AJS3 - Manager protocol version acquisition API function is 1250 or larger.

Execution privileges

The logged-in JP1 user must have one of the following JP1 permissions:

- JP1_JPQ_Admin privileges
- JP1_JPQ_Operator privileges
- JP1_JPQ_User privileges

Request format

Request line

```
GET /application/component/apiVersion/objects/execAgents/statuses?query httpVersion
```

API version

v1

Information that uniquely identifies a resource

None

Parameter

The following table lists and describes the parameters that can be specified for `query`.

Table 7–21: List of parameters for the Execution agent status list acquisition API

| Parameter | Description of the value | Required? |
|-----------|---|-----------|
| manager | Specify the manager host name or IP address by using a character string in the range from 1 to 255 bytes. | Y |

| Parameter | Description of the value | Required? |
|-----------|--|-----------|
| mode | Specify a character string that indicates the acquisition-target mode. Specify agent for this parameter. | Y |

Status code

The following table lists and describes the status codes returned as a response:

| Status code | Text description | Description |
|-------------|---------------------|--|
| 200 | OK | A list of the statuses of execution agents was acquired successfully. |
| 400 | Bad Request | The query character string is invalid. |
| 401 | Unauthorized | Authentication is required. |
| 403 | Forbidden | The operator does not have execution permission. |
| 404 | Not found | The operator does not have access permission for the resource, or the resource does not exist. |
| 412 | Precondition failed | The Web Console server is not available. |
| 500 | Server-side error | A processing error occurred in the Web Console server. |

Response format

Response message body

```
{
  "results": [Execution-agent-operation-result-object]
}
```

Return values

If the status code is 200, the following information is returned:

| Member | Data type | Description |
|---------|-----------|--|
| results | object[] | Returns an array of the execution agent operation result objects. In the returned array, the result of acquiring the statuses of execution agents is stored in element 0. Also, if the command terminates abnormally on the manager host, a non-zero value is stored as the result code of the target processing and KNAK3696-E is stored as a message in the returned array. For details about the execution agent operation result object, see 7.3.6 Execution agent operation result object . |

Example

The following shows an example of using the API to acquire a status list of execution agents.

Example request:

```
GET /ajs/api/v1/objects/execAgents/statuses?manager=HOSTM&mode=agent HTTP/1.1
Host: HOSTW:22252
Accept-Language: ja
X-AJS-Authorization: dXNlcjpwYXNzd29yZA==
```

Example response (message body):

```
{
  "results":
```

```

[
  {
    "execAgent": "",
    "rtnCode": "0",
    "output":
    {
      "text": "",
      "serverTime": "2020-08-26T09:09:14+09:00",
      "statuses":
      [
        {
          "comStatus": "NOTCHECKED",
          "conExe": 5,
          "status": "EFFECTIVE",
          "description": "",
          "execAgent": "@SYSTEM",
          "execHost": "HISOL8139682",
          "que": 0,
          "job": 0,
          "event": 0
        },
        {
          "comStatus": "NOTCHECKED",
          "conExe": 20,
          "status": "BLOCKADE",
          "description": "test",
          "execAgent": "AGT01",
          "execHost": "AGT01",
          "que": 0,
          "job": 0,
          "event": 0
        }
      ],
      "definitions": null
    }
  }
]

```

7.1.22 Execution agent status acquisition API

This API acquires the status of an execution agent that is registered on the manager host.

If the target execution agent does not exist, the API returns the result of execution agent status acquisition as an empty object (zero-element object).

You can use this API function only if the version of JP1/AJS3 - Web Console is 12-50 or later and the version of the connection-destination JP1/AJS3 - Manager is 12-50 or later. Before you use this API function, confirm that: the return value (`productVersionNumber`) of the version information acquisition API function is 125000 or larger; and the return value (`protocolVersionNumber`) of the JP1/AJS3 - Manager protocol version acquisition API function is 1250 or larger.

Execution privileges

The logged-in JP1 user must have one of the following JP1 permissions:

- JP1_JPQ_Admin privileges
- JP1_JPQ_Operator privileges
- JP1_JPQ_User privileges

Request format

Request line

```
GET /application/component/apiVersion/objects/execAgents/statuses?query httpVersion
```

API version

v1

Information that uniquely identifies a resource

None

Parameter

The following table lists and describes the parameters that can be specified for `query`.

Table 7–22: List of parameters for the Execution agent status acquisition API

| Parameter | Description of the value | Required? |
|-----------|---|-----------|
| manager | Specify the manager host name or IP address by using a character string in the range from 1 to 255 bytes. | Y |
| mode | Specify a character string that indicates the acquisition-target mode. Specify agent for this parameter. | Y |
| execAgent | Specify the execution agent name by using a character string in the range from 1 to 255 bytes. | Y |

Status code

The following table lists and describes the status codes returned as a response:

| Status code | Text description | Description |
|-------------|---------------------|--|
| 200 | OK | The status of the execution agent was acquired successfully. |
| 400 | Bad Request | The query character string is invalid. |
| 401 | Unauthorized | Authentication is required. |
| 403 | Forbidden | The operator does not have execution permission. |
| 404 | Not found | The operator does not have access permission for the resource, or the resource does not exist. |
| 412 | Precondition failed | The Web Console server is not available. |
| 500 | Server-side error | A processing error occurred in the Web Console server. |

Response format

Response message body

```
{
  "results": [Execution-agent-operation-result-object]
}
```

Return values

If the status code is 200, the following information is returned:

| Member | Data type | Description |
|---------|-----------|--|
| results | object[] | Returns an array of the execution agent operation result objects. In the returned array, the result of acquiring the statuses of execution agents is stored in element 0. Also, if the command terminates abnormally on the manager host, a non-zero value is stored as the result code of the target processing and KNAK3696-E is stored as a message in the returned array. For details about the execution agent operation result object, see 7.3.6 Execution agent operation result object . |

Example

The following shows an example of using the API to acquire the statuses of execution agents.

Example request:

```
GET /ajs/api/v1/objects/execAgents/statuses?manager=HOSTM&mode=agent&execAgent=AGT01 HTTP/1.1
Host: HOSTW:22252
Accept-Language: ja
X-AJS-Authorization: dXNlcjpwYXNzd29yZA==
```

Example response (message body):

```
{
  "results":
  [
    {
      "execAgent": "",
      "rtnCode": "0",
      "output":
      {
        "text": "",
        "serverTime": "2020-08-26T09:19:07+09:00",
        "statuses":
        [
          {
            "comStatus": "NOTCHECKED",
            "conExe": 20,
            "status": "BLOCKADE",
            "description": "test",
            "execAgent": "AGT01",
            "execHost": "AGT01",
            "que": 0,
            "job": 0,
            "event": 0
          }
        ],
        "definitions": null
      }
    }
  ]
}
```

7.1.23 Execution agent definition acquisition API

This API acquires the definitions of the execution agents that are registered on the manager host.

You can use this API function only if the version of JP1/AJS3 - Web Console is 12-50 or later and the version of the connection-destination JP1/AJS3 - Manager is 12-50 or later. Before you use this API function, confirm that: the return value (`productVersionNumber`) of the version information acquisition API function is 125000 or larger; and the return value (`protocolVersionNumber`) of the JP1/AJS3 - Manager protocol version acquisition API function is 1250 or larger.

Execution privileges

The logged-in JP1 user must have one of the following JP1 permissions:

- JP1_JPQ_Admin privileges
- JP1_JPQ_Operator privileges
- JP1_JPQ_User privileges

Request format

Request line

```
GET /application/component/apiVersion/objects/execAgents/definitions?query httpVersion
```

API version

v1

Information that uniquely identifies a resource

None

Parameter

The following table lists and describes the parameters that can be specified for `query`.

Table 7–23: List of parameters for the Execution agent definition acquisition API

| Parameter | Description of the value | Required? |
|------------------------|---|-----------|
| <code>manager</code> | Specify the manager host name or IP address by using a character string in the range from 1 to 255 bytes. | Y |
| <code>mode</code> | Specify a character string that indicates the acquisition-target mode. Specify <code>agent</code> for this parameter. | Y |
| <code>execAgent</code> | Specify the execution agent name by using a character string in the range from 1 to 255 bytes. | Y |

Status code

The following table lists and describes the status codes returned as a response:

| Status code | Text description | Description |
|-------------|---------------------|--|
| 200 | OK | Execution agent definitions were acquired successfully. |
| 400 | Bad Request | The query character string is invalid. |
| 401 | Unauthorized | Authentication is required. |
| 403 | Forbidden | The operator does not have execution permission. |
| 404 | Not found | The operator does not have access permission for the resource, or the resource does not exist. |
| 412 | Precondition failed | The Web Console server is not available. |
| 500 | Server-side error | A processing error occurred in the Web Console server. |

Response format

Response message body

```
{
  "results": [Execution-agent-operation-result-object]
}
```

Return values

If the status code is 200, the following information is returned:

| Member | Data type | Description |
|---------|-----------|---|
| results | object[] | Returns an array of the execution agent operation result objects. In the returned array, the result of acquiring execution agent definitions is stored in element 0. Also, if the command terminates abnormally on the manager host, a non-zero value is stored as the result code of the target processing and KNAK3696-E is stored as a message in the returned array. For details about the execution agent operation result object, see 7.3.6 Execution agent operation result object . |

Example

The following shows an example of using the API to acquire the definitions of execution agents.

Example request:

```
GET /ajs/api/v1/objects/execAgents/definitions?manager=HOSTM&mode=agent
&execAgent=AGT01 HTTP/1.1
Host: HOSTW:22252
Accept-Language: ja
X-AJS-Authorization: dXNlcjpwYXNzd29yZA==
```

Example response (message body):

```
{
  "results":
  [
    {
      "rtnCode": "0",
      "output":
      {
        "definitions":
        [
          {
            "conExe":
            [
              "00:00-00:00=20"
            ],
            "status": "BLOCKADE",
            "description": "test",
            "execAgent": "AGT01",
            "execHost": "AGT01"
          }
        ],
        "statuses": null,
        "text": "",
        "serverTime": ""
      },
      "execAgent": ""
    }
  ]
}
```

```
}
  ]
}
```

7.1.24 Execution agent addition API

This API adds an execution agent to the manager host.

You can use this API function only if the version of JP1/AJS3 - Web Console is 12-50 or later and the version of the connection-destination JP1/AJS3 - Manager is 12-50 or later. Before you use this API function, confirm that: the return value (`productVersionNumber`) of the version information acquisition API function is 125000 or larger; and the return value (`protocolVersionNumber`) of the JP1/AJS3 - Manager protocol version acquisition API function is 1250 or larger.

Execution privileges

The logged-in JP1 user must have the following JP1 permission:

- JP1_JPQ_Admin privileges

Request format

Request line

```
POST /application/component/apiVersion/objects/execAgents httpVersion
```

Message Body

```
{
  "parameters":{
    "manager":"manager-host-name-or-IP-address",
    "mode":"target-mode",
    "execAgent":"execution-agent-name",
    "execHost":"execution-host-name",
    "timePeriods":[{"
      "timePeriod":"time-period",
      "conExe":maximum-number-of-concurrently-executable-jobs
    },...],
    "status":"job-transfer-restriction-status-of-execution-agent",
    "description":"comment"
  }
}
```

API version

v1

Information that uniquely identifies a resource

None

Parameter

The following table lists and describes the parameters that can be specified for `parameters` in the request message body.

Table 7–24: List of parameters for the Execution agent addition API

| Parameter | Data type | Description of the value | Required? |
|-------------|-----------|--|-----------|
| manager | string | Specify the manager host name or IP address by using a character string in the range from 1 to 255 bytes. | Y |
| mode | string | Specify a character string that indicates the target mode. Specify <code>agent</code> for this parameter. | Y |
| execAgent | string | Specify the execution agent name by using a character string in the range from 1 to 255 bytes. | Y |
| execHost | string | Specify the name of the job execution host, by using a character string of no more than 255 bytes. If you do not want to specify the job execution host, do not specify this parameter, alternatively, specify a null (zero-byte) string. | -- |
| timePeriods | object[] | Specify the maximum number of concurrently executable jobs by using an object array. If you do not want to specify the maximum number of concurrently executable jobs, do not specify this parameter, alternatively, specify an empty object (zero-element object) or the string <code>null</code> . | -- |
| timePeriod | string | Specify (in <code>hh:mm-hh:mm</code> format) the time period in which the specified maximum number of concurrently executable jobs applies. You can specify the following values: <ul style="list-style-type: none"> <code>hh</code>: Specify the hour. You can specify the hour in the range from 00 to 23 (unit: hour). <code>mm</code>: Specify the minute. For <code>mm</code>, you can specify only 00 or 30 (unit: minute). | Y |
| conExe | long | Specify the maximum number of jobs that can be concurrently executed in the specified time period. You can specify a numeric value in the range from 0 to 4294967295. | Y |
| status | string | Specify the job transfer restriction status of an execution agent by using a character string constant that is supported by the <code>ExecAgentStatus</code> constant. For details about the <code>ExecAgentStatus</code> constant, see 7.4.14(1) ExecAgentStatus . If you do not want to specify the job transfer restriction status of an execution agent, do not specify this parameter, alternatively, specify a null (zero-byte) string. | -- |
| description | string | Specify a description by using a character string of no more than 80 bytes. If you do not want to specify a description, do not specify this parameter, alternatively, specify a null (zero-byte) string. | -- |

Status code

The following table lists and describes the status codes returned as a response:

| Status code | Text description | Description |
|-------------|------------------|--|
| 200 | OK | An execution agent was added successfully. |
| 400 | Bad Request | The argument is invalid. |
| 401 | Unauthorized | Authentication is required. |

| Status code | Text description | Description |
|-------------|---------------------|--|
| 403 | Forbidden | The operator does not have execution permission. |
| 404 | Not found | The operator does not have access permission for the resource, or the resource does not exist. |
| 412 | Precondition failed | The Web Console server is not available. |
| 500 | Server-side error | A processing error occurred in the Web Console server. |

Response format

Response message body

```
{
  "results": [Execution-agent-operation-result-object]
}
```

Return values

If the status code is 200, the following information is returned:

| Member | Data type | Description |
|---------|-----------|---|
| results | object[] | Returns an array of the execution agent operation result objects. In the returned array, the result of adding an execution agent is stored in element 0. Also, if the command terminates abnormally on the manager host, a non-zero value is stored as the result code of the target processing and KNAK3696-E is stored as a message in the returned array. For details about the execution agent operation result object, see 7.3.6 Execution agent operation result object . |

Cautionary note

Even if an error has occurred in JP1/AJS3 - Web Console, the operation on the execution agent might be successful on the manager host.

Example

The following shows an example of using the API to add an execution agent.

Example request:

```
POST /ajs/api/v1/objects/execAgents HTTP/1.1
Host: HOSTW:22252
Accept-Language: ja
Content-Type: application/json
X-AJS-Authorization: dXNlcjpwYXNzd29yZA==

{
  "parameters": {
    "manager": "HOSTM",
    "mode": "agent",
    "execAgent": "AGT01",
    "execHost": "AGT01",
    "timePeriods": [ {
      "timePeriod": "00:00-00:00",
      "conExe": 20
    } ],
    "status": "BLOCKADE",
    "description": "test"
  }
}
```

Example response (message body):

```
{
  "results":
  [
    {
      "rtnCode": "0",
      "output": null,
      "execAgent": "AGT01"
    }
  ]
}
```

7.1.25 Execution agent deletion API

This API deletes the specified execution agent from the manager host. You can also delete multiple execution agents at one time.

You can use this API function only if the version of JP1/AJS3 - Web Console is 12-50 or later and the version of the connection-destination JP1/AJS3 - Manager is 12-50 or later. Before you use this API function, confirm that: the return value (`productVersionNumber`) of the version information acquisition API function is 125000 or larger; and the return value (`protocolVersionNumber`) of the JP1/AJS3 - Manager protocol version acquisition API function is 1250 or larger.

Execution privileges

The logged-in JP1 user must have the following JP1 permission:

- JP1_JPQ_Admin privileges

Request format

Request line

```
POST /application/component/apiVersion/objects/execAgents/actions/delete/invoke httpVersion
```

Message Body

```
{
  "parameters": {
    "manager": "manager-host-name-or-IP-address",
    "mode": "target-mode",
    "execAgents": ["execution-agent-name", ...]
  }
}
```

API version

v1

Information that uniquely identifies a resource

None

Parameter

The following table lists and describes the parameters that can be specified for `parameters` in the request message body.

Table 7–25: List of parameters for the Execution agent deletion API

| Parameter | Data type | Description of the value | Required? |
|------------|-----------|--|-----------|
| manager | string | Specify the manager host name or IP address by using a character string in the range from 1 to 255 bytes. | Y |
| mode | string | Specify a character string that indicates the target mode. Specify <code>agent</code> for this parameter. | Y |
| execAgents | string[] | Specify a string array of the names of the execution agents to be deleted. You can specify a maximum of 100 execution agents. Each execution agent name must be a character string in the range from 1 to 255 bytes. | Y |

Status code

The following table lists and describes the status codes returned as a response:

| Status code | Text description | Description |
|-------------|---------------------|--|
| 200 | OK | The execution agents were deleted successfully. |
| 400 | Bad Request | The argument is invalid. |
| 401 | Unauthorized | Authentication is required. |
| 403 | Forbidden | The operator does not have execution permission. |
| 404 | Not found | The operator does not have access permission for the resource, or the resource does not exist. |
| 412 | Precondition failed | The Web Console server is not available. |
| 500 | Server-side error | A processing error occurred in the Web Console server. |

Response format

Response message body

```
{
  "results": [Execution-agent-operation-result-object, ...]
}
```

Return values

If the status code is 200, the following information is returned:

| Member | Data type | Description |
|---------|-----------|---|
| results | object[] | Returns an array of the execution agent operation result objects. The number of array elements is the same as the number of elements in the array specified for the <code>execAgents</code> parameter. Also, if the command terminates abnormally on the manager host, a non-zero value is stored as the result code of the target processing and <code>KNAK3696-E</code> is stored as a message in the returned array. For details about the execution agent operation result object, see 7.3.6 Execution agent operation result object . |

Cautionary note

Even if an error has occurred in JP1/AJS3 - Web Console, the operation on the execution agent might be successful on the manager host.

Example

The following shows an example of using the API to delete an execution agent.

Example request:

```
POST /ajs/api/v1/objects/execAgents/actions/delete/invoke HTTP/1.1
Host: HOSTW:22252
Accept-Language: ja
Content-Type: application/json
X-AJS-Authorization: dXNlcjpwYXNzd29yZA==

{
  "parameters":{
    "manager":"HOSTM",
    "mode":"agent",
    "execAgents":["AGT01"]
  }
}
```

Example response (message body):

```
{
  "results":
  [
    {
      "rtnCode":"0",
      "output":null,
      "execAgent":"AGT01"
    }
  ]
}
```

7.1.26 Execution agent reconfiguration API

This API changes the settings of an execution agent that is set on the manager host.

You can use this API function only if the version of JP1/AJS3 - Web Console is 12-50 or later and the version of the connection-destination JP1/AJS3 - Manager is 12-50 or later. Before you use this API function, confirm that: the return value (`productVersionNumber`) of the version information acquisition API function is 125000 or larger; and the return value (`protocolVersionNumber`) of the JP1/AJS3 - Manager protocol version acquisition API function is 1250 or larger.

Execution privileges

The logged-in JP1 user must have the following JP1 permission:

- JP1_JPQ_Admin privileges

Request format

Request line

```
POST /application/component/apiVersion/objects/execAgents/actions/update/invoke httpVersion
```

Message Body

```
{
  "parameters":{
    "manager":"manager-host-name-or-IP-address",
    "mode":"target-mode",
  }
}
```

```

    "execAgent": "execution-agent-name",
    "execHost": "execution-host-name",
    "timePeriods": [{
    "timePeriod": "time-period",
    "conExe": maximum-number-of-concurrently-executable-jobs
    }, ...],
    "description": "comment"
  }
}

```

API version

v1

Information that uniquely identifies a resource

None

Parameter

The following table lists and describes the parameters that can be specified for `parameters` in the request message body.

Table 7–26: List of parameters for the Execution agent reconfiguration API

| Parameter | Data type | Description of the value | Required? |
|--------------------------------------|-----------|--|-----------|
| <code>manager</code> | string | Specify the manager host name or IP address by using a character string in the range from 1 to 255 bytes. | Y |
| <code>mode</code> | string | Specify a character string that indicates the target mode. Specify <code>agent</code> for this parameter. | Y |
| <code>execAgent</code> | string | Specify the name of the execution agent whose settings are to be changed, by using a character string in the range from 1 to 255 bytes. | Y |
| <code>execHost[#]</code> | string | Specify the name of the job execution host by using a character string in the range from 1 to 255 bytes. If you do not want to change the name of the job execution host, do not specify this parameter. | -- |
| <code>timePeriods[#]</code> | object[] | Specify the maximum number of concurrently executable jobs as an object array. If you specify this parameter, you must specify at least one maximum number of concurrently executable jobs. If you do not want to change the maximum number of concurrently executable jobs, do not specify this parameter. | -- |
| <code>timePeriod</code> | string | Specify (in <code>hh:mm-hh:mm</code> format) the time period during which the specified maximum number of concurrently executable jobs applies. You can specify the following values: <ul style="list-style-type: none"> <code>hh</code>: Specify the hour. You can specify the hour in the range from 00 to 23 (unit: hour). <code>mm</code>: Specify the minute. For <code>mm</code>, you can specify only 00 or 30 (unit: minute). | Y |
| <code>conExe</code> | long | Specify the maximum number of jobs that can be concurrently executed in the specified time period. You can specify a numeric value in the range from 0 to 4294967295. | Y |

| Parameter | Data type | Description of the value | Required? |
|--------------|-----------|--|-----------|
| description# | string | Specify a description by using a character string of no more than 80 bytes. If you do not want to change the description, do not specify this parameter. | -- |

#

You must specify one or more of the following: the name of the job execution host, the maximum number of concurrently executable jobs, and the description.

Status code

The following table lists and describes the status codes returned as a response:

| Status code | Text description | Description |
|-------------|---------------------|--|
| 200 | OK | The settings of the execution agent were changed successfully. |
| 400 | Bad Request | The argument is invalid. |
| 401 | Unauthorized | Authentication is required. |
| 403 | Forbidden | The operator does not have execution permission. |
| 404 | Not found | The operator does not have access permission for the resource, or the resource does not exist. |
| 412 | Precondition failed | The Web Console server is not available. |
| 500 | Server-side error | A processing error occurred in the Web Console server. |

Response format

Response message body

```
{
  "results": [Execution-agent-operation-result-object]
}
```

Return values

If the status code is 200, the following information is returned:

| Member | Data type | Description |
|---------|-----------|---|
| results | object[] | Returns an array of the execution agent operation result objects. In the returned array, the result of changing the execution agent settings is stored in element 0. Also, if the command terminates abnormally on the manager host, a non-zero value is stored as the result code of the target processing and KNAK3696-E is stored as a message in the returned array. For details about the execution agent operation result object, see 7.3.6 Execution agent operation result object . |

Cautionary note

Even if an error has occurred in JP1/AJS3 - Web Console, the operation on the execution agent might be successful on the manager host.

Example

The following shows an example of using the API to change the settings of an execution agent.

Example request:

```
POST /ajs/api/v1/objects/execAgents/actions/update/invoke HTTP/1.1
Host: HOSTW:22252
```

```

Accept-Language: ja
Content-Type: application/json
X-AJS-Authorization: dXNlcjpwYXNzd29yZA==

{
  "parameters":{
    "manager":"HOSTM",
    "mode":"agent",
    "execAgent":"AGT01",
    "execHost":"AGT01",
    "timePeriods":[{
      "timePeriod":"00:00-00:00",
      "conExe":30
    }],
    "description":"TEST"
  }
}

```

Example response (message body):

```

{
  "results":
  [
    {
      "rtnCode":"0",
      "output":null,
      "execAgent":"AGT01"
    }
  ]
}

```

7.1.27 API to change the job transfer restriction status of an execution agent

This API changes the job transfer restriction status of an execution agent that is registered on the manager host. You can also specify multiple execution agents to change their job transfer restriction statuses.

You can use this API function only if the version of JP1/AJS3 - Web Console is 12-50 or later and the version of the connection-destination JP1/AJS3 - Manager is 12-50 or later. Before you use this API function, confirm that: the return value (`productVersionNumber`) of the version information acquisition API function is 125000 or larger; and the return value (`protocolVersionNumber`) of the JP1/AJS3 - Manager protocol version acquisition API function is 1250 or larger.

Execution privileges

The logged-in JP1 user must have one of the following JP1 permissions:

- JP1_JPQ_Admin privileges
- JP1_JPQ_Operator privileges

Request format

Request line

```

POST /application/component/apiVersion/objects/execAgents/actions/changeStatus/invoke httpVersion

```

Message Body

```
{
  "parameters": {
    "manager": "manager-host-name-or-IP-address",
    "mode": "agent",
    "status": "job-transfer-restriction-status-of-execution-agent",
    "execAgents": ["execution-agent-name", ...]
  }
}
```

API version

v1

Information that uniquely identifies a resource

None

Parameter

The following table lists and describes the parameters that can be specified for `parameters` in the request message body.

Table 7–27: List of parameters for the API to change the job transfer restriction status of an execution agent

| Parameter | Data type | Description of the value | Required? |
|-------------------------|-----------|---|-----------|
| <code>manager</code> | string | Specify the manager host name or IP address by using a character string in the range from 1 to 255 bytes. | Y |
| <code>mode</code> | string | Specify a character string that indicates the target mode. Specify <code>agent</code> for this parameter. | Y |
| <code>status</code> | string | Specify the job transfer restriction status of an execution agent by using a character string constant that is supported by the <code>ExecAgentStatus</code> constant. For details about the <code>ExecAgentStatus</code> constant, see 7.4.14(1) ExecAgentStatus . | Y |
| <code>execAgents</code> | string[] | Specify the names of the execution agents as a string array. You can specify a maximum of 100 execution agents. Each execution agent name must be a character string in the range from 1 to 255 bytes. | Y |

Status code

The following table lists and describes the status codes returned as a response:

| Status code | Text description | Description |
|-------------|---------------------|--|
| 200 | OK | The job transfer restriction statuses of the execution agents were changed successfully. |
| 400 | Bad Request | The argument is invalid. |
| 401 | Unauthorized | Authentication is required. |
| 403 | Forbidden | The operator does not have execution permission. |
| 404 | Not found | The operator does not have access permission for the resource, or the resource does not exist. |
| 412 | Precondition failed | The Web Console server is not available. |
| 500 | Server-side error | A processing error occurred in the Web Console server. |

Response format

Response message body

```
{
  "results": [Execution-agent-operation-result-object]
}
```

Return values

If the status code is 200, the following information is returned:

| Member | Data type | Description |
|---------|-----------|--|
| results | object[] | Returns an array of the execution agent operation result objects. The number of array elements is the same as the number of elements in the array specified for the <code>execAgents</code> parameter. Also, if the command terminates abnormally on the manager host, a non-zero value is stored as the result code of the target processing and <code>KNAK3696-E</code> is stored as a message in the returned array. For details about the execution agent operation result object, see 7.3.6 Execution agent operation result object . |

Cautionary note

Even if an error has occurred in JP1/AJS3 - Web Console, the operation on the execution agent might be successful on the manager host.

Example

The following shows an example of using the API to change the job transfer restriction status of an execution agent.

Example request:

```
POST /ajs/api/v1/objects/execAgents/actions/changeStatus/invoke HTTP/1.1
Host: HOSTW:22252
Accept-Language: ja
Content-Type: application/json
X-AJS-Authorization: dXNlcjpwYXNzd29yZA==

{
  "parameters": {
    "manager": "HOSTM",
    "mode": "agent",
    "status": "HOLD",
    "execAgents": ["AGT01"]
  }
}
```

Example response (message body):

```
{
  "results": [
    {
      "rtnCode": "0",
      "output": null,
      "execAgent": "AGT01"
    }
  ]
}
```

7.1.28 Execution agent status change API

This API changes the status of an execution agent that is registered on the manager host. You can also specify multiple execution agents to change their statuses.

If the job distribution delay reduction function is enabled, you can change the statuses of execution agents. If the function is disabled, errors are returned for all execution agent operation results.

For details about job distribution delay reduction function, see *2.5.5 Considering reduction of job distribution delay in the JP1/Automatic Job Management System 3 System Design (Configuration) Guide*.

You can use this API function only if the version of JP1/AJS3 - Web Console is 12-50 or later and the version of the connection-destination JP1/AJS3 - Manager is 12-50 or later. Before you use this API function, confirm that: the return value (`productVersionNumber`) of the version information acquisition API function is 125000 or larger; and the return value (`protocolVersionNumber`) of the JP1/AJS3 - Manager protocol version acquisition API function is 1250 or larger.

Execution privileges

The logged-in JP1 user must have one of the following JP1 permissions:

- JP1_JPQ_Admin privileges
- JP1_JPQ_Operator privileges

Request format

Request line

```
POST /application/component/apiVersion/objects/execAgents/actions/changeComStatus/invoke httpVersion
```

Message Body

```
{
  "parameters": {
    "manager": "manager-host-name-or-IP-address",
    "comStatus": "execution-agent-status",
    "execAgents": ["execution-agent-name", ...]
  }
}
```

API version

v1

Information that uniquely identifies a resource

None

Parameter

The following table lists and describes the parameters that can be specified for `parameters` in the request message body.

Table 7–28: List of parameters for the Execution agent status change API

| Parameter | Data type | Description of the value | Required? |
|-----------|-----------|---|-----------|
| manager | string | Specify the manager host name or IP address by using a character string in the range from 1 to 255 bytes. | Y |

| Parameter | Data type | Description of the value | Required? |
|-----------|-----------|---|-----------|
| comStatus | string | Specify the status of an execution agent by using a character string constant that is supported by the ComStatus constant. For details about the ComStatus constant, see 7.4.14(2) ComStatus . | Y |
| execAgent | string[] | Specify the names of the execution agents as a string array. You can specify a maximum of 100 execution agents. Each execution agent name must be a character string in the range from 1 to 255 bytes. | Y |

Status code

The following table lists and describes the status codes returned as a response:

| Status code | Text description | Description |
|-------------|---------------------|--|
| 200 | OK | The statuses of execution agents were changed successfully. |
| 400 | Bad Request | The argument is invalid. |
| 401 | Unauthorized | Authentication is required. |
| 403 | Forbidden | The operator does not have execution permission. |
| 404 | Not found | The operator does not have access permission for the resource, or the resource does not exist. |
| 412 | Precondition failed | The Web Console server is not available. |
| 500 | Server-side error | A processing error occurred in the Web Console server. |

Response format

Response message body

```
{
  "results": [Execution-agent-operation-result-object]
}
```

Return values

If the status code is 200, the following information is returned:

| Member | Data type | Description |
|---------|-----------|--|
| results | object[] | Returns an array of the execution agent operation result objects. The number of array elements is the same as the number of elements in the array specified for the execAgents parameter. Also, if the command terminates abnormally on the manager host, a non-zero value is stored as the result code of the target processing and KNAK3696-E is stored as a message in the returned array. For details about the execution agent operation result object, see 7.3.6 Execution agent operation result object . |

Cautionary note

Even if an error has occurred in JP1/AJS3 - Web Console, the operation on the execution agent might be successful on the manager host.

Example

The following shows an example of using the API to change the status of an execution agent.

Example request:

```
POST /ajs/api/v1/objects/execAgents/actions/changeComStatus/invoke HTTP
/1.1
Host: HOSTW:22252
Accept-Language: ja
Content-Type: application/json
X-AJS-Authorization: dXNlcjpwYXNzd29yZA==

{
  "parameters":{
    "manager":"HOSTM",
    "comStatus":"UNAVAILABLE",
    "execAgents":["AGT01"]
  }
}
```

Example response (message body):

```
{
  "results":
  [
    {
      "rtnCode":"0",
      "output":null,
      "execAgent":"AGT01"
    }
  ]
}
```

7.1.29 API to check the communication status of the job distribution delay reduction function

This API checks the communication status of the job distribution delay reduction function on the manager host. Depending on the specified parameters, one of the following operations is performed:

- Start checking the communication status
- Stop checking the communication status
- Check the communication status

This API can be used to perform operations on execution agents only if the job distribution delay reduction function is enabled. If this function is disabled, all operations performed on execution agents by using this API result in an error.

For details about job distribution delay reduction function, see *2.5.5 Considering reduction of job distribution delay in the JPI/Automatic Job Management System 3 System Design (Configuration) Guide*.

You can use this API function only if the version of JPI/AJS3 - Web Console is 12-50 or later and the version of the connection-destination JPI/AJS3 - Manager is 12-50 or later. Before you use this API function, confirm that: the return value (`productVersionNumber`) of the version information acquisition API function is 125000 or larger; and the return value (`protocolVersionNumber`) of the JPI/AJS3 - Manager protocol version acquisition API function is 1250 or larger.

Execution privileges

The logged-in JP1 user must be mapped with an OS user who has the following administrator privileges:

- In Windows: Administrators privileges
- In UNIX: Superuser privileges

Request format

Request line

```
POST /application/component/apiVersion/objects/execAgents/actions/check/invoke httpVersion
```

Message Body

```
{
  "parameters":{
    "manager":"manager-host-name-or-IP-address",
    "action":"target-operation"
  }
}
```

API version

v1

Information that uniquely identifies a resource

None

Parameter

The following table lists and describes the parameters that can be specified for `parameters` in the request message body.

Table 7–29: List of parameters for the API to check the communication status of the job distribution delay reduction function

| Parameter | Data type | Description of the value | Required? |
|-----------|-----------|---|-----------|
| manager | string | Specify the manager host name or IP address by using a character string in the range from 1 to 255 bytes. | Y |
| action | string | Specify a character string that indicates the target operation. To start checking the communication status, specify <code>start</code> . To stop checking the communication status, specify <code>stop</code> . To check the communication status, specify <code>status</code> . | Y |

Status code

The following table lists and describes the status codes returned as a response:

| Status code | Text description | Description |
|-------------|------------------|---|
| 200 | OK | The communication status of the job distribution delay reduction function was checked successfully. |
| 400 | Bad Request | The argument is invalid. |
| 401 | Unauthorized | Authentication is required. |
| 403 | Forbidden | The operator does not have execution permission. |
| 404 | Not found | The operator does not have access permission for the resource, or the resource does not exist. |

| Status code | Text description | Description |
|-------------|---------------------|--|
| 412 | Precondition failed | The Web Console server is not available. |
| 500 | Server-side error | A processing error occurred in the Web Console server. |

Response format

Response message body

```
{
  "results": [Execution-agent-operation-result-object]
}
```

Return values

If the status code is 200, the following information is returned:

| Member | Data type | Description |
|---------|-----------|---|
| results | object[] | Returns an array of the execution agent operation result objects. In the returned array, the execution result is stored in element 0. For details about the execution agent operation result object, see 7.3.6 Execution agent operation result object . |

Cautionary note

Even if an error has occurred in JP1/AJS3 - Web Console, the operation on the execution agent might be successful on the manager host.

Example

The following shows an example of using the API to check the communication status of the job distribution delay reduction function.

Example request:

```
POST /ajs/api/v1/objects/execAgents/actions/check/invoke HTTP/1.1
Host: HOSTW:22252
Accept-Language: ja
Content-Type: application/json
X-AJS-Authorization: dXNlcjpwYXNzd29yZA==

{
  "parameters": {
    "manager": "HOSTM",
    "action": "start"
  }
}
```

Example response (message body):

```
{
  "results": [
    {
      "execAgent": "",
      "rtnCode": "0",
      "output": {
        "text": "KNAC1200-I Request for starting the communication status confirmation was issued to the agent monitoring process.",
        "serverTime": ""
      }
    }
  ]
}
```

```

        "statuses":null,
        "definitions":null
    }
]
}

```

7.1.30 Execution agent group status list acquisition API

This API acquires a list of the statuses of the execution agent groups that are registered on the manager host.

You can use this API function only if the version of JP1/AJS3 - Web Console is 12-50 or later and the version of the connection-destination JP1/AJS3 - Manager is 12-50 or later. Before you use this API function, confirm that: the return value (`productVersionNumber`) of the version information acquisition API function is 125000 or larger; and the return value (`protocolVersionNumber`) of the JP1/AJS3 - Manager protocol version acquisition API function is 1250 or larger.

Execution privileges

The logged-in JP1 user must have one of the following JP1 permissions:

- JP1_JPQ_Admin privileges
- JP1_JPQ_Operator privileges
- JP1_JPQ_User privileges

Request format

Request line

```
GET /application/component/apiVersion/objects/execAgents/statuses?query httpVersion
```

API version

v1

Information that uniquely identifies a resource

None

Parameter

The following table lists and describes the parameters that can be specified for `query`.

Table 7–30: List of parameters for the Execution agent group status list acquisition API

| Parameter | Description of the value | Required? |
|----------------------|--|-----------|
| <code>manager</code> | Specify the manager host name or IP address by using a character string in the range from 1 to 255 bytes. | Y |
| <code>mode</code> | Specify a character string that indicates the target mode. Specify <code>agentGroup</code> for this parameter. | Y |

Status code

The following table lists and describes the status codes returned as a response:

| Status code | Text description | Description |
|-------------|------------------|---|
| 200 | OK | A list of the statuses of execution agent groups was acquired successfully. |

| Status code | Text description | Description |
|-------------|---------------------|--|
| 400 | Bad Request | The query character string is invalid. |
| 401 | Unauthorized | Authentication is required. |
| 403 | Forbidden | The operator does not have execution permission. |
| 404 | Not found | The operator does not have access permission for the resource, or the resource does not exist. |
| 412 | Precondition failed | The Web Console server is not available. |
| 500 | Server-side error | A processing error occurred in the Web Console server. |

Response format

Response message body

```
{
  "results": [Execution-agent-operation-result-object]
}
```

Return values

If the status code is 200, the following information is returned:

| Member | Data type | Description |
|---------|-----------|--|
| results | object[] | Returns an array of the execution agent operation result objects. In the returned array, the result of acquiring the statuses of execution agent groups is stored in element 0. Also, if the command terminates abnormally on the manager host, a non-zero value is stored as the result code of the target processing and KNAK3696-E is stored as a message in the returned array. For details about the execution agent operation result object, see 7.3.6 Execution agent operation result object . |

Example

The following shows an example of using the API to acquire a status list of execution agent groups.

Example request:

```
GET /ajs/api/v1/objects/execAgents/statuses?manager=HOSTM&mode=agentGroup HTTP/1.1
Host: HOSTW:22252
Accept-Language: ja
X-AJS-Authorization: dXNlcjpwYXNzd29yZA==
```

Example response (message body):

```
{
  "results":
  [
    {
      "execAgent": "",
      "rtnCode": "0",
      "output":
      {
        "text": "",
        "serverTime": "2020-08-25T18:53:21+09:00",
        "statuses":
        [
```

```

    {
        "status": "EFFECTIVE",
        "description": "",
        "execAgent": "AGTG01",
        "linkAgents":
        [
            "AGT01:16",
            "AGT02:10"
        ],
        "que": 0
    },
    "definitions": null
}
]
}
}

```

7.1.31 Execution agent group definition acquisition API

This API acquires the definitions of the execution agent groups that are registered on the manager host.

You can use this API function only if the version of JP1/AJS3 - Web Console is 12-50 or later and the version of the connection-destination JP1/AJS3 - Manager is 12-50 or later. Before you use this API function, confirm that: the return value (`productVersionNumber`) of the version information acquisition API function is 125000 or larger; and the return value (`protocolVersionNumber`) of the JP1/AJS3 - Manager protocol version acquisition API function is 1250 or larger.

Execution privileges

The logged-in JP1 user must have one of the following JP1 permissions:

- JP1_JPQ_Admin privileges
- JP1_JPQ_Operator privileges
- JP1_JPQ_User privileges

Request format

Request line

```
GET /application/component/apiVersion/objects/execAgents/definitions?query httpVersion
```

API version

v1

Information that uniquely identifies a resource

None

Parameter

The following table lists and describes the parameters that can be specified for query.

Table 7–31: List of parameters for the Execution agent group definition acquisition API

| Parameter | Description of the value | Required? |
|-----------|---|-----------|
| manager | Specify the manager host name or IP address by using a character string in the range from 1 to 255 bytes. | Y |
| mode | Specify a character string that indicates the acquisition-target mode. Specify agentGroup for this parameter. | Y |
| execAgent | Specify the execution agent group name by using a character string in the range from 1 to 255 bytes. | Y |

Status code

The following table lists and describes the status codes returned as a response:

| Status code | Text description | Description |
|-------------|---------------------|--|
| 200 | OK | Execution agent group definitions were acquired successfully. |
| 400 | Bad Request | The query character string is invalid. |
| 401 | Unauthorized | Authentication is required. |
| 403 | Forbidden | The operator does not have execution permission. |
| 404 | Not found | The operator does not have access permission for the resource, or the resource does not exist. |
| 412 | Precondition failed | The Web Console server is not available. |
| 500 | Server-side error | A processing error occurred in the Web Console server. |

Response format

Response message body

```
{
  "results": [Execution-agent-operation-result-object]
}
```

Return values

If the status code is 200, the following information is returned:

| Member | Data type | Description |
|---------|-----------|---|
| results | object[] | Returns an array of the execution agent operation result objects. In the returned array, the result of acquiring execution agent group definitions is stored in element 0. Also, if the command terminates abnormally on the manager host, a non-zero value is stored as the result code of the target processing and KNAK3696-E is stored as a message in the returned array. For details about the execution agent operation result object, see 7.3.6 Execution agent operation result object . |

Example

The following shows an example of using the API to acquire the definitions of execution agent groups.

Example request:

```
GET /ajs/api/v1/objects/execAgents/definitions?manager=HOSTM&mode=agent
Group&execAgent=AGTG01 HTTP/1.1
Host: HOSTW:22252
```

```
Accept-Language: ja
X-AJS-Authorization: dXNlcjpwYXNzd29yZA==
```

Example response (message body):

```
{
  "results":
  [
    {
      "execAgent": "",
      "rtnCode": "0",
      "output":
      {
        "text": "",
        "serverTime": "",
        "statuses": null,
        "definitions":
        [
          {
            "status": "EFFECTIVE",
            "description": "",
            "execAgent": "AGTG01",
            "linkAgents":
            [
              "AGT01:16",
              "AGT02:10"
            ]
          }
        ]
      }
    }
  ]
}
```

7.1.32 Execution agent group addition API

This API adds an execution agent group to the manager host.

You can use this API function only if the version of JP1/AJS3 - Web Console is 12-50 or later and the version of the connection-destination JP1/AJS3 - Manager is 12-50 or later. Before you use this API function, confirm that: the return value (`productVersionNumber`) of the version information acquisition API function is 125000 or larger; and the return value (`protocolVersionNumber`) of the JP1/AJS3 - Manager protocol version acquisition API function is 1250 or larger.

Execution privileges

The logged-in JP1 user must have the following JP1 permission:

- JP1_JPQ_Admin privileges

Request format

Request line

```
POST /application/component/apiVersion/objects/execAgents httpVersion
```

Message Body

```
{
  "parameters":{
    "manager":"manager-host-name-or-IP-address",
    "mode":"target-mode",
    "execAgent":"execution-agent-group-name",
    "status":"job-transfer-restriction-status-of-execution-agent-group",
  },
  "description":"comment"
}
```

API version

v1

Information that uniquely identifies a resource

None

Parameter

The following table lists and describes the parameters that can be specified for `parameters` in the request message body.

Table 7–32: List of parameters for the Execution agent group addition API

| Parameter | Data type | Description of the value | Required? |
|--------------------------|-----------|---|-----------|
| <code>manager</code> | string | Specify the manager host name or IP address by using a character string in the range from 1 to 255 bytes. | Y |
| <code>mode</code> | string | Specify a character string that indicates the target mode. Specify <code>agentGroup</code> for this parameter. | Y |
| <code>execAgent</code> | string | Specify the execution agent group name by using a character string in the range from 1 to 255 bytes. | Y |
| <code>status</code> | string | Specify the job transfer restriction status of an execution agent group by using a character string constant that is supported by the <code>ExecAgentStatus</code> constant. For details about the <code>ExecAgentStatus</code> constant, see 7.4.14(1) ExecAgentStatus . If you do not want to specify the job transfer restriction status of an execution agent group, do not specify this parameter, alternatively, specify a null (zero-byte) string. | -- |
| <code>description</code> | string | Specify a description by using a character string of no more than 80 bytes. If you do not want to specify a description, do not specify this parameter, alternatively, specify a null (zero-byte) string. | -- |

Status code

The following table lists and describes the status codes returned as a response:

| Status code | Text description | Description |
|-------------|------------------|---|
| 200 | OK | The execution agent group was added successfully. |
| 400 | Bad Request | The argument is invalid. |
| 401 | Unauthorized | Authentication is required. |
| 403 | Forbidden | The operator does not have execution permission. |

| Status code | Text description | Description |
|-------------|---------------------|--|
| 404 | Not found | The operator does not have access permission for the resource, or the resource does not exist. |
| 412 | Precondition failed | The Web Console server is not available. |
| 500 | Server-side error | A processing error occurred in the Web Console server. |

Response format

Response message body

```
{
  "results": [Execution-agent-operation-result-object]
}
```

Return values

If the status code is 200, the following information is returned:

| Member | Data type | Description |
|---------|-----------|---|
| results | object[] | Returns an array of the execution agent operation result objects. In the returned array, the result of adding an execution agent group is stored in element 0. Also, if the command terminates abnormally on the manager host, a non-zero value is stored as the result code of the target processing and KNAK3696-E is stored as a message in the returned array. For details about the execution agent operation result object, see 7.3.6 Execution agent operation result object . |

Cautionary note

Even if an error has occurred in JP1/AJS3 - Web Console, the operation on the execution agent might be successful on the manager host.

Example

The following shows an example of using the API to add an execution agent group.

Example request:

```
POST /ajs/api/v1/objects/execAgents HTTP/1.1
Host: HOSTW:22252
Accept-Language: ja
Content-Type: application/json
X-AJS-Authorization: dXNlcjpwYXNzd29yZA==

{
  "parameters": {
    "manager": "HOSTM",
    "mode": "agentGroup",
    "execAgent": "AGTG01",
    "status": "BLOCKADE",
    "description": "test"
  }
}
```

Example response (message body):

```
{
  "results":
  [
```

```

    {
      "execAgent": "AGTG01",
      "rtnCode": "0",
      "output": null
    }
  ]
}

```

7.1.33 Execution agent group deletion API

This API deletes the specified execution agent group from the manager host. You can also delete multiple execution agent groups at one time.

You can use this API function only if the version of JP1/AJS3 - Web Console is 12-50 or later and the version of the connection-destination JP1/AJS3 - Manager is 12-50 or later. Before you use this API function, confirm that: the return value (`productVersionNumber`) of the version information acquisition API function is 125000 or larger; and the return value (`protocolVersionNumber`) of the JP1/AJS3 - Manager protocol version acquisition API function is 1250 or larger.

Execution privileges

The logged-in JP1 user must have the following JP1 permission:

- JP1_JPQ_Admin privileges

Request format

Request line

```
POST /application/component/apiVersion/objects/execAgents/actions/delete/invoke httpVersion
```

Message Body

```

{
  "parameters": {
    "manager": "manager-host-name-or-IP-address",
    "mode": "target-mode",
    "execAgents": ["execution-agent-group-name", ...]
  }
}

```

API version

v1

Information that uniquely identifies a resource

None

Parameter

The following table lists and describes the parameters that can be specified for `parameters` in the request message body.

Table 7–33: List of parameters for the Execution agent group deletion API

| Parameter | Data type | Description of the value | Required? |
|----------------------|-----------|---|-----------|
| <code>manager</code> | string | Specify the manager host name or IP address by using a character string in the range from 1 to 255 bytes. | Y |

| Parameter | Data type | Description of the value | Required? |
|------------|-----------|---|-----------|
| mode | string | Specify a character string that indicates the target mode. Specify <code>agentGroup</code> for this parameter. | Y |
| execAgents | string[] | Specify a string array of the names of the execution agent groups to be deleted. You can specify a maximum of 100 execution agent groups. Each execution agent group name must be a character string in the range from 1 to 255 bytes. | Y |

Status code

The following table lists and describes the status codes returned as a response:

| Status code | Text description | Description |
|-------------|---------------------|--|
| 200 | OK | The execution agent groups were deleted successfully. |
| 400 | Bad Request | The argument is invalid. |
| 401 | Unauthorized | Authentication is required. |
| 403 | Forbidden | The operator does not have execution permission. |
| 404 | Not found | The operator does not have access permission for the resource, or the resource does not exist. |
| 412 | Precondition failed | The Web Console server is not available. |
| 500 | Server-side error | A processing error occurred in the Web Console server. |

Response format

Response message body

```
{
  "results": [Execution-agent-operation-result-object, ...]
}
```

Return values

If the status code is 200, the following information is returned:

| Member | Data type | Description |
|---------|-----------|--|
| results | object[] | Returns an array of the execution agent operation result objects. The number of array elements is the same as the number of elements in the array specified for the <code>execAgents</code> parameter. Also, if the command terminates abnormally on the manager host, a non-zero value is stored as the result code of the target processing and <code>KNACK3696-E</code> is stored as a message in the returned array. For details about the execution agent operation result object, see 7.3.6 Execution agent operation result object . |

Cautionary note

Even if an error has occurred in JP1/AJS3 - Web Console, the operation on the execution agent might be successful on the manager host.

Example

The following shows an example of using the API to delete an execution agent group.

Example request:

```
POST /ajs/api/v1/objects/execAgents/actions/delete/invoke HTTP/1.1
Host: HOSTW:22252
```

```
Accept-Language: ja
Content-Type: application/json
X-AJS-Authorization: dXNlcjpwYXNzd29yZA==

{
  "parameters":{
    "manager":"HOSTM",
    "mode":"agentGroup",
    "execAgents":["AGTG01"]
  }
}
```

Example response (message body):

```
{
  "results":
  [
    {
      "execAgent":"AGTG01",
      "rtnCode":"0",
      "output":null
    }
  ]
}
```

7.1.34 Execution agent group reconfiguration API

This API changes the settings of an execution agent group that is set on the manager host.

You can use this API function only if the version of JP1/AJS3 - Web Console is 12-50 or later and the version of the connection-destination JP1/AJS3 - Manager is 12-50 or later. Before you use this API function, confirm that: the return value (`productVersionNumber`) of the version information acquisition API function is 125000 or larger; and the return value (`protocolVersionNumber`) of the JP1/AJS3 - Manager protocol version acquisition API function is 1250 or larger.

Execution privileges

The logged-in JP1 user must have the following JP1 permission:

- JP1_JPQ_Admin privileges

Request format

Request line

```
POST /application/component/apiVersion/objects/execAgents/actions/update/invoke httpVersion
```

Message Body

```
{
  "parameters":{
    "manager":"manager-host-name-or-IP-address",
    "mode":"target-mode",
    "execAgent":"execution-agent-group-name",
    "description":"comment"
  }
}
```

```

    }
}

```

API version

v1

Information that uniquely identifies a resource

None

Parameter

The following table lists and describes the parameters that can be specified for `parameters` in the request message body.

Table 7–34: List of parameters for the Execution agent group reconfiguration API

| Parameter | Data type | Description of the value | Required? |
|--------------------------|-----------|---|-----------|
| <code>manager</code> | string | Specify the manager host name or IP address by using a character string in the range from 1 to 255 bytes. | Y |
| <code>mode</code> | string | Specify a character string that indicates the target mode. Specify <code>agentGroup</code> for this parameter. | Y |
| <code>execAgent</code> | string | Specify the name of the execution agent whose settings are to be changed, by using a character string in the range from 1 to 255 bytes. | Y |
| <code>description</code> | string | Specify a description by using a character string of no more than 80 bytes. | Y |

Status code

The following table lists and describes the status codes returned as a response:

| Status code | Text description | Description |
|-------------|---------------------|--|
| 200 | OK | The settings of the execution agent group were changed successfully. |
| 400 | Bad Request | The argument is invalid. |
| 401 | Unauthorized | Authentication is required. |
| 403 | Forbidden | The operator does not have execution permission. |
| 404 | Not found | The operator does not have access permission for the resource, or the resource does not exist. |
| 412 | Precondition failed | The Web Console server is not available. |
| 500 | Server-side error | A processing error occurred in the Web Console server. |

Response format

Response message body

```

{
  "results": [Execution-agent-operation-result-object]
}

```

Return values

If the status code is 200, the following information is returned:

| Member | Data type | Description |
|---------|-----------|--|
| results | object[] | Returns an array of the execution agent operation result objects. In the returned array, the result of changing the execution agent group settings is stored in element 0. Also, if the command terminates abnormally on the manager host, a non-zero value is stored as the result code of the target processing and KNAK3 696-E is stored as a message in the returned array. For details about the execution agent operation result object, see 7.3.6 Execution agent operation result object . |

Cautionary note

Even if an error has occurred in JP1/AJS3 - Web Console, the operation on the execution agent might be successful on the manager host.

Example

The following shows an example of using the API to change the settings of an execution agent group.

Example request:

```
POST /ajs/api/v1/objects/execAgents/actions/update/invoke HTTP/1.1
Host: HOSTW:22252
Accept-Language: ja
Content-Type: application/json
X-AJS-Authorization: dXNlcjpwYXNzd29yZA==

{
  "parameters":{
    "manager":"HOSTM",
    "mode":"agentGroup",
    "execAgent":"AGTG01",
    "description":"TEST"
  }
}
```

Example response (message body):

```
{
  "results":
  [
    {
      "execAgent":"AGTG01",
      "rtnCode":"0",
      "output":null
    }
  ]
}
```

7.1.35 API to change the job transfer restriction status of an execution agent group

This API changes the job transfer restriction status of an execution agent group that is registered on the manager host. You can also specify multiple execution agent groups to change their job transfer restriction statuses.

You can use this API function only if the version of JP1/AJS3 - Web Console is 12-50 or later and the version of the connection-destination JP1/AJS3 - Manager is 12-50 or later. Before you use this API function, confirm that: the return

value (productVersionNumber) of the version information acquisition API function is 125000 or larger; and the return value (protocolVersionNumber) of the JP1/AJS3 - Manager protocol version acquisition API function is 1250 or larger.

Execution privileges

The logged-in JP1 user must have one of the following JP1 permissions:

- JP1_JPQ_Admin privileges
- JP1_JPQ_Operator privileges

Request format

Request line

```
POST /application/component/apiVersion/objects/execAgents/actions/changeStatus/invoke httpVersion
```

Message Body

```
{
  "parameters": {
    "manager": "manager-host-name-or-IP-address",
    "mode": "agentGroup",
    "status": "job-transfer-restriction-status-of-execution-agent-group"
  },
  "execAgents": ["execution-agent-group-name", ...]
}
```

API version

v1

Information that uniquely identifies a resource

None

Parameter

The following table lists and describes the parameters that can be specified for `parameters` in the request message body.

Table 7–35: List of parameters for the API to change the job transfer restriction status of an execution agent group

| Parameter | Data type | Description of the value | Required? |
|------------|-----------|---|-----------|
| manager | string | Specify the manager host name or IP address by using a character string in the range from 1 to 255 bytes. | Y |
| mode | string | Specify a character string that indicates the target mode. Specify <code>agentGroup</code> for this parameter. | Y |
| status | string | Specify the job transfer restriction status of an execution agent group by using a character string constant that is supported by the <code>ExecAgentStatus</code> constant. For details about the <code>ExecAgentStatus</code> constant, see 7.4.14(1) ExecAgentStatus . | Y |
| execAgents | string[] | Specify a string array of the execution agent group names. You can specify a maximum of 100 execution agent groups. Each execution agent group name must be a character string in the range from 1 to 255 bytes. | Y |

Status code

The following table lists and describes the status codes returned as a response:

| Status code | Text description | Description |
|-------------|---------------------|--|
| 200 | OK | The job transfer restriction statuses of execution agent groups were changed successfully. |
| 400 | Bad Request | The argument is invalid. |
| 401 | Unauthorized | Authentication is required. |
| 403 | Forbidden | The operator does not have execution permission. |
| 404 | Not found | The operator does not have access permission for the resource, or the resource does not exist. |
| 412 | Precondition failed | The Web Console server is not available. |
| 500 | Server-side error | A processing error occurred in the Web Console server. |

Response format

Response message body

```
{
  "results": [Execution-agent-operation-result-object]
}
```

Return values

If the status code is 200, the following information is returned:

| Member | Data type | Description |
|---------|-----------|---|
| results | object[] | Returns an array of the execution agent operation result objects. The number of array elements is the same as the number of elements in the array specified for the <code>execAgents</code> parameter. Also, if the command terminates abnormally on the manager host, a non-zero value is stored as the result code of the target processing and <code>KNAK3696-E</code> is stored as a message in the returned array. For details about the execution agent operation result object, see 7.3.6 Execution agent operation result object . |

Cautionary note

Even if an error has occurred in JP1/AJS3 - Web Console, the operation on the execution agent might be successful on the manager host.

Example

The following shows an example of using the API to change the job transfer restriction status of an execution agent group.

Example request:

```
POST /ajs/api/v1/objects/execAgents/actions/changeStatus/invoke HTTP/1.1
Host: HOSTW:22252
Accept-Language: ja
Content-Type: application/json
X-AJS-Authorization: dXNlcjpwYXNzd29yZA==

{
  "parameters": {
    "manager": "HOSTM",
```

```
    "mode": "agentGroup",
    "status": "HOLD",
    "execAgents": ["AGTG01"]
  }
}
```

Example response (message body):

```
{
  "results":
  [
    {
      "execAgent": "AGTG01",
      "rtnCode": "0",
      "output": null
    }
  ]
}
```

7.1.36 API to exclude or add execution agents, or to change their priority levels

This API excludes or adds execution agents for an execution agent group that is registered on the manager host. The API also changes the priority levels of such execution agents.

You can use this API function only if the version of JP1/AJS3 - Web Console is 12-50 or later and the version of the connection-destination JP1/AJS3 - Manager is 12-50 or later. Before you use this API function, confirm that: the return value (`productVersionNumber`) of the version information acquisition API function is 125000 or larger; and the return value (`protocolVersionNumber`) of the JP1/AJS3 - Manager protocol version acquisition API function is 1250 or larger.

Execution privileges

The logged-in JP1 user must have the following JP1 permission:

- JP1_JPQ_Admin privileges

Request format

Request line

```
POST /application/component/apiVersion/objects/execAgents/actions/changeLinkAgent/invoke httpVersion
```

Request message body

```
{
  "parameters": {
    "manager": "manager-host-name-or-IP-address",
    "execAgentGroup": "execution-agent-group-name",
    "action": "target-operation",
    "execAgent": "execution-agent-name",
    "priority": priority
  }
}
```

API version

v1

Information that uniquely identifies a resource

None

Parameter

The following table lists and describes the parameters that can be specified for `parameters` in the request message body.

Table 7–36: List of parameters for the API to exclude or add execution agents, or to change their priority levels

| Parameter | Data type | Description of the value | Required? |
|-----------------------------|-----------|--|-----------|
| <code>manager</code> | string | Specify the manager host name or IP address by using a character string in the range from 1 to 255 bytes. | Y |
| <code>execAgentGroup</code> | string | Specify the name of the execution agent group. Specify a character string in the range from 1 to 255 bytes. | Y |
| <code>action</code> | string | Specify a character string to indicate the target operation. To exclude an execution agent, specify <code>remove</code> . To add an execution agent, specify <code>add</code> . To change the priority level of an execution agent, specify <code>changePriority</code> . | Y |
| <code>execAgent</code> | string | Specify the name of the execution agent that is to be excluded or added or whose priority level is to be changed, by using a character string in the range from 1 to 255 bytes. Each execution agent group name must be a character string in the range from 1 to 255 bytes. | Y |
| <code>priority</code> | int | Specify the priority by using a numeric value in the range from 1 to 16. Do not specify this parameter if you specify <code>remove</code> for the <code>action</code> parameter or if you do not want to specify the priority. | -- |

Status code

The following table lists and describes the status codes returned as a response:

| Status code | Text description | Description |
|-------------|---------------------|---|
| 200 | OK | An execution agent was excluded or added successfully, or the priority level of the execution agent was changed successfully. |
| 400 | Bad Request | The argument is invalid. |
| 401 | Unauthorized | Authentication is required. |
| 403 | Forbidden | The operator does not have execution permission. |
| 404 | Not found | The operator does not have access permission for the resource, or the resource does not exist. |
| 412 | Precondition failed | The Web Console server is not available. |
| 500 | Server-side error | A processing error occurred in the Web Console server. |

Response format

Response message body

```
{
  "results": [Execution-agent-operation-result-object]
}
```

Return values

If the status code is 200, the following information is returned:

| Member | Data type | Description |
|---------|-----------|--|
| results | object[] | Returns an array of the execution agent operation result objects. In the returned array, the operation result is stored in element 0. Also, if the command terminates abnormally on the manager host, a non-zero value is stored as the result code of the target processing and KNAK3696-E is stored as a message in the returned array. For details about the execution agent operation result object, see 7.3.6 Execution agent operation result object . |

Cautionary note

Even if an error has occurred in JP1/AJS3 - Web Console, the operation on the execution agent might be successful on the manager host.

Example

The following shows an example of using the API to add an execution agent to the specified execution agent group.

Example request:

```
POST /ajs/api/v1/objects/execAgents/actions/changeLinkAgent/invoke HTTP
/1.1
Host: HOSTW:22252
Accept-Language: ja
Content-Type: application/json
X-AJS-Authorization: dXNlcjpwYXNzd29yZA==

{
  "parameters":{
    "manager":"HOSTM",
    "execAgentGroup":"AGTG01",
    "action":"add",
    "execAgent":"AGT03",
    "priority":1
  }
}
```

Example response (message body):

```
{
  "results":
  [
    {
      "execAgent":"AGTG01",
      "rtnCode":"0",
      "output":null
    }
  ]
}
```

7.1.37 Version information acquisition API

This API acquires product version information.

Use this API to determine the product version of JP1/AJS3 - Web Console when you specify the APIs or parameters in the list below. For details, see the description of the relevant API or parameter.

| API or parameter | Relevant section |
|--|---|
| The following parameter of the unit list acquisition API: <ul style="list-style-type: none"> periodBegin periodEnd | <i>7.1.1 Unit list acquisition API</i> |
| Unit information acquisition API | <i>7.1.2 Unit information acquisition API</i> |
| The following parameter of the unit information acquisition API: <ul style="list-style-type: none"> searchConnectInfo | |
| Wait condition status list acquisition API | <i>7.1.4 Wait condition status list acquisition API</i> |
| The following parameter of the planned execution registration API: <ul style="list-style-type: none"> holding | <i>7.1.5 Planned execution registration API</i> |
| The following parameters of the fixed execution registration API: <ul style="list-style-type: none"> holding startTime passedDaemonStarts fixedScheduleFrom fixedScheduleTo | <i>7.1.6 Fixed execution registration API</i> |
| The following parameters of the registration cancellation API: <ul style="list-style-type: none"> begin end | <i>7.1.8 Registration cancellation API</i> |
| Change delay monitor API | <i>7.1.10 Change delay monitor API</i> |
| Change job status API | <i>7.1.11 Change job status API</i> |
| Change plan (change time) API | <i>7.1.12 Change plan (change time) API</i> |
| The following parameters of the change plan (change time) API: <ul style="list-style-type: none"> absoluteTime | |
| Change plan (execute immediately) API | <i>7.1.13 Change plan (execute immediately) API</i> |
| Change plan (execution prohibited) API | <i>7.1.14 Change plan (execution prohibited) API</i> |
| Change plan (release change) API | <i>7.1.15 Change plan (release change) API</i> |
| Interrupt API | <i>7.1.16 Interrupt API</i> |
| Kill API | <i>7.1.17 Kill API</i> |
| Rerun API | <i>7.1.18 Rerun API</i> |
| Wait status change API | <i>7.1.19 Wait status change API</i> |
| Execution order control method change API | <i>7.1.20 Execution order control method change API</i> |

| API or parameter | Relevant section |
|--|--|
| Execution agent status list acquisition API | <i>7.1.21 Execution agent status list acquisition API</i> |
| Execution agent status acquisition API | <i>7.1.22 Execution agent status acquisition API</i> |
| Execution agent definition acquisition API | <i>7.1.23 Execution agent definition acquisition API</i> |
| Execution agent addition API | <i>7.1.24 Execution agent addition API</i> |
| Execution agent deletion API | <i>7.1.25 Execution agent deletion API</i> |
| Execution agent reconfiguration API | <i>7.1.26 Execution agent reconfiguration API</i> |
| API to change the job transfer restriction status of an execution agent | <i>7.1.27 API to change the job transfer restriction status of an execution agent</i> |
| Execution agent status change API | <i>7.1.28 Execution agent status change API</i> |
| API to check the communication status of the job distribution delay reduction function | <i>7.1.29 API to check the communication status of the job distribution delay reduction function</i> |
| Execution agent group status list acquisition API | <i>7.1.30 Execution agent group status list acquisition API</i> |
| Execution agent group definition acquisition API | <i>7.1.31 Execution agent group definition acquisition API</i> |
| Execution agent group addition API | <i>7.1.32 Execution agent group addition API</i> |
| Execution agent group deletion API | <i>7.1.33 Execution agent group deletion API</i> |
| Execution agent group reconfiguration API | <i>7.1.34 Execution agent group reconfiguration API</i> |
| API to change the job transfer restriction status of an execution agent group | <i>7.1.35 API to change the job transfer restriction status of an execution agent group</i> |
| API to exclude or add execution agents, or to change their priority levels | <i>7.1.36 API to exclude or add execution agents, or to change their priority levels</i> |
| JP1/AJS3 - Manager protocol version acquisition API | <i>7.1.38 JP1/AJS3 - Manager protocol version acquisition API</i> |

Execution privileges

None

Request format

Request line

```
GET /application/component/apiVersion/version?query httpVersion
```

API version

v1

Information that uniquely identifies a resource

None

Parameter

The following table lists and describes the parameters that can be specified for query.

Table 7–37: List of parameters for the version information acquisition API

| Parameter | Description of the value | Required? |
|-----------|---|-----------|
| manager | Specify the manager host name or IP address by using a character string in the range from 1 to 255 bytes. | Y |

Legend:

Y: Required

Status code

The following table lists and describes the status codes returned as a response:

| Status code | Text description | Description |
|-------------|---------------------|--|
| 200 | OK | Version information was successfully acquired. |
| 400 | Bad Request | The query character string is invalid. |
| 401 | Unauthorized | Authentication is required. |
| 404 | Not found | The operator does not have access permission for the resource, or the resource does not exist. |
| 412 | Precondition failed | The Web Console server is not available. |
| 500 | Server-side error | A processing error occurred in the Web Console server. |

Response format

Response message body

```
{
  "productName": "product-name",
  "productVersion": "product-version",
  "displayProductVersion": "product-version (for-display)",
  "productVersionNumber": product-version (number)
}
```

Return values

If the status code is 200, the following information is returned:

| Member | Data type | Description |
|-----------------------|-----------|--|
| productName | string | Returns the product name. |
| productVersion | string | Returns the product version in the format of <i>VV-RR-SS</i> . <i>VV</i> , <i>RR</i> , and <i>SS</i> each indicate a two-digit number. |
| displayProductVersion | string | Returns the product version (for display) in the format of <i>VV-RR</i> or <i>VV-RR-SS</i> . <i>VV</i> , <i>RR</i> , and <i>SS</i> each indicate a two-digit number. For example, if the value of <code>productVersion</code> is 11-00-00, 11-00 is returned with a value for <i>SS</i> omitted. |
| productVersionNumber | int | Returns the product version as a number. The returned number is in the format of <i>VVRRSS</i> for the product version <i>VV-RR-SS</i> . For example, if the product version is 11-00-06, 110006 is returned. If the product version is 11-10-00, 111000 is returned. This member is returned if the version of JP1/AJS3 - Web Console is 11-10 or later. If this member is not returned, assume that the version of JP1/AJS3 - Web Console is earlier than 11-10. |

Example

The following shows an example of using the API that acquires version information of the product.

Example request:

```
GET /ajs/api/v1/version?manager=HOSTM HTTP/1.1
Host: HOSTW:22252
Accept-Language: ja
X-AJS-Authorization: dXNlcjpwYXNzd29yZA==
```

Example response (message body):

```
{
  "productName": "Automatic Job Management System 3 - Web Console",
  "productVersion": "11-10-00",
  "displayProductVersion": "11-10",
  "productVersionNumber": 111000
}
```

7.1.38 JP1/AJS3 - Manager protocol version acquisition API

This API acquires the protocol version of connection-destination JP1/AJS3 - Manager.

A protocol version is a value that indicates the version of the communication interface for connection-destination JP1/AJS3 - Manager.

Use this API to determine the protocol version of connection-destination JP1/AJS3 - Manager when you specify the API or parameter in the table below. For details, see the description of the API or parameter.

| API or parameter | Relevant section |
|---|--|
| The following parameter of the unit list acquisition API: <ul style="list-style-type: none">• <code>periodBegin</code>• <code>periodEnd</code> | 7.1.1 Unit list acquisition API |
| The following parameter of the planned execution registration API: <ul style="list-style-type: none">• <code>holding</code> | 7.1.5 Planned execution registration API |
| The following parameters of the fixed execution registration API: <ul style="list-style-type: none">• <code>holding</code>• <code>passedDaemonStarts</code>• <code>fixedScheduleFrom</code>• <code>fixedScheduleTo</code>• <code>startTime</code> | 7.1.6 Fixed execution registration API |
| The following parameters of the registration cancellation API: <ul style="list-style-type: none">• <code>begin</code>• <code>end</code> | 7.1.8 Registration cancellation API |
| The following parameters of the change plan (change time) API: <ul style="list-style-type: none">• <code>absoluteTime</code> | 7.1.12 Change plan (change time) API |
| Execution agent status list acquisition API | 7.1.21 Execution agent status list acquisition API |
| Execution agent status acquisition API | 7.1.22 Execution agent status acquisition API |

| API or parameter | Relevant section |
|--|--|
| Execution agent definition acquisition API | <i>7.1.23 Execution agent definition acquisition API</i> |
| Execution agent addition API | <i>7.1.24 Execution agent addition API</i> |
| Execution agent deletion API | <i>7.1.25 Execution agent deletion API</i> |
| Execution agent reconfiguration API | <i>7.1.26 Execution agent reconfiguration API</i> |
| API to change the job transfer restriction status of an execution agent | <i>7.1.27 API to change the job transfer restriction status of an execution agent</i> |
| Execution agent status change API | <i>7.1.28 Execution agent status change API</i> |
| API to check the communication status of the job distribution delay reduction function | <i>7.1.29 API to check the communication status of the job distribution delay reduction function</i> |
| Execution agent group status list acquisition API | <i>7.1.30 Execution agent group status list acquisition API</i> |
| Execution agent group definition acquisition API | <i>7.1.31 Execution agent group definition acquisition API</i> |
| Execution agent group addition API | <i>7.1.32 Execution agent group addition API</i> |
| Execution agent group deletion API | <i>7.1.33 Execution agent group deletion API</i> |
| Execution agent group reconfiguration API | <i>7.1.34 Execution agent group reconfiguration API</i> |
| API to change the job transfer restriction status of an execution agent group | <i>7.1.35 API to change the job transfer restriction status of an execution agent group</i> |
| API to exclude or add execution agents, or to change their priority levels | <i>7.1.36 API to exclude or add execution agents, or to change their priority levels</i> |

You can use this API only when the JP1/AJS3 - Web Console version is 11-10 or later. Before using this API, make sure that the return value of the version information acquisition API (`productVersionNumber`) is 111000 or greater.

Execution privileges

None

Request format

Request line

```
GET /application/component/apiVersion/protocolVersion?query httpVersion
```

API version

v1

Information that uniquely identifies a resource

None

Parameter

The following table lists and describes the parameters that can be specified for `query`.

Table 7–38: List of parameters for the JP1/AJS3 - Manager protocol version acquisition API

| Parameter | Data type | Description of the value | Required? |
|----------------------|-----------|---|-----------|
| <code>manager</code> | string | Specify the manager host name or IP address by using a character string in the range from 1 to 255 bytes. | Y |

Legend:

Y: Required

Status code

The following table lists and describes the status codes returned as a response:

| Status code | Text description | Description |
|-------------|---------------------|--|
| 200 | OK | The protocol version of connection-destination JP1/AJS3 - Manager was acquired successfully. |
| 400 | Bad Request | The query character string is invalid. |
| 401 | Unauthorized | Authentication is required. |
| 404 | Not found | The operator does not have access permission for the resource, or the resource does not exist. |
| 412 | Precondition failed | The Web Console server is not available. |
| 500 | Server-side error | A processing error occurred in the Web Console server. |

Response format

Response message body

```
{
  "protocolVersionNumber":protocol-version-of-connection-destination-JP1/AJS3 - Manager
}
```

Return values

If the status code is 200, the following information is returned:

| Member | Data type | Description |
|-----------------------|-----------|--|
| protocolVersionNumber | int | Returns a number indicating the protocol version of connection-destination JP1/AJS3 - Manager. |

Example

The following shows an example of using the API that acquires the protocol version of connection-destination JP1/AJS3 - Manager.

Example request:

```
GET /ajs/api/v1/protocolVersion?manager=HOSTM HTTP/1.1
Host: HOSTW:22252
Accept-Language: ja
X-AJS-Authorization: dXNlcjpwYXNzd29yZA==
```

Example response (message body):

```
{
  "protocolVersionNumber":1110
}
```

7.2 Details of resources

This section describes the formats and details of the individual resources released for JPI/AJS3.

7.2.1 Resource for status monitoring

The following shows the details of the resource for status monitoring.

For details about whether the API can acquire the status monitoring resource, see [D.1 List of members of the status monitoring resource that can be acquired by the API](#).

Format

```
{
  "definition": unit-definition-information-object,
  "unitStatus": status-information-object,
  "release": release-information-object
}
```

Member

The following table lists and describes the members to be returned.

Table 7–39: List of members of the resource for status monitoring

| Member | Data type | Description |
|------------|-----------|--|
| definition | object | Returns the unit definition information object. For details about the unit definition information object, see 7.3.1 Unit definition information object . |
| unitStatus | object | Returns the status information object. For details about the status information object, see 7.3.2 Status information object . If information cannot be acquired, or if there is no generation to be acquired, <code>null</code> is returned. |
| release | object | Returns the release information object. For details about the release information object, see 7.3.3 Release information object . In the following cases, <code>null</code> is returned: <ul style="list-style-type: none">• When information cannot be acquired• When the unit does not have information• When the unit is neither a unit of the release-destination jobnet nor under that jobnet |

7.2.2 Wait resource

The following shows the details of the wait resource.

Format

```
{
  "unitName": "full-name-of-unit-with-wait-conditions",
  "unitComment": "comment-on-unit-with-wait-conditions",
  "status": "status-of-unit-with-wait-conditions",
  "execId": "execution-ID-of-unit-with-wait-conditions",
  "startDelayStatus": "whether-to-delay-start-of-unit-with-wait-conditions"
}
```

```

",
  "nestStartDelayStatus": "whether-to-delay-start-of-units-subordinate-to-unit-with-wait-conditions",
  "endDelayStatus": "whether-to-delay-end-of-unit-with-wait-conditions",
  "nestEndDelayStatus": "whether-to-delay-end-of-units-subordinate-to-unit-with-wait-conditions",
  "waitMethod": "waiting-method",
  "noGenerationAction": "[No_generations_to_wait_for]-setting",
  "unmonitoredEndedAction": "[When_Unmonitored_+_Ended]-setting",
  "abnomalEndedAction": "[Abnormal_end_for_an_execution_generation]-setting",
",
  "waitingTargetUnits": [
    {
      "unitName": "full-name-of-unit-being-waited-for",
      "unitComment": "comment-on-waiting-target-unit",
      "status": "status-of-waiting-target-unit",
      "execId": "execution-ID-of-waiting-target-unit",
      "startDelayStatus": "whether-to-delay-start-of-waiting-target-unit",
      "nestStartDelayStatus": "whether-to-delay-start-of-units-subordinate-to-waiting-target-unit",
      "endDelayStatus": "whether-to-delay-end-of-waiting-target-unit",
      "nestEndDelayStatus": "whether-to-delay-end-of-units-subordinate-to-waiting-target-unit",
      "waitStatus": "wait-status-of-waiting-target-unit",
    }, ...
  ]
}

```

Member

The following table lists and describes the members to be returned.

Table 7–40: List of members of the wait resource

| Member | Data type | Description |
|------------------|-----------|---|
| unitName | string | Returns the full name of a unit with wait conditions by using a character string in the range from 1 to 930 bytes. If information cannot be acquired, a character string of 0 bytes is returned. |
| unitComment | string | Returns the comment on a unit with wait conditions by using a character string of no more than 80 bytes. If no information can be acquired or no comment is defined for the unit, a character string of 0 bytes is returned. |
| status | string | Returns the status of a unit with wait conditions by using a character string constant that is supported by the <code>Status</code> constant. If information cannot be acquired, <code>NONE</code> (not applicable) is returned. For details about the <code>Status</code> constant, see 7.4.1(2) Status . |
| execId | string | Returns the execution ID of a unit with wait conditions by using a character string in the format of <code>@[mmmm]{A to Z}nnnn</code> (for example, <code>@10A200</code>). If information cannot be acquired, a character string of 0 bytes is returned. |
| startDelayStatus | string | Returns whether to delay the start of a unit with wait conditions, by using a character string constant that is supported by the <code>DelayStart</code> constant. |

| Member | Data type | Description |
|------------------------|-----------|---|
| startDelayStatus | string | If information cannot be acquired, NONE (not applicable) is returned. For details about the DelayStart constant, see 7.4.1(3) DelayStart . |
| nestStartDelayStatus | string | Returns whether to delay the start of the units subordinate to a unit with wait conditions, by using a character string constant that is supported by the DelayStart constant. If information cannot be acquired, NONE (not applicable) is returned. For details about the DelayStart constant, see 7.4.1(3) DelayStart . |
| endDelayStatus | string | Returns whether to delay the end of a unit with wait conditions, by using a character string constant that is supported by the DelayEnd constant. If information cannot be acquired, NONE (not applicable) is returned. For details about the DelayEnd constant, see 7.4.1(4) DelayEnd . |
| nestEndDelayStatus | string | Returns whether to delay the end of the units subordinate to a unit with wait conditions, by using a character string constant that is supported by the DelayEnd constant. If information cannot be acquired, NONE (not applicable) is returned. For details about the DelayEnd constant, see 7.4.1(4) DelayEnd . |
| waitMethod | string | Returns the wait method for the wait conditions set for a unit with wait conditions, by using a character string constant that is supported by the WaitMethod constant. For details about the WaitMethod constant, see 7.4.13(1) WaitMethod . |
| noGenerationAction | string | Returns the action selected for the No generations to wait for setting in the wait conditions set for a unit with wait conditions, by using a character string that is supported by the WaitingAction constant. For details about the WaitingAction constant, see 7.4.13(2) WaitingAction . |
| unmonitoredEndedAction | string | Returns the action selected for the When Unmonitored + Ended setting in the wait conditions set for a unit with wait conditions, by using a character string that is supported by the WaitingAction constant. For details about the WaitingAction constant, see 7.4.13(2) WaitingAction . |
| abnomalEndedAction | string | Returns the action selected for the Abnormal end for an execution generation setting in the wait conditions set for a unit with wait conditions, by using a character string that is supported by the WaitingAction constant. For details about the WaitingAction constant, see 7.4.13(2) WaitingAction . |
| waitingTargetUnits | object[] | Returns an object array of the waiting-target units that are set in the wait conditions set for a unit with wait conditions. |
| unitName | string | Returns the full name of a waiting-target unit set in the wait conditions of a unit with wait conditions, by using a character string in the range from 1 to 930 bytes. If information cannot be acquired, a character string of 0 bytes is returned. |

| Member | Data type | Description |
|-----------------------------------|-----------|--|
| <code>unitComment</code> | string | Returns the comment on a waiting-target unit set in the wait conditions of a unit with wait conditions, by using a character string of no more than 80 bytes. If no information can be acquired or no comment is defined for the unit, a character string of 0 bytes is returned. |
| <code>status</code> | string | Returns the status of a waiting-target unit set in the wait conditions of a unit with wait conditions, by using a character string constant that is supported by the <code>Status</code> constant. For the following cases, <code>NONE</code> (not applicable) is returned: <ul style="list-style-type: none"> • If information cannot be acquired • If the unit whose end is being waited for is a planning group For details about the <code>Status</code> constant, see 7.4.1(2) Status . |
| <code>execId</code> | string | Returns the execution ID of a waiting-target unit set in the wait conditions of a unit with wait conditions, by using a character string in the format of <code>@[mmmm]{A to Z}nnnn</code> (for example, <code>@10A200</code>). For the following cases, a character string of 0 bytes is returned: <ul style="list-style-type: none"> • If information cannot be acquired • If the unit whose end is being waited for is a planning group |
| <code>startDelayStatus</code> | string | Returns whether to delay the start of a waiting-target unit set in the wait conditions of a unit with wait conditions, by using a character string constant that is supported by the <code>DelayStart</code> constant. For the following cases, <code>NONE</code> (not applicable) is returned: <ul style="list-style-type: none"> • If information cannot be acquired • If the unit whose end is being waited for is a planning group For details about the <code>DelayStart</code> constant, see 7.4.1(3) DelayStart . |
| <code>nestStartDelayStatus</code> | string | Returns whether to delay the start of the units subordinate to a waiting-target unit set in the wait conditions of a unit with wait conditions, by using a character string constant that is supported by the <code>DelayStart</code> constant. For the following cases, <code>NONE</code> (not applicable) is returned: <ul style="list-style-type: none"> • If information cannot be acquired • If the unit whose end is being waited for is a planning group For details about the <code>DelayStart</code> constant, see 7.4.1(3) DelayStart . |
| <code>endDelayStatus</code> | string | Returns whether to delay the end of a waiting-target unit set in the wait conditions of a unit with wait conditions, by using a character string constant that is supported by the <code>DelayEnd</code> constant. For the following cases, <code>NONE</code> (not applicable) is returned: <ul style="list-style-type: none"> • If information cannot be acquired • If the unit whose end is being waited for is a planning group For details about the <code>DelayEnd</code> constant, see 7.4.1(4) DelayEnd . |

| Member | Data type | Description |
|--------------------|-----------|--|
| nestEndDelayStatus | string | <p>Returns whether to delay the end of the units subordinate to a waiting-target unit set in the wait conditions of a unit with wait conditions, by using a character string constant that is supported by the <code>DelayEnd</code> constant.</p> <p>For the following cases, NONE (not applicable) is returned:</p> <ul style="list-style-type: none"> • If information cannot be acquired • If the unit whose end is being waited for is a planning group <p>For details about the <code>DelayEnd</code> constant, see 7.4.1(4) DelayEnd.</p> |
| waitingStatus | string | <p>Returns the status of waiting with a waiting-target unit set in the wait conditions of a unit with wait conditions, by using a character string constant that is supported by the <code>WaitingStatus</code> constant.</p> <p>For details about the <code>WaitingStatus</code> constant, see 7.4.13(2) WaitingAction.</p> |

7.3 Details of objects

This section describes the formats and details of the individual objects released for APIs.

7.3.1 Unit definition information object

This object indicates unit definition information.

For details about whether the API can acquire the unit definition information object, see [D.2 List of members of the unit definition information object that can be acquired by the API](#).

Format

```
{
  "unitName": "unit-full-path-name",
  "unitComment": "comment-of-the-unit",
  "unitType": "unit-type",
  "owner": "Owner",
  "execAgent": "execution-agent-name",
  "execFileName": "execution-file-name-or-script-file-name",
  "parameters": "Parameter",
  "customJobType": "custom-job-type",
  "customEventJobType": "custom-event-job-type",
  "registerStatus": "registration-status-of-the-unit",
  "recoveryUnit": "whether-the-unit-is-a-recovery-unit",
  "unitID": "unit-ID",
  "wait": "whether-the-unit-is-a-unit-with-wait-condition",
  "jobnetReleaseUnit": "whether-release-entry-has-been-performed-for-the-unit",
  "jplResourceGroup": "JPl-resource-group-name",
  "simpleUnitName": "unit-name",
  "rootJobnetName": "full-name-of-the-unit-of-the-root-jobnet"
}
```

Member

The following table lists and describes the members to be returned.

Table 7–41: List of members of the unit definition information object

| Member | Data type | Description |
|-------------|-----------|--|
| unitName | string | Returns the full name of the unit, by using a character string in the range from 1 to 930 bytes. If information cannot be acquired, a character string of 0 bytes is returned. |
| unitComment | string | Returns the comment for the unit, by using a character string in the range from 0 to 80 bytes. If information cannot be acquired, or if no comment is defined for the unit, a character string of 0 bytes is returned. |
| unitType | string | Returns the unit type, by using a character string constant specified for the Type constant. For details about the Type constant, see 7.4.4(1) Type . If information cannot be acquired, NONE (not applicable) is returned. |
| owner | string | Returns the owner name defined for the unit, by using a character string in the range from 0 to 31 bytes. If information cannot be |

| Member | Data type | Description |
|--------------------|-----------|---|
| owner | string | acquired, or if no owner name is defined for the unit, a character string of 0 bytes is returned. |
| execAgent | string | Returns the execution agent (execution agent name or execution agent group name) defined for the unit, by using a character string in the range from 0 to 255 bytes. If information cannot be acquired, or if no execution agent is defined for the unit, a character string of 0 bytes is returned. |
| execFileName | string | Returns the execution file name or script file name that is defined for the unit, by using a character string in the range from 0 to 511 bytes. In the following cases, a character string of 0 bytes is returned: <ul style="list-style-type: none"> • When information cannot be acquired • When no execution file name or no script file name is defined • When the unit is other than the Unix job, PC job, flexible job, and QUEUE job |
| parameters | string | Returns the parameter defined for the PC job, Unix job, flexible job, or QUEUE job, by using a character string in the range from 0 to 1,023 bytes. In the following cases, a character string of 0 bytes is returned: <ul style="list-style-type: none"> • When information cannot be acquired • When no parameter is defined • When the unit is other than the Unix job, PC job, flexible job, and QUEUE job |
| customJobType | string | Returns the type of the custom job by using a character string when the value of the unitType member is CUSTOM (custom job). For details about the list of custom job types, see Table 7-42 . If information cannot be acquired, or if the value of the unitType member is not CUSTOM, a character string of 0 bytes is returned. |
| customEventJobType | string | Returns the type of the custom event job by using a character string when the value of the unitType member is EVCUSTOM (custom event job). For details about the list of custom event job types, see Table 7-43 . If information cannot be acquired, or if the value of the unitType member is not EVCUSTOM, a character string of 0 bytes is returned. |
| registerStatus | string | Returns the execution registration status of the unit, by using a character string constant specified for the RegisterStatus constant. For details about the RegisterStatus constant, see 7.4.4(2) RegisterStatus . If information cannot be acquired, NONE (not applicable) is returned. |
| recoveryUnit | boolean | Returns whether the recovery attribute is set for the unit. If the recovery attribute is set for the unit, true is returned. If information cannot be acquired, or if no recovery attribute is set for the unit, false is returned. |
| unitID | int | Returns the unit ID in number. If information cannot be acquired, -1 is returned. |
| wait | boolean | Returns whether the unit is a unit with wait condition. If the unit is a unit with wait condition, true is returned. If information cannot be acquired, or if the unit is not a unit with wait condition, false is returned. |
| jobnetReleaseUnit | boolean | Returns whether release entry has been performed for the unit. |

| Member | Data type | Description |
|-------------------|-----------|---|
| jobnetReleaseUnit | boolean | If release entry has been performed for the unit, true is returned. If information cannot be acquired or if release entry has not been performed for the unit, false is returned. |
| jp1ResourceGroup | string | Returns the JP1 resource group name defined for the unit, by using a character string in the range from 0 to 63 bytes. If information cannot be acquired, or if no JP1 resource group is defined for the unit, a character string of 0 bytes is returned. |
| simpleUnitName | string | Returns the unit name, by using a character string in the range from 1 to 30 bytes. If information cannot be acquired, a character string of 0 bytes is returned. |
| rootJobnetName | string | Returns the full name of the unit of the root jobnet, by using a character string in the range from 1 to 930 bytes. If information cannot be acquired, a character string of 0 bytes is returned. |

Table 7–42: List of custom job types

| Category | Description |
|---------------------|-----------------------|
| Standard Custom Job | CUSTOM_PC_ADSHPC |
| | CUSTOM_PC_ADSHAPPEXEC |
| | CUSTOM_PC_ADSHUX |
| | CUSTOM_PC_COSMNGAP |
| | CUSTOM_PC_COSMNGSV |
| | CUSTOM_PC_CPALINK |
| | CUSTOM_PC_DHAJEL |
| | CUSTOM_PC_DHAJEW |
| | CUSTOM_PC_JP1AMOAP |
| | CUSTOM_PC_JP1AMR3 |
| | CUSTOM_PC_JP1AMR3BW |
| | CUSTOM_PC_JP1AMR3CP |
| | CUSTOM_PC_JP1AMR3UX |
| | CUSTOM_PC_JP1AMR3BWUX |
| | CUSTOM_PC_JP1AMR3CPUX |
| | CUSTOM_PC_JP1FTP |
| | CUSTOM_PC_JP1SOVAR |
| | CUSTOM_PC_OAP_JOB |
| | CUSTOM_PC_R3_JOB |
| | CUSTOM_UX_JP1AMOAP |
| CUSTOM_UX_JP1AMR3 | |
| CUSTOM_UX_JP1AMR3BW | |
| CUSTOM_UX_JP1AMR3CP | |

| Category | | Description |
|---------------------|-----------------|-----------------------------|
| Standard Custom Job | | CUSTOM_UX_JP1FTP |
| User Custom Job | Custom PC Job | CUSTOM_PC_USER_<class-name> |
| | Custom UNIX Job | CUSTOM_UX_USER_<class-name> |

Note

The class name differs, depending on the program that JP1/AJS3 links with. For details, see *12.13.2 Set Properties of Custom Job dialog box* in the *JP1/Automatic Job Management System 3 Operator's Guide*.

Table 7–43: List of custom event job types

| Category | Description |
|------------------|----------------|
| Custom event job | CE_<any-name># |

#

Specify the name defined by the linked program. For details, see the applicable documentation for the linked program.

7.3.2 Status information object

This object indicates the status information of the unit.

For details about whether the API can acquire the status information object, see *D.3 List of members of the status information object that can be acquired by the API*.

Format

```
{
  "unitName": "unit-full-path-name",
  "execID": "execution-ID",
  "status": "status",
  "schStartTime": "scheduled-start-time",
  "startTime": "start-time",
  "reStartTime": "rerun-start-time",
  "endTime": "end-time",
  "startDelayStatus": "whether-the-start-delayed",
  "nestStartDelayStatus": "whether-the-start-delayed-under-the-unit",
  "endDelayStatus": "whether-the-end-delayed",
  "nestEndDelayStatus": "whether-the-end-delayed-under-the-unit",
  "startDelayTime": "time-when-start-delayed",
  "endDelayTime": "time-when-end-delayed",
  "changeType": "whether-the-plan-has-changed",
  "holdAttr": "hold-attribute",
  "registerTime": "time-when-job-registered",
  "jobNumber": "job-number",
  "retCode": "return-code",
  "execHost": "execution-host-name",
  "simpleUnitName": "unit-name",
  "waiting": "whether-there-are-wait-conditions-that-have-not-been-met",
  "delayedStart": "start-delay-monitoring-method",
  "delayedStartTime": "time-to-start-monitoring-of-start-delay",
  "delayedEnd": "end-delay-monitoring-method",
  "delayedEndTime": "time-to-start-monitoring-of-end-delay",
  "monitoringJobnet": "end-delay-monitoring-method-using-the-time-required-to-execute-jobnet",
}
```

```

"timeRequiredForExecution": "time-required-to-execute-jobnet"
"destHostName": "connection-destination-host-name",
"destServiceName": "connection-destination-scheduler-service-name",
"destUnitName": "connection-destination-unit-name",
"destExecID": "connection-destination-execution-ID",
"srcHostName": "connection-source-host-name",
"srcServiceName": "connection-source-scheduler-service-name",
"srcUnitName": "connection-source-unit-name",
"srcExecID": "connection-source-execution-ID",
"execOrderMethod": "execution-order-control-method"
}

```

Member

The following table lists and describes the members to be returned.

Table 7–44: List of members of the status information object

| Member | Data type | Description |
|------------------|-----------|---|
| unitName | string | Returns the full name of the unit, by using a character string in the range from 1 to 930 bytes. If information cannot be acquired, a character string of 0 bytes is returned. |
| execID | string | Returns the execution ID in the format of @[mmmm]{A to Z}nnnn (for example, @10A200). If information cannot be acquired, a character string of 0 bytes is returned. |
| status | string | Returns the unit status, by using a character string constant specified for the Status constant. For details about the Status constant, see 7.4.1(2) Status . If information cannot be acquired, NONE (not applicable) is returned. |
| schStartTime | string | Returns the scheduled start time. For the scheduled start time, the time (unit: second) passed from Jan 1, 1970, 00:00:00 is converted to the following ISO 8601 format: <i>YYYY-MM-DDThh:mm:ssTZD</i> For details about the ISO 8601 format, see 6.3 Data types usable for an API . If information cannot be acquired, a character string of 0 bytes is returned. |
| startTime | string | Returns the start date. For the start date, the time (unit: second) passed from Jan 1, 1970, 00:00:00 is converted to the following ISO 8601 format: <i>YYYY-MM-DDThh:mm:ssTZD</i> For details about the ISO 8601 format, see 6.3 Data types usable for an API . If information cannot be acquired, a character string of 0 bytes is returned. |
| reStartTime | string | Returns the return start time. For the return start time, the time (unit: second) passed from Jan 1, 1970, 00:00:00 is converted to the following ISO 8601 format: <i>YYYY-MM-DDThh:mm:ssTZD</i> For details about the ISO 8601 format, see 6.3 Data types usable for an API . If information cannot be acquired, a character string of 0 bytes is returned. |
| endTime | string | Returns the end time. For the end time, the time (unit: second) passed from Jan 1, 1970, 00:00:00 is converted to the following ISO 8601 format: <i>YYYY-MM-DDThh:mm:ssTZD</i> For details about the ISO 8601 format, see 6.3 Data types usable for an API . If information cannot be acquired, a character string of 0 bytes is returned. |
| startDelayStatus | string | Returns whether the start delay occurred for this unit, by using a character string constant specified for the DelayStart constant. For details about the DelayStart constant, see 7.4.1(3) DelayStart . If information cannot be acquired, NONE (not applicable) is returned. |

| Member | Data type | Description |
|----------------------|-----------|---|
| nestStartDelayStatus | string | Returns whether the start delay occurred under this unit, by using a character string constant specified for the DelayStart constant. For details about the DelayStart constant, see 7.4.1(3) DelayStart . If information cannot be acquired, NONE (not applicable) is returned. |
| endDelayStatus | string | Returns whether the end delay occurred for this unit, by using a character string constant specified for the Delayend constant. For details about the DelayEnd constant, see 7.4.1(4) DelayEnd . If information cannot be acquired, NONE (not applicable) is returned. |
| nestEndDelayStatus | string | Returns whether the end delay occurred under this unit, by using a character string constant specified for the Delayend constant. For details about the DelayEnd constant, see 7.4.1(4) DelayEnd . If information cannot be acquired, NONE (not applicable) is returned. |
| startDelayTime | string | Returns the time when start delayed. For the time when start delayed, the time (unit: second) passed from Jan 1, 1970, 00:00:00 is converted to the following ISO 8601 format: <i>YYYY-MM-DDThh:mm:ssTZD</i> For details about the ISO 8601 format, see 6.3 Data types usable for an API . If information cannot be acquired, a character string of 0 bytes is returned. |
| endDelayTime | string | Returns the time when end delayed. For the time when end delayed, the time (unit: second) passed from Jan 1, 1970, 00:00:00 is converted to the following ISO 8601 format: <i>YYYY-MM-DDThh:mm:ssTZD</i> For details about the ISO 8601 format, see 6.3 Data types usable for an API . If information cannot be acquired, a character string of 0 bytes is returned. |
| changeType | string | Returns whether the plan has been changed, by using a character string constant specified for the ChangeType constant. For details about the ChangeType constant, see 7.4.5(1) ChangeType . If information cannot be acquired, NONE (not applicable) is returned. |
| holdAttr | string | Returns the hold attribute, by using a character string constant specified for the HoldAttr constant. For details about the HoldAttr constant, see 7.4.5(2) HoldAttr . If information cannot be acquired, NONE (not applicable) is returned. |
| registerTime | string | Returns the time when the job registered. For the time when the job registered, the time (unit: second) passed from Jan 1, 1970, 00:00:00 is converted to the following ISO 8601 format: <i>YYYY-MM-DDThh:mm:ssTZD</i> For details about the ISO 8601 format, see 6.3 Data types usable for an API . If information cannot be acquired, a character string of 0 bytes is returned. |
| jobNumber | int | Returns the job number. If information cannot be acquired, or if the unit has no information, -1 is returned. |
| retCode | string | Returns the end code, by using a character string. If information cannot be acquired, or if the unit has no information, a character string of 0 bytes is returned. |
| execHost | string | Returns the execution host name, by using a character string in the range from 0 to 255 bytes. If information cannot be acquired, or if the unit has not started, a character string of 0 bytes is returned. |

| Member | Data type | Description |
|--------------------------|-----------|---|
| simpleUnitName | string | Returns the unit name, by using a character string in the range from 1 to 30 bytes. If information cannot be acquired, a character string of 0 bytes is returned. |
| waiting | string | Returns whether there are wait conditions that are have not been met, by using a character string constant that is supported by the <code>Waiting</code> constant. If information cannot be acquired, <code>NONE</code> (not applicable) is returned. For details about the <code>Waiting</code> constant, see 7.4.5(4) Waiting . |
| delayedStart | string | Returns the method of monitoring start delays by using a character string defined in the <code>DelayMonitor</code> constant. If information cannot be acquired, <code>NONE</code> (not applicable) is returned. For details about the <code>DelayMonitor</code> constant, see 7.4.5(5) DelayMonitor . |
| delayedStartTime | string | Returns the time to start monitoring start delays. The time is returned as follows, with the <code>DelayMonitor</code> constant acquired by the <code>delayedStart</code> member: <ul style="list-style-type: none"> If the <code>DelayMonitor</code> constant is <code>ABSOLUTE</code> This member returns the time to start monitoring of start delays in <i>hh:mm</i> format. <i>hh</i>: A value from 00 to 47 (hours) <i>mm</i>: A value from 00 to 59 (minutes) If the <code>DelayMonitor</code> constant is <code>ROOT</code>, <code>TOP</code>, or <code>OWN</code> This member returns the relative time (in minutes) to start monitoring of start delays in the range from 1 to 2879. If the <code>DelayMonitor</code> constant is other than <code>ABSOLUTE</code>, <code>ROOT</code>, <code>TOP</code>, and <code>OWN</code>, a character string of 0 bytes is returned. |
| delayedEnd | string | Returns the method of monitoring end delays by using a character string defined in the <code>DelayMonitor</code> constant. If information cannot be acquired, <code>NONE</code> (not applicable) is returned. For details about the <code>DelayMonitor</code> constant, see 7.4.5(5) DelayMonitor . |
| delayedEndTime | string | Returns the time to start monitoring of end delays. The time is returned as follows, with the <code>DelayMonitor</code> constant acquired by the <code>delayedEnd</code> member: <ul style="list-style-type: none"> If the <code>DelayMonitor</code> constant is <code>ABSOLUTE</code> This member returns the time to start monitoring of end delays in <i>hh:mm</i> format. <i>hh</i>: A value from 00 to 47 (hours) <i>mm</i>: A value from 00 to 59 (minutes) If the <code>DelayMonitor</code> constant is <code>ROOT</code>, <code>TOP</code>, or <code>OWN</code> This member returns the relative time (in minutes) to start monitoring of end delays in the range from 1 to 2879. If the <code>DelayMonitor</code> constant is other than <code>ABSOLUTE</code>, <code>ROOT</code>, <code>TOP</code>, and <code>OWN</code>, a character string of 0 bytes is returned. |
| monitoringJobnet | string | Returns the method of monitoring end delays based on the time required for jobnet execution by using a character string defined in the <code>MonitoringJobnet</code> constant. If information cannot be acquired, <code>NONE</code> (not applicable) is returned. For details about the <code>MonitoringJobnet</code> constant, see 7.4.5(6) MonitoringJobnet . |
| timeRequiredForExecution | string | Returns the time required for jobnet execution. The time is returned as follows, with the <code>MonitoringJobnet</code> constant acquired by the <code>monitoringJobnet</code> member: |

| Member | Data type | Description |
|--------------------------|-----------|---|
| timeRequiredForExecution | string | <ul style="list-style-type: none"> If the MonitoringJobnet constant is TIME_REQUIRED_FOR_EXECUTION_YES, this member returns the time required for jobnet execution (in minutes) in the range from 1 to 2879. If the MonitoringJobnet constant is other than TIME_REQUIRED_FOR_EXECUTION_YES, a character string of 0 bytes is returned. When information cannot be acquired, a character string of 0 bytes is returned. |
| destHostName | string | <p>If YES (obtain connection information) is specified for the searchConnectInfo parameter, returns the name of the connection-destination host by using a character string consisting of 1 to 255 bytes.</p> <p>For the following cases, a character string of 0 bytes is returned:</p> <ul style="list-style-type: none"> If the type of the specified unit is not a jobnet connector If NO (do not obtain connection information) is specified for the searchConnectInfo parameter |
| destServiceName | string | <p>If YES (obtain connection information) is specified for the searchConnectInfo parameter, returns the name of the connection-destination scheduler service by using a character string in the range from 1 to 30 bytes.</p> <p>For the following cases, a character string of 0 bytes is returned:</p> <ul style="list-style-type: none"> If the type of the specified unit is not a jobnet connector If NO (do not obtain connection information) is specified for the searchConnectInfo parameter |
| destUnitName | string | <p>If YES (obtain connection information) is specified for the searchConnectInfo parameter, returns the full name of the connection-destination unit by using a character string in the range from 0 to 930 bytes.</p> <p>For the following cases, a character string of 0 bytes is returned:</p> <ul style="list-style-type: none"> If the type of the specified unit is not a jobnet connector If NO (do not obtain connection information) is specified for the searchConnectInfo parameter |
| destExecID | string | <p>If YES (obtain connection information) is specified for the searchConnectInfo parameter, returns the execution ID of the connection destination by using a character string in the format of @[mmmm]{A to Z}nnnn (for example, @10A200).</p> <p>For the following cases, a character string of 0 bytes is returned:</p> <ul style="list-style-type: none"> If the execution-ID of the Destination does not exist If the type of the specified unit is not a jobnet connector If the connection partner unit is in the following status: <ul style="list-style-type: none"> - The connection partner unit does not exist. - The type of the connection partner unit is incorrect. - The name of the unit to connect is blank. If NO (do not obtain connection information) is specified for the searchConnectInfo parameter <p>If an error occurs during authentication of another scheduler service and the execution-ID cannot be obtained, the character string -2 is returned.</p> <p>If an error occurs in processing to obtain connection information because of a reason other than those for -2, the character string -1 is returned.</p> |
| srcHostName | string | <p>If YES (obtain connection information) is specified for the searchConnectInfo parameter, returns the name of the connection-source host by using a character string consisting of 1 to 255 bytes.</p> <p>For the following cases, a character string of 0 bytes is returned:</p> <ul style="list-style-type: none"> If the type of the specified unit is not a root jobnet |

| Member | Data type | Description |
|-----------------|-----------|---|
| srcHostName | string | <ul style="list-style-type: none"> If the setting is specified so that the execution order is not controlled If NO (do not obtain connection information) is specified for the <code>searchConnectInfo</code> parameter |
| srcServiceName | string | <p>If YES (obtain connection information) is specified for the <code>searchConnectInfo</code> parameter, returns the name of the connection-source scheduler service by using a character string in the range from 1 to 30 bytes.</p> <p>For the following cases, a character string of 0 bytes is returned:</p> <ul style="list-style-type: none"> If the type of the specified unit is not a root jobnet If the setting is specified so that the execution order is not controlled If NO (do not obtain connection information) is specified for the <code>searchConnectInfo</code> parameter |
| srcUnitName | string | <p>If YES (obtain connection information) is specified for the <code>searchConnectInfo</code> parameter, returns the full name of the connection-source unit by using a character string in the range from 0 to 930 bytes.</p> <p>For the following cases, a character string of 0 bytes is returned:</p> <ul style="list-style-type: none"> If the type of the specified unit is not a root jobnet If the setting is specified so that the execution order is not controlled If NO (do not obtain connection information) is specified for the <code>searchConnectInfo</code> parameter |
| srcExecID | string | <p>If YES (obtain connection information) is specified for the <code>searchConnectInfo</code> parameter, returns the execution ID of the connection source by using a character string in the format of <code>@[mmmm]{A to Z}nnnn</code> (for example, <code>@10A200</code>).</p> <p>For the following cases, a character string of 0 bytes is returned:</p> <ul style="list-style-type: none"> If the execution-ID of the Destination does not exist If the type of the specified unit is not a root jobnet If the connection partner unit is in the following status: <ul style="list-style-type: none"> The connection partner unit does not exist. The type of the connection partner unit is incorrect. The name of the unit to connect is blank. If the setting is specified so that the execution order is not controlled If NO (do not obtain connection information) is specified for the <code>searchConnectInfo</code> parameter <p>If an error occurs during authentication of another scheduler service and the execution-ID cannot be obtained, the character string <code>-2</code> is returned.</p> <p>If an error occurs in processing to obtain connection information because of a reason other than those for <code>-2</code>, the character string <code>-1</code> is returned.</p> |
| execOrderMethod | string | <p>If YES (obtain connection information) is specified for the <code>searchConnectInfo</code> parameter, returns the execution order control method by using a character string constant that is supported by the <code>ExecOrderMethod</code> constant.</p> <p>For the following cases, NONE (not applicable) is returned:</p> <ul style="list-style-type: none"> If the type of the specified unit is not a root jobnet If the setting is specified so that the execution order is not controlled If NO (do not obtain connection information) is specified for the <code>searchConnectInfo</code> parameter <p>For details about the <code>ExecOrderMethod</code> constant, see 7.4.5(7) ExecOrderMethod.</p> |

7.3.3 Release information object

This object indicates the release information of the unit.

For details about whether the API can acquire the release information object, see [D.4 List of members of the release information object that can be acquired by the API](#).

Format

```
{
  "releaseTime": "release-date",
  "releaseID": "release-ID",
  "releaseStatus": "release-status"
}
```

Member

The following table lists and describes the members to be returned.

Table 7–45: List of members of the release information object

| Member | Data type | Description |
|---------------|-----------|--|
| releaseTime | string | Returns the release date. For the release date, the time (unit: second) passed from Jan 1, 1970, 00:00:00 is converted to the following ISO 8601 format: <i>YYYY-MM-DDThh:mm:ssTZD</i> For details about the ISO 8601 format, see 6.3 Data types usable for an API . If information cannot be acquired, or if the unit has no information, a character string of 0 bytes is returned. |
| releaseID | string | Returns the release ID by using a character string in the range from 1 to 30 bytes. If information cannot be acquired, or if the unit has no information, a character string of 0 bytes is returned. |
| releaseStatus | string | Returns the release status, by using a character string constant specified for the ReleaseStatus constant. For details about the ReleaseStatus constant, see 7.4.6(1) ReleaseStatus . If information cannot be acquired, or if the unit has no information, NONE (not applicable) is returned. |

7.3.4 Start condition parameter object

This object indicates the start condition parameter.

Format

```
{
  "times": times-for-the-valid-range-of-start-condition,
  "period": "period-for-the-valid-range-of-start-condition",
  "periodType": "period-type-for-the-valid-range-of-start-condition"
}
```

Member

The following table lists and describes the members to be returned.

Table 7–46: List of members of the start condition parameter object

| Member | Data type | Description | Required? |
|------------|-----------|--|-----------|
| times | int | Specify the times for the valid range of start condition, by using a number in the range from 1 to 999. If you do not want to limit the times, specify 0. If you omit specifying this member, 0 is assumed. | -- |
| period | string | Specify the period for the valid range of start condition. If you specify ABSOLUTE (absolute time) or RELATIVE (relative time) for the time type for the <code>periodType</code> member, make sure that you specify the period for this member. If you do not specify this member or specify <code>null</code> for this member, an error occurs. Specify the period as follows, depending on the time type specified for the <code>periodType</code> member: <ul style="list-style-type: none"> If ABSOLUTE is specified for the <code>periodType</code> member: Specify in the format of <code>hh:mm</code>. For <code>hh</code>, you can specify a value in the range from 00 to 47 (unit: hour). For <code>mm</code>, you can specify a value in the range from 00 to 59 (unit: minute). Specify the time by using the local time for the scheduler service of the request-destination JP1/AJS3 - Manager. If RELATIVE is specified for the <code>periodType</code> member: Specify in the format of <code>hh:mm</code>. For <code>hh</code>, you can specify a value in the range from 00 to 47 (unit: hour). For <code>mm</code>, you can specify a value in the range from 00 to 59 (unit: minute). Note that, you cannot specify 00:00. You can specify in the range from 00:01 to 47:59. If NO (unlimited) is specified for the <code>periodType</code> member: The specified value is ignored. | -- |
| periodType | string | Specify the time type for the valid range of start condition, by using a value specified for the <code>TimeType</code> constant. For details about the values and contents that can be specified, see 7.4.7(1) TimeType . If you omit this member or specify <code>null</code> for this member, NO (unlimited) is assumed. | -- |

Legend:

--: Optional

7.3.5 Macro variable object

This object indicates the macro variable.

Format

```
{
  "name": "macro-variable-name",
  "value": "passing-information"
}
```

Member

The following table lists and describes the members to be returned.

Table 7–47: List of members of the macro variable object

| Member | Data type | Description | Required? |
|--------|-----------|--|-----------|
| name | string | Specify the macro variable name in the format of <code>AJS2xxxx</code> . You do not have to add question marks (?) before and after the name. Specify <code>AJS2</code> (in upper-case letters) for the beginning part. <code>xxxx</code> indicates a character string, for which you can specify upper-case alphabetical characters, numbers, and periods (.). If you specify in a wrong format, or if you specify an invalid character, an error occurs. You can specify a character string of a maximum of 62 bytes including <code>AJS2</code> . | Y |
| value | string | Specify the passing information by using a character string in the range from 0 to 255 bytes. For the passing information, do not specify a new line character, tab character, or machine-dependent character. If you specify such a character, the information might not be passed correctly when execution registration is performed for the jobnet. | Y |

Legend:

Y: Required

7.3.6 Execution agent operation result object

This object indicates the result of an operation performed on an execution agent or execution agent group.

Format

```
{
  "execAgent": "execution-agent-name-or-execution-agent-group-name",
  "rtnCode": "result-code-of-target-processing",
  "messageID": "message-ID",
  "message": "message-text",
  "output": {
    "definitions": [execution-agent-definition-information-object, ...],
    "statuses": [execution-agent-status-object, ...],
    "text": "API-operation-result",
    "serverTime": "local-time-on-connection-destination-host"
  }
}
```

Member

The following table lists and describes the members to be returned.

Table 7–48: List of members of the Execution agent operation result object

| Member | Data type | Description |
|-----------|-----------|---|
| execAgent | string | Returns information according to the requested method as follows: <ul style="list-style-type: none">• If the <code>GET</code> method is requested Returns a character string of 0 bytes.• If the <code>POST</code> method is requested |

| Member | Data type | Description |
|-------------|-----------|--|
| execAgent | string | Returns the operation-target execution agent (execution agent name or execution agent group name) by using a character string in the range from 1 to 255 bytes. |
| rtnCode | string | Returns a code that indicates the processing result. If the processing terminates normally, 0 is returned. |
| messageID | string | Returns the message ID if the value of the rtnCode member is 0. In cases other than the above, this item returns nothing. |
| message | string | Returns the message text if the value of the rtnCode member is 0. In cases other than the above, this item returns nothing. |
| output | object | Returns information according to the requested method as follows: <ul style="list-style-type: none"> If the GET method is requested This item returns a subordinate object (<i>definitions</i> or <i>statuses</i>) that contains the information acquired by the API. If the POST method is requested, this item returns information according to the API as follows: <ul style="list-style-type: none"> - In the case of the API that checks the communication status of the job distribution delay reduction function This item returns a subordinate object (<i>text</i>) that contains the API operation result. - In cases other than the above This item returns the string <code>null</code>. |
| definitions | object[] | Returns the definition information of the registered execution agents or execution agent groups as an array of execution agent definition information objects. The returned information varies according to the API operation as follows: <ul style="list-style-type: none"> In the case of acquiring the definitions of execution agents or execution agent groups In the returned array of execution agent definition information objects, the definition information is stored in element 0. In cases other than the above This item returns the string <code>null</code>. For details about the execution agent definition information object, see 7.3.7 Execution agent definition information object . |
| statuses | object[] | Returns the statuses of the registered execution agents or execution agent groups as an array of execution agent status objects. The returned information varies according to the API operation as follows: <ul style="list-style-type: none"> In the case of acquiring a list of the statuses of execution agents or execution agent groups An array of execution agent status objects is returned. In the case of acquiring the status of an execution agent In the returned array of execution agent status objects, the status of the execution agent is stored in element 0. Note that, if the execution agent specified by <code>query</code> does not exist, a zero-element array is returned. In cases other than the above This item returns the string <code>null</code>. For details about the execution agent status object, see 7.3.8 Execution agent status object . |
| text | string | Returns a character string that indicates the API operation result. |

| Member | Data type | Description |
|------------|-----------|---|
| serverTime | string | Returns the local date and time of the JP1/AJS3 - Manager host. The number of seconds that elapsed since 0:00:00 on January 1, 1970 is returned in ISO 8601 format as follows: <i>YYYY-MM-DDThh:mm:ssTZD</i> For details about the ISO 8601 format, see 6.3 Data types usable for an API . The returned information varies according to the API operation as follows: <ul style="list-style-type: none"> In the cases of acquiring a status list of execution agents, the statuses of execution agents, or a status list of execution agent groups The time at which this information was acquired is returned. In cases other than the above This item returns the string null. |

7.3.7 Execution agent definition information object

This object indicates the definition information of an execution agent or execution agent group.

Format

```
{
  "execAgent": "execution-agent-name-or-execution-agent-group-name",
  "execHost": "execution-host-name",
  "status": "job-transfer-restriction-status",
  "conExe": ["maximum-number-of-concurrently-executable-jobs-by-time-period", ...],
  "linkAgents": ["related-execution-agents-and-their-priorities"],
  "description": "comment"
}
```

Member

The following table lists and describes the members to be returned.

Table 7–49: List of members of the Execution agent definition information object

| Member | Data type | Description |
|-----------|-----------|--|
| execAgent | string | Returns information based on the mode parameter specified in query as follows: <ul style="list-style-type: none"> If the value of mode is agent (execution agent) This item returns the name of the execution agent by using a character string in the range from 1 to 255 bytes. If the value of mode is agentGroup (execution agent group) This item returns the name of the execution agent group by using a character string in the range from 1 to 255 bytes. |
| execHost | string | Returns information based on the mode parameter specified in query as follows: <ul style="list-style-type: none"> If the value of mode is agent (execution agent) This item returns the name of the job execution host by using a character string in the range from 1 to 255 bytes. If the value of mode is agentGroup (execution agent group) This item is not returned. |
| status | string | Returns information based on the mode parameter specified in query as follows: |

| Member | Data type | Description |
|-------------|-----------|---|
| status | string | <ul style="list-style-type: none"> If the value of <code>mode</code> is <code>agent</code> (execution agent) This item returns the job transfer restriction status of the execution agent by using a character string constant that is supported by the <code>ExecAgentStatus</code> constant. If the value of <code>mode</code> is <code>agentGroup</code> (execution agent group) This item returns the job transfer restriction status of the execution agent group by using a character string constant that is supported by the <code>ExecAgentStatus</code> constant. <p>For details about the <code>ExecAgentStatus</code> constant, see 7.4.14(1) ExecAgentStatus.</p> |
| conExe | string[] | <p>Returns information based on the <code>mode</code> parameter specified in <code>query</code> as follows:</p> <ul style="list-style-type: none"> If the value of <code>mode</code> is <code>agent</code> (execution agent) This item returns an array that contains the maximum number of concurrently executable jobs for each time period. The maximum number of concurrently executable jobs for each time period is returned in the following format: <i>time-period=maximum-number-of-concurrently-executable-jobs</i> The value of <i>time-period</i> is in <i>hh:mm-hh:mm</i> format. The value of <i>hh</i> is a numeric value in the range from 0 to 23 (unit: hour). The value of <i>mm</i> is 0 or 30 (unit: minute). The value of <i>maximum-number-of-concurrently-executable-jobs</i> is a numeric value in the range from 0 to 4294967295. If the value of <code>mode</code> is <code>agentGroup</code> (execution agent group), this item returns the string <code>null</code>. |
| linkAgents | string[] | <p>Returns information based on the <code>mode</code> parameter specified in <code>query</code> as follows:</p> <ul style="list-style-type: none"> If the value of <code>mode</code> is <code>agent</code> (execution agent) This item returns the string <code>null</code>. If the value of <code>mode</code> is <code>agentGroup</code> (execution agent group) This item returns an array that contains the related execution agents and their priority levels. The related execution agents and their priority levels are returned in the following format: <i>execution-agent-name:priority-level</i> The value of <i>execution-agent-name</i> is a character string in the range from 1 to 255 bytes. The value of <i>priority-level</i> is a numeric value in the range from 1 to 16. If there are no related execution agents, this item returns a zero-element array. |
| description | string | Returns a description by using a character string of no more than 80 bytes. |

7.3.8 Execution agent status object

This object indicates the status of an execution agent or execution agent group.

Format

```
{
  "execAgent": "execution-agent-name-or-execution-agent-group-name",
  "execHost": "execution-host-name",
  "status": "job-transfer-restriction-status",
```

```

"comStatus": "execution-agent-status",
"conExe": maximum-number-of-concurrently-executable-jobs,
"job": number-of-currently-running-jobs,
"event": number-of-currently-running-event-jobs-and-number-of-currently-running-custom-event-jobs,
"que": number-of-currently-queued-jobs,
"linkAgents": ["related-execution-agents-and-their-priority-levels"],
"description": "comment"
}

```

Member

The following table lists and describes the members to be returned.

Table 7–50: List of members of the Execution agent status object

| Member | Data type | Description |
|-----------|-----------|--|
| execAgent | string | Returns information based on the mode parameter specified in query as follows: <ul style="list-style-type: none"> If the value of mode is agent (execution agent) This item returns the name of the execution agent by using a character string in the range from 1 to 255 bytes. If the value of mode is agentGroup (execution agent group) This item returns the name of the execution agent group by using a character string in the range from 1 to 255 bytes. |
| execHost | string | Returns information based on the mode parameter specified in query as follows: <ul style="list-style-type: none"> If the value of mode is agent (execution agent) This item returns the name of the job execution host by using a character string in the range from 1 to 255 bytes. If the value of mode is agentGroup (execution agent group) This item is not returned. |
| status | string | Returns information based on the mode parameter specified in query as follows: <ul style="list-style-type: none"> If the value of mode is agent (execution agent) This item returns the job transfer restriction status of the execution agent by using a character string constant that is supported by the ExecAgentStatus constant. If the value of mode is agentGroup (execution agent group) This item returns the job transfer restriction status of the execution agent group by using a character string constant that is supported by the ExecAgentStatus constant. For details about the ExecAgentStatus constant, see 7.4.14(1) ExecAgentStatus . |
| comStatus | string | Returns information based on the mode parameter specified in query as follows: <ul style="list-style-type: none"> If the value of mode is agent (execution agent) This item returns the status of the execution agent by using a character string constant that is supported by the ComStatus constant. Note, however, that if the job distribution delay reduction function is disabled, this item returns the string NONE (not applicable). If the value of mode is agentGroup (execution agent group) This item is not returned. For details about the ComStatus constant, see 7.4.14(2) ComStatus . |

| Member | Data type | Description |
|-------------|-----------|---|
| conExe | long | Returns information based on the <code>mode</code> parameter specified in <code>query</code> as follows: <ul style="list-style-type: none"> If the value of <code>mode</code> is <code>agent</code> (execution agent) This item returns the maximum number of concurrently executable jobs by using a numeric value in the range from 0 to 4294967295. If the value of <code>mode</code> is <code>agentGroup</code> (execution agent group) This item is not returned. |
| que | long | Returns 0 or a greater value as the number of Unix jobs, PC jobs, action jobs, custom jobs, and passing-information setting jobs that are currently queued. |
| job | long | Returns information based on the <code>mode</code> parameter specified in <code>query</code> as follows: <ul style="list-style-type: none"> If the value of <code>mode</code> is <code>agent</code> (execution agent) This item returns 0 or a greater value as the number of Unix jobs, PC jobs, action jobs, custom jobs, and passing-information setting jobs that are currently running. If the value of <code>mode</code> is <code>agentGroup</code> (execution agent group) This item is not returned. |
| event | long | Returns information based on the <code>mode</code> parameter specified in <code>query</code> as follows: <ul style="list-style-type: none"> If the value of <code>mode</code> is <code>agent</code> (execution agent) This item returns 0 or a greater value as the number of event jobs and the number of custom event jobs that are currently running. If the value of <code>mode</code> is <code>agentGroup</code> (execution agent group) This item is not returned. |
| linkAgents | string[] | Returns information based on the <code>mode</code> parameter specified in <code>query</code> as follows: <ul style="list-style-type: none"> If the value of <code>mode</code> is <code>agent</code> (execution agent) This item returns the string <code>null</code>. If the value of <code>mode</code> is <code>agentGroup</code> (execution agent group) This item returns an array that contains the related execution agents and their priority levels. The related execution agents and their priority levels are returned in the following format: <i>execution-agent-name : priority-level</i> The value of <i>execution-agent-name</i> is a character string in the range from 1 to 255 bytes. The value of <i>priority-level</i> is a numeric value in the range from 1 to 16. If there are no related execution agents, this item returns a zero-element array. |
| description | string | Returns a description by using a character string of no more than 80 bytes. |

7.4 Details of constants

This section describes the formats and details of the constants released for JP1/AJS3.

7.4.1 Constants commonly used by APIs

(1) DateType

This constant indicates whether to specify a period by using a calendar date or by using the execution date in JP1/AJS3.

The following table lists and describes the character string constants for the `DateType` constant.

Table 7–51: List of the character string constants for the `DateType` constant

| Constant | Description |
|----------------|---|
| CALENDAR_DATE | Specifies a period by using a calendar date. |
| EXECUTION_DATE | Specifies a period by using the execution date. |

(2) Status

This constant indicates the status of the unit.

The following table lists and describes the character string constants for the `Status` constant.

Table 7–52: List of the character string constants for the `Status` constant

| Constant | Description |
|---------------|---|
| NONE | Indicates that there is no unit. |
| UNSUPPORTED | Indicates an unsupported type. |
| NOENTRY | Information of the units whose status is <i>Not registered</i> will be acquired. |
| NOPLAN | Information of the units whose status is <i>Not sched. to exe.</i> will be acquired. |
| UNEXEC | Information of the units whose status is <i>Not executed + Ended</i> will be acquired. |
| BYPASS | Information of the units whose status is <i>Bypassed</i> will be acquired. |
| EXECDEFER | Information of the units whose status is <i>Skipped so not exe.</i> will be acquired. |
| SHUTDOWN | Information of the units whose status is <i>Shutdown</i> will be acquired. |
| TIMEWAIT | Information of the units whose status is <i>Wait for start time</i> will be acquired. |
| TERMWAIT | Information of the units whose status is <i>Wait for prev. to end</i> will be acquired. |
| EXECWAIT | Information of the units whose status is <i>Waiting to execute</i> will be acquired. |
| QUEUING | Information of the units whose status is <i>Now queuing</i> will be acquired. |
| CONDITIONWAIT | Information of the units whose status is <i>Wait for start cond.</i> will be acquired. |
| HOLDING | Information of the units whose status is <i>Being held</i> will be acquired. |
| RUNNING | Information of the units whose status is <i>Now running</i> will be acquired. |
| WACONT | Information of the units whose status is <i>Ended with warning</i> will be acquired. |

| Constant | Description |
|---------------|--|
| ABCONT | Information of the units whose status is <i>Running + Abend</i> will be acquired. |
| MONITORING | Information of the units whose status is <i>Now monitoring</i> will be acquired. |
| ABNORMAL | Information of the units whose status is <i>Ended abnormally</i> will be acquired. |
| INVALIDSEQ | Information of the units whose status is <i>Invalid exe. seq.</i> will be acquired. |
| INTERRUPT | Information of the units whose status is <i>Interrupted</i> will be acquired. |
| KILL | Information of the units whose status is <i>Killed</i> will be acquired. |
| FAIL | Information of the units whose status is <i>Failed to start</i> will be acquired. |
| UNKNOWN | Information of the units whose status is <i>Unknown end status</i> will be acquired. |
| MONITORCLOSE | Information of the units whose status is <i>Monitor terminated</i> will be acquired. |
| WARNING | Information of the units whose status is <i>Ended with warning</i> will be acquired. |
| NORMAL | Information of the units whose status is <i>Ended normally</i> will be acquired. |
| NORMALFALSE | Information of the units whose status is <i>Normal end + False</i> will be acquired. |
| UNEXECMONITOR | Information of the units whose status is <i>Unmonitored + Ended</i> will be acquired. |
| MONITORINTRPT | Information of the units whose status is <i>Interrupted monitoring</i> will be acquired. |
| MONITORNORMAL | Information of the units whose status is <i>Monitor-end normal</i> will be acquired. |

(3) DelayStart

This constant indicates whether a start was delayed.

The following table lists and describes the character string constants for the DelayStart constant.

Table 7–53: List of the character string constants for the DelayStart constant

| Constant | Description |
|-------------|---------------------------------------|
| NONE | Indicates that there is no unit. |
| UNSUPPORTED | Indicates an unsupported type. |
| YES | Indicates that start was delayed. |
| NO | Indicates that start was not delayed. |

(4) DelayEnd

This constant indicates whether an end was delayed.

The following table lists and describes the character string constants for the DelayEnd constant.

Table 7–54: List of the character string constants for the DelayEnd constant

| Constant | Description |
|-------------|-------------------------------------|
| NONE | Indicates that there is no unit. |
| UNSUPPORTED | Indicates an unsupported type. |
| YES | Indicates that the end was delayed. |

| Constant | Description |
|----------|---|
| NO | Indicates that the end was not delayed. |

7.4.2 Constants used by the unit list acquisition API

(1) LowerType

This constant indicates whether to acquire the jobs under the relevant unit.

The following table lists and describes the character string constants for the `LowerType` constant.

Table 7–55: List of the character string constants for the `LowerType` constant

| Constant | Description |
|----------|---|
| YES | All units (jobs) under the relevant unit will be acquired. |
| NO | Only the units directly under the relevant unit will be acquired. |

(2) SearchTargetType

This constant indicates the range of information to be acquired.

The following table lists and describes the character string constants for the `SearchTargetType` constant.

Table 7–56: List of the character string constants for the `SearchTargetType` constant

| Constant | Description |
|-----------------------|--|
| DEFINITION | Only the unit definition will be acquired. |
| DEFINITION_AND_STATUS | The definition and status of the unit will be acquired, considering the execution status and generation of the unit. |

(3) MatchMethods

This constant indicates the comparison method for a character string.

The following table lists and describes the character string constants for the `MatchMethods` constant.

Table 7–57: List of the character string constants for the `MatchMethods` constant

| Constant | Description |
|----------|--|
| NO | This comparison method is not used as the search condition. |
| EQ | Completely match the value in the search condition. (perfect match). |
| BW | Begin with the value in the search condition. (begins-with match). |
| EW | End with the value in the search condition. (ends-with match). |
| NE | Do not match the value in the search condition. (no match). |
| CO | Contain the value in the search condition. |
| NC | Do not contain the value in the search condition. |

| Constant | Description |
|----------|--|
| RE | The value in the search condition is treated as the regular expression. For details about the regular expression, see Table 7-58 . |

Table 7–58: Symbols that can be specified as a regular expression, specification examples, and example results of acquisition

| Symbol | Description | Specification example | Example results of acquisition |
|--------|--|-----------------------|--------------------------------|
| ? | Any one character | A? | AB, A1, A?, A*, A\ |
| | | ?E | DE, 1E, ?E, *E, \E |
| * | Any character string | B* | B, BC, B12, B?* \ |
| \ | Uses the symbol immediately after this symbol as a character | C\? | C? |

(4) UnitType

This constant indicates the unit type of the unit whose information will be acquired.

The following table lists and describes the character string constants for the `UnitType` constant.

Table 7–59: List of the character string constants for the UnitType constant

| Constant | Description |
|----------|---|
| NO | Unit type is not considered in the search condition. |
| GROUP | Only the job group information will be acquired. Information of the units that have the following unit types will be acquired: <ul style="list-style-type: none"> • Job group • Planning group • Manager job group |
| ROOT | Only the root jobnet information will be acquired. Information of the units that have the following unit types will be acquired: <ul style="list-style-type: none"> • Root jobnet • Root remote jobnet • Root manager jobnet |
| NET | Only the jobnet information will be acquired. Information of the units that have the following unit types will be acquired: <ul style="list-style-type: none"> • Root jobnet • Root Remote jobnet • Manager jobnet • Nested jobnet • Nested remote jobnet |
| JOB | Only the job information will be acquired. Information of the units that have the following unit types will be acquired: <ul style="list-style-type: none"> • Standard job • Event job • Action job • Custom job • Passing information setting job |

| Constant | Description |
|----------|---|
| JOB | <ul style="list-style-type: none"> • HTTP connection job • Flexible Job • Custom event job |

(5) GenerationType

This constant indicates the generation of the unit whose information will be acquired.

The following table lists and describes the character string constants for the GenerationType constant.

Table 7–60: List of the character string constants for the GenerationType constant

| Constant | Description |
|----------|---|
| NO | Generation is not considered in the search condition. |
| STATUS | The latest generation will be acquired. The generation to be acquired depends on the value set for the VIEWSTATUSRANGE environment setting parameter of the JP1/AJS3 - Manager you logged in. For details about the VIEWSTATUSRANGE environment setting parameter, see 20.4.2(70) VIEWSTATUSRANGE in the JP1/Automatic Job Management System 3 Configuration Guide. |
| RESULT | The generation in the latest result will be acquired. |
| PERIOD | The generations that exist in the specified period will be acquired. |
| EXECID | The generation for the specified execution ID will be acquired. |

(6) UnitStatus

This constant indicates the status of the unit whose information will be acquired.

The following table lists and describes the character string constants for the UnitStatus constant.

Table 7–61: List of the character string constants for the UnitStatus constant

| Constant | Description |
|---------------|---|
| NO | Unit status is not considered in the search condition. |
| UNREGISTERED | Information of the units whose status is <i>Not registered</i> will be acquired. |
| NOPLAN | Information of the units whose status is <i>Not sched. to exe.</i> will be acquired. |
| UNEXEC | Information of the units whose status is <i>Not executed + Ended</i> will be acquired. |
| BYPASS | Information of the units whose status is <i>Bypassed</i> will be acquired. |
| EXECDEFFER | Information of the units whose status is <i>Skipped so not exe.</i> will be acquired. |
| SHUTDOWN | Information of the units whose status is <i>Shutdown</i> will be acquired. |
| TIMEWAIT | Information of the units whose status is <i>Wait for start time</i> will be acquired. |
| TERMWAIT | Information of the units whose status is <i>Wait for prev. to end</i> will be acquired. |
| EXECWAIT | Information of the units whose status is <i>Waiting to execute</i> will be acquired. |
| QUEUING | Information of the units whose status is <i>Now queuing</i> will be acquired. |
| CONDITIONWAIT | Information of the units whose status is <i>Wait for start cond.</i> will be acquired. |
| HOLDING | Information of the units whose status is <i>Being held</i> will be acquired. |

| Constant | Description |
|---------------|---|
| RUNNING | Information of the units whose status is <i>Now running</i> will be acquired. |
| WACONT | Information of the units whose status is <i>Ended with warning</i> will be acquired. |
| ABCONT | Information of the units whose status is <i>Running + Abend</i> will be acquired. |
| MONITORING | Information of the units whose status is <i>Now monitoring</i> will be acquired. |
| ABNORMAL | Information of the units whose status is <i>Ended abnormally</i> will be acquired. |
| INVALIDSEQ | Information of the units whose status is <i>Invalid exe. seq.</i> will be acquired. |
| INTERRUPT | Information of the units whose status is <i>Interrupted</i> will be acquired. |
| KILL | Information of the units whose status is <i>Killed</i> will be acquired. |
| FAIL | Information of the units whose status is <i>Failed to start</i> will be acquired. |
| UNKNOWN | Information of the units whose status is <i>Unknown end status</i> will be acquired. |
| MONITORCLOSE | Information of the units whose status is <i>Monitor terminated</i> will be acquired. |
| WARNING | Information of the units whose status is <i>Ended with warning</i> will be acquired. |
| NORMAL | Information of the units whose status is <i>Ended normally</i> will be acquired. |
| NORMALFALSE | Information of the units whose status is <i>Normal end + False</i> will be acquired. |
| UNEXECMONITOR | Information of the units whose status is <i>Unmonitored + Ended</i> will be acquired. |
| MONITORINTRPT | Information of the units whose status is <i>Interrupted monitoring</i> will be acquired. |
| MONITORNORMAL | Information of the units whose status is <i>Monitor-end normal</i> will be acquired. |
| GRP_WAIT | Information of the units with one of the following statuses will be acquired: <ul style="list-style-type: none"> • Wait for start time • Wait for prev. to end • Waiting to execute • Now queuing • Wait for start cond. |
| GRP_RUN | Information of the units with one of the following statuses will be acquired: <ul style="list-style-type: none"> • Now running • Running + Warning • Running + Abend • Now monitoring |
| GRP_ABNORMAL | Information of the units with one of the following statuses will be acquired: <ul style="list-style-type: none"> • Ended abnormally • Invalid exe. seq. • Interrupted • Killed • Failed to start • Unknown end status • Monitor terminated |
| GRP_NORMAL | Information of the units with one of the following statuses will be acquired: <ul style="list-style-type: none"> • Ended normally • Normal end + False • Unmonitored + Ended • Interrupted monitoring • Monitor-end normal |

(7) DelayType

This constant indicates whether the start or end delay occurred for the unit whose information will be acquired.

The following table lists and describes the character string constants for the `DelayType` constant.

Table 7–62: List of the character string constants for the `DelayType` constant

| Constant | Description |
|----------|--|
| NO | Whether a start or end delay occurred is not considered in the search condition. |
| START | Information of the units for which the start delay occurred will be acquired. |
| END | Information of the units for which the end delay occurred will be acquired. |
| YES | Information of the units for which the start or end delay occurred will be acquired. |

(8) HoldPlan

This constant indicates whether there is a hold plan for the unit whose information will be acquired.

The following table lists and describes the character string constants for the `HoldPlan` constant.

Table 7–63: List of the character string constants for the `HoldPlan` constant

| Constant | Description |
|-----------|--|
| NO | Whether there is a hold plan is not considered in the search condition. |
| PLAN_NONE | Information of the units for which no hold plan exists will be acquired. |
| PLAN_YES | Information of the units for which a hold plan exists will be acquired. |

(9) ReleaseInfoSearchMethods

This constant indicates the release ID of the unit whose information will be acquired.

The following table lists and describes the character string constants for the `ReleaseInfoSearchMethods` constant.

Table 7–64: List of the character string constants for the `ReleaseInfoSearchMethods` constant

| Constant | Description |
|----------|---|
| NO | Release ID is not considered in the search condition. |
| ID | Release ID is considered in the search condition. |

7.4.3 Constants used by the execution registration API

(1) PlannedTimePassedType

This constant indicates the type of behavior when the planned time has passed at the startup of the scheduler service or at execution registration.

The following table lists and describes the character string constants for the `PlannedTimePassedType` constant.

Table 7–65: List of the character string constants for the PlannedTimePassedType constant

| Constant | Description |
|-----------|--|
| IMMEDIATE | The jobnet is immediately executed if the planned time has passed at the startup of the scheduler service or at execution registration. |
| NEXTTIME | The jobnet is not executed if the planned time has passed at the startup of the scheduler service or at execution registration. The jobnet is executed when the planned time next occurs. Note that if you specify this value when you perform fixed execution registration by specifying the date and time, the jobnet is not executed if the planned time has passed. |

7.4.4 Constants used by the unit definition information object

(1) Type

This constant indicates the unit type.

The following table lists and describes the character string constants for the `Type` constant.

Table 7–66: List of the character string constants for the Type constant

| Constant | Description |
|-------------|--|
| NONE | Indicates that there is no unit that matches the search condition. |
| UNSUPPORTED | Indicates an unsupported type. |
| GROUP | Indicates a job group. |
| MANGROUP | Indicates a manager job group. |
| PLNGROUP | Indicates a planning group. |
| ROOTNET | Indicates a root jobnet. |
| NET | Indicates a nested jobnet. |
| ROOTRMNET | Indicates a root remote jobnet. |
| RMNET | Indicates a root nested remote jobnet. |
| MANNET | Indicates a manager jobnet. |
| JOB | Indicates a Unix job. |
| PJOB | Indicates a PC job. |
| QJOB | Indicates a Queue job. |
| NETCN | Indicates a Jobnet Connector. |
| JDJOB | Indicates a Judgment job. |
| ORJOB | Indicates an OR job. |
| CMSJB | Indicates an OpenView Status Report job. |
| EVWJB | Indicates a Receive JP1 Event job. |
| FLWJB | Indicates a Monitoring Files job. |
| MLWJB | Indicates a Receive Mail job. |

| Constant | Description |
|----------|--|
| MQWJB | Indicates a Receive MQ Message job. |
| MSWJB | Indicates a Receive MSMQ Message job. |
| LFWJB | Indicates a Monitoring Log Files job. |
| NTWJB | Indicates a Monitoring Event Log job. |
| TMWJB | Indicates an Interval Control job. |
| EVSJB | Indicates a Send JPI Event job. |
| MLSJB | Indicates a Send Mail job. |
| MQSJB | Indicates a Send MQ Message job. |
| MSSJB | Indicates a Send MSMQ Message job. |
| PWLJB | Indicates a Local Power Control job. |
| PWRJB | Indicates a Remote Power Control job. |
| COND | Indicates the start condition. |
| AJSVAR | Indicates a Passing information setting job. |
| HTPJ | Indicates an HTTP connection job. |
| FXJ | Indicates a Flexible job. |
| CUSTOM | Indicates a Custom job. |
| EVCUSTOM | Indicates a Custom event job. |

(2) RegisterStatus

This constant indicates the registration status of the unit.

The following table lists and describes the character string constants for the RegisterStatus constant.

Table 7–67: List of the character string constants for the RegisterStatus constant

| Constant | Description |
|-------------|--|
| NONE | Indicates that there is no unit that matches the search condition. |
| UNSUPPORTED | Indicates an unsupported type. |
| YES | Indicates a registered unit. |
| NO | Indicates an unregistered unit. |

7.4.5 Constants used by the status information object

(1) ChangeType

This constant indicates whether the plan was temporarily changed.

The following table lists and describes the character string constants for the ChangeType constant.

Table 7–68: List of the character string constants for the ChangeType constant

| Constant | Description |
|-------------|---|
| NONE | Indicates that there is no unit. |
| UNSUPPORTED | Indicates an unsupported type. |
| NO | Indicates that there was no plan change. |
| TIME | Indicates that the time was changed. |
| CANCEL | Indicates that the execution was canceled. |
| MOVEMENT | Indicates that there was a linked change (the start time was changed due to a plan change). |

(2) HoldAttr

This constant indicates the hold attribute.

The following table lists and describes the character string constants for the HoldAttr constant.

Table 7–69: List of the character string constants for the HoldAttr constant

| Constant | Description |
|-------------|---|
| NONE | Indicates that there is no unit. |
| UNSUPPORTED | Indicates an unsupported type. |
| NO | Indicates that the definition is followed (do not hold). |
| YES | Indicates that the definition is followed (hold). |
| YES_ERR | Indicates that the definition is followed (hold only if an error occurred the previous time). |
| YES_WAR | Indicates that the definition is followed (hold only if an error warning was issued the previous time). |
| HOLD | Indicates that there is holding. |
| RELEASE | Indicates that there is no holding. |

(3) TimeType

This constant indicates the time type for the valid range of the start condition.

The following table lists and describes the character string constants for the TimeType constant.

Table 7–70: List of the character string constants for the TimeType constant

| Constant | Description |
|-------------|--|
| NONE | Indicates that there is no unit. |
| UNSUPPORTED | Indicates an unsupported type. |
| NO | Indicates that no time type is specified. |
| ABSOLUTE | Indicates the absolute time. |
| RELATIVE | Indicates the relative time. |
| UNLIMITED | Indicates that the time type is not limited. |

(4) Waiting

This constant indicates whether there are wait conditions that have not been met.

The following table lists and describes the character string constants for the `Waiting` constant.

Table 7–71: List of the character string constants for the `Waiting` constant

| Constant | Description |
|-------------|--|
| NONE | Indicates that there is no information. |
| UNSUPPORTED | Indicates an unsupported type. |
| WAITING_YES | Indicates that there are wait conditions that have not been met. |
| WAITING_NO | Indicates that all wait conditions have been met. |

(5) DelayMonitor

This constant indicates the method of monitoring delays for jobnets.

The following table lists and describes the character string constants for the `DelayMonitor` constant.

Table 7–72: List of the character string constants for the `DelayMonitor` constant

| Constant | Description |
|-------------|---|
| NONE | Indicates that there is no information. |
| UNSUPPORTED | Indicates an unsupported type. |
| NOT | Indicates delay monitoring is not performed. |
| ABSOLUTE | Indicates delay monitoring using an absolute time. |
| ROOT | Indicates delay monitoring using a relative time from the scheduled start time of the root jobnet. |
| TOP | Indicates delay monitoring using a relative time from the scheduled start time of the upper jobnet. |
| OWN | Indicates delay monitoring using a relative time from the scheduled start time of the local jobnet. |

(6) MonitoringJobnet

This constant indicates the method of monitoring end delays based on the time required for jobnet execution.

The following table lists and describes the character string constants for the `MonitoringJobnet` constant.

Table 7–73: List of the character string constants for the `MonitoringJobnet` constant

| Constant | Description |
|---------------------------------|--|
| NONE | Indicates that there is no information. |
| UNSUPPORTED | Indicates an unsupported type. |
| TIME_REQUIRED_FOR_EXECUTION_NO | Indicates that end delays in jobnet execution are not monitored based on the time required for jobnet execution. |
| TIME_REQUIRED_FOR_EXECUTION_YES | Indicates that end delays in jobnet execution are monitored based on the time required for jobnet execution. |

(7) ExecOrderMethod

This constant indicates the execution order control method of a jobnet.

The following table lists and describes the character string constants for the ExecOrderMethod constant.

Table 7–74: List of the character string constants for the ExecOrderMethod constant

| Constant | Description |
|--------------|---|
| NONE | Indicates that there is no information. |
| UNSUPPORTED | Indicates an unsupported type. |
| ASYNC | Indicates that the definition is followed (asynchronous). |
| SYNC | Indicates that the definition is followed (synchronous). |
| CHANGE_ASYNC | Indicates that the asynchronous method is applied. |
| CHANGE_SYNC | Indicates that the synchronous method is applied. |

7.4.6 Constants used by the release information object

(1) ReleaseStatus

This constant indicates the release status.

The following table lists and describes the character string constants for the ReleaseStatus constant.

Table 7–75: List of the character string constants for the ReleaseStatus constant

| Constant | Description |
|--------------------|--|
| NONE | Indicates that there is no unit that matches the search condition. |
| UNSUPPORTED | Indicates an unsupported type. |
| RELEASE_WAIT | Indicates Release wait. |
| BEING_APPLIED | Indicates Being applied. |
| APPLIED | Indicates Applied. |
| DELETE_WAIT | Indicates Delete wait. |
| RELEASE_ENTRY_WAIT | Indicates Release entry wait. |

7.4.7 Constants used by the start condition parameter object

(1) TimeType

This constant indicates the time type for the valid range of the start condition.

The following table lists and describes the character string constants for the TimeType constant.

Table 7–76: List of the character string constants for the TimeType constant

| Constant | Description |
|----------|---|
| ABSOLUTE | Indicates the absolute time. |
| RELATIVE | Indicates the relative time. |
| NO | Indicates that the type is not limited. |

7.4.8 Constants used by the change hold attribute API

(1) ChangeHoldAttr

This constant indicates a change of the hold attribute.

The following table lists and describes the character string constants for the ChangeHoldAttr constant.

Table 7–77: List of the character string constants for the ChangeHoldAttr constant

| Constant | Description |
|----------|--|
| SET | Indicates that the hold attribute is set. |
| RELEASE | Indicates that the hold attribute is released. |

7.4.9 Constants used by the change plan API

(1) ChangeStartTimeType

This constant indicates the type of the execution start time when a plan is changed temporarily.

The following table lists and describes the character string constants for the ChangeStartTimeType constant.

Table 7–78: List of the character string constants for the ChangeStartTimeType constant

| Constant | Description |
|--------------|------------------------------|
| ABSOLUTETIME | Specifies the absolute time. |
| RELATIVETIME | Specifies the relative time. |

(2) ChangePushedAheadType

This constant indicates how the start time is pushed ahead when a plan is changed temporarily.

The following table lists and describes the character string constants for the ChangePushedAheadType constant.

Table 7–79: List of the character string constants for the ChangePushedAheadType constant

| Constant | Description |
|----------|--|
| ADD | Indicates that a new schedule will be added. |

| Constant | Description |
|----------|---|
| MOVE | Indicates that the next schedule will be moved. |

(3) ChangeLowerType

This constant indicates whether to change the start time of lower jobnets when the plan of an upper jobnet is changed temporarily.

The following table lists and describes the character string constants for the `ChangeLowerType` constant.

Table 7–80: List of the character string constants for the `ChangeLowerType` constant

| Constant | Description |
|----------|--|
| NOTSHIFT | The start time of lower jobnets is not changed. The start time of only the specified jobnet is changed. |
| SHIFT | The start time of lower jobnets is also changed. The start time of all the nested jobnets under the specified jobnet is changed relatively. |

7.4.10 Constants used by the rerun API

(1) RootRerunType

This constant indicates how to rerun a root jobnet.

The following table lists and describes the character string constants for the `RootRerunType` constant.

Table 7–81: List of the character string constants for the `RootRerunType` constant

| Constant | Description |
|-----------------|---|
| TOP | Reruns jobs from the first job of the specified root jobnet. |
| ABNORMAL_JOB | Reruns jobs in the specified root jobnet from the job that ended abnormally. |
| ABNORMAL_NEXT | Reruns jobs in the specified root jobnet from the next job of the abnormally ended job. |
| ABNORMAL_JOBNET | Reruns nested jobnets in the root jobnet from the jobnet that ended abnormally. |
| WARNING | Reruns only the jobs that ended with warning in the specified root jobnet. |

(2) RerunType

This constant indicates how to rerun a nested jobnet or job.

The following table lists and describes the character string constants for the `RerunType` constant.

Table 7–82: List of the character string constants for the `RerunType` constant

| Constant | Description |
|----------|---|
| FROM | Reruns the specified unit, and then continues processing of the succeeding units. |
| ONLY | Reruns the specified unit only. |

| Constant | Description |
|----------|--|
| NEXT | Reruns units from the next unit of the specified unit. |

(3) RerunOption

This constant indicates the rerun options.

The following table lists and describes the character string constants for the `RerunOption` constant.

Table 7–83: List of the character string constants for the `RerunOption` constant

| Constant | Description |
|----------|--|
| HOLD | The unit to rerun is placed in hold status. If the unit to rerun is a nested jobnet or a job, you can specify this value only when <code>FROM</code> or <code>ONLY</code> is specified for the <code>RerunType</code> constant that specifies the rerun method. If you specify this value when <code>NEXT</code> is specified for the <code>RerunType</code> constant, an error occurs. If the unit to rerun is a jobnet connector, you cannot specify this value. |
| WARNING | The end status of an abnormal preceding unit, if any, is changed to <i>Ended with warning</i> . If the unit to rerun is a root jobnet, you can specify this value only when <code>ABNORMAL_NEXT</code> is specified for the <code>RootRerunType</code> constant that specifies the rerun method. For any other rerun method, specifying this value causes an error. |

7.4.11 Constants used by the change delay monitor API

(1) DelayMonitorType

This constant indicates the method of monitoring delays for jobnets.

The following table lists and describes the character string constants for the `DelayMonitorType` constant.

Table 7–84: List of the character string constants for the `DelayMonitorType` constant

| Constant | Description |
|-------------------|---|
| NOT | Indicates that monitoring is not performed. |
| ABSOLUTE | Indicates delay monitoring using an absolute time. |
| ROOT [#] | Indicates delay monitoring using a relative time from the scheduled start time of the root jobnet. |
| TOP [#] | Indicates delay monitoring using a relative time from the scheduled start time of the upper jobnet. |
| OWN | Indicates delay monitoring using a relative time from the scheduled start time of the local jobnet. |

[#]
This value cannot be specified if the unit for which the delay status is to be changed is a root jobnet.

(2) MonitoringJobnetType

This constant indicates the method of end delay monitoring based on the time required for executing the jobnet.

The following table lists and describes the character string constants for the `MonitoringJobnetType` constant.

Table 7–85: List of the character string constants for the MonitoringJobnetType constant

| Constant | Description |
|-----------------------------|---|
| NOT | Indicates that monitoring is not performed. |
| TIME_REQUIRED_FOR_EXECUTION | Indicates delay monitoring based on the time required for executing the jobnet. |

7.4.12 Constants used by the change job status API

(1) ChangeStatus

This constant indicates the job status after change.

The following table lists and describes the character string constants for the ChangeStatus constant.

Table 7–86: List of the character string constants for the ChangeStatus constant

| Constant | Description |
|------------|---|
| NORMAL | The job status is set to <i>Ended normally</i> . |
| FAIL | The job status is set to <i>Failed to start</i> . |
| WARNING | The job status is set to <i>Ended with warning</i> . |
| ABNORMAL | The job status is set to <i>Ended abnormally</i> . |
| BYPASS | The job status is set to <i>Bypassed</i> . |
| RETURNCODE | The job status is determined by the return code, and then changed to the specified return code. |

7.4.13 Constants used for waiting

(1) WaitMethod

This constant indicates a condition under which a unit waits for the end of other units.

The following table lists and describes the character string constants for the Waitmethod constant.

Table 7–87: List of the character string constants for the Waitmethod constant

| Constant | Description |
|----------|---|
| AND | The job waits until the execution of all other units ends. |
| OR | The job waits until the execution of one of the other units ends. |

(2) WaitingAction

This constant indicates the action of a unit with wait conditions.

The following table lists and describes the character string constants for the WaitingAction constant.

Table 7–88: List of the character string constants for the `WaitingAction` constant

| Constant | Description |
|---------------------------------|---|
| <code>EXECUTE</code> | Indicates that the execution of a unit with wait conditions starts. |
| <code>NOT_EXECUTE</code> | Indicates that the execution of a unit with wait conditions does not start. |
| <code>NOT_EXECUTE_DEFFER</code> | Indicates that the execution of a unit with wait conditions does not start. However, if the execution generation is in the <i>Skipped so not exe.</i> status, execution of the unit starts. |

(3) `WaitingStatus`

This constant indicates the waiting statuses of a unit with wait conditions and its waiting-target units.

The following table lists and describes the character string constants for the `WaitingStatus` constant.

Table 7–89: List of the character string constants for the `WaitingStatus` constant

| Constant | Description |
|----------------------------------|--|
| <code>INCOMPLETE</code> | Indicates that the relevant units are in the <i>Wait incomplete</i> status. |
| <code>INCOMPLETE_MANUALLY</code> | Indicates that the relevant units are in the <i>Wait incomplete (manual)</i> status. |
| <code>INCOMPLETE_RERUN</code> | Indicates that the relevant units are in the <i>Wait incomplete (rerun)</i> status. |
| <code>COMPLETE</code> | Indicates that the relevant units are in the <i>Wait complete</i> status. |
| <code>COMPLETE_MANUALLY</code> | Indicates that the relevant units are in the <i>Wait complete (manual)</i> status. |

(4) `WaitingStatusAction`

This constant indicates whether waiting is enabled or disabled.

The following table lists and describes the character string constants for the `WaitingStatusAction` constant.

Table 7–90: List of the character string constants for the `WaitingStatusAction` constant

| Constant | Description |
|----------------------|-------------------------------------|
| <code>ENABLE</code> | Indicates that waiting is enabled. |
| <code>DISABLE</code> | Indicates that waiting is disabled. |

7.4.14 Constants used for execution agent objects

(1) `ExecAgentStatus`

This constant indicates the job transfer restriction status of an execution agent or execution agent group.

The following table lists and describes the character string constants for the `ExecAgentStatus` constant.

Table 7–91: List of the character string constants for the `ExecAgentStatus` constant

| Constant | Description |
|------------------------|---|
| <code>EFFECTIVE</code> | Indicates that job transfer restriction is enabled for the execution agent. |

| Constant | Description |
|-------------|--|
| INEFFECTIVE | Indicates that job transfer restriction is disabled for the execution agent. |
| HOLD | Indicates that job transfer restriction is held for the execution agent. |
| BLOCKADE | Indicates that job transfer restriction is blocked for the execution agent. |

(2) ComStatus

This constant indicates the status of an execution agent.

The following table lists and describes the character string constants for the `ComStatus` constant.

Table 7–92: List of the character string constants for the `ComStatus` constant

| Constant | Description |
|---------------|---|
| NONE | Indicates that the job distribution delay reduction function is disabled on the manager host. |
| NOTCHECKED | Indicates that the execution agent is in the <i>not checked</i> status. |
| CONNECTABLE | Indicates that the execution agent is in the <i>connectable</i> status. |
| UNCONNECTABLE | Indicates that the execution agent is in the <i>unconnectable</i> status. |
| UNAVAILABLE | Indicates that the execution agent is in the <i>unavailable</i> status. |

7.4.15 Constants used by the execution order control method change API

(1) ChangeExecOrderMethod

This constant indicates the new execution order control method to which the current method is to be changed.

The following table lists and describes the character string constants for the `ChangeExecOrderMethod` constant.

Table 7–93: List of the character string constants for the `ChangeExecOrderMethod` constant

| Constant | Description |
|----------|--|
| ASYNC | Indicates that the method is changed to the asynchronous method. |
| SYNC | Indicates that the method is changed to the synchronous method. |

7.4.16 Constant used by the unit information acquisition API

(1) ConnectInfoType

Indicates whether to obtain connection information when obtaining the Status information object (`unitStatus`) of the Resource for status monitoring.

The following table lists and describes the character string constants for the `ConnectInfoType` constant.

Table 7–94: List of the character string constants for the ConnectInfoType constant

| Constant | Description |
|----------|--------------------------------------|
| YES | obtain connection information |
| NO | do not obtain connection information |

For details about the status information object, see [7.3.2 Status information object](#). The connection information is the following members.

Table 7–95: List of members of the connection information

| Member name | Description |
|-----------------|---|
| destHostName | connection destination host name |
| destServiceName | connection destination scheduler service name |
| destUnitName | connection destination unit name |
| destExecID | connection destination execution ID |
| srcHostName | connection source host name |
| srcServiceName | connection source scheduler service name |
| srcUnitName | connection source unit name |
| srcExecID | connection source execution ID |
| execOrderMethod | execution order control method |

Appendixes

A. Notes on Defining Environment Variables and an Environment Variable File

A.1 Notes on defining environment variables

This section describes the notes on defining environment variables for job execution.

For a list of environment variables, see the environment variable list in [1.4 Environment variables](#).

- Use the *environment-variable-name=value* format to specify an environment variable. To specify more than one environment variable, use a line-feed character to separate each entry, as shown in the following example.

Example:

```
environment-variable-name-1=ABCD<line-feed character>
```

```
environment-variable-name-2=EFGH<line-feed character>
```

You can separate each entry only by using a line-feed character. Do not use a delimiter such as a semicolon (;) or a colon (:).

- Make sure that you specify all entries in the *environment-variable-name=value* format. If you specify an entry that is not in this format, the job could terminate abnormally depending on the OS of the host on which the job is executed.
- You cannot use environment variables that start with `AJS` (for example, `AJSxxxx`, where `xxxx` is any string) regardless of whether you specify them in uppercase or lowercase. These variables are reserved in the system.
- You cannot use environment variables that start with `JP1` (for example, `JP1xxxx`, where `xxxx` is any string) regardless of whether you specify them in uppercase or lowercase. These variables are reserved in the system.
- You cannot set the environment variables (those shown in [Table 1-6](#) in [1.4.2 Environment variables set when a job is executed from JP1/AJS3](#)) that are set when a job is executed for environment variables of a job definition or in a file you specify for environment file of a job definition.
- Usually, environment variables are set in `JP1/AJS3` and they refer to those listed in [Table 1-6](#) in [1.4.2 Environment variables set when a job is executed from JP1/AJS3](#), as well as those specified for job definition, and those contained in files specified as environment files for job definition. In addition, environment variables may also be set in the command statements, script files, local login scripts, and system login scripts specified for job definition. If the same environment variables are found in these, they will have the following levels of priority (with the value of 1 as the highest level).

Windows

1. Environment variables specified for **Environment variables**^{#1}
2. Environment variables specified for **Environment file**^{#2}
3. System environment variables

UNIX

1. Definitions in the commands or script files specified for job definition
2. Definitions contained in local login scripts
3. Definitions contained in system login scripts
4. Environment variables specified for **Environment variables**^{#1}
5. Environment variables specified for **Environment file**^{#2}
6. Environment variables set when the queueless agent service starts^{#3}.

#1

Variables specified for **Environment variables** in the JP1/AJS3 - View window or those specified with the `-env` option for the `jpqj obsub` command.

#2

Variables specified for **Environment file** in the JP1/AJS3 - View window or those specified with the `-ev` option for the `jpqj obsub` command.

#3

Applicable only when the service to be executed is for **Queueless Agent** jobs.

- When defining an environment variable in a dialog box of JP1/AJS3 - View or in the `-env` option of the `jpqj obsub` command, you cannot use a reference to an environment variable. In the following example, the `xyz` variable is assigned the character string `%abc%`, and not the value of the `abc` environment variable.

Example:

```
abc=1
xyz=%abc%
```

If you want to use a reference to an environment variable, specify the reference in the batch file or script file for the job to be executed.

Cautionary note

In Windows, JP1/AJS3 services normally start with the system environment variables as the settings. User environment variables are not read. Job execution is also governed by these system environment variables. However, when the system is configured as a cluster system with logical hosts, the Failover Clustering[#] reads the user environment variables at system startup. The user environment variables take effect in the JP1/AJS3 services started by the Failover Clustering on the logical hosts, and are also used at job execution.

In addition to the system environment variables, the environment variables set at OS startup are also read when JP1/AJS3 services are activated.

#

For clustering software other than Failover Clustering, see the software specifications.

A.2 Notes on defining an environment variable file

Before attempting to define an environment variable name in an environment variable file used for job execution, make sure that the name is valid in the operating system running on the target host.

If the target host does not support the environment variable name you define, the specification of the variable in the environment variable file will not take effect. In such a case, the environment variable is not set on the host.

The following gives precautions about syntax you must follow when defining environment variables in an environment variable file used for job execution:

(1) Notes on defining an environment variable file in a Windows environment

- Code an environment variable name from the beginning of a line.
- When specifying multiple environment variables, insert a line feed character between pairs of *environment-variable-name=value*.

Example:

```
environment-variable-name-1=ABCD <return>
```

```
environment-variable-name-2=EFGH <return>
```

- Make sure that you specify all entries in the *environment-variable-name=value* format. If you specify an entry that is not in this format, the job could terminate abnormally depending on the OS of the host on which the job is executed.
- A sequence of characters between "=" and the line feed code is assumed to be a single value.
- You cannot use environment variables that start with AJS (for example, AJSxxxx, where xxxx is any string) regardless of whether you specify them in uppercase or lowercase. These variables are reserved in the system.
- You cannot use environment variables that start with JP1 (for example, JP1xxxx, where xxxx is any string) regardless of whether you specify them in uppercase or lowercase. These variables are reserved in the system.
- Avoid using the environment variables (those shown in [Table 1-6](#) in [1.4.2 Environment variables set when a job is executed from JP1/AJS3](#)) because their values are set in JP1/AJS3.
- You cannot use a reference to an environment variable as shown in the following example.

In the following example, the xyz variable is assigned the character string %abc%, and not the value of the abc environment variable.

Example:

```
abc=1
```

```
xyz=%abc%
```

If you want to use a reference to an environment variable, specify the reference in the batch file for the job to be executed.

(2) Notes on defining an environment variable file in a UNIX environment

- Code an environment variable name from the beginning of a line.
- When specifying multiple environment variables, insert a line feed character between pairs of *environment-variable-name=value*.

Example:

```
environment-variable-name-1=ABCD <return>
```

```
environment-variable-name-2=EFGH <return>
```

- Make sure that you specify all entries in the *environment-variable-name=value* format. If you specify an entry that is not in this format, the job could terminate abnormally depending on the OS of the host on which the job is executed.
- A sequence of characters between "=" and the line feed code is assumed to be a single value.
- You cannot use environment variables that start with AJS (for example, AJSxxxx, where xxxx is any string) regardless of whether you specify them in uppercase or lowercase. These variables are reserved in the system.
- You cannot use environment variables that start with JP1 (for example, JP1xxxx, where xxxx is any string) regardless of whether you specify them in uppercase or lowercase. These variables are reserved in the system.
- Avoid using the environment variables (those shown in [Table 1-6](#) in [1.4.2 Environment variables set when a job is executed from JP1/AJS3](#)) because their values are set in JP1/AJS3.
- You cannot use a reference to an environment variable as shown in the following example.

In the following example, the xyz variable is assigned the character string \$abc, and not the value of the abc environment variable.

Example:

```
abc=1
```

```
xyz=$abc
```

If you want to use a reference to an environment variable, specify the reference in the script file for the job to be executed.

B. Notes on Using the Embedded-Database Commands

When you use the `ajsembdbadduser` command to add a new user or modify an existing user, the following embedded-database commands allow you to use the authorization identifier (`-a`) and the password (`-ap`) of the user who executes those commands:

- `ajsembdbstatus`
- `ajsembdbbrorg`
- `ajsembdbreclaim`
- `ajsembdbsetup`

The following describes the `-a` and `-ap` options.

`-a` *command-executer-authorization-identifier*

Specify the authorization identifier of the user who executes the applicable command.

You usually do not need to specify this option because, `root` is assumed as the authorization identifier. Specify it only if you have used the `ajsembdbadduser` command to add a new administrator for the embedded database, or if you have modified the existing administrator.

The specified value is case sensitive.

`-ap` *command-executer-password*

Specify the password corresponding to the authorization identifier specified in the `-a` option.

You usually do not need to specify this option because `root` is assumed as the password. Specify it only if you have used the `ajsembdbadduser` command to add a new administrator for the embedded database, or if you have modified the existing administrator.

The specified value is case sensitive.

An error might occur when you execute a command. If an error occurs, take the action indicated in the following table and re-execute the command.

| Message | Cause | Action to be taken |
|-------------|---|---|
| KAVS0983-E | The database cannot be connected because there is an error in the user name or the password. | Specify correct values in the <code>-a</code> and <code>-ap</code> options, and then re-execute the command. If this error occurs while the <code>SHIFT TABLE</code> message is being output, check the configuration definition. The configuration definition must contain pre-migration settings that work correctly. |
| KAVS1003-E | The value specified for <code>-a</code> option is invalid. | For <code>-a</code> option, specify the authorization identifier of an existing database administrator. |
| KFPA11564-E | The character string specified for <code>-a</code> option exceeds 8 bytes. | Reduce the argument specified for <code>-a</code> option to 8 or fewer bytes and re-execute the command. |
| KFPA11107-E | The character string specified for <code>-ap</code> option exceeds 30 bytes. | Reduce the argument specified for <code>-ap</code> option to 30 or fewer bytes, and then re-execute the command. |
| KFPA11104-E | Characters other than alphanumeric characters are specified in an argument of <code>-a</code> or <code>-ap</code> option. | Use alphanumeric characters for the argument of <code>-a</code> or <code>-ap</code> option, and then re-execute the command. |

| Message | Cause | Action to be taken |
|-------------|--|---|
| KFPA11204-E | No table exists. | Check the values specified for <code>-a</code> and <code>-ap</code> options, and then specify the authorization identifier of the table owner. |
| KFPA11561-E | The specified authorization identifier is not valid. | Change the values specified for <code>-a</code> and <code>-ap</code> options to the values of the user with who has the DBA permission, and the re-execute the command. |

B.1 Adding a new administrator for the embedded database or changing an existing administrator

This section describes how to add a new administrator for the embedded database and modify the existing administrator.

For the embedded database, a database administrator is created by default. Both the authorization identifier of the default database administrator and the password are `root`. When you use the `ajsembdbadduser` command, you can add a new database administrator or change the existing password.

For details on the `ajsembdbadduser` command, see [B.3 *ajsembdbadduser*](#).

To execute the `ajsembdbadduser` command, you need to set the environment variable `PDUSER`. Check the following setting examples, and then set the environment variable `PDUSER`.

- Setting example for a Windows host

```
x:\> set PDUSER="root"/"root"
```
- Setting example for a UNIX host

```
# PDUSER='root"/"root"'
# export PDUSER
```

Note

When an AJS administrator is set, an administrator user with the authorization identifier and password both being set to *OS-user-name-of-the-AJS-administrator* is created in addition to the default embedded database administrator `root`.

Example

Changing the password of the database administrator with the authorization identifier `root` to `jp1ajs2`

- For a Windows host
(The embedded database installation previous directory is `c:\Program Files\HITACHI\JP1AJS2\embdb_JF0`.)

```
ajsembdbadduser -i "c:\Program Files\HITACHI\JP1AJS2\embdb\_JF0" -a root -ap jp1ajs2
```
- For a UNIX host
(The embedded database installation previous directory is `/opt/jp1ajs2/embdb/_JF0`.)

```
ajsembdbadduser -i /opt/jp1ajs2/embdb/_JF0 -a root -ap jp1ajs2
```

If you change the database administrator's password, you must also change the value of the `-ap` option in the `ajsembdbrogrg` or `ajsembdbreclaim` command.

You can create a new database administrator as well.

Example

Creating a new administrator for the embedded database with the authorization identifier `jp1ajs2` and the password `jp1ajs2`

- For a Windows host

(The embedded database installation previous directory is

`c:\Program Files\HITACHI\JP1AJS2\embdb_JF0`.)

```
ajsembdbadduser -i "c:\Program Files\HITACHI\JP1AJS2\embdb\_JF0" -a
jp1ajs2 -ap jp1ajs2
```

- For a UNIX host

(The embedded database installation previous directory is `/opt/jp1ajs2/embdb/_JF0`.)

```
ajsembdbadduser -i /opt/jp1ajs2/embdb/_JF0 -a jp1ajs2 -ap jp1ajs2
```

Notes on changing database administrator passwords

- If the password for the authorization identifier `root` is changed from the default value `root`, the `ajajs_setup` command cannot be executed. If the password for the `root` authorization identifier has been changed, set up the scheduler by using advanced setup of an embedded database. For details about advanced setup of an embedded database, see *23.4 Advanced setup of an embedded database* in the *JP1/Automatic Job Management System 3 Configuration Guide*.
- If the password for the authorization identifier `root` has been changed from the default value `root` and you want to execute the following commands, specify the authorization identifier in the `-a` option and the password in the `-ap` option:

```
ajsembdbstatus
```

```
ajsembdborg
```

```
ajsembdbreclaim
```

```
ajsembdbsetup
```

For details about the `-a` and `-ap` options, see *B. Notes on Using the Embedded-Database Commands*.

- If you use multiple embedded databases on a single host and there are different settings for each `root` password, the `ajsembdbreclaim` command executed with manager specified in the `-m` option results in an error. In this case, for each embedded database that holds a scheduler service, perform maintenance by specifying the `-a` option, the `-ap` option, scheduler in the `-m` option, and the scheduler service that corresponds to the embedded database in the `-F` option. Also, for the embedded database that holds the agent management database, perform maintenance by specifying the authorization identifier in the `-a` option, the password in the `-ap` option, and agent in the `-m` option. You can check the embedded databases that hold scheduler services and the embedded database that holds the agent management database by executing the `ajsembdbidlist` command with the `-a` option specified. For details about `ajsembdbidlist` command, see *ajsembdbidlist* in *2. Commands Used during Setup*.
- When an AJS administrator is set, an administrator user with the authorization identifier and password both being set to *OS-user-name-of-the-AJS-administrator* is created in addition to the default embedded database administrator `root`. Consider changing the password for each authorization identifier.

B.2 Changing the options of the tables in the embedded database

When you specify the embedded database as the database for a scheduler service, the data storage area in the embedded database might become full faster than you expect depending on the JP1/AJS3 operation. This can occur even when the amount of data is not very large, when there is repeated addition and deletion of data, which creates invalid pages and segments reserved for tables.

This section describes the organization of the data area in the embedded database and the command that can be used to suppress the generation of invalid pages and segments.

(1) Organization of the data area in the embedded database

This subsection describes the organization of the data area in the embedded database.

The data in the embedded database is actually stored as *pages*. A group of pages is called a *segment*, each of which is associated with a table in the database for management purpose.

The following figure shows how the data area in the embedded database is managed.

Figure B–1: Managing the data area in the embedded database

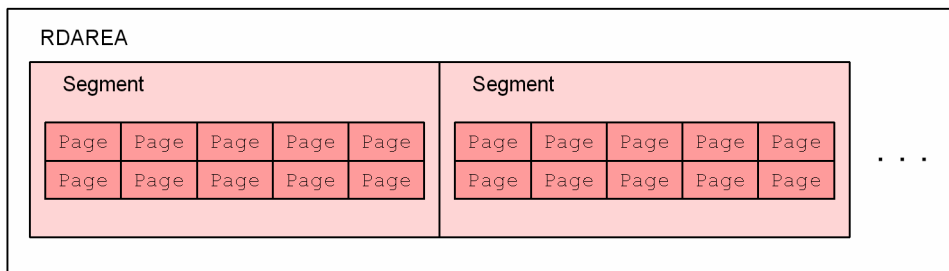

When the embedded database is accessed, the data area is used based on the following rules:

- One segment stores the information of only one table.
- When all the pages in one segment are full, a new segment is allocated to the table.
- When you delete records, pages and segments become invalid areas, and they are not usually available for automatic reuse.
- Even if a reusable segment or page exists, priority is given to unused pages and segments.

The scheduler database of JP1/AJS3 has 11 tables. If one table holds many invalid pages and segments, other tables cannot acquire new pages and segments when data needs to be stored. If as a result there are insufficient pages and segments, an error might occur.

Figure B–2: When the invalid segments of a specific table occupy all the free segments

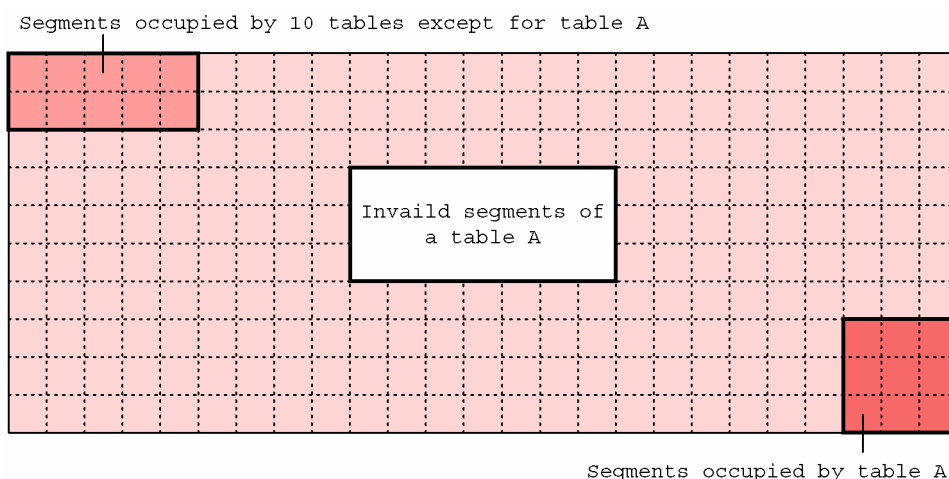

When all the segments are occupied as shown above, tables other than table A cannot acquire the unused segments even though there is new data to be stored. In this case, an error due to insufficient segments occurs, despite the existence of the invalid segments.

(2) Applying the free space reuse facility

Even when there are reusable segments, by default, the embedded database uses unallocated segments first.

The embedded database has a free space reuse facility that hastens the reuse of segments in the database area for each table. By using this functionality, the embedded database can reuse reserved segments (those that have been used and deleted) for the applicable table on a priority basis when a new segment is required and the preset number of segments is about to be exceeded.

For example, suppose you use this functionality to set a threshold value of about 50% of the number of segments for table A. When about half of the segments in the data area have been used, the embedded database temporarily stops expansion through the new allocation of segments and looks for reusable segments. As a result, the invalid segments of a specific table do not occupy free segments.

To enable the free space reuse facility during setup of the embedded database when you migrate from ISAM to the embedded database, you must specify the `-ru` option in the `ajsembdbsetup` command. For details about how to use the `ajsembdbsetup` command, see the description of *ajsembdbsetup* in 2. *Commands Used during Setup*.

To enable the free space reuse facility when you create an embedded database for a large-scale model, use the embedded database for the default scheduler service (AJSROOT1) on the physical host, and then execute the following command:

```
ajsembdbsetup -F AJSROOT1 -ru 1
```

To enable the free space reuse facility in an environment in which setup to the embedded database has been completed, you need to execute `ajsembdbreuse` command. For details on the `ajsembdbreuse` command, see *B.4 ajsembdbreuse*.

Example

Changing the definition of a table in an embedded database environment with `-l` option specified as the large data model size in `ajsembdbbuild` command

- For a Windows host

(The embedded database installation previous directory is `C:\program Files (x86)\HITACHI\JP1AJS2\embdb_JF0`.)

```
ajsembdbreuse -i "C:\program Files (x86)\HITACHI\JP1AJS2\embdb\_JF0" -l
```

- For a UNIX host

(The embedded database installation previous directory is `/opt/jp1ajs2/embdb/_JF0`.)

```
ajsembdbreuse -i /opt/jp1ajs2/embdb/_JF0 -l
```

Note that if the backup enhancement function is enabled, you will need to execute the following command in addition to the above steps.

- For a Windows host

(The embedded database installation previous directory is `C:\program Files (x86)\HITACHI\JP1AJS2\embdb_JF0`.)

```
ajsembdbreuse -i "C:\program Files (x86)\HITACHI\JP1AJS2\embdb\_JF0" -l -b
```

- For a UNIX host

(The embedded database installation previous directory is `/opt/jp1ajs2/embdb/_JF0`.)

```
ajsembdbreuse -i /opt/jp1ajs2/embdb/_JF0 -l -b
```

Example

When the `ajsembdbaddarea` command of the embedded database is used to expand the database area (the total number of AJS2DATA segments is changed to 200,000) after the embedded database environment is set up

- For a Windows host

(The embedded database installation previous directory is `C:\Program Files (x86)\HITACHI\JP1AJS2\embdb_JF0`.)

```
ajsembdbreuse -i "C:\Program Files (x86)\HITACHI\JP1AJS2\embdb\_JF0" -n 200000
```

- For a UNIX host

(The embedded database installation previous directory is `/opt/jp1ajs2/embdb/_JF0`.)

```
ajsembdbreuse -i /opt/jp1ajs2/embdb/_JF0 -n 200000
```

Note that if the backup enhancement function is enabled and the database area (AJS2DATA2) is extended, you will need to execute the following command. The following example is based on the total number of segments for AJS2DATA2 being 300.

- For a Windows host

(The embedded database installation previous directory is `C:\Program Files (x86)\HITACHI\JP1AJS2\embdb_JF0`.)

```
ajsembdbreuse -i "C:\Program Files (x86)\HITACHI\JP1AJS2\embdb\_JF0" -n 300 -b
```

- For a UNIX host

(The embedded database installation previous directory is `/opt/jp1ajs2/embdb/_JF0`.)

```
ajsembdbreuse -i /opt/jp1ajs2/embdb/_JF0 -n 300 -b
```

The free space reuse facility is effective for tables. It cannot be applied to the index area. You need to periodically maintain the index area to reclaim the invalid pages and segments that are generated in the index area. For details about how to maintain the index area, see 9.2.2(1) *Executing the ajsembdbreclaim command automatically* in the *JP1/Automatic Job Management System 3 Administration Guide* and 9.2.2(2) *Executing the ajsembdbreclaim command manually* in the *JP1/Automatic Job Management System 3 Administration Guide*.

Even if you enable the free space reuse facility, the number of occupied segments can still increase due to increased demand for services or unusual operations. For this reason, you still need to periodically monitor the unused segments in the data area.

B.3 ajsembdbadduser

Format

```
ajsembdbadduser
  [-i embedded-database-practical-directory-name]
  [-mh logical-host-name]
  [-p embedded-database-communication-port]
  -a embedded-database-administrator-authorization-identifier
  -ap embedded-database-administrator-authorization-identifier-password
```

Description

Creates a new embedded database administrator by using the specified authorization identifier and password for the authorization identifier.

When you specify the existing authorization identifier of the embedded database administrator, you can change the password.

Execution permissions

In Windows: Administrators permissions

In UNIX: Superuser permissions

Storage directory

In Windows

JP1/AJS3 - Manager-installation-folder\tools

In UNIX

/opt/jp1ajs2/tools/

Arguments

-i *embedded-database-practical-directory-name*

Specify the embedded database practical directory by using the full path to specify the directory. For Windows, if the full path contains a space character, enclose it in double quotation marks (").

You can use the `ajsembdbidlist` command to check the path to the embedded database practical directory. For details about the `ajsembdbidlist` command, see [ajsembdbidlist in 2. Commands Used during Setup](#).

When you omit this option, the following value is assumed:

For UNIX: */opt/jp1ajs2/embdb/_JF0*

For Windows: *embedded-database-practical-directory-corresponding-to-embedded-database-setup-identifier_JF0*

-mh *logical-host-name*

Specify the name of the target JP1 logical host. You can specify a character string of 1 to 32 bytes.

If you omit this option and the environment variable `JP1_HOSTNAME` has been set, the value of the environment variable is assumed. If no value is set for `JP1_HOSTNAME`, the physical host is assumed.

-p *embedded-database-communication-port*

Specify the connection port for the embedded database as a decimal number.

For the embedded database communication port to be specified, see the value specified in the `RDBPORT` environment setting parameter for the scheduler service.

You can use the `ajsembdbidlist` command to check the association between scheduler services and embedded databases. For details about the `ajsembdbidlist` command, see [ajsembdbidlist in 2. Commands Used during Setup](#).

If you omit this option, 22220 is assumed.

-a *embedded-database-administrator-authorization-identifier*

Specify the owner of the tables in the new JP1/AJS3 scheduler database to be created. For this authorization identifier, do not specify a database access user (`RDBUSER`). When you specify the existing authorization identifier of the embedded database administrator, the current password is changed to the password specified in **-ap** option.

Use eight or fewer single-byte alphanumeric characters (the first character must be an alphabetic character) for this authorization identifier.

-ap *embedded-database-administrator-authorization-identifier-password*

Specify the password for the authorization identifier of the embedded database administrator.

Use 30 or fewer single-byte alphanumeric characters (the first character must be an alphabetic character) for this password.

Notes

- You must execute this command while the embedded database is running. If you execute it while the embedded database is not running, an error occurs.
- Before you execute the `ajsembdbadduser` command, set environment variable `PDUSER` by using the authorization identifier and the authorization identifier password of the existing database administrator. If you execute the command without setting environment variable `PDUSER`, an error occurs.
- When you execute the `ajsembdbadduser` command and an error occurs during access to the embedded database server, the error information dated to the connection of the embedded database is created by the name of `pderr1.trc` and `pderr2.trc` in the working directory used when the `ajsembdbadduser` command is executed. When you re-execute the command and the embedded database server ends normally, delete these files.
- The following table lists the characters you can specify for the `-a` and `-ap` options.

| Option name | Allowed number of bytes | Single-byte characters allowed | | | | | Multi-byte characters allowed |
|------------------|-------------------------|-----------------------------------|-----------------------|-------------------|------------------|---------------|-------------------------------|
| | | Upper-case characters and numbers | Lower-case characters | Underscores (_) | Space characters | Hyphens (-) | |
| <code>-a</code> | 8 bytes | Yes | Yes | No | No | No | No |
| <code>-ap</code> | 30 bytes | Yes | Yes | No | No | No | No |

- Do not execute this command more than once in quick succession. If you do so, the command might result in an error.
- If you specify `root` in the `-a` option when attempting to change the embedded database authorization identifier password, the `jajs_setup` command might result in an error.

Return values

| | |
|--------------|--|
| 0 | Normal end (However, if an error message appears, take the action described in the message.) |
| Other than 0 | Abnormal end |

Actions to be taken if an error occurs

If an error occurs when you execute `ajsembdbadduser` command, take the action indicated in the following table.

Table B–1: Actions to be taken if an error occurs when `ajsembdbadduser` command is executed

| Message | Cause | Action to be taken |
|-------------|---|---|
| KAVS0996-E | The specified option and value are invalid. | Correct the option and the value for the option, and then re-execute the script. |
| KFPA11723-E | The embedded database is running. Alternatively, the value specified for <code>-p</code> or <code>-mh</code> option is incorrect. | Start the embedded database. If the embedded database is running, check the value specified for <code>-p</code> or <code>-mh</code> option, and then re-execute the script. |
| KFPA11564-E | The length of the character string specified for <code>-a</code> option exceeds 8 bytes. | Reduce the argument of <code>-a</code> option to 8 or fewer bytes, and re-execute the script. |
| KFPA11107-E | The length of the character string specified for <code>-ap</code> option exceeds 30 bytes. | Reduce the argument of <code>-ap</code> option to 30 or fewer bytes, and then re-execute the script. |
| KFPA11104-E | Characters other than alphanumeric characters are specified for the argument of <code>-a</code> or <code>-ap</code> option, or the first character is a number. | Use alphanumeric characters (the first character must be an alphabetic character) for the argument of <code>-a</code> or <code>-ap</code> option, and then re-execute the script. |

| Message | Cause | Action to be taken |
|--------------------------------------|--|--|
| Bad directory specified in -i option | The directory specified for -i option is not the embedded database practical directory or the embedded database is not correctly set up. | Specify the correct Embedddb practical directory in -i option. If the correct embedded database practical directory is specified, and then set up the embedded database again. |
| AuthID is not Specified | The -a option is not specified. | Specify the -a option. |
| AuthIDPassword is not Specified | The -ap option is not specified. | Specify the -ap option. |
| KAVS0101-E | No value is specified for an option that requires a value. | Specify a value for the option and then re-execute the command. |
| KFPA11724-E | Because the value specified for -p or -mh option is incorrect. The embedded database cannot be connected. | Correct the value specified for -p or -mh option, and then re-execute the script. |
| KFPA11560-E | The authorization identifier password specified for PDUSER is incorrect. | Specify the password for the authorization identifier specified for PDUSER and then re-execute the script. |
| KFPA11561-E | The specified authorization identifier is not valid. | Change the user specified for PDUSER to a user with the database administrator permission and then re-execute the script. |

B.4 ajsembdbreuse

Format

```
ajsembdbreuse
  {{-l | -m | -s | -n number-of-segments} | -D}
  [-mh logical-host-name]
  [-p embedded-database-communication-port]
  [-tp table-prefix]
  [-a embedded-database-administrator-authorization-identifier]
  [-ap embedded-database-administrator-authorization-identifier-password]
  [-i embedded-database-practical-directory-name]
  [-b]
```

Description

Allows you to apply the free space reuse facility to the JP1/AJS3 tables created in the embedded database that matches the specified prefix.

Execution permissions

In Windows: Administrators permissions

In UNIX: Superuser permissions

Storage directory

In Windows

JP1/AJS3 - Manager-installation-folder\tools\

In UNIX

/opt/jplajs2/tools/

Arguments

`-l | -m | -s | -n` *number-of-segments*

Specify the point at which you want to start using the free space reuse facility. When the usage rate of the data area reaches the threshold specified here, the free-segment reuse function starts operation.

`-l`, `-m`, and `-s` options correspond to each of the database model sizes of `ajsembddbbuild` command (`-l` for large-scale, `-m` for medium-scale, and `-s` for small-scale). Specify the option that matches the size of the database model specified in `ajsembddbbuild` command.

In the `-n` option, specify the total number of segments in the database area (AJS2DATA) when the total number of segments in the database area is different from the values for the large, medium, and small database models. For the value of `-n` option, specify a value for 100 to the number of secured segments. The value must be an integer. If you specify a value outside the range, or a value other than an integer, specify a correct value, and then re-execute the script.

To change the reuse point for the AJS1JINF table, specify the `-b` option together with the `-l`, `-m`, `-s`, or `-n` option. When you specify the `-b` option, specify the total number of database area (AJS2DATA2) segments for the `-n` option.

To check the total number of database area (AJS2DATA, AJS2DATA2) segments, execute the `ajsembdbstatus` command with the `-db` option specified.

The following table lists the point at which the free space reuse facility is applied to the database area for each table.

Table B–2: Point at which the free space reuse facility is applied

| Table name | Point at which the free space reuse facility is applied |
|---------------|--|
| AJS1UNIT | 6% of the total segments in the database area AJS2DATA (18 when the <code>-s</code> option is specified, 183 when the <code>-m</code> option is specified, and 957 when the <code>-l</code> option is specified.) |
| AJS1ARROW | |
| AJS1BODY | |
| AJS1SCH | |
| AJS1CAL | |
| AJS1PERF | |
| AJS1ENTRY | |
| AJS1GEN | |
| AJS1STAT | 16% of the total segments in the database area AJS2DATA (48 when the <code>-s</code> option is specified, 489 when the <code>-m</code> option is specified, and 2553 when the <code>-l</code> option is specified.) |
| AJS1RELS | 6% of the total segments in the database area AJS2DATA (18 when the <code>-s</code> option is specified, 183 when the <code>-m</code> option is specified, and 957 when the <code>-l</code> option is specified.) |
| AJS1ID | |
| AJSAGTEXECNT | 1% of the total segments in the database area AJS2DATA (3 when the <code>-s</code> option is specified, 30 when the <code>-m</code> option is specified, and 159 when the <code>-l</code> option is specified.) |
| AJSEXECAGT | |
| AJSEXECAGTGRP | |
| AJSLINKAGT | |
| AJS1JINF | 70% of the segments of the entire AJS2DATA2 database area (Specify 70 when <code>-s</code> , <code>-m</code> , or <code>-l</code> is specified.) |

Note

- The above table names are used when the table prefix is set to the default, AJS1.

- In the `-n` option of the `ajsembdbreuse` command, if the free space reuse start point has changed, specify the value without using a decimal point.
- The `AJS1JINF` table and database area `AJS2DATA2` exist only when the backup enhancement function is enabled.

The following table lists the total number of segments in the data area that are created in the large, medium, and small database models of `ajsembdbbuild` command.

Table B–3: Total number of segments in the data area created in the large, medium, and small database models of `ajsembdbbuild` command

| Database area name | Small scale | Medium scale | Large scale |
|--------------------------------------|-------------|--------------|-------------|
| Database area <code>AJS2DATA</code> | 300 | 3,060 | 15,960 |
| Database area <code>AJS2DATA2</code> | 100 | 100 | 100 |

`-mh` *logical-host-name*

Specify the name of the target JP1 logical host. You can specify a character string of 1 to 32 bytes.

If you omit this option, and the environment variable `JP1_HOSTNAME` has been set, the value of the environment variable is assumed. If no value is specified for `JP1_HOSTNAME`, the physical host is assumed.

`-p` *embedded-database-communication-port*

Specify the connection port for the embedded database as a decimal number.

For the embedded database communication port to be specified, see the value specified in the `RDBPORT` environment setting parameter for the scheduler service.

You can use the `ajsembdbidlist` command to check the association between scheduler services and embedded databases. For details about the `ajsembdbidlist` command, see [ajsembdbidlist in 2. Commands Used during Setup](#).

If you omit this option, 22220 is assumed.

`-tp` *table-prefix*

Specify the prefix of the names of the tables in the JP1/AJS3 scheduler database with four or fewer bytes. If you omit this option, `AJS1` is assumed.

For the table prefix to be specified, see the value of the `TABLENAMEPREFIX` environment setting parameter for the scheduler service for which you want to use the free space reuse facility.

`-a` *embedded-database-administrator-authorization-identifier*

Specify the owner of the tables in the JP1/AJS3 scheduler database.

Use eight or fewer single-byte alphanumeric characters (the first character must be an alphabetic character). If you omit this option, `root` is assumed.

`-ap` *embedded-database-administrator-authorization-identifier-password*

Specify the password for the authorization identifier of the embedded database administrator.

Use 30 or fewer single-byte alphanumeric characters (the first character must be an alphabetic character). If you omit this option, `root` is assumed.

`-D`

Disables the free space reuse facility. If you specify this option while the free space reuse facility is disabled, no error occurs.

To disable the `AJS1JINF` table reuse facility, specify the `-b` option together with this option.

`-i` *embedded-database-practical-directory-name*

Specify the embedded database practical directory by using the full path. For Windows, if the full path contains a space character, enclose it in double quotation marks ("").

You can use the `ajsembdbidlist` command to check the path to the embedded database practical directory. For details about the `ajsembdbidlist` command, see [ajsembdbidlist in 2. Commands Used during Setup](#).

When you omit this option, the following value is assumed:

For UNIX: `/opt/HIRDB_J/`

For Windows: `embedded-database-practical-directory-corresponding-to-embedded-database-setup-identifier_JF0`

-b

Specify this option to change the reuse point for the `AJS1JINF` table.

Do not specify this option when you execute the command for an embedded database for which the backup enhancement function is disabled. You can check the setting of the backup enhancement function by using the `ajsembdbstatus` command. For details about the `ajsembdbstatus` command, see [ajsembdbstatus in 3. Commands Used for Normal Operations](#).

Notes

- Before you execute this command, on the JP1/AJS3 - Manager host, stop all JP1/AJS3 services, including the services on the logical host. If you execute this command while JP1/AJS3 is accessing the embedded database, an error occurs.
- You must execute this script while the embedded database is running. If you execute it while the embedded database is not running, an error occurs.
- When you execute the `ajsembdbreuse` command and an error occurs during access to the embedded database server, the error information dated to the connection of the embedded database is created by the name of `pderr1.trc` and `pderr2.trc` in the working directory used when the `ajsembdbreuse` command is executed. When you re-execute the command, and the embedded database server ends normally, delete these files.
- Do not execute this command more than once in quick succession. If you do so, the command might result in an error.

Return values

| | |
|--------------|--|
| 0 | Normal end (However, if an error message appears, take the action described in the message.) |
| Other than 0 | Abnormal end |

Actions to be taken if an error occurs

If an error occurs when you execute `ajsembdbreuse` command, take the action indicated in the following table.

Table B-4: Actions to be taken if an error occurs when `ajsembdbreuse` command is executed

| Message | Cause | Action to be taken |
|-------------|---|---|
| KAVS0996-E | The specified option and value are invalid. | Correct the option and the value for the option, and then re-execute the script. |
| KFPA11723-E | The embedded database is running. Alternatively, the value specified for <code>-p</code> or <code>-mh</code> option is incorrect. | Start the embedded database. If the embedded database is running, check the value specified for <code>-p</code> or <code>-mh</code> option, and then re-execute the script. |
| KFPA11564-E | The length of the character string specified for <code>-a</code> option exceeds 8 bytes. | Reduce the argument of <code>-a</code> option to 8 or fewer bytes, and then re-execute the script. |
| KFPA11107-E | The length of the character string specified for <code>-ap</code> option exceeds 30 bytes. | Reduce the argument of <code>-ap</code> option to 30 or fewer bytes, and re-execute the script. |

| Message | Cause | Action to be taken |
|--|--|--|
| KFPA11104-E | Characters other than alphanumeric characters are specified for the argument of <code>-a</code> or <code>-ap</code> option. | Use alphanumeric characters for the argument of <code>-a</code> or <code>-ap</code> option, and then re-execute the script. |
| KFPA11204-E | No table exists. | Check the values specified for <code>-a</code> and <code>-ap</code> options, and then specify the authorization identifier of the table owner. Alternatively, check the value of <code>-tp</code> option and then specify a correct table prefix. Do not specify the <code>-b</code> option if the backup enhancement function is disabled. Then re-execute the script. |
| KFPA11561-E | The specified authorization identifier is not valid. | Change the values of the <code>-a</code> and <code>-ap</code> options to values for a user with DBA permission, and then re-execute the script. |
| KFPA11563-E KFPA11732-E | A lock wait timeout error occurred because another user was accessing the embedded database. | Stop all access from JP1/AJS3 to the embedded database and then re-execute the script. |
| Bad directory specified in <code>-i</code> option | The directory specified for <code>-i</code> option is not the embedded database practical directory or the embedded database is not correctly set up. | Specify the correct embedded database practical directory in <code>-i</code> option. If the correct embedded database practical directory is specified, set up the embedded database again. |
| <code>-D</code> cannot be specified with these options. | An illegal combination of the <code>-D</code> option and the <code>-l</code> , <code>-m</code> , <code>-s</code> , or <code>-n</code> option is specified. | Correct the specified option and then re-execute the script. |
| KAVS0101-E | No value is specified for an option that requires a value. | Specify a value for the option and then re-execute the command. |
| KFPA11560-E | The authorization identifier password specified for <code>-ap</code> option is incorrect. | Specify the password for the authorization identifier specified for <code>-a</code> option, and then re-execute the script. |
| KFPA11724-E | The embedded database cannot be connected, because the value specified for <code>-p</code> or <code>-mh</code> option is incorrect. | Correct the value specified for <code>-p</code> or <code>-mh</code> option, and then re-execute the script. |
| KFPA11105-E KFPA11705-E ERROR Invalid value specified in <code>-n</code> option. | An invalid value is specified for <code>-n</code> option. | Specify a value from 10 to the number of secured segments. The specified value must be an integer. |

C. Privileges Required for Operation as the AJS Administrator

C.1 Command execution privileges for operation as the AJS administrator

When operating JP1/AJS3, AJS administrators can execute commands that require superuser privileges. Note, however, that restrictions apply to the functionality of the following commands.

Table C–1: Commands that are restricted when used by an AJS administrator

| No. | Command | Restricted functionality |
|-----|---|---|
| 1 | <code>ajs2collectcore</code> (UNIX only) | Acquiring information from a core dump file requires the OS reference privilege for the core dump file. Without this privilege, this command cannot be executed. If the AJS administrator has the OS reference privilege, the administrator can execute the command. |
| 2 | <code>ajsatsetup</code> | Although the AJS administrator can execute this command, the administrator cannot register the port number. After this command is executed, a user with superuser privileges must register the port number. |
| 3 | <code>ajsbkudel</code> | The deletion of backup files and directories requires the OS execution privilege for the files and directories. Without this privilege, this command cannot be executed. If the AJS administrator has the OS execution privilege, the administrator can execute the command. |
| 4 | <code>ajschksetup</code> | Although the AJS administrator can execute this command, the administrator cannot register the port number. After this command is executed, a user with superuser privileges must register the port number. |
| 5 | <code>ajsovsetup</code> | The AJS administrator cannot set up the HP NNM linkage function by executing this command. A user with superuser privileges must execute this command to set up the HP NNM linkage function. |
| 6 | <code>ajsovremove</code> | The AJS administrator cannot remove the HP NNM linkage function by executing this command. A user with superuser privileges must execute this command to remove the HP NNM linkage function. |
| 7 | <code>ajsqlsetup</code> | Although the AJS administrator can execute this command, the administrator cannot register the port number. After this command is executed, a user with superuser privileges must register the port number. |
| 8 | <code>ajssysctlsetup</code> | Although the AJS administrator can execute this command, the administrator cannot register the port number. After this command is executed, a user with superuser privileges must register the port number. |
| 9 | <code>ajswbsetup</code> | Setting up the Web Console server requires superuser privileges. The AJS administrator cannot terminate the process. |
| 10 | <code>jajs_killall.cluster</code> (UNIX only) | Terminating a running JP1/AJS3 process requires superuser privileges. The AJS administrator cannot terminate the process. |

C.2 Access permissions for directories or files required for command operations by the AJS administrator

When an AJS administrator operates JP1/AJS3, access permissions are required to use command operations on or specify directories or files. For command operations on directories or files, the applicable access permissions must be set for the AJS administrator beforehand.

In addition, during operation by the AJS administrator, even when executing a command with superuser privileges, the AJS administrator requires access permissions for the directories or files subject to the command operations or specifications. These permissions must be set beforehand.

The following table describes the directories and files on which AJS administrators can perform command operations, and the required access permissions.

Table C–2: Access permissions required by AJS administrators for command operations on directories or files

| No. | Command | Option | File or directory requiring access permissions | Required permissions for the AJS administrator |
|-----|-----------------|--------|---|---|
| 1 | ajs2collectcore | f | Output directory | rwX |
| 2 | | - | Directory containing core dumps or core dump files | Directory containing core dumps: rx Core dump files: r |
| 3 | ajschkdef | p | Execution agent profile | r |
| 4 | | e | Unit-attribute profile | r |
| 5 | | o | Output file | rw |
| 6 | ajscnvdbexport | b | Database backup file storage directory | rwX |
| 7 | ajscnvdbimport | b | Database backup file storage directory | rx |
| 8 | ajsembdbaddarea | d | Directory where the database area to be expanded is stored | rwX |
| 9 | ajsembdbaddlog | d | Directory where an area to be expanded is stored | rwX |
| 10 | | du | Directory where an area to be expanded is stored (duplicated) | rwX |
| 11 | ajsembdbbackup | i | Embedded database practical directory | rwX |
| 12 | | d | Data area | rw |
| 13 | | b | Backup file storage directory | rwX |
| 14 | ajsembdbbuild | d | Data area directory | rwX |
| 15 | | ld | Work area directory | rwX |
| 16 | | i | Embedded database practical directory | rwX |
| 17 | | bl | Unload log file creation directory | rwX |
| 18 | | conf | Embedded database settings file | r |
| 19 | ajsembdbinstl | s | Storage directory for embedded database installation media | rx |
| 20 | | i | Embedded database practical directory | rwX |
| 21 | ajsembdboplog | o | Output destination file | rw |
| 22 | ajsembdborg | d | Unload file storage directory | rwX |
| 23 | ajsembdbstr | i | Embedded database practical directory | rwX |
| 24 | | d | Data area | rw |

| No. | Command | Option | File or directory requiring access permissions | Required permissions for the AJS administrator |
|-----|-----------------------|--------|--|--|
| 25 | ajsembdbrstr | bf | Backup file | r |
| 26 | | l | Unload log file | r |
| 27 | | ld | Unload log storage directory | rx |
| 28 | | e | Directory where output results stored | rwX |
| 29 | ajsembdbunset | i | Embedded database practical directory | rwX |
| 30 | ajjs_migrate | T | Work directory | rwX |
| 31 | ajjs_rpenvexport | d | Output directory | rwX |
| 32 | ajjs_rpenvimport | d | Input directory | rx |
| 33 | ajjs_setup | d | Database directory | rwX |
| 34 | | t | Temporary directory | rwX |
| 35 | | j | Job information directory | rwX |
| 36 | | b | Backup information directory | rwX |
| 37 | | D | Logical host shared directory | rwX |
| 38 | ajjs_setup_cluster | d | Shared directory | rwX |
| 39 | | C | Embedded database settings file | r |
| 40 | jp1ajs2_setup_cluster | d | Shared directory | rwX |
| 41 | jpqdbcond | d | Work file directory | rwX |
| 42 | jpqexport | co | File to which the job execution environment is output | rw |
| 43 | | dp | Database storage directory | Rx |
| 44 | jpqimport | ci | Configuration definition file for the submit job execution environment | R |
| 45 | | dp | Database storage directory | rwX |
| 46 | ajjs_dbbackup | o | Backup data storage directory | rwX |
| 47 | ajjs_dbrestore | i | Backup data | rwX |

Legend

-: Not applicable

D. Unit Information that Can Be Acquired by the API

This appendix describes the unit information that can be acquired by the API.

D.1 List of members of the status monitoring resource that can be acquired by the API

The following table lists the members of the status monitoring resource that can be acquired by the API.

Table D–1: Members of the status monitoring resource that can be acquired by the API

| No. | Member | Acquired information | Unit list acquisition API | Unit information acquisition API | Default value if information cannot be acquired |
|-----|------------|------------------------------------|---------------------------|----------------------------------|---|
| 1 | definition | Unit definition information object | Yes | Yes | -- |
| 2 | unitStatus | Status information object | Yes ^{#1} | Yes | null |
| 3 | release | Release information | Yes ^{#2} | Yes ^{#2} | null |

Legend:

Yes: Information can be acquired.

#1

The API returns the default value without acquiring information in the following cases:

- The unit is not registered yet.
- **Definition** is specified for the range of information to be acquired.

#2

If the unit has not been registered for release, the API returns the default value without acquiring information.

D.2 List of members of the unit definition information object that can be acquired by the API

The following table lists the members of the unit definition information object that can be acquired by the API.

Table D–2: Members of the unit definition information object that can be acquired by the API

| No. | Member | Acquired information | Unit list acquisition API | Unit information acquisition API | Default value if information cannot be acquired |
|-----|----------------|-----------------------|---------------------------|----------------------------------|---|
| 1 | unitName | Full name of the unit | Yes | Yes | "" (null character) |
| 2 | simpleUnitName | Unit name | Yes | Yes | "" (null character) |
| 3 | unitComment | Comment for the unit | Yes | Yes | "" (null character) |
| 4 | unitType | Unit type | Yes | Yes | "NONE" |

| No. | Member | Acquired information | Unit list acquisition API | Unit information acquisition API | Default value if information cannot be acquired |
|-----|--------------------|---|---------------------------|----------------------------------|---|
| 5 | customJobType | Type of the custom job | Yes | Yes | "" (null character) |
| 6 | owner | Owner | Yes | Yes | "" (null character) |
| 7 | jp1ResourceGroup | JP1 resource group name | Yes | Yes | "" (null character) |
| 8 | execAgent | Execution agent name | Yes | Yes | "" (null character) |
| 9 | execFileName | Execution file name or script file name | Yes | Yes | "" (null character) |
| 10 | parameters | Parameters | Yes | Yes | "" (null character) |
| 11 | registerStatus | Registration status of the unit | Yes [#] | Yes | "NONE" |
| 12 | unitID | Unit ID | Yes | Yes | -1 |
| 13 | recoveryUnit | Whether the unit is a recovery unit | Yes | Yes | false |
| 14 | jobnetReleaseUnit | Whether release entry has been performed for the unit | Yes | Yes | false |
| 15 | wait | Whether the unit is a unit with wait condition | Yes | Yes | false |
| 16 | rootJobnetName | Full name of the unit of the root jobnet | Yes | Yes | "" (null character) |
| 17 | customEventJobType | Type of the custom event job | Yes | Yes | "" (null character) |

Legend:

Yes: Information can be acquired.

No: Information cannot be acquired, and the default value is returned.

#

If **Definition** is specified for the range of information to be acquired, the API returns the default value without acquiring information.

D.3 List of members of the status information object that can be acquired by the API

The following table lists the members of the status information object that can be acquired by the API.

Table D-3: Members of the status information object that can be acquired by the API

| No. | Member | Acquired information | Unit list acquisition API | Unit information acquisition API | Default value if information cannot be acquired |
|-----|----------------------|--|---------------------------|----------------------------------|---|
| 1 | unitName | Full name of the unit | Yes | Yes | "" (null character) |
| 2 | simpleUnitName | Unit name | Yes | Yes | "" (null character) |
| 3 | execID | Execution ID | Yes | Yes | "" (null character) |
| 4 | status | Unit status | Yes | Yes | "NONE" |
| 5 | schStartTime | Scheduled start time | Yes | Yes | "" (null character) |
| 6 | startTime | Start time | Yes | Yes | "" (null character) |
| 7 | reStartTime | Rerun start time | Yes | Yes | "" (null character) |
| 8 | endTime | End time | Yes | Yes | "" (null character) |
| 9 | startDelayStatus | Whether the start was delayed | Yes | Yes | "NONE" |
| 10 | nestStartDelayStatus | Whether the start of subordinate units was delayed | Yes | Yes | "NONE" |
| 11 | endDelayStatus | Whether the end was delayed | Yes | Yes | "NONE" |
| 12 | nestEndDelayStatus | Whether the end of subordinate units was delayed | Yes | Yes | "NONE" |
| 13 | startDelayTime | Time when the start was delayed | Yes | Yes | "" (null character) |
| 14 | endDelayTime | Time when the end was delayed | Yes | Yes | "" (null character) |
| 15 | changeType | Whether the plan has been changed temporarily | Yes | Yes | "NONE" |
| 16 | holdAttr | Hold attribute | Yes | Yes | "NONE" |
| 17 | registerTime | Time when the job is registered | Yes | Yes | "" (null character) |
| 18 | jobNumber | Job number | Yes | Yes | -1 |
| 19 | retCode | Return code | Yes | Yes | "" (null character) |
| 20 | execHost | Execution host name | Yes | Yes | "" (null character) |

| No. | Member | Acquired information | Unit list acquisition API | Unit information acquisition API | Default value if information cannot be acquired |
|-----|--------------------------|---|---------------------------|----------------------------------|---|
| 21 | delayedStart | Method of monitoring start delays | No | Yes [#] | "NONE" |
| 22 | delayedStartTime | Time to start monitoring of start delays | No | Yes [#] | "NONE" |
| 23 | delayedEnd | Method of monitoring end delays | No | Yes [#] | -1 |
| 24 | delayedEndTime | Time to start monitoring of end delays | No | Yes [#] | " " (null character) |
| 25 | monitoringJobnet | Method of monitoring end delays based on the time required for jobnet execution | No | Yes [#] | "NONE" |
| 26 | timeRequiredForExecution | Time required for jobnet execution | No | Yes [#] | ["NONE"] |

Legend:

Yes: Information can be acquired.

No: Information cannot be acquired, and the default value is returned.

#

If the unit is anything other than a jobnet (including a nested jobnet) or a remote jobnet, the API returns the default value without acquiring information.

D.4 List of members of the release information object that can be acquired by the API

The following table lists the members of the release information object that can be acquired by the API.

Table D–4: Members of the release information object that can be acquired by the API

| No. | Member | Acquired information | Unit list acquisition API | Unit information acquisition API | Default value if information cannot be acquired |
|-----|---------------|----------------------|---------------------------|----------------------------------|---|
| 1 | releaseID | Release ID | Yes | Yes | " " (null character) |
| 2 | releaseTime | Release time | Yes | Yes | " " (null character) |
| 3 | releaseStatus | Release status | Yes | Yes | "NONE" |

Legend:

Yes: Information can be acquired.

No: Information cannot be acquired, and the default value is returned.

E. Version Revisions

For details on the version revisions, see *B. Version Revisions* in the manual *JP1/Automatic Job Management System 3 Overview*.

F. Reference Material for This Manual

For details on reference information that would be helpful in reading this manual, see *C. Reference Material for This Manual* in the manual *JP1/Automatic Job Management System 3 Overview*.

G. Glossary

For the glossary, see *D. Glossary* in the manual *JP1/Automatic Job Management System 3 Overview*.

Index

Symbols

_04.bat (Windows only) 705
_04 (UNIX only) 692

A

ab (start condition definition) 1044
abr (flexible job definition) 1032
abr (HTTP Connection job definition) 1039
abr (QUEUE job definition) 964
abr (UNIX/PC custom job definition) 1022
abr (UNIX/PC job definition) 958
adding new administrator for embedded database or
changing existing administrator 1250
ajs 183
ajs_adapter_setup 71
AJS_AJSCONF 39
ajs2collectcore (UNIX only) 187
ajsagtadd 193
ajsagtalt 202
ajsagtcheck 209
ajsagt-del 212
ajsagtprint 216
ajsagtshow 220
ajsalter 229
ajsatmstart (Linux only) 232
ajsatmstop (Linux only) 233
ajsatsetup 72
ajsatstart (Linux only) 234
ajsatstatus (Linux only) 235
ajsatstop (Linux only) 236
AJSAUTOJUDGE 36
ajsbackup 237
ajsbkudel 241
ajscalendar 243
ajscalutil 250
ajschange 262
ajschgjob 279
ajschgnet 317
ajschgstat 332
ajschkdef 338
ajschksetup 75
ajschkstart (UNIX only) 349
ajschkstop (UNIX only) 351
ajschktrsetsz 353
ajscnvdbexport 78
ajscnvdbimport 80
AJSCONF 36
AJSCONVERTUTF8 37
ajscopy 354
ajsdefine 359
ajsdelete 363
AJSDISPSUBUNITTYPE 36
ajsembdbaddarea 366
ajsembdbaddlog 370
ajsembdbadduser 1254
ajsembdbbackup 374
ajsembdbbuild 82
ajsembdbcancel 380
ajsembdbidlist 94
ajsembdbinstl 100
ajsembdboplog 383
ajsembdbreclaim 389
ajsembdbreuse 1257
ajsembdbrogr 395
ajsembdbrstr 399
ajsembdbsetup 103
ajsembdbstart 406
ajsembdbstatus 409
ajsembdbstop 446
ajsembdbuninstl 110
ajsembdbunset 112
ajsenry 449
AJSENV 38
AJSEXDATE 39
AJSEXECID 39
AJSEXECPID 39
ajsexport 456
ajsfxbcstatus 458
ajsgtroot 460
AJSHOST 39
ajsimport 462
ajsintrpt 464
AJSJOBNAME 39
ajskill 467
ajsleave 471
ajslocaldate 807
ajslogprint 477
AJSMANAGERHOST 36
ajsname 481

AJSNETNAME 39
 AJSPATH 36
 ajsplan 484
 ajsplanout 497
 AJSPRE_RC 39
 AJSPRE_ST 38
 ajsprint 501
 ajsprofalter 540
 ajsprofstatus 543
 ajsqalalter 810
 ajsqlattach 813
 ajsqldetach 815
 ajsqlexecsetsz 817
 ajsqlftpstart (UNIX only) 819
 ajsqlftpstop 820
 AJSQManagerName (Windows only) 40
 ajsqlsetup 822
 ajsqlstart (UNIX only) 827
 ajsqlstatus 828
 ajsqlstop 831
 ajsqltrsetsz 833
 ajsrelease 546
 ajsreport 560
 ajsrerun 554
 ajsrestore 575
 ajsrgexport 579
 ajsrgimport 582
 ajschedule 586
 ajssetup 115
 ajsshow 589
 ajsstart 631
 ajsstatus 635
 ajsstop 649
 ajsuspend 655
 ajssysctlsetup 117
 ajssysctlstart (UNIX only) 658
 ajssysctlstatus 660
 ajssysctlstop (UNIX only) 665
 ajstrsetsz 667
 ajswebsetup 120
 ajswebtz.bat (Windows only) 671
 ajswebtz (Linux only) 669
 API
 API to change job transfer restriction status of execution agent 1172
 API to change job transfer restriction status of execution agent group 1191
 API to check communication status of job distribution delay reduction function 1177
 API to exclude or add, or change priority levels of execution agents 1194
 authentication 1068
 change delay monitor API 1124
 change hold attribute API 1122
 change job status API 1130
 change plan (change time) API 1133
 change plan (execute immediately) API 1139
 change plan (execution prohibited) API 1141
 change plan (release change) API 1143
 data type usable 1069
 detail 1089
 execution agent addition API 1164
 execution agent definition acquisition API 1161
 execution agent deletion API 1167
 execution agent group addition API 1184
 execution agent group definition acquisition API 1182
 execution agent group deletion API 1187
 execution agent group reconfiguration API 1189
 execution agent group status list acquisition API 1180
 execution agent reconfiguration API 1169
 execution agent status acquisition API 1159
 execution agent status change API 1175
 execution agent status list acquisition API 1157
 execution order control method change API 1155
 execution result details acquisition API 1099
 fixed execution registration API 1107
 immediate execution registration API 1115
 interrupt API 1146
 JP1/AJS3 - Manager protocol version acquisition API 1200
 kill API 1148
 list 1078
 note on using 1084
 planned execution registration API 1104
 registration cancellation API 1118
 rerun API 1150
 unit information acquisition API 1096
 unit list acquisition API 1089
 version information acquisition API 1197
 wait condition status list acquisition API 1101
 wait status change API 1153
 API to change job transfer restriction status of execution agent 1172
 API to change job transfer restriction status of execution agent group 1191

API to check communication status of job distribution
delay reduction function 1177
API to exclude or add, or change priority levels of
execution agents 1194
ar (jobnet definition) 952
argument 21
AS/400 system 35
attribute definition 939
authentication
 using API 1068

C

calculating estimated required time 614
cautionary notes
 when UTF-8 is used as character encoding 31
cd (jobnet definition) 951
cety (custom event job definition) 1041
cftd (jobnet definition) 949
cgs (start condition definition) 1044
change delay monitor API 1124
 constant 1239
ChangeExecOrderMethod 1242
ChangeHoldAttr 1237
change hold attribute API 1122
 constant 1237
change job status API 1130
 constant 1240
ChangeLowerType 1238
change plan (change time) API 1133
change plan (execute immediately) API 1139
change plan (execution prohibited) API 1141
change plan (release change) API 1143
change plan API
 constant 1237
ChangePushedAheadType 1237
ChangeStartTimeType 1237
ChangeStatus 1240
ChangeType 1233
changing options of tables in embedded database 1251
cl (job group definition) 943
cm (attribute definition) 941
cmaif (OpenView Status Report job definition) 1012
cmsts (OpenView Status Report job definition) 1011
commands 43
commands used during special operation
 commands available during operation test 62

 commands available in execution environment for
 queue or submit jobs 58
 commands available when queueless jobs are used
 61
commands used to control JP1/AJS3 46
commands used to customize environments 45
commands used to execute jobs 55
commands used to manipulate the embedded
database 55
commands used to manipulate units 49
commands used to operate execution agents 54
commands used to set up JP1/AJS3 43
commands used when error occurs 57
commands you can execute remotely and how to
execute them 27
command used to manipulate the external database 56
ComStatus 1242
cond (start condition definition) 1044
ConnectInfoType 1242
constant
 commonly used by API 1225
 used by unit change delay monitor API 1239
 used by change hold attribute API 1237
 used by change job status API 1240
 used by change plan API 1237
 used by execution order control method change API
 1242
 used by execution registration API 1231
 used by release information object 1236
 used by rerun API 1238
 used by start condition parameter object 1236
 used by status information object 1233
 used by unit definition information object 1232
 used by unit list acquisition API 1227
 used for execution agent objects 1241
 used for waiting 1240
cprm (custom event job definition) 1043
creating a unit definition file 935
cty (passing information setting job definition) 1028
cty (UNIX/PC custom job definition) 1019
Custom event job definition 1041
cy (jobnet definition) 948

D

da (flexible job definition) 1030
data type
 usable for API 1069
DateType 1225

de (jobnet definition) 951
defining the configuration definition file for the submit
job execution environment (jppqsetup.conf) 869
DelayEnd 1226
DelayMonitor 1235
DelayMonitorType 1239
DelayStart 1226
DelayType 1231
detail
 API 1089
 object 1208
 resource 1203

E

ed (jobnet definition) 949
ega (custom event job definition) 1043
ega (email reception monitoring job definition) 981
ega (email sending job definition) 1004
ega (execution-interval control job definition) 997
ega (file monitoring job definition) 978
ega (flexible job definition) 1033
ega (HTTP Connection job definition) 1040
ega (job definition for monitoring JP1 event reception)
975
ega (job definition for monitoring message-queue
message reception) 984
ega (jobnet connector definition) 1046
ega (jobnet definition) 953
ega (JP1 event sending job definition) 1000
ega (local power control job definition) 1015
ega (log-file monitoring job definition) 990
ega (message-queue message sending job definition)
1007
ega (MSMQ message reception monitoring job
definition) 987
ega (MSMQ message sending job definition) 1011
ega (OpenView Status Report job definition) 1013
ega (passing information setting job definition) 1029
ega (QUEUE job definition) 967
ega (remote power control job definition) 1018
ega (UNIX/PC custom job definition) 1027
ega (UNIX/PC job definition) 962
ega (Windows event-log monitoring job definition) 994
ej (judgment job definition) 967
ejc (judgment job definition) 968
ejf (judgment job definition) 969
ejg (judgment job definition) 970
ejh (judgment job definition) 969

ejj (judgment job definition) 970
ejl (judgment job definition) 969
ejm (judgment job definition) 970
ejn (jobnet definition) 950
ejs (judgment job definition) 970
ejt (judgment job definition) 969
eju (judgment job definition) 970
ejv (judgment job definition) 969
el (unit configuration definition) 941
email reception monitoring job definition 978
email sending job definition 1001
embedded database
 adding new administrator or changing existing
 administrator 1250
 changing options of tables 1251
embedded-database commands
 notes on using 1249
env (flexible job definition) 1031
env (passing information setting job definition) 1028
env (UNIX/PC custom job definition) 1021
env (UNIX/PC job definition) 956
environment variables 36
environment variables for command execution 28
environment variables set for job execution 38
environment variables set when a job is executed from
JP1/AJS3 38
environment variables used for command execution 36
environment variables used to execute JP1/AJS3
commands 36
etm 983
etm (custom event job definition) 1041
etm (email reception monitoring job definition) 980
etm (email sending job definition) 1003
etm (execution-interval control job definitionA) 996
etm (file monitoring job definition) 976
etm (HTTP Connection job definition) 1038
etm (job definition for monitoring JP1 event reception)
973
etm (JP1 event sending job definition) 998
etm (local power control job definition) 1014
etm (log-file monitoring job definition) 989
etm (message-queue message sending job definition)
1006
etm (MSMQ message reception monitoring job
definition) 986
etm (MSMQ message sending job definition) 1010
etm (OpenView Status Report job definition) 1012
etm (remote power control job definition) 1017

etm (UNIX/PC custom job definition) 1021
 etm (UNIX/PC job definition) 957
 etm (Windows event-log monitoring job definition) 993
 etn (execution-interval control job definition) 995
 ets (custom event job definition) 1042
 ets (email reception monitoring job definition) 981
 ets (execution-interval control job definition) 996
 ets (file monitoring job definition) 977
 ets (job definition for monitoring JP1 event reception) 974
 ets (job definition for monitoring message-queue message reception) 983
 ets (log-file monitoring job definition) 990
 ets (MSMQ message reception monitoring job definition) 986
 ets (Windows event-log monitoring job definition) 994
 eu 983
 eu (custom event job definition) 1042
 eu (email reception monitoring job definition) 981
 eu (email sending job definition) 1004
 eu (execution-interval control job definition) 996
 eu (file monitoring job definition) 977
 eu (flexible job definition) 1033
 eu (HTTP Connection job definition) 1040
 eu (job definition for monitoring JP1 event reception) 974
 eu (JP1 event sending job definition) 999
 eu (local power control job definition) 1015
 eu (log-file monitoring job definition) 990
 eu (message-queue message sending job definition) 1007
 eu (MSMQ message reception monitoring job definition) 986
 eu (MSMQ message sending job definition) 1010
 eu (OpenView Status Report job definition) 1012
 eu (QUEUE job definition) 966
 eu (remote power control job definition) 1018
 eu (UNIX/PC custom job definition) 1023
 eu (UNIX/PC job definition) 961
 eu (Windows event-log monitoring job definition) 994
 eun (custom event job definition) 1042
 eun (email reception monitoring job definition) 981
 eun (email sending job definition) 1004
 eun (execution-interval control job definition) 997
 eun (file monitoring job definition) 977
 eun (flexible job definition) 1033
 eun (HTTP Connection job definition) 1040
 eun (job definition for monitoring JP1 event reception) 974
 eun (job definition for monitoring message-queue message reception) 984
 eun (jobnet connector definition) 1046
 eun (jobnet definition) 953
 eun (JP1 event sending job definition) 1000
 eun (local power control job definition) 1015
 eun (log-file monitoring job definition) 990
 eun (message-queue message sending job definition) 1007
 eun (MSMQ message reception monitoring job definition) 987
 eun (MSMQ message sending job definition) 1011
 eun (OpenView Status Report job definition) 1013
 eun (passing information setting job definition) 1029
 eun (QUEUE job definition) 966
 eun (remote power control job definition) 1018
 eun (UNIX/PC custom job definition) 1027
 eun (UNIX/PC job definition) 962
 eun (Windows event-log monitoring job definition) 994
 ev (UNIX/PC custom job definition) 1023
 ev (UNIX/PC job definition) 956
 evdet (job definition for monitoring JP1 event reception) 972
 evesc (job definition for monitoring JP1 event reception) 974
 evgid (job definition for monitoring JP1 event reception) 973
 evgrp (job definition for monitoring JP1 event reception) 971
 evhst (job definition for monitoring JP1 event reception) 972
 evhst (JP1 event sending job definition) 998
 evipa (job definition for monitoring JP1 event reception) 972
 evpid (job definition for monitoring JP1 event reception) 973
 evsfr (JP1 event sending job definition) 998
 evsid (JP1 event sending job definition) 998
 evsms (JP1 event sending job definition) 998
 evspl (JP1 event sending job definition) 999
 evsrc (JP1 event sending job definition) 999
 evsrt (JP1 event sending job definition) 999
 evssv (JP1 event sending job definition) 998
 evtmc (job definition for monitoring JP1 event reception) 973
 evuid (job definition for monitoring JP1 event reception) 973

evusr (job definition for monitoring JP1 event reception) 971
 evwfr (job definition for monitoring JP1 event reception) 972
 evwid (job definition for monitoring JP1 event reception) 971
 evwms (job definition for monitoring JP1 event reception) 972
 evwsv (job definition for monitoring JP1 event reception) 972
 ex 983
 ex (custom event job definition) 1042
 ex (email reception monitoring job definition) 981
 ex (email sending job definition) 1003
 ex (execution-interval control job definition) 996
 ex (file monitoring job definition) 977
 ex (flexible job definition) 1030
 ex (HTTP Connection job definition) 1038
 ex (job definition for monitoring JP1 event reception) 973
 ex (jobnet definition) 951
 ex (JP1 event sending job definition) 999
 ex (local power control job definition) 1014
 ex (log-file monitoring job definition) 990
 ex (message-queue message sending job definition) 1006
 ex (MSMQ message reception monitoring job definition) 986
 ex (MSMQ message sending job definition) 1010
 ex (OpenView Status Report job definition) 1012
 ex (remote power control job definition) 1017
 ex (UNIX/PC custom job definition) 1022
 ex (UNIX/PC job definition) 957
 ex (Windows a event-log monitoring job definition) 994
 example of a schedule information parameter 1057
 examples of specifying unit definition parameters 1047
 ExecAgentStatus 1241
 ExecOrderMethod 1236
 execution agent addition API 1164
 execution agent definition acquisition API 1161
 execution agent definition information object 1221
 execution agent deletion API 1167
 execution agent group addition API 1184
 execution agent group definition acquisition API 1182
 execution agent group deletion API 1187
 execution agent group reconfiguration API 1189
 execution agent group status list acquisition API 1180
 execution agent object

constant 1241
 execution agent operation result object 1219
 execution agent reconfiguration API 1169
 execution agent status acquisition API 1159
 execution agent status change API 1175
 execution agent status list acquisition API 1157
 execution agent status object 1222
 execution ID 23
 execution-interval control job definition 995
 execution order control method change API 1155
 constant 1242
 execution registration API
 constant 1231
 execution result details acquisition API 1099
 ey (jobnet definition) 947

F

fd (custom event job definition) 1042
 fd (email reception monitoring job definition) 980
 fd (email sending job definition) 1003
 fd (execution-interval control job definitionA) 996
 fd (file monitoring job definition) 976
 fd (HTTP Connection job definition) 1038
 fd (job definition for monitoring JP1 event reception) 973
 fd (job definition for monitoring message-queue message reception) 983
 fd (jobnet definition) 952
 fd (JP1 event sending job definition) 999
 fd (local power control job definition) 1014
 fd (log-file monitoring job definition) 989
 fd (message-queue message sending job definition) 1006
 fd (MSMQ message reception monitoring job definition) 986
 fd (MSMQ message sending job definition) 1010
 fd (OpenView Status Report job definition) 1012
 fd (QUEUE job definition) 964
 fd (remote power control job definition) 1017
 fd (UNIX/PC custom job definition) 1021
 fd (UNIX/PC job definition) 957
 fd (Windows event-log monitoring job definition) 993
 file monitoring job definition 975
 fixed execution registration API 1107
 flco (file monitoring job definition) 976
 flexible job definition 1029
 flwc (file monitoring job definition) 976

flwf (file monitoring job definition) 976
flwi (file monitoring job definition) 976
forced termination (kill) of jobs 652
forced termination (kill) of the scheduler service 652
format of unit definition files 935
full name 22
fxg (flexible job definition) 1030

G

GenerationType 1229
gty (job group definition) 944

H

ha 983
ha (custom event job definition) 1042
ha (email reception monitoring job definition) 981
ha (email sending job definition) 1003
ha (execution-interval control job definition) 996
ha (file monitoring job definition) 977
ha (flexible job definition) 1033
ha (HTTP Connection job definition) 1040
ha (job definition for monitoring JP1 event reception) 974
ha (jobnet definition) 950
ha (JP1 event sending job definition) 999
ha (judgment job definition) 970
ha (local power control job definition) 1014
ha (log-file monitoring job definition) 990
ha (message-queue message sending job definition) 1007
ha (MSMQ message reception monitoring job definition) 986
ha (MSMQ message sending job definition) 1010
ha (OpenView Status Report job definition) 1012
ha (QUEUE job definition) 966
ha (remote power control job definition) 1017
ha (UNIX/PC custom job definition) 1023
ha (UNIX/PC job definition) 961
ha (Windows event-log monitoring job definition) 994
HoldAttr 1234
HoldPlan 1231
HOME (UNIX only) 40
how to specify the name of a unit in a planning group 494
htcdm (HTTP Connection job definition) 1037
htcfl (HTTP Connection job definition) 1034
htexm (HTTP Connection job definition) 1035

htknd (HTTP Connection job definition) 1035
htrbf (HTTP Connection job definition) 1037
htrhf (HTTP Connection job definition) 1036
htrqf (HTTP Connection job definition) 1035
htrqm (HTTP Connection job definition) 1036
htrqu (HTTP Connection job definition) 1035
htspt (HTTP Connection job definition) 1036
htstf (HTTP Connection job definition) 1036
HTTP connection job definition 1034

I

immediate execution registration API 1115
interrupt API 1146

J

jajs_config 123
jajs_dbbackup 673
jajs_dbrestore 677
jajs_extdb 681
jajs_hstd 686
jajs_hstd_stop 688
jajs_killall.cluster (UNIX only) 690
jajs_log.bat (Windows only) 705
jajs_log (UNIX only) 692
jajs_maintain 58, 835
jajs_migrate 126
jajs_pmtcon 718
jajs_rpenvexport 133
jajs_rpenvimport 136
jajs_rpsite 140
jajs_setup 145
jajs_setup_cluster 162
jajs_spmd 722
jajs_spmd_status 727
jajs_spmd_stop 733
jajs_start.cluster (UNIX only) 739
jajs_start (UNIX only) 737
jajs_status 742
jajs_stop.cluster (UNIX only) 756
jajs_stop (UNIX only) 754
jajs_web_stop (Linux only) 760
jajs_web (Linux only) 758
jajsacfg (Windows only) 840
jajsshowadminusr (UNIX only) 721
jc (jobnet definition) 951
jd (flexible job definition) 1031

jd (HTTP Connection job definition) 1038
 jd (QUEUE job definition) 964
 jd (UNIX/PC custom job definition) 1022
 jd (UNIX/PC job definition) 958
 jdf (flexible job definition) 1032
 jdf (HTTP Connection job definition) 1039
 jdf (UNIX/PC custom job definition) 1022
 jdf (UNIX/PC job definition) 958
 job definition for monitoring JP1 event reception 971
 job definition for monitoring message-queue message reception 982
 job group definition 942
 jobnet connector
 specifying definition 1044
 jobnet definition 945
 jobnet restriction 651
 job restriction 651
 JP1_HOSTNAME 36, 39
 JP1_USERNAME 36, 39
 JP1/AJS3 - Manager protocol version acquisition API 1200
 JP1 event sending job definition 997
 jp1exec (Windows only) 761
 jp1exit (Windows only) 764
 JP1JobID 39
 JP1JobName 39
 JP1NBQSClientName (Windows only) 39
 JP1NBQSQueueName 39
 JP1Priority 40
 JP1UNCName 39
 JP1UserName 39
 jpoagoec 766
 jpoagtjobshow 769
 jpoif (custom event job definition) 1041
 jpoif (email reception monitoring job definition) 980
 jpoif (execution-interval control job definition) 996
 jpoif (file monitoring job definition) 976
 jpoif (job definition for monitoring JP1 event reception) 973
 jpoif (job definition for monitoring message-queue message reception) 983
 jpoif (log-file monitoring job definition) 989
 jpoif (MSMQ message reception monitoring job definition) 985
 jpoif (Windows event-log monitoring job definition) 993
 jpomailprof (Windows only) 773
 jpomailrcv (UNIX only) 174
 jpomanevreset 782
 jpomanevshow 790
 jpomanjobshow 794
 jpqagtadd 60, 841
 jpqagtalt 60, 844
 jpqagtdel 60, 847
 jpqagmlink 60, 850
 jpqagtshow 60, 853
 jpqagtunlink 60, 857
 jpqdbcond 798
 jpqendjobshow 59, 859
 jpqexport 58, 864
 jpqimport 58, 866
 jpqjobalt 58, 874
 jpqjobcan 58, 877
 jpqjobdel 59, 880
 jpqjobget 58, 882
 jpqjobmove 58, 888
 jpqjobshow 59, 892
 jpqjobsub 58, 896
 jpqqueadd 60, 906
 jpqquealt 60, 909
 jpqqueclose 59, 913
 jpqquedel 60, 916
 jpqqueopen 59, 918
 jpqqueshow 59, 921
 jpqregguestuser 176
 jpqreguser 178
 jpqresadd 61, 926
 jpqresdel 61, 928
 jpqresshow 61, 930
 jty (email sending job definition) 1004
 jty (JP1 event sending job definition) 999
 jty (local power control job definition) 1015
 jty (message-queue message sending job definition) 1007
 jty (MSMQ message sending job definition) 1010
 jty (OpenView Status Report job definition) 1012
 jty (remote power control job definition) 1018
 jty (UNIX/PC job definition) 961
 judgment job definition 967

K

kill API 1148

L

LANG 36

LANG (UNIX only) 40

LC_ALL 37

lfcre (log-file monitoring job definition) 989

lfdfd (log-file monitoring job definition) 988

lffnm (log-file monitoring job definition) 988

lfhds (log-file monitoring job definition) 988

lfmks (log-file monitoring job definition) 989

lfmxi (log-file monitoring job definition) 989

lfrft (log-file monitoring job definition) 988

lfsiv (log-file monitoring job definition) 989

lfsrc (log-file monitoring job definition) 989

lftpd (log-file monitoring job definition) 988

limit values when linking with AS/400 (JP1/OJE for Midrange Computer) 35

limit values when linking with JP1/OJE for VOS3 34

linkage with AS/400 (JP1/OJE for Midrange Computer) 35

linkage with other programs 34

list of APIs 1078

list of objects 1081

list of resources 1080

ln (jobnet definition) 948

local power control job definition 1013

Log-file monitoring job definition 987

logical host name 22

LONGNAME (UNIX only) 40

LowerType 1227

M

macro variable object 1218

MAIL (UNIX only) 40

manager unit definition 954

MatchMethods 1227

mcs (start condition definition) 1044

md (job group definition) 943

message-queue message sending job definition 1005

mh (manager unit definition) 954

mladr (email reception monitoring job definition) 979

mladr (email sending job definition) 1001

mlafl (email reception monitoring job definition) 980

mlafl (email sending job definition) 1003

mlatf (email sending job definition) 1003

mlftx (email sending job definition) 1003

mllst (email reception monitoring job definition) 980

mlprf (email reception monitoring job definition) 979

mlprf (email sending job definition) 1002

mlsav (email reception monitoring job definition) 980

mlsbn (email reception monitoring job definition) 979

mlsbn (email sending job definition) 1002

mlsfd (email reception monitoring job definition) 980

mlstx (email reception monitoring job definition) 980

mltxt (email reception monitoring job definition) 979

mltxt (email sending job definition) 1002

mm (custom event job definition) 1042

mm (email reception monitoring job definition) 981

mm (email sending job definition) 1004

mm (execution-interval control job definition) 996

mm (file monitoring job definition) 977

mm (flexible job definition) 1033

mm (HTTP Connection job definition) 1040

mm (job definition for monitoring JP1 event reception) 974

mm (job definition for monitoring message-queue message reception) 984

mm (jobnet connector definition) 1045

mm (jobnet definition) 953

mm (JP1 event sending job definition) 999

mm (local power control job definition) 1015

mm (log-file monitoring job definition) 990

mm (message-queue message sending job definition) 1007

mm (MSMQ message reception monitoring job definition) 986

mm (MSMQ message sending job definition) 1010

mm (OpenView Status Report job definition) 1013

mm (passing information setting job definition) 1029

mm (QUEUE job definition) 966

mm (remote power control job definition) 1018

mm (UNIX/PC custom job definition) 1027

mm (UNIX/PC job definition) 961

mm (Windows event-log monitoring job definition) 994

MonitoringJobnet 1235

MonitoringJobnetType 1239

mp (jobnet definition) 951

mqqor (job definition for monitoring message-queue message reception) 982

mqqor (message-queue message sending job definition) 1005

mqdsc (job definition for monitoring message-queue message reception) 982

mqdsc (message-queue message sending job definition) 1005

mqqqn (message-queue message sending job definition) 1006

mqqhd (message-queue message sending job definition) 1006

mqmdl (job definition for monitoring message-queue message reception) 983

mqmdl (message-queue message sending job definition) 1006

mqmdn 1006

mqmfn (message-queue message sending job definition) 1006

mqmgr (message-queue message sending job definition) 1005

mqpgm (message-queue message sending job definition) 1006

mqpri (message-queue message sending job definition) 1006

mqprm (message-queue message sending job definition) 1005

mqque (job definition for monitoring message-queue message reception) 982

mqque (message-queue message sending job definition) 1005

mqsfm (job definition for monitoring message-queue message reception) 983

ms (jobnet definition) 951

msapl (MSMQ message reception monitoring job definition) 985

msapl (MSMQ message sending job definition) 1010

mshld (MSMQ message sending job definition) 1009

msjnl (MSMQ message sending job definition) 1009

mslbl (MSMQ message reception monitoring job definition) 985

mslbl (MSMQ message sending job definition) 1009

mslmt (MSMQ message sending job definition) 1009

msmod (MSMQ message sending job definition) 1009

MSMQ message reception monitoring job definition 984

MSMQ message sending job definition 1008

mspri (MSMQ message sending job definition) 1009

msqlb (MSMQ message sending job definition) 1008

msqpt (MSMQ message reception monitoring job definition) 985

msqpt (MSMQ message sending job definition) 1008

msrer (MSMQ message reception monitoring job definition) 985

msrer (MSMQ message sending job definition) 1009

mssvf (MSMQ message reception monitoring job definition) 985

mstfn (MSMQ message sending job definition) 1009

msttp (MSMQ message sending job definition) 1009

msunr (MSMQ message sending job definition) 1009

mu (manager unit definition) 954

N

ncex (job group definition) 944

ncex (jobnet connector definition) 1045

ncex (jobnet definition) 952

nchn (job group definition) 944

nchn (jobnet connector definition) 1045

nchn (jobnet definition) 953

ncl (job group definition) 944

ncl (jobnet definition) 952

ncn (job group definition) 944

ncn (jobnet definition) 952

ncr (jobnet connector definition) 1045

ncs (job group definition) 944

ncs (jobnet definition) 952

ncsv (job group definition) 945

ncsv (jobnet connector definition) 1045

ncsv (jobnet definition) 953

ni (jobnet definition) 950

nmg (custom event job definition) 1042

nmg (email reception monitoring job definition) 981

nmg (email sending job definition) 1004

nmg (execution-interval control job definition) 997

nmg (file monitoring job definition) 977

nmg (flexible job definition) 1033

nmg (HTTP Connection job definition) 1040

nmg (job definition for monitoring JP1 event reception) 974

nmg (job definition for monitoring message-queue message reception) 984

nmg (jobnet connector definition) 1045

nmg (jobnet definition) 953

nmg (JP1 event sending job definition) 1000

nmg (local power control job definition) 1015

nmg (log-file monitoring job definition) 990

nmg (message-queue message sending job definition) 1007

nmg (MSMQ message reception monitoring job definition) 986

nmg (MSMQ message sending job definition) 1010

nmg (OpenView Status Report job definition) 1013

nmg (passing information setting job definition) 1029

nmg (QUEUE job definition) 966

nmg (remote power control job definition) 1018

nmg (UNIX/PC custom job definition) 1027

nmg (UNIX/PC job definition) 962

nmg (Windows event-log monitoring job definition) 994

note on using API 1084

- notes common to all commands 30
- notes on commands related to the scheduler service 30
- notes on commands that consume a large amount of system resources 30
- notes on commands that perform mutually conflicting processes 30
- notes on operation in the console for executing commands 31
- notes on using commands 30
- ntcls (Windows event-log monitoring job definition) 993
- ntdis (Windows event-log monitoring job definition) 993
- nteid (Windows event-log monitoring job definition) 993
- ntevt (Windows event-log monitoring job definition) 992
- ntlgt (Windows event-log monitoring job definition) 992
- ntncl (Windows event-log monitoring job definition) 993
- ntnei (Windows event-log monitoring job definition) 993
- ntnsr (Windows event-log monitoring job definition) 992
- ntolg (Windows event-log monitoring job definition) 992
- ntsrc (Windows event-log monitoring job definition) 993

O

- object
 - detail 1208
 - execution agent definition information object 1221
 - execution agent operation result object 1219
 - execution agent status object 1222
 - list 1081
 - macro variable object 1218
 - release information object 1217
 - start condition parameter object 1217
 - status information object 1211
 - unit definition information object 1208
- op (jpb group definition) 942
- OpenView Status Report job definition 1011
- option 21

P

- Passing information setting job definition 1028
- PATH (UNIX only) 40
- pfm (email reception monitoring job definition) 978
- pfm (email sending job definition) 1003
- pfm (JP1 event sending job definition) 998
- pfm (local power control job definition) 1014
- pfm (message-queue message sending job definition) 1006
- pfm (OpenView Status Report job definition) 1012
- pfm (remote power control job definition) 1017

- planned execution registration API 1104
- PlannedTimePassedType 1231
- pr (HTTP Connection job definition) 1038
- pr (jobnet definition) 950
- pr (QUEUE job definition) 964
- pr (UNIX/PC custom job definition) 1021
- pr (UNIX/PC job definition) 957
- prerequisites to use commands 63
- privilege
 - required for operation as AJS administrator 1262
- prm (flexible job definition) 1031
- prm (passing information setting job definition) 1028
- prm (QUEUE job definition) 963
- prm (UNIX/PC custom job definition) 1021
- prm (UNIX/PC job definition) 955
- pwlf (local power control job definition) 1014
- pwlt (local power control job definition) 1014
- pwrf (remote power control job definition) 1016
- pwrh (remote power control job definition) 1016
- pwrn (remote power control job definition) 1016
- pwrp (remote power control job definition) 1017
- pwr (remote power control job definition) 1017
- pwrw (remote power control job definition) 1017

Q

- qm (QUEUE job definition) 963
- qu (QUEUE job definition) 963
- QUEUE job definition 962

R

- rec (flexible job definition) 1032
- rec (HTTP Connection job definition) 1040
- rec (QUEUE job definition) 965
- rec (UNIX/PC custom job definition) 1023
- rec (UNIX/PC job definition) 959
- RegisterStatus 1233
- registration cancellation API 1118
- regular expression
 - specification example 1228
 - symbol 1228
- rei (flexible job definition) 1033
- rei (HTTP Connection job definition) 1040
- rei (QUEUE job definition) 965
- rei (UNIX/PC custom job definition) 1023
- rei (UNIX/PC job definition) 959
- release information object 1217

- constant 1236
- ReleaseInfoSearchMethods 1231
- ReleaseStatus 1236
- remote execution of a command 27
- remote power control job definition 1016
- req (QUEUE job definition) 963
- request format 1071
- rerun API 1150
 - constant 1238
- RerunOption 1239
- RerunType 1238
- resource
 - detail 1203
 - for status monitoring 1203
 - list 1080
 - wait resource 1203
- response format 1074
- rg (jobnet definition) 950
- rh (jobnet definition) 951
- rje (flexible job definition) 1032
- rje (HTTP Connection job definition) 1039
- rje (QUEUE job definition) 964
- rje (UNIX/PC custom job definition) 1023
- rje (UNIX/PC job definition) 959
- rjs (flexible job definition) 1032
- rjs (HTTP Connection job definition) 1039
- rjs (QUEUE job definition) 964
- rjs (UNIX/PC custom job definition) 1023
- rjs (UNIX/PC job definition) 958
- RootRerunType 1238
- sh (jobnet definition) 948
- shd (jobnet definition) 948
- SHELL (UNIX only) 40
- si (UNIX/PC custom job definition) 1024
- si (UNIX/PC job definition) 956
- so (HTTP Connection job definition) 1037
- so (UNIX/PC custom job definition) 1021
- so (UNIX/PC job definition) 956
- soa (UNIX/PC custom job definition) 1024
- soa (UNIX/PC job definition) 957
- specifying
 - IPv6 address 26
- specifying a command 21
- specifying a unit name 22
- specifying a unit name in a command when using a planning group 23
- Specifying wildcard characters 26
- st (jobnet definition) 947
- start condition definition 1043
- start condition parameter object 1217
 - constant 1236
- Status 1225
- status information object 1211
 - constant 1233
- status monitoring
 - resource 1203
- stt (job group definition) 943
- sy (jobnet definition) 947
- symbol
 - that can be specified as regular expression 1228
- symbols used in command usage description 26
- sz (unit configuration definition) 942

S

- sc (flexible job definition) 1031
- sc (passing information setting job definition) 1028
- sc (QUEUE job definition) 963
- sc (UNIX/PC custom job definition) 1021
- sc (UNIX/PC job definition) 955
- schedule restriction 649
- scheduler service name 22
- sd (jobnet definition) 946
- sdd (job group definition) 943
- se (HTTP Connection job definition) 1037
- se (UNIX/PC custom job definition) 1021
- se (UNIX/PC job definition) 957
- sea (UNIX/PC custom job definition) 1024
- sea (UNIX/PC job definition) 957
- SearchTargetType 1227

T

- td1 (QUEUE job definition) 965
- td1 (UNIX/PC custom job definition) 1024
- td1 (UNIX/PC job definition) 959
- td2 (QUEUE job definition) 965
- td2 (UNIX/PC custom job definition) 1025
- td2 (UNIX/PC job definition) 960
- td3 (QUEUE job definition) 966
- td3 (UNIX/PC custom job definition) 1026
- td3 (UNIX/PC job definition) 960
- td4 (QUEUE job definition) 966
- td4 (UNIX/PC custom job definition) 1026
- td4 (UNIX/PC job definition) 961
- te (UNIX/PC custom job definition) 1020

te (UNIX/PC job definition) 955
 tho (flexible job definition) 1032
 tho (HTTP Connection job definition) 1039
 tho (passing information setting job definition) 1029
 tho (QUEUE job definition) 964
 tho (UNIX/PC custom job definition) 1022
 tho (UNIX/PC job definition) 958
 TimeType (start condition parameter object) 1236
 TimeType (status information object) 1234
 tmitv (execution-interval control job definition) 995
 top1 (UNIX/PC custom job definition) 1025
 top1 (UNIX/PC job definition) 959
 top2 (UNIX/PC custom job definition) 1025
 top2 (UNIX/PC job definition) 960
 top3 (UNIX/PC custom job definition) 1026
 top3 (UNIX/PC job definition) 960
 top4 (UNIX/PC custom job definition) 1027
 top4 (UNIX/PC job definition) 961
 ts1 (QUEUE job definition) 965
 ts1 (UNIX/PC custom job definition) 1024
 ts1 (UNIX/PC job definition) 959
 ts2 (QUEUE job definition) 965
 ts2 (UNIX/PC custom job definition) 1025
 ts2 (UNIX/PC job definition) 960
 ts3 (QUEUE job definition) 965
 ts3 (UNIX/PC custom job definition) 1025
 ts3 (UNIX/PC job definition) 960
 ts4 (QUEUE job definition) 966
 ts4 (UNIX/PC custom job definition) 1026
 ts4 (UNIX/PC job definition) 961
 ty (attribute definition) 939
 ty (passing information setting job definition) 1028
 Type 1232
 TZ 36

U

uem (custom event job definition) 1043
 uem (email reception monitoring job definition) 982
 uem (email sending job definition) 1004
 uem (execution-interval control job definition) 997
 uem (file monitoring job definition) 978
 uem (flexible job definition) 1033
 uem (HTTP Connection job definition) 1041
 uem (job definition for monitoring JP1 event reception) 975
 uem (job definition for monitoring message-queue message reception) 984

uem (jobnet connector definition) 1046
 uem (jobnet definition) 953
 uem (JP1 event sending job definition) 1000
 uem (local power control job definition) 1015
 uem (log-file monitoring job definition) 991
 uem (message-queue message sending job definition) 1007
 uem (MSMQ message reception monitoring job definition) 987
 uem (MSMQ message sending job definition) 1011
 uem (OpenView Status Report job definition) 1013
 uem (passing information setting job definition) 1029
 uem (QUEUE job definition) 967
 uem (remote power control job definition) 1018
 uem (UNIX/PC custom job definition) 1027
 uem (UNIX/PC job definition) 962
 uem (Windows event-log monitoring job definition) 995
 un (HTTP Connection job definition) 1038
 un (UNIX/PC custom job definition) 1022
 un (UNIX/PC job definition) 958
 unit configuration definition 941
 unit definition information object 1208
 constant 1232
 unit information acquisition API 1096
 unit list acquisition API 1089
 constant 1227
 unit name 22
 UnitStatus 1229
 UnitType 1228
 UNIX/PC custom job definition 1019
 UNIX/PC job definition 954

V

version information acquisition API 1197

W

wait condition status list acquisition API 1101
 waiting
 constant 1240
 Waiting 1235
 WaitingAction 1240
 WaitingStatus 1241
 WaitingStatusAction 1241
 WaitMethod 1240
 wait status change API 1153
 wc (jobnet definition) 949
 Windows event-log monitoring job definition 991

wkp (UNIX/PC custom job definition) 1023
wkp (UNIX/PC job definition) 956
wt (jobnet definition) 948
wth (flexible job definition) 1032
wth (HTTP Connection job definition) 1039
wth (passing information setting job definition) 1028
wth (QUEUE job definition) 964
wth (UNIX/PC custom job definition) 1022
wth (UNIX/PC job definition) 958

 **Hitachi, Ltd.**

6-6, Marunouchi 1-chome, Chiyoda-ku, Tokyo, 100-8280 Japan
